

CATÁLOGO DE HERRAMIENTAS,
MAQUINARIA Y REPUESTOS.



DIESEL INJECTION



Tuberías de Banco de Prueba

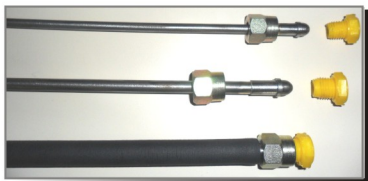

TUBERIAS DE 6 x 2 PARA COMMON RAIL

Codigo	Descripcion
im CR6 200 AA	TUBERÍA DE BCO. DE PRUEBA PARA COMMON RAIL 6 X 2 LARGO 200 mm - TUERCAS TIPO A/A
im CR6 200 AB	TUBERÍA DE BCO. DE PRUEBA PARA COMMON RAIL 6 X 2 LARGO 200 mm - TUERCAS TIPO A/B
im CR6 200 BB	TUBERÍA DE BCO. DE PRUEBA PARA COMMON RAIL 6 X 2 LARGO 200 mm - TUERCAS TIPO B/B
im CR6 300 AA	TUBERÍA DE BCO. DE PRUEBA PARA COMMON RAIL 6 X 2 LARGO 300 mm - TUERCAS TIPO A/A
im CR6 300 AB	TUBERÍA DE BCO. DE PRUEBA PARA COMMON RAIL 6 X 2 LARGO 300 mm - TUERCAS TIPO A/B
im CR6 300 BB	TUBERÍA DE BCO. DE PRUEBA PARA COMMON RAIL 6 X 2 LARGO 300 mm - TUERCAS TIPO B/B
im CR6 400 AA	TUBERÍA DE BCO. DE PRUEBA PARA COMMON RAIL 6 X 2 LARGO 400 mm - TUERCAS TIPO A/A
im CR6 400 AB	TUBERÍA DE BCO. DE PRUEBA PARA COMMON RAIL 6 X 2 LARGO 400 mm - TUERCAS TIPO A/B
im CR6 400 BB	TUBERÍA DE BCO. DE PRUEBA PARA COMMON RAIL 6 X 2 LARGO 400 mm - TUERCAS TIPO B/B
im CR6 500 AA	TUBERÍA DE BCO. DE PRUEBA PARA COMMON RAIL 6 X 2 LARGO 500 mm - TUERCAS TIPO A/A
im CR6 500 AB	TUBERÍA DE BCO. DE PRUEBA PARA COMMON RAIL 6 X 2 LARGO 500 mm - TUERCAS TIPO A/B
im CR6 500 BB	TUBERÍA DE BCO. DE PRUEBA PARA COMMON RAIL 6 X 2 LARGO 500 mm - TUERCAS TIPO B/B
im CR6 600 AA	TUBERÍA DE BCO. DE PRUEBA PARA COMMON RAIL 6 X 2 LARGO 600 mm - TUERCAS TIPO A/A
im CR6 600 AB	TUBERÍA DE BCO. DE PRUEBA PARA COMMON RAIL 6 X 2 LARGO 600 mm - TUERCAS TIPO A/B
im CR6 600 BB	TUBERÍA DE BCO. DE PRUEBA PARA COMMON RAIL 6 X 2 LARGO 600 mm - TUERCAS TIPO B/B
im CR6 700 AA	TUBERÍA DE BCO. DE PRUEBA PARA COMMON RAIL 6 X 2 LARGO 700 mm - TUERCAS TIPO A/A
im CR6 700 AB	TUBERÍA DE BCO. DE PRUEBA PARA COMMON RAIL 6 X 2 LARGO 700 mm - TUERCAS TIPO A/B
im CR6 700 BB	TUBERÍA DE BCO. DE PRUEBA PARA COMMON RAIL 6 X 2 LARGO 700 mm - TUERCAS TIPO B/B
im CR6 800 AA	TUBERÍA DE BCO. DE PRUEBA PARA COMMON RAIL 6 X 2 LARGO 800 mm - TUERCAS TIPO A/A
im CR6 800 AB	TUBERÍA DE BCO. DE PRUEBA PARA COMMON RAIL 6 X 2 LARGO 800 mm - TUERCAS TIPO A/B
im CR6 800 BB	TUBERÍA DE BCO. DE PRUEBA PARA COMMON RAIL 6 X 2 LARGO 800 mm - TUERCAS TIPO B/B

Tuberías de Banco de Prueba

im CR6 400 AD	Tubería de Banco de Prueba de 6x2 Largo 400 mm - Tuercas A y de 16x1
im CR6 500 AD	Tubería de Banco de Prueba de 6x2 Largo 500 mm - Tuercas A y de 16x1
im CR6 600 AD	Tubería de Banco de Prueba de 6x2 Largo 600 mm - Tuercas A y de 16x1
im CR6 700 AD	Tubería de Banco de Prueba de 6x2 Largo 700 mm - Tuercas A y de 16x1
im CR6 800 AD	Tubería de Banco de Prueba de 6x2 Largo 800 mm - Tuercas A y de 16x1
im CR6 900 AD	Tubería de Banco de Prueba de 6x2 Largo 900 mm - Tuercas A y de 16x1
im CR6 1000 AD	Tubería de Banco de Prueba de 6x2 Largo 1000 mm - Tuercas A y de 16x1

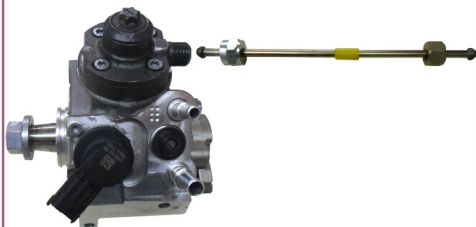

Tubería de Banco de Prueba
para Common Rail de Rampa a Bomba

VOLSKWAGEN AMAROK



CATÁLOGO DE HERRAMIENTAS, MAQUINARIAS Y REPUESTOS COMMON RAIL

CUADRO EXPLICATIVO DE CODIFICACIÓN



O'RINGS VARIOS

O'RINGS

XYZZ

01



→ CODIFICACIÓN

→ NÚMERO DE PÁGINA

X GRUPO	Y MARCA	ZZ PRODUCTO
1 COMMON RAIL	0 UNIVERSAL	00 UNIVERSAL
2 SISTEMA PDE	1 BOSCH	01 BOMBAS DE ALTA PRESIÓN COMPLETAS
3 SISTEMA PLD	2 DELPHI	02 KIT DE REPARACIÓN DE BOMBAS DE ALTA PRESIÓN
4 BOMBAS EDC	3 SIEMENS	03 VÁLVULAS REGULADORAS DE PRESIÓN / CAUDAL DE BOMBAS
6 HERRAMIENTAS	4 NIPON DENSO	04 ELEMENTOS
7 MAQUINARIAS		05 RETENES
		06 TAPAS DE BOMBAS
		07 BOMBAS DE BAJA PRESIÓN
		20 INYECTORES COMPLETOS
		21 KIT DE RAPARACIÓN DE INYECTORES
		22 TOBERAS
		23 PORTATOBERAS
		24 VÁSTAGOS DE INYECTOR
		25 VÁLVULAS PARA INYECTOR
		26 ARANDELAS DE CALIBRACIÓN DE INYECTOR
		27 RESORTES DE INYECTOR
		28 GRUPO MAGNÉTICO PARA INYECTORES
		40 RAMPAS
		41 VÁLVULAS REGULADORAS DE PRESIÓN DE RAMPAS
		42 VÁLVULAS SENSORAS DE PRESIÓN DE RAMPAS
		43 TUBERÍAS DE ALTA PRESIÓN
		44 VÁLVULAS LIMITADORAS DE PRESIÓN
		60 O'RINGS VARIOS
		61 ARANDELAS VARIAS
		62 RACORDS VARIOS
		63 BULONES Y TORNILLOS
		70 INYECTORES BOMBAS - PDE
		71 KIT DE REPARACIÓN DE INYECTORES BOMBA / PDE
		80 MONOBOMBAS - PLD
		81 KIT DE REPARACIÓN DE MONOBOMBAS / PLD
		90 PARA BOMBAS Y MONOBOMBAS
		91 PARA ARME Y DESARME DE INYECTORES
		92 PARA REPARACIÓN DE INYECTORES
		95 PARA CONTROL DE BOMBAS E INYECTORES COMMON RAIL
		96 PARA CONTROL DE SISTEMAS PLD Y PDE
		99 DESPIECES VARIOS

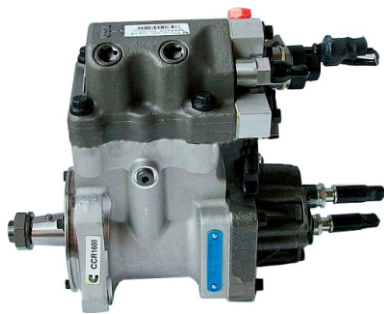
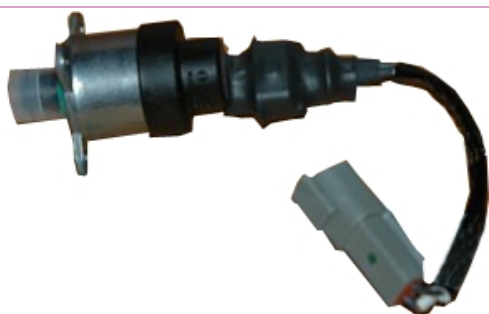
**cm1001-001****BOMBA DE ALTA PRESIÓN ORIGINAL CUMMINS****ISLe ISCe CCR1600****CUMMINS QSC 8.3****VOLSKWAGEN COSTELLATION V 19-330T-19/25/26 - 390T ISLe****FORD ISLe****CÓDIGO CUMMINS: 4088604 / 4921431 / 4921434 / 4954200 / 3973228****CÓDIGO VOLSKWAGEN: 2T2130105A****CODIGO FORD: BH1X 9A543AA****cm1003-001****VÁLVULA REGULADORA DE CAUDAL
DE BOMBA ORIGINAL CUMMINS ZME ISLe ISCe CCR1600****CUMMINS QSC 8.3****VOLSKWAGEN COSTELLATION V 19-330T-19/25/26 - 390T ISLe****FORD ISLe****CÓDIGO CUMMINS: 4903523****cm1007-001****BOMBA DE ENGRANAJE ORIGINAL CUMMINS****ISLe ISCe CCR1600****CUMMINS QSC 8.3****VOLSKWAGEN COSTELLATION V 19-330T-19/25/26 - 390T ISLe****FORD ISLe****CÓDIGO CUMMINS: 4088866****CÓDIGO VOLSKWAGEN: 2T2198119A****CÓDIGO FORD: BH0X9C545AA**



cm1099-001

**BOTADOR DE BOMBA ORIGINAL CUMMINS
ISLe ISCe CCR1600**

CUMMINS QSC 8.3
VOLSKWAGEN COSTELLATION V 19-330T-19/25/26 - 390T ISLe
FORD ISLe
CÓDIGO CUMMINS: 4921732



cm1099-002

**BOMBA DE TRANSFERENCIA ORIGINAL
CUMMINS ISLe ISCe - 24v**

CUMMINS QSC 8.3
VOLSKWAGEN COSTELLATION V 19-330T-19/25/26 - 390T ISLe
FORD ISLe
CÓDIGO CUMMINS: 5260634 - 3968190 - 3970198 - 3968189 - 4947999
KOMATSU 1317797H91

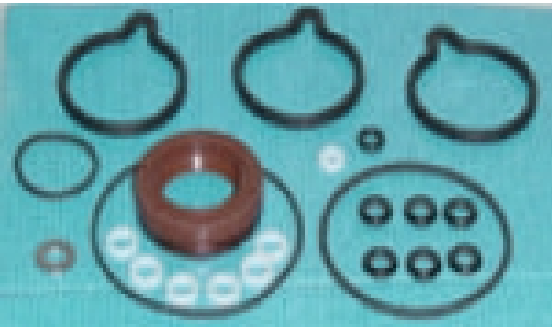
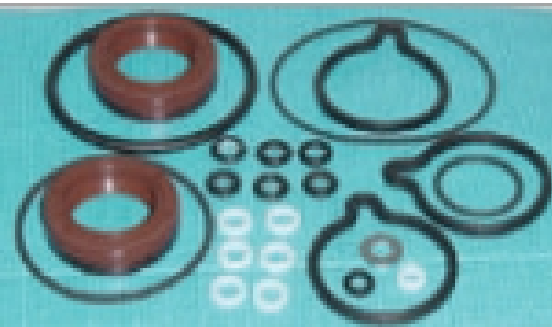
COMMON RAIL
BOSCH**cm1102-001****KIT DE O'RINGS Y RETENES 20x32x7**
CP3**cm1102-002****KIT DE O'RINGS Y RETENES 25x37x7**
CP3**cm1102-003****KIT DE O'RINGS**
CP3 110
CON RETENES Y BOLILLAS**cm1102-004****JUEGO DE JUNTAS**
CP1
SERIE I
CON RETÉN , VITON 20x31x7**cm1102-005****JUEGO DE JUNTAS**
CP1
IVECO DAILY
CON DOS RETENES (VITON 20x31x7) Y O'RING

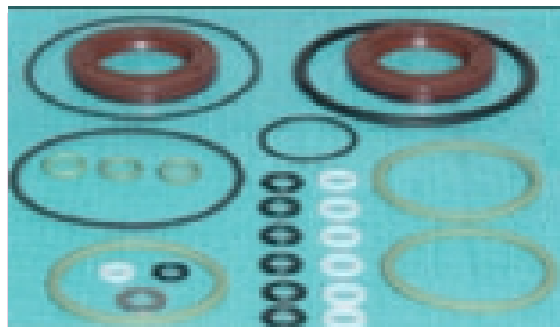
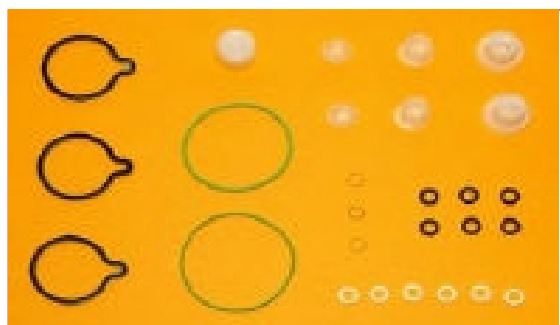
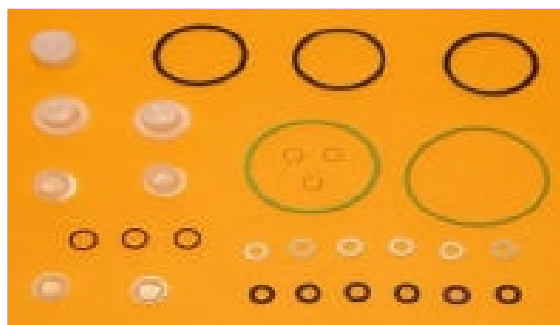
COMMON RAIL
BOSCH**cm1102-006****JUEGO DE JUNTAS**
CP1 (EVO)
IVECO - MERCEDES - KIA
CON RETENES**cm1102-007****JUEGO DE JUNTAS PARA CP1**
UNIVERSAL**cm1102-008****JUEGO DE JUNTAS**
CP1
BOSCH F.01M.100.278**cm1102-009****JUEGO DE JUNTAS**
CP1
BOSCH F.01M.100.275**cm1102-010****JUEGO DE JUNTAS**
CP1
BOSCH F.01M.100.276

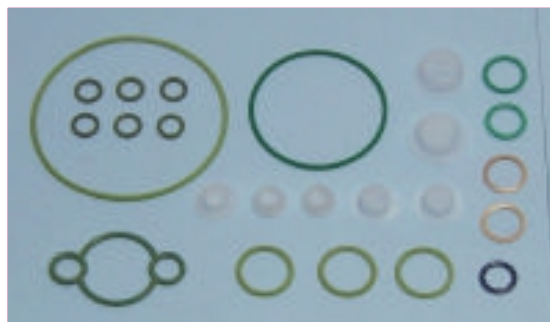
COMMON RAIL
BOSCH**cm1102-011****JUEGO DE JUNTAS**

CP3

CÓDIGO BOSCH: F.00N.201.973

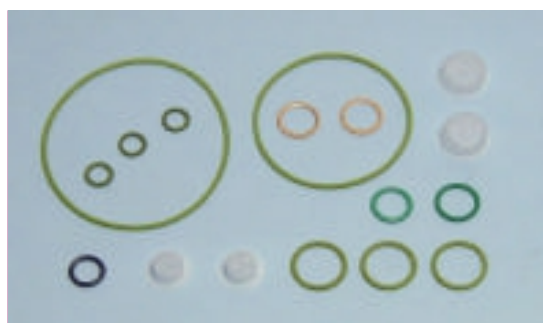
**cm1102-012****JUEGO DE JUNTAS**

CP3

CÓDIGO BOSCH: F.00N.201.977

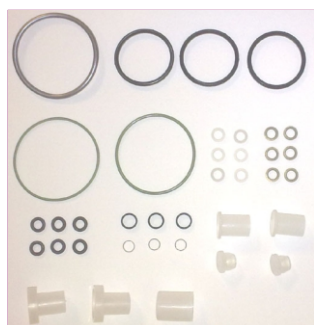
**cm1102-013****JUEGO DE JUNTAS**

CP1

CÓDIGO BOSCH: F 01M 100 277

**+F01M100275****JUEGO DE JUNTAS**

CP1

CÓDIGO BOSCH: F 01M 100 275

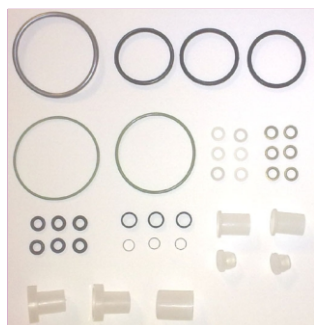
**+F01M100277****JUEGO DE JUNTAS**

CP1

CÓDIGO BOSCH: F 01M 100 277

cm1102-014

Juego de juntas para bomba Common Rail CP1H3 - Con filtro

RENAULT - FIAT - PEUGEOT - NISSAN**cm1102-015**

Teflón: 11mm



Juego de juntas para bomba Common Rail CP1H3

RENAULT - FIAT - PEUGEOT - NISSANCOMMON RAIL
BOSCH**cm1325-002**

Kit completo para reparación de inyector - 10 piezas

PEUGEOT 307/408 - CITROEN C3/C4 MOTOR 1.6 HDICOMMON RAIL
SIEMENS

COMMON RAIL
BOSCH

cm1103-481



Bosch
0928400481
0928400638
Iveco
42541851
Cummins
4937597

Válvula reguladora de presión / unidad de medición

IVECO - NEW HOLLAND

cm1103-728



Bosch
0928400726
0928400728
Fiat
71754810

Válvula reguladora de presión / unidad de medición
FIAT DOBLO MULTIJET 1.6/2.0 - FIAT DAILY / DUCATO 2.3
CITROEN JUMPER 2.3 - PEUGEOT BOXER 2.3

cm1103-736



Bosch
0928400736
0928400614

Válvula reguladora de presión / unidad de medición

CHEVROLET S10 / BLAZER 2.8 - 4.0TCE

cm1103-789



Bosch
0928400789

Válvula reguladora de presión / unidad de medición

VOLKSWAGEN CONTELLATION 13180/15180/26260/31260
8150/9150/17210 - MWM 4.12/6.12 TCE
VOLVO / AGRALE MWM 4.12 TCE



KIT DE REPARACIÓN DE BOMBAS DE ALTA PRESIÓN

HIGH PRESSURE PUMPS REPAIR KIT

1102

04

JR 155/112



KIT DE PROTECTORES PLÁSTICOS

CP1-CP3



ELEMENTOS

ELEMENTS

1104

01

COMMON RAIL
BOSCH

+F01M100075



ELEMENTO DE BOMBA

CP1

SPRINTER

CÓDIGO BOSCH: F 01M 100 075



RETENES

1105

01

COMMON RAIL
BOSCH

cm1105-002



RETEN RUEDA DE ENGRANAJE BOMBA RADIAL DE ÉMBOLOS COMMON RAIL

RENAULT MASTER 3.0 DCI 140

CHEVROLET S10 - BLAZER 2.8

CÓDIGO BOSCH: F00N202658

F00R0P0521

COMMON RAIL
BOSCH**+0445110076****INYECTOR COMPLETO**

PEUGEOT 206-307

CÓDIGO BOSCH: 0 445 110 076

+0445110189**INYECTOR COMPLETO**

MERCEDES BENZ 313 CDI

CÓDIGO BOSCH: 0 445 110 189

COMMON RAIL

cm1120-212**INYECTOR COMPLETO****CUMMINS ISB****FORD CARGO 1317****VOLKSWAGEN**

BOSCH: 0445 120 212

CUMMINS: 5255184

2830957

FORD: BG9X9K526BA

VW: 2R0198133

IVECO: 4896444

3230159500

2830224

COMMON RAIL
BOSCH**cm1121-001****KIT PARA INYECTOR COMMON RAIL (BOLITA/ORING JUNTA)**
CÓDIGO: 96 001 61**cm1121-002****KIT DE ARANDELAS**
PARA INYECTORES BOSCH COMMON RAIL
CÓDIGO: F00VC99002**JR 155/110****KIT DE PROTECTORES PLÁSTICOS**
PARA INYECTORES ELECTRÓNICOS
BOSCH, DENSO, SIEMENS**JR 155/113****KIT PARA INYECTOR BOSCH COMMON RAIL**
BOLITA DE 1,34mm**JR 155/114****KIT DE ARANDELAS**
PARA INYECTORES BOSCH COMMON RAIL
CÓDIGO: F00VC99002

JR 155/115



**KIT DE ARANDELA + O'RING
PARA INYECTORES BOSCH COMMON RAIL
CAMIÓN RENAULT 420/370 DCI
CÓDIGO: F00RJ01878**

**cm1122-196****TOBERA COMMON RAIL - DSLA142P795**
PEUGEOT / CITROEN 2.0 HDI**INYECTORES 04451100008**

CHEVROLET TRAKKER 2.0 HDI

CITROEN BERLINGO / XSARA / PICASSO 2.0 HDI

PEUGEOT 206/306/307/406/PARTNET 2.0 HDI

FIAT DUCATO 2.0 HDI

COD. BOSCH: 0433175196

**cm1122-271****TOBERA COMMON RAIL - DSLA143P970**
FORD CARGO C1317 - IVECO**INYECTORES 0445120007**

FORD CARGO C1317 ISBe4 3.9 / CARGO C1722 ISBe 5.9

VOLSKWAGEN 8150E ISBe4 3.9 / CONSTELLATION 17250 ISBe4 5.9

IVECO EUROARGO 3.9 - 5.9

CUMMINS ISBe4

COD. BOSCH: 0433175271

**cm1122-501****TOBERA COMMON RAIL - DSLA143P5501**
FORD CARGO C1317 - IVECO**INYECTORES 0445120212**

FORD CARGO C1317 ISBe4 3.9 / CARGO C1722 ISBe 5.9

VOLSKWAGEN 8150E ISBe4 3.9 / CONSTELLATION 17250 ISBe4 5.9

IVECO EUROARGO 3.9 - 5.9

CUMMINS ISBe4

COD. BOSCH: 0433175501

**cm1122-699****TOBERA COMMON RAIL - DLLA150P1076**
RENAULT PREMIUM 370 / 420 - IVECO**INYECTORES 0445120019 0445120020 0445120084**

RENAULT PREMIUM 370 / 420 DCI11E/C

COD. BOSCH: 0433171699

COD. RENAULT: 5600680090

**cm1122-811****TOBERA COMMON RAIL - DLLA 146P1296**
RENAULT MASTER 2.3 / 2.5**INYECTORES 0445110141**

RENAULT MASTER II M9T 2.3 / G9U 2.5

COD. BOSCH: 0433171811

**cm1122-914****TOBERA COMMON RAIL - DLLA149P1471**
PEUGEOT / CITROEN 1.6 HDI**INYECTORES 0445110239 0445110311**

CITROEN BERLINGO / C3 / C4 1.6 HDI

PEUGEOT 207 / 307 / PARTNET 1.6 HDI

SUZUKI SX4 1.6 HDI

FORD FIESTA / FOCUS 1.6 HDI

COD. BOSCH: 0433171914

PT 170/104[Ref. Original](#)

Portatobera

Carry nozzle

**PEUGEOT 207/307 2.0 HDI - INYECTOR 0 445 110 076
con TOBERA 0 433 175 431 (DSL142P1474)****PT 170/105**[Ref. Original](#)**Bosch
F00VC1401**

Portatobera

Carry nozzle

**CHEVROLET S10 - MOTOR 2.8 MWM P/ INYECTOR
0 445 110 231 con TOBERA 0 433 171 693 (DLLA148P1067)**

cm1125-C05**VÁLVULA DE TERCERA ETAPA BOSCH
RENAULT 1.9 DCI**

INYECTORES 0445110021 0445110146

RENAULT LAGUNA 1.9 DCI / MEGANE 1.9 DCI / SCENIC 1.9 DCI
COD. BOSCH: F00VC01005**cm1125-003****VÁLVULA DE TERCERA ETAPA BOSCH
PEUGEOT / CITROEN 2.0 HDI**

INYECTORES 0445110008 0445110020 0445110044 0445110062

PEUGEOT 206/306/307/406/PARTNER 2.0 HDI
CITROEN BERLINGO / XSARA / PICASSO 2.0 HDI
SUZUKI G.VITARA 2.0 HDI
FIAT DUCATO 2.0 HDI
COD. BOSCH: F00VC01003**cm1125-005****VÁLVULA DE TERCERA ETAPA BOSCH
PEUGEOT BOXER 2.8 HDI / FIAT DUCATO 2.8 / IVECO DAILY 2.8**

INYECTORES 0445120002

FIAT DUCATO 2.8
IVECO DAILY 2.8
PEUGEOT BOXER 2.8
COD. BOSCH: F00RJ00005**cm1125-022****VÁLVULA DE TERCERA ETAPA BOSCH
RENAULT MASTER 2.5 / LAGUNA 2.2 DCI**

INYECTORES 0445110084 0445110087 0445110102 0445110141

RENAULT MASTER 2.5 DCI
RENAULT LAGUNA II 2.2 DCI
COD. BOSCH: F00VC01022**cm1125-023****VÁLVULA DE TERCERA ETAPA BOSCH
CHEVROLET BLAZER / S10 2.8**

INYECTORES 0445110081 0445110125 0445110231 0445110336 0445110337

CHEVROLET BLAZER 2.8E - 4.07TCE
CHEVROLET S10 2.8E - 4.07TCE
NISSAN FRONTIER 2.8E - 4.07TCE
NISSAN XTERRA 2.8E - 4.07TCE
COD. BOSCH: F00VC01023

cm1125-033**VÁLVULA DE TERCERA ETAPA BOSCH****HYUNDAI - KIA 2.5****INYECTORES 0445110091 0445110092 0445110185 0445110186 0445110279****0445110283 0445110306****HYUNDAI H1 2.5****KIA SORENTO 2.5****COD. BOSCH: F00VC01033****cm1125-044****VÁLVULA DE TERCERA ETAPA BOSCH****HYUNDAI - KIA 2.5****INYECTORES 0445110064 0445110101 0445110126 0445110290****HYUNDAI ACCENT 1.5****HYUNDAI SANTA FE 2.0****KIA SPORTAGE 2.0****COD. BOSCH: F00VC01044****cm1125-051****VÁLVULA DE TERCERA ETAPA BOSCH****MERCEDES BENZ SPRINTER 311 / 411 CDI****INYECTORES 0445110181 0445110189 0445110200****0445110205 0445110207 0445110224****MERCEDES BENZ SPRINTER 211/311/313/411/413 OM611 2.2 CDI****MERCEDES BENZ 108/110/VITO OM611 2.2 CDI****COD. BOSCH: F00VC01051****cm1125-053****VÁLVULA DE TERCERA ETAPA BOSCH****PEUGEOT 2.0 HDI****INYECTORES 0445110076****CITROEN BERLINGO / XSARA / PICASSO 2.0 HDI****PEUGEOT 206 / 306 / 307 / 406 / PARTNET 2.0 HDI****FIAT DUCATO 2.0 HDI****COD. BOSCH: F00VC01053****cm1125-130****VÁLVULA DE TERCERA ETAPA BOSCH****FORD CARGO C1317E****INYECTORES 0445120059 0445120060 0445120123 0445120151 0445120152**
0445120208 0445120209 04451200210 0445120211 0445120212 0445120212**FORD CARGO C1317E / 1517E / F250 4BTAA****VOLSKWAGEN 8150E / CONSTELLATION 17250 ISBe4 - ISBe6****IVECO EURO CARGO 3.9 - 5.9****COD. BOSCH: F00RJ02130**

cm1125-306

VÁLVULA DE TERCERA ETAPA BOSCH
MERCEDES BENZ ML 270 E320 CDI
INYECTORES 0445110096 0445110142 0445110143 0445110153
0445110154 0445110214 0445110215

TOYOTA 1.4D
MERCEDES BENZ MI270 E320 CDI
COD.BOSCH: F00RJ01306

cm1125-334

VÁLVULA DE TERCERA ETAPA BOSCH
FIAT 1.3 JTD
INYECTORES 0445110183 0445110260 0445110309 0445110310 0445110316
0445110322 0445110331

FIAT LINEA / PUNTO 1.3 JTD
ALFA ROMEO MITO 1.3
FORD KA 1.3
COD. BOSCH: F00VC01334

cm1125-339

VÁLVULA DE TERCERA ETAPA BOSCH
FORD CARGO 1317E - IVECO EUROARGO
INYECTORES 0445120007 0445120018 0445120032 0445120079 0445120103

FORD CARGO C815 / 1317E / C1722E / C815 3.9 / 5.9
IVECO EUROARGO 3.9 / 5.9
VOLSKWAGEN 8150E ISBe4
CUMMINS ISBe4
COD. BOSCH: F00RJ00339

cm1125-346

VÁLVULA DE TERCERA ETAPA BOSCH
HYUNDAI - CHEVROLET - KIA
INYECTORES 0445110253 0445110254 0445110257 0445110258
0445110269 0445110270 0445110329 0445110330

HYUNDAI SANTA FE 2.2
HYUNDAI TUCSON / Li3 2.0
CHEVROLET CAPTIVA 2.0
KIA SPORTAGE 2.0
COD. BOSCH: F00VC01346

cm1125-349

VÁLVULA DE TERCERA ETAPA BOSCH
MAZDA BT-50 2.5 / 3.0
INYECTORES 0445110249 0445110250

MAZDA BT-50 2.5 / 3.0

COD. BOSCH: F00VC01349

cm 1125-359

VÁLVULA DE TERCERA ETAPA BOSCH
JC - CHANGFENG - DONGFENG
INYECTORES 0445110355 0445110412 0445110515

JAC
CHANGFENG
DONGFENG
COD. BOSCH: F00VC01359

cm 1125-399

VÁLVULA DE TERCERA ETAPA BOSCH
RENAULT PREMIUM
INYECTORES 0445120009 0445120010 0445120014
0445120015 0445120019 0445120020 0445120084

IVECO
RENAULT 420 - 370 PREMIUM L
COD. BOSCH: F00RJ00399

cm 1125-941

VÁLVULA DE TERCERA ETAPA BOSCH
FORD CARGO C2632E / VW 18320
INYECTORES 0445120029 0445120037 0445120070 0445120097 0445120120 0445120125
0445120140 1445120236 0445120240 0445120272

FORD CARGO C2632E / C2932E ISC 8.3
VOLSKWAGEN 18320 / CONSTELLATION 25320 ISC 8.3
CUMMINS ISC 8.3
COD. BOSCH: F00RJ01941

cm 1125-3xx

CABEZA DE VALVULA DE TERCERA ETAPA BOSCH UNIRVERSAL
INYECTORES 0445110...

COD. BOSCH: F00VC01013 / F00VC01331 / F00VC01334 / F00VC01336 / F00VC01338 / F00VC01341
F00VC01342 / F00VC01344 / F00VC01346 / F00VC01347 / F00VC01348 / F00VC01352 / F00VC01353
F00VC01354 / F00VC01355 / F00VC01357 / F00VC01358 / F00VC01359 / F00VC01360 / F00VC01363 / F00VC01364 / F00VC01365
F00VC01367 / F00VC01368 / F00VC01371 / F00VC01376 / F00VC01377 / F00VC01378 / F00VC01379 / F00VC01380 / F00VC01383

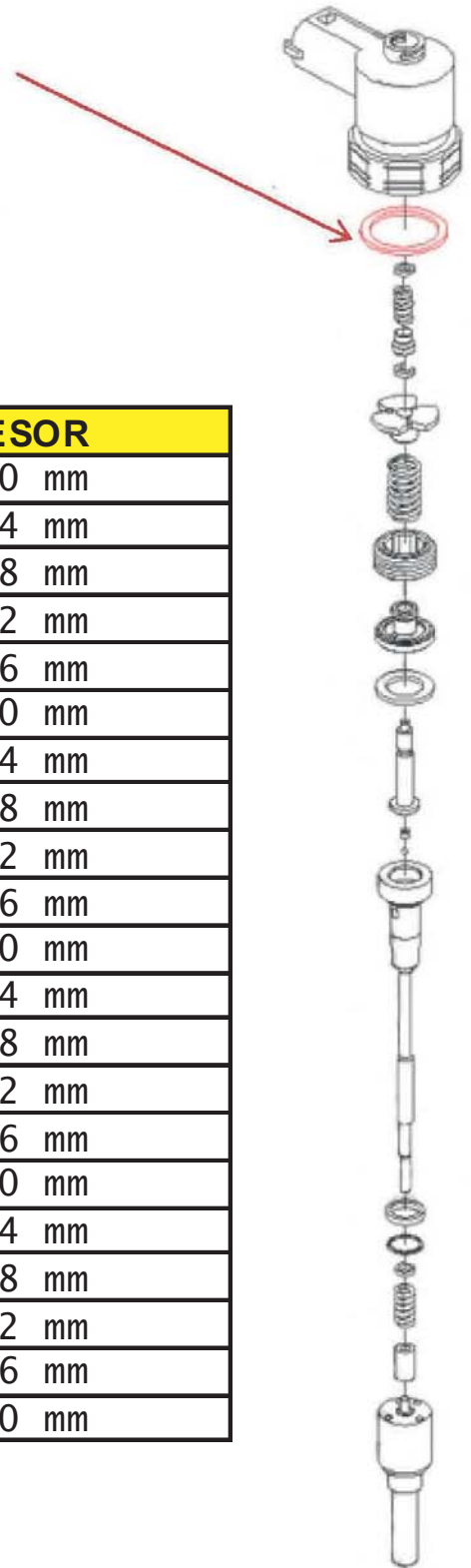
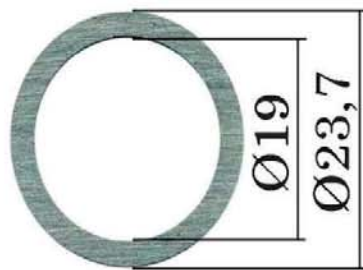

CODIGO CMD	CODIGO BOSCH	ESPESOR
cm1126-A1160	F00VC60325	1,160 mm
cm1126-A1164	F00VC60327	1,164 mm
cm1126-A1168	F00VC60329	1,168 mm
cm1126-A1172	F00VC60331	1,172 mm
cm1126-A1176	F00VC60333	1,176 mm
cm1126-A1180	F00VC60335	1,180 mm
cm1126-A1184	F00VC60337	1,184 mm
cm1126-A1188	F00VC60339	1,188 mm
cm1126-A1192	F00VC60341	1,192 mm
cm1126-A1196	F00VC60343	1,196 mm
cm1126-A1200	F00VC60345	1,200 mm
cm1126-A1204	F00VC60347	1,204 mm
cm1126-A1208	F00VC60349	1,208 mm
cm1126-A1212	F00VC60351	1,212 mm
cm1126-A1216	F00VC60353	1,216 mm
cm1126-A1220	F00VC60355	1,220 mm
cm1126-A1224	F00VC60357	1,224 mm
cm1126-A1228	F00VC60359	1,228 mm
cm1126-A1232	F00VC60361	1,232 mm
cm1126-A1236	F00VC60363	1,236 mm
cm1126-A1240	F00VC60365	1,240 mm

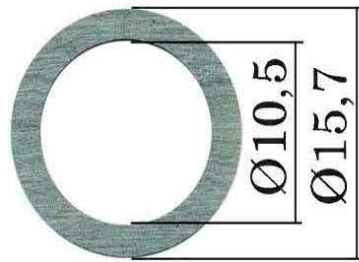

CODIGO CMD	CODIGO BOSCH	ESPESOR
cm1126-B1218	F00VC10414	1,218 mm
cm1126-B1222	F00VC10416	1,222 mm
cm1126-B1226	F00VC10418	1,226 mm
cm1126-B1230	F00VC10420	1,230 mm
cm1126-B1234	F00VC10422	1,234 mm
cm1126-B1238	F00VC10424	1,238 mm
cm1126-B1242	F00VC10426	1,242 mm
cm1126-B1246	F00VC10428	1,246 mm
cm1126-B1250	F00VC10430	1,250 mm
cm1126-B1254	F00VC10432	1,254 mm
cm1126-B1258	F00VC10434	1,258 mm
cm1126-B1262	F00VC10436	1,262 mm
cm1126-B1266	F00VC10438	1,266 mm
cm1126-B1270	F00VC10440	1,270 mm
cm1126-B1274	F00VC10442	1,274 mm
cm1126-B1278	F00VC10444	1,278 mm
cm1126-B1282	F00VC10446	1,282 mm
cm1126-B1286	F00VC10448	1,286 mm
cm1126-B1290	F00VC10450	1,290 mm
cm1126-B1294	F00VC10452	1,294 mm

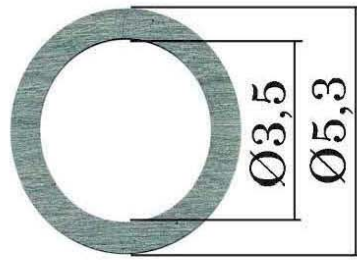

CODIGO CMD	CODIGO BOSCH	ESPESOR
cm1126-C120	F00VC10590	1,20 mm
cm1126-C122	F00VC10592	1,22 mm
cm1126-C124	F00VC10594	1,24 mm
cm1126-C126	F00VC10596	1,26 mm
cm1126-C128	F00VC10598	1,28 mm
cm1126-C130	F00VC10600	1,30 mm
cm1126-C132	F00VC10602	1,32 mm
cm1126-C134	F00VC10604	1,34 mm
cm1126-C136	F00VC10606	1,36 mm
cm1126-C138	F00VC10608	1,38 mm
cm1126-C140	F00VC10610	1,40 mm
cm1126-C142	F00VC10612	1,42 mm
cm1126-C144	F00VC10614	1,44 mm
cm1126-C146	F00VC10616	1,46 mm
cm1126-C148	F00VC10618	1,48 mm
cm1126-C150	F00VC10620	1,50 mm
cm1126-C154	F00VC10624	1,54 mm
cm1126-C158	F00VC10628	1,58 mm
cm1126-C162	F00VC10632	1,62 mm
cm1126-C166	F00VC10636	1,66 mm
cm1126-C170	F00VC10640	1,70 mm

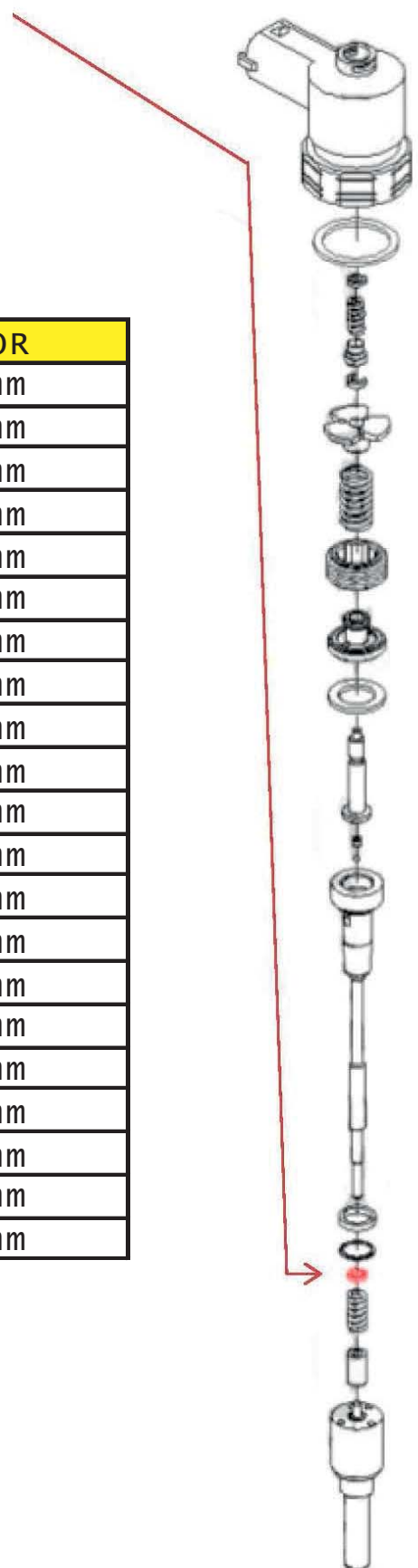

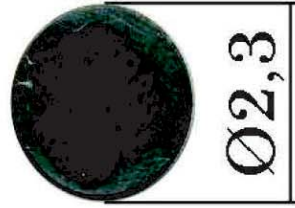

$\phi 2,3$

CODIGO CMD	CODIGO BOSCH	ESPE SOR
cm1126-G118	F00VC12536	1,18 mm
cm1126-G119	F00VC12538	1,19 mm
cm1126-G120	F00VC12540	1,20 mm
cm1126-G121	F00VC12542	1,21 mm
cm1126-G122	F00VC12544	1,22 mm
cm1126-G123	F00VC12546	1,23 mm
cm1126-G124	F00VC12548	1,24 mm
cm1126-G125	F00VC12550	1,25 mm
cm1126-G126	F00VC12552	1,26 mm
cm1126-G127	F00VC12554	1,27 mm
cm1126-G128	F00VC12556	1,28 mm
cm1126-G129	F00VC12558	1,29 mm
cm1126-G130	F00VC12560	1,30 mm
cm1126-G131	F00VC12562	1,31 mm
cm1126-G132	F00VC12564	1,32 mm
cm1126-G133	F00VC12566	1,33 mm
cm1126-G134	F00VC12568	1,34 mm
cm1126-G135	F00VC12570	1,35 mm
cm1126-G136	F00VC12572	1,36 mm

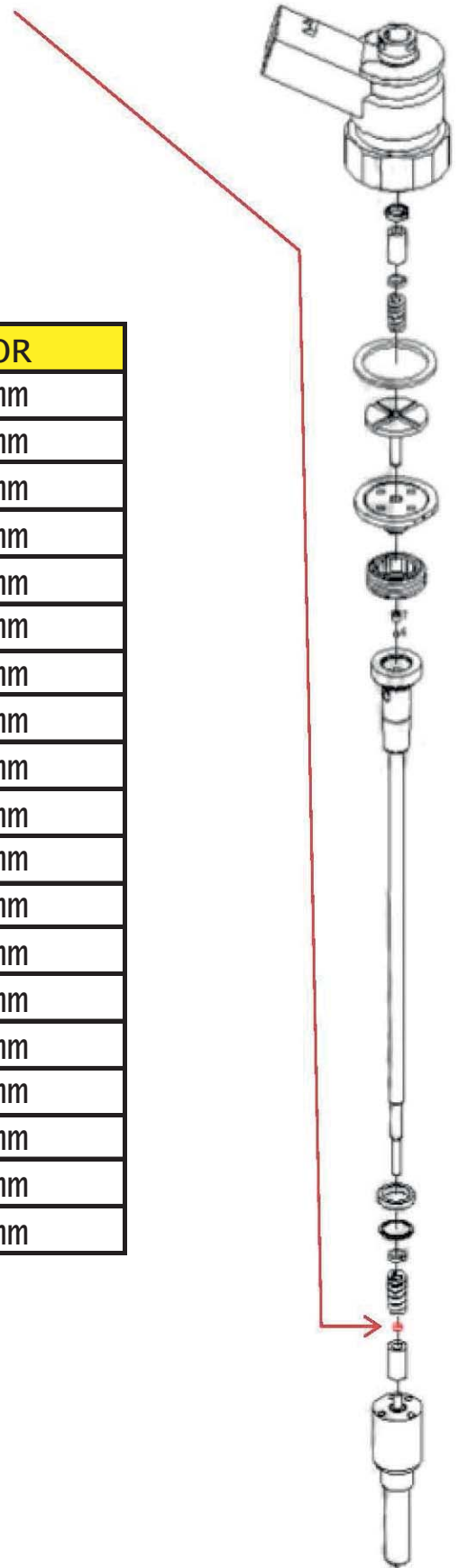

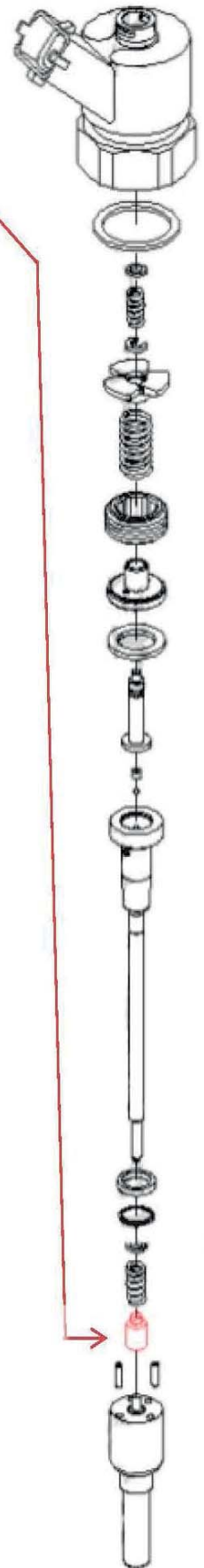

CODIGO CMD	CODIGO BOSCH	ESPESOR
cm1126-J8349	F00VC12324	8,349 mm
cm1126-J8361	F00VC12328	8,361 mm
cm1126-J8373	F00VC12332	8,373 mm
cm1126-J8385	F00VC12336	8,385 mm
cm1126-J8397	F00VC12340	8,397 mm
cm1126-J8409	F00VC12344	8,409 mm
cm1126-J8421	F00VC12348	8,421 mm
cm1126-J8433	F00VC12352	8,433 mm
cm1126-J8445	F00VC12356	8,445 mm
cm1126-J8457	F00VC12360	8,457 mm
cm1126-J8469	F00VC12364	8,469 mm
cm1126-J8481	F00VC12368	8,481 mm
cm1126-J8493	F00VC12372	8,493 mm

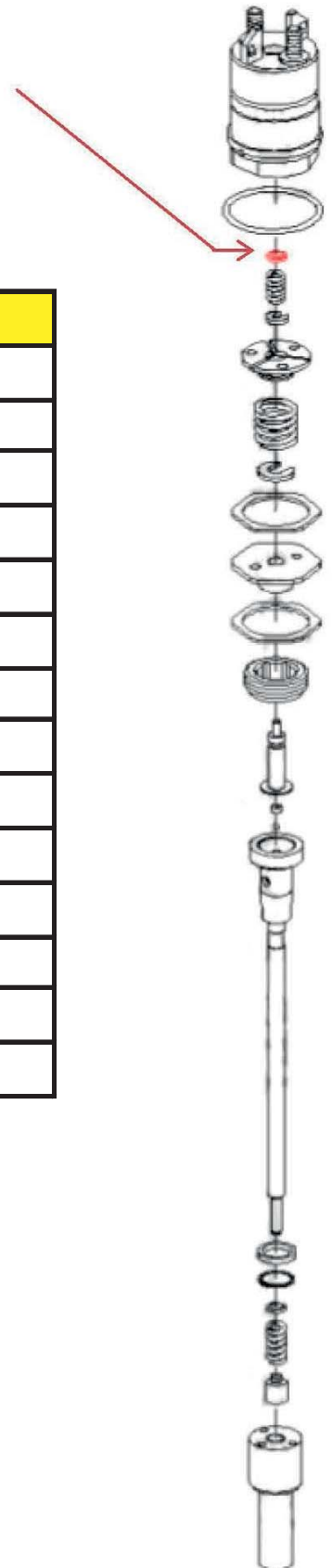
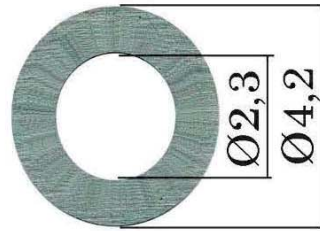

CODIGO CMD	CODIGO BOSCH	ESPESOR
cm1126-L092	F00RJ00189	0,92 mm
cm1126-L096	F00RJ00190	0,96 mm
cm1126-L100	F00RJ00191	1,00 mm
cm1126-L104	F00RJ00192	1,04 mm
cm1126-L108	F00RJ00193	1,08 mm
cm1126-L112	F00RJ00194	1,12 mm
cm1126-L116	F00RJ00195	1,16 mm
cm1126-L120	F00RJ00196	1,20 mm
cm1126-L124	F00RJ00197	1,24 mm
cm1126-L128	F00RJ00198	1,28 mm
cm1126-L132	F00RJ00199	1,32 mm
cm1126-L136	F00RJ00200	1,36 mm
cm1126-L140	F00RJ00201	1,40 mm
cm1126-L144	F00RJ00202	1,44 mm

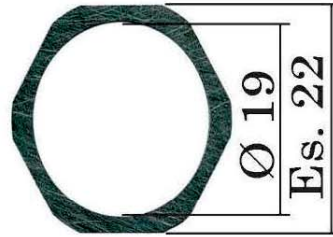

CODIGO CMD	CODIGO BOSCH	ESPESOR
cm1126-P124	F00RJ00126	1,24 mm
cm1126-P125	F00RJ00128	1,25 mm
cm1126-P126	F00RJ00130	1,26 mm
cm1126-P127	F00RJ00132	1,27 mm
cm1126-P128	F00RJ00134	1,28 mm
cm1126-P129	F00RJ00136	1,29 mm
cm1126-P130	F00RJ00138	1,30 mm
cm1126-P131	F00RJ00140	1,31 mm
cm1126-P132	F00RJ00142	1,32 mm
cm1126-P133	F00RJ00144	1,33 mm
cm1126-P134	F00RJ00146	1,34 mm
cm1126-P135	F00RJ00148	1,35 mm
cm1126-P136	F00RJ00150	1,36 mm

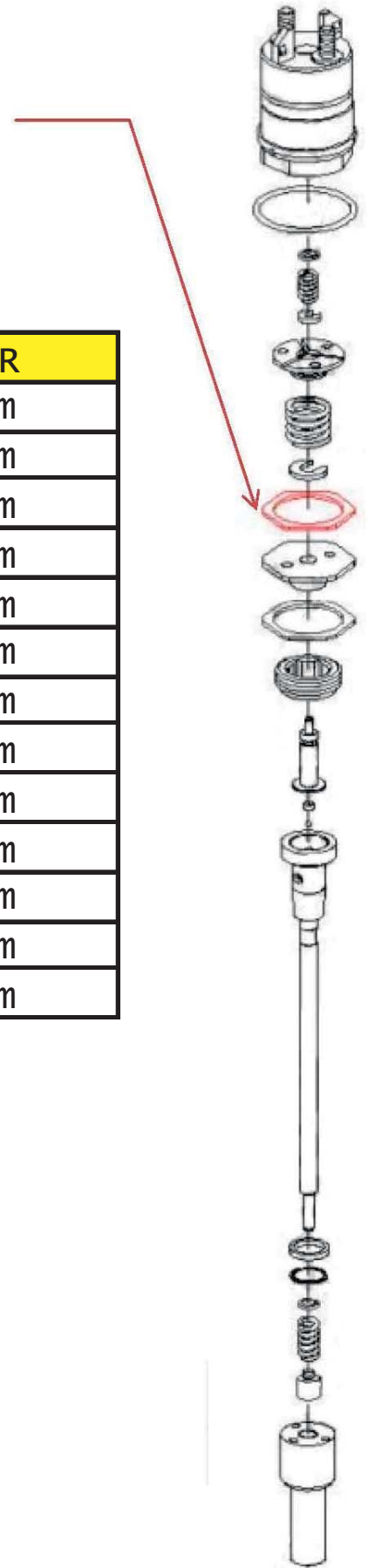

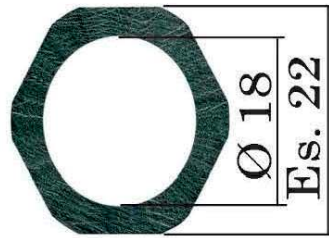

CODIGO CMD	CODIGO BOSCH	ESPESOR
cm1126-R0982	F00RJ00040	0,982 mm
cm1126-R0986	F00RJ00042	0,986 mm
cm1126-R0990	F00RJ00044	0,990 mm
cm1126-R0994	F00RJ00046	0,994 mm
cm1126-R0998	F00RJ00048	0,998 mm
cm1126-R1002	F00RJ00050	1,002 mm
cm1126-R1006	F00RJ00052	1,006 mm
cm1126-R1010	F00RJ00054	1,010 mm
cm1126-R1014	F00RJ00056	1,014 mm
cm1126-R1018	F00RJ00058	1,018 mm
cm1126-R1022	F00RJ00060	1,022 mm
cm1126-R1026	F00RJ00062	1,026 mm
cm1126-R1030	F00RJ00064	1,030 mm
cm1126-R1034	F00RJ00066	1,034 mm

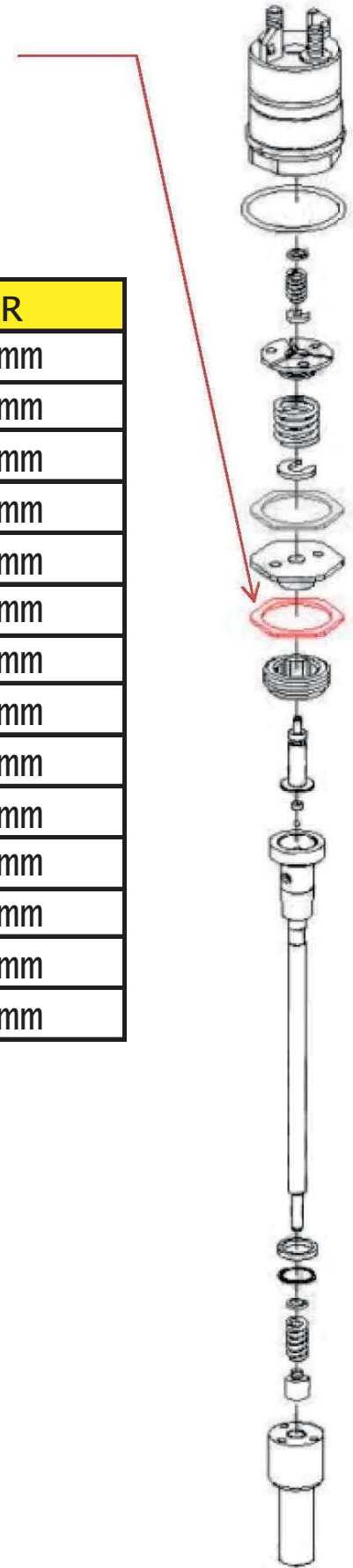



cm1128-697

GRUPO MAGNETICO (SOLENOIDE) PARA INYECTOR 0445120...

CRIN1 14/16

CÓDIGO BOSCH: F00RJ02697

**cm1141-003****VÁLVULA REGULADORA DE PRESIÓN****MERCEDES SPRINTER 208 - 211 - 213 - 216 - 308 - 311 - 313 - 316 - 408 - 411 - 413 - 416 - 616****MERCEDES A160 - A170 - Vaneo 17 - C270 - C30****CLK270 - E270 - G270 - ML270 - E320 - S320****CÓDIGO BOSCH: 0 281 002 241****CÓDIGO MERCEDES BENZ: 611 0780 149****cm1141-004****VÁLVULA REGULADORA DE PRESIÓN****MERCEDES VITO 108 - 110 - 112 / SPRINTER 208 - 211 - 213 - 216 - 308 - 311 313 - 316 - 408 - 411****413 - 416 - 616 / MERCEDES A160 - A170 C200 - C220 - C270 - C30 - CLK270 - E200 - E220 - E270****E320 - E400 - G270 - G400 - ML270 - ML400 - S320 - S400 - V200 - V220 / Vaneo 17****CÓDIGO BOSCH: 0 281 002 698****CÓDIGO MERCEDES BENZ: 611 0780 549**

COMMON RAIL
BOSCH**cm1141-001****VÁLVULA REGULADORA DE PRESIÓN**CITROËN BERLINGO 2.0 HDI / PEUGEOT 206 20cc HDI - 306 20cc HDI
406 20cc HDI - 806 20cc HDI
EXPERT 20cc HDI / PARTNER 20cc HDI
CÓDIGO BOSCH: 0 281 002 493**cm1141-002****VÁLVULA REGULADORA DE PRESIÓN**CITROËN BERLINGO 2.0 HDI / PEUGEOT 206 20cc HDI - 306 20cc HDI
406 20cc HDI - 806 20cc HDI
EXPERT 20cc HDI / PARTNER 20cc HDI
CÓDIGO BOSCH: 0 281 002 872**cm1141-003****VÁLVULA REGULADORA DE PRESIÓN**MERCEDES SPRINTER 208 - 211 - 213 - 216 - 308 - 311 - 313 - 316 - 408 - 411 - 413 - 416 - 616
MERCEDES A160 - A170 - Vaneo 17 - C270 - C30
CLK270 - E270 - G270 - ML270 - E320 - S320
CÓDIGO BOSCH: 0 281 002 241
CÓDIGO MERCEDES BENZ: 611 0780 149**cm1141-004****VÁLVULA REGULADORA DE PRESIÓN**MERCEDES VITO 108 - 110 - 112 / SPRINTER 208 - 211 - 213 - 216 - 308 - 311 313 - 316 - 408 - 411
413 - 416 - 616 / MERCEDES A160 - A170 C200 - C220 - C270 - C30 - CLK270 - E200 - E220 - E270
E320 - E400 - G270 - G400 - ML270 - ML400 - S320 - S400 - V200 - V220 / Vaneo 17
CÓDIGO BOSCH: 0 281 002 698
CÓDIGO MERCEDES BENZ: 611 0780 549**cm1141-005****VÁLVULA REGULADORA DE PRESIÓN**FIAT DUCATO 2,8 JTD / IVECO DAILY 2,8 JTD
RENAULT MASCOTTE 110 DCI
CÓDIGO BOSCH: 0 281 002 500
CÓDIGO FIAT: 994 832 54
CÓDIGO RENAULT: 50 01 848 538

COMMON RAIL
BOSCH**cm1141-006****VÁLVULA REGULADORA DE PRESIÓN**PEUGEOT 206 2.0 - CITROEN
CÓDIGO BOSCH: 0281002284**cm1141-007****VÁLVULA REGULADORA DE PRESIÓN**RENAULT LAGUNA / MEGANE / SCENIC
1.9 DCI / 1.9 DTI
CODIGO BOSCH: 0281002483
CODIGO RENAULT: 7701052268**cm1141-008****VÁLVULA REGULADORA DE PRESIÓN**BMW 330D / 525D / 530D / 730D / X5
CÓDIGO BOSCH: 0281002480
0281002287
CÓDIGO BMW: 13517787537
13512247845**cm1141-009****VÁLVULA REGULADORA DE PRESIÓN**ALFA ROMEO 159 1.9 JTD
ALFA ROMEO 156 2.4 JTD
FIAT
CÓDIGO BOSCH: 0281002488 - 0281002243
CÓDIGO FIAT: 71718445
60816659**cm1141-010****VÁLVULA REGULADORA DE PRESIÓN**HYUNDAI XTREE 2.0 CRDI
HYUNDAI TRAJET 2.0 CRDI
KIA TRAJET 2.0 CRDI
CÓDIGO BOSCH: 0281002718

COMMON RAIL
BOSCH



cm1141-011

VÁLVULA REGULADORA DE PRESIÓN

HYUNDAI SANTA FE 2.0
HYUNDAI TUCSON 2.0
HYUNDAI XTREK 2.0
HYUNDAI TRAJET XG VGT 2.0
KIA CARENS II 2.0
CÓDIGO BOSCH: 0281002445

cm1141-012



Bosch	Ford Livianos
0281002507	9S519C968AA
0281002508	1539570
Alfa Romeo	Hyundai
55185570	314022A400
Fiat Livianos	Renault Livianos
55185570	R901885026
51860694	Suzuki
51858110	15733M86J00
51819809	Toyota
51815371	232800N010

Válvula reguladora de presión

FORD KA 1.3 TDCI - FIAT 500/FIORINO/DOBLO/IDEA 1.3 MULTIJET
HYUNDAI H1 2.5 CRDi/i30 1.6 CRDI-2.0 CRDI/SANTA FE 2.2 CRDI

cm1141-013



Bosch
0281002494
0281002495
F00VF50202
Mercedes Benz Livianos
A6110780449
BMW
13537788685

Válvula reguladora de presión

MERCEDES BENZ E270 CDI T-MODELL MOTOR 2.7 - OM647.691
E280-E320-S320 CDI T-MODELL MOTOR 3.2 - OM648.691

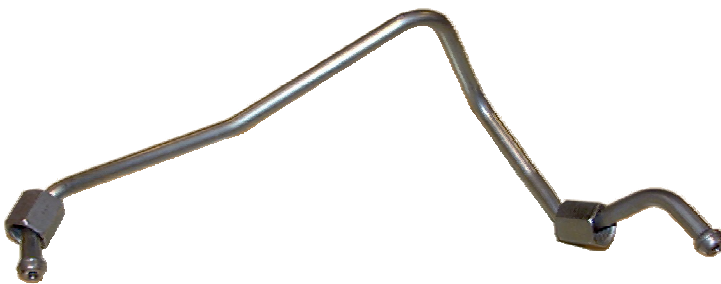
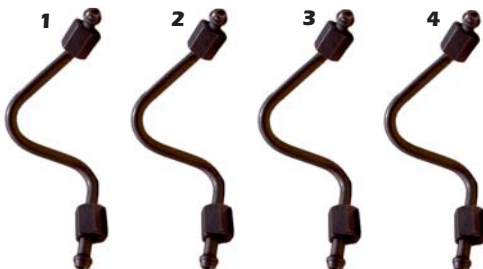
+0281002498**VÁLVULA SENSORA DE PRESIÓN**MERCEDES BENZ 313 CDI
CÓDIGO BOSCH: 0 281 002 498**G 6****TUBO DE ALTA PRESIÓN**DE BOMBA A RANPA
2.0 TDI
AMAROK
TIGUAN
PASSAT**G 7****JUEGO DE 4 TUBERIAS INYECCION**DE RAIL A INYECTOR
2.0 TDI
AMAROK
TIGUAN
PASSAT**M 31****TUBO DE ALTA PRESIÓN**DE BOMBA DE ALTA PRESIÓN A RAIL
MOTOR 611 LA
SPRINTER 313 CDI
CÓDIGO MB: A 611 070 14 33**M 32****TUBERIAS DE ALTA PRESIÓN**DE RAIL A INYECTOR
MOTOR 611 LA
SPRINTER 313 CDI
CÓDIGO MB: A 611 070 00 03

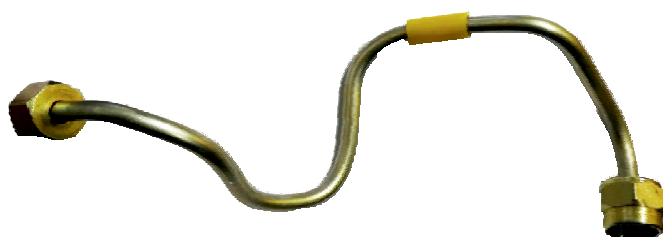
+0281002498**VÁLVULA SENSORA DE PRESIÓN**MERCEDES BENZ 313 CDI
CÓDIGO BOSCH: 0 281 002 498**FT 8****TUBO DE ALTA PRESIÓN**DE BOMBA A RAMPA
2.3 JTD
FIAT
DUCATO**G 6****TUBO DE ALTA PRESIÓN**DE BOMBA A RAMPA
2.0 TDI
AMAROK
TIGUAN
PASSAT**G 7****JUEGO DE 4 TUBERIAS INYECCION**DE RAIL A INYECTOR
2.0 TDI
AMAROK
TIGUAN
PASSAT**G 8****TUBO DE ALTA PRESIÓN**DE BOMBA A RAMPA
VW AMAROK/TIGUAN 2012 EN ADELANTE
MOTOR 2.0 - CNFA / CNEA / CSHA
CÓDIGO VW: A6110701433

U 26



6 TUBERIAS DE INYECCION

DE RAMPA A INYECTOR

MOTOR CUMMINS ISBe6

FORD 1722E

VOLSKWAGEN 17250

CÓDIGO CUMMINS: 1) 3965964 2) 2831356 3) 2830621

4) 2831356 5) 2830621 6) 3968346

CODIGO FORD: 1) BG5X 9A555BA 2y4) BG5X 9A556BA

3y5) BG5X 9A557AA 6) BG5X 9A558AA

U 27



TUBERIA DE INYECCION

DE BOMBA A RAMPA

MOTOR CUMMINS ISBe6

FORD 1722E

VOLSKWAGEN 17250

CÓDIGO CUMMINS: 3287880

CODIGO FORD: BG5X 9C520GA

U 28



JUEGO DE 6 TUBERIAS INYECCION

DE RAMPA A INYECTORES

CUMMINS ISBe6

2010 en adelante.



W 11

TUBERIAS DE ALTA PRESIÓN

DE RAMPA A INYECTOR

MOTOR 4,08E - CHEVROLET S10 - NISSAN

CÓDIGO MWM: 1- 940809060015

2- 940809060025

3- 940809060035

4- 940809060035

W 12



TUBERIAS DE INYECCION

DE BOMBA A RAMPA

DE RAMPA A INYECTOR

CHEVROLET - MWM - S10

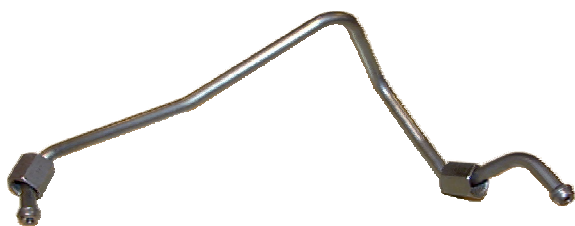

M 31

TUBO DE ALTA PRESIÓN
DE BOMBA DE ALTA PRESIÓN A RAIL
MOTOR 611 LA
SPRINTER 313 CDI
CÓDIGO MB: A 611 070 14 33

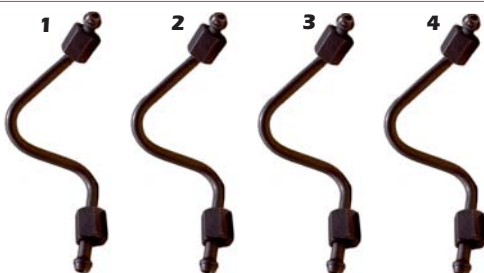

M 32

TUBERIAS DE ALTA PRESIÓN
DE RAIL A INYECTOR
MOTOR 611 LA
SPRINTER 313 CDI
CÓDIGO MB: A 611 070 00 03



U 26

6 TUBERIAS DE INYECCION
DE RAMPA A INYECTOR
MOTOR CUMMINS ISBe6
FORD 1722E
VOLSKWAGEN 17250
CÓDIGO CUMMINS: 1) 3965964 2) 2831356 3) 2830621
4) 2831356 5) 2830621 6) 3968346
CODIGO FORD: 1) BG5X 9A555BA 2y4) BG5X 9A556BA
3y5) BG5X 9A557AA 6) BG5X 9A558AA



U 27

TUBERIA DE INYECCION
DE BOMBA A RAMPA
MOTOR CUMMINS ISBe6
FORD 1722E
VOLSKWAGEN 17250
CÓDIGO CUMMINS: 3287880
CODIGO FORD: BG5X 9C520GA



U 28

JUEGO DE 6 TUBERIAS INYECCION
DE RAMPA A INYECTORES
CUMMINS ISBe6
2010 en adelante.



W 11

TUBERIAS DE ALTA PRESIÓN
DE RAMPA A INYECTOR
MOTOR 4,08E - CHEVROLET S10 - NISSAN
CÓDIGO MWM: 1- 940809060015
2- 940809060025
3- 940809060035
4- 940809060035



W 12

TUBERIAS DE INYECCION
DE BOMBA A RAMPA
DE RAMPA A INYECTOR
CHEVROLET - MWM - S10

VAL 221/36

18 x 1.5



Bosch
1110010035

Válvula limitadora de presión para rampa Common Rail
CUMMINS - IVECO EUROCARGO 100 E17
VOLSKWAGEN PESADO - FORD PESADO

VAL 221/37

18 x 1.5



Bosch
F00R000775
Cummins
4 899 831
Ford
BG5X 9F479 BA
Volkswagen
2R0 201 136 B

Válvula limitadora de presión para rampa Common Rail
CUMMINS - FORD - IVECO - VOLSKWAGEN

VAL 221/38

20 x 1.5



Válvula limitadora de presión para rampa common rail
CHEVROLET S10 / BLAZER 2.8 ELECTRONICO
PEUGEOT 206/307 1.4 HDI - KIA SORRENTO 2.5 CRDI
RENAULT LAGUNA/MEGANE/SCENIC 1.9 DCI - CITROEN XSARA 1.4 HDI

VAL 221/39

20 x 1.5



Bosch
1110010014
Case
162000090810
Man
51103040292

Válvula limitadora de presión para rampa common rail
MAN - CASE - NEW HOLLAND

VAL 221/40

20 x 1.5



Bosch
1110010019
Iveco
504043158

Válvula limitadora de presión para rampa common rail
RENAULT MASTER 2.5 DCI
RENAULT MEGANE II / SCENIC II 1.9 DCI - RENAULT LAGUNA II 2.2 DCI
CHEVROLET ASTRA 1.7 CDTI

VAL 221/41

20 x 1.5



Bosch
1110010027
Man
51103040358

Válvula limitadora de presión para rampa common rail
VOLKSWAGEN 5140 / 8150 MOTOR 3.0L - 4.08 TCE
AGRALE DEUTZ 8500 E-TRONIC MOTOR 3.0L - 4.08 TCE
VOLVO M310

VAL 221/42

20 x 1.5



Bosch
F00R000741

Válvula limitadora de presión para rampa common rail
RENAULT MASTER II 2.2 DCI - 2.5 DCI
RENAULT TRAFIC II 1.9 DCI
RENAULT LAGUNA II / ESPACE IV 2.2 DCI

COMMON RAIL
BOSCH

**AG 122/604**

O'RING
PARA INYECTOR BOSCH COMMON RAIL

AG 122/605

O'RING
PARA MONOBOMBA BOSCH PLD
MERCEDES BENZ OM904/906 ELECTRÓNICO

AG 122/606

O'RING
PARA MONOBOMBA BOSCH PLD
MERCEDES BENZ OM904/906 ELECTRÓNICO

AG 122/607

O'RING
PARA CÁNULA ENTRE TUBO INYECTOR E INYECTOR
MERCEDES BENZ OM904/906 ELECTRÓNICO
CÓDIGO: A541 997 06 45

AG 122/608

O'RING
PARA MONOBOMBA BOSCH PLD
MERCEDES BENZ OM904/906 ELECTRÓNICO
CÓDIGO: A541 997 05 45

COMMON RAIL
BOSCH

AG 122/609

O'RING
PARA MONOBOMBA BOSCH
SISTEMA PLD
CÓDIGO BOSCH: A023 997 68 48

AG 122/610

O'RING
PARA INYECTOR BOSCH COMMON RAIL
CAMION RENAULT 420/370 DCI
CÓDIGO BOSCH: F 00R J01 878

AG 122/611

O'RING
PARA VALVULA REGULADORA DE PRESION
CITROEN RENAULT PEUGEOT
CÓDIGO BOSCH: F 00V D38 010

+F00R0P0085

O'RING
PARA TAPA DE BOMBA CP1
CÓDIGO BOSCH: F 00R 0P0 085

AH 115/501

5x10x1mm

ARANDELA DE HIERRO
PARA RACORD. SALIDA INYECTOR BOSCH COMMON RAIL
F.00V.C17.002**AH 115/502**

8x10x0,6 (e=0,2 mm)

ARANDELA CON PESTAÑA DE ACERO
PARA INYECTOR BOSCH COMMON RAIL
F.00V.C17.105**AF 115/503**

8,25x10,25x1,5 mm

ARANDELA (PTFE + BRONCE)
PARA INYECTORES COMMON RAIL
BOSCH F.00V.C04.049**AC 115/504****ARANDELA DE COBRE**
PARA INYECTORES BOSCH COMMON RAIL
CAMIÓN RENAULT 420/370 DCI**cm1161-004****Bosch**
1987972076

Arandela asiento inyector Bosch

MERCEDES BENZ CDI

COMMON RAIL
BOSCH



cm1162-001

CONEXIÓN, SIN FILTRO

PARA CP1/K3

ZINCADO

MEDIDAS DE ROSCAS M12x1,5 - M12x1

BOSCH F.00R.0P0.471



cm1162-002

CONEXIÓN DE LATÓN, Ø 10mm.

PARA CP1

BOSCH F.00R.0P0.623

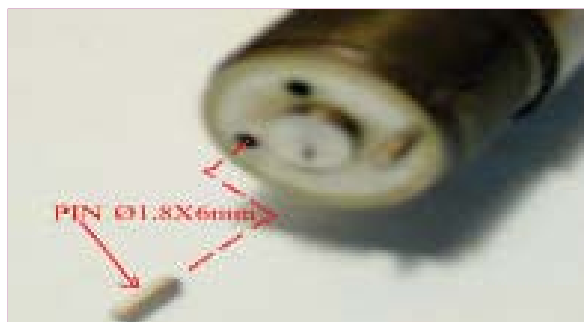
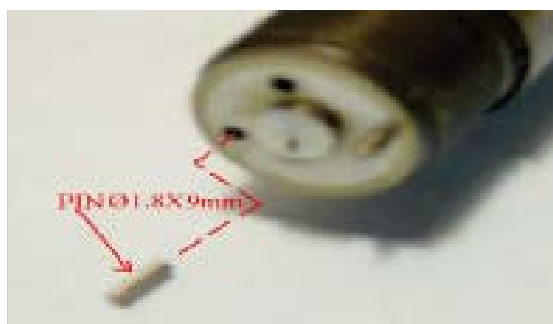
COMMON RAIL
BOSCH**cm1199-001****KIT DE 50 BOLILLAS Ø 1,34mm.**
CARBURO DE SILICIO**cm1199-002****PERNOS CILÍNDRICOS PARA**
INYECTORES COMMON RAILØ 1,8x6mm.
CÓDIGO BOSCH: 2 433 201 024**cm1199-003****PERNOS CILÍNDRICOS PARA**
INYECTORES COMMON RAIL

Ø 1,8x9mm.

**cm1199-004****CONEXIÓN PARA RETORNO DE COMBUSTIBLE**
PARA TUBERÍA 4mm.**cm1199-005****CONEXIÓN PARA RETORNO DE COMBUSTIBLE**
PARA TUBERÍA 4mm.

COMMON RAIL
BOSCH**cm1199-006****BOLILLAS DE ACERO**

Ø 1,50mm.

PARA VÁLVULA DE INYECTOR BOSCH COMMON RAIL
F00VC05006**BA 128/5****BOLILLAS DE ACERO**

Ø 1,34mm.

PARA VÁLVULA DE INYECTOR BOSCH COMMON RAIL
F00VC05001**BA 128/6****BOLILLAS DE ACERO**

Ø 1,35mm.

PARA VÁLVULA DE INYECTOR BOSCH COMMON RAIL

CP 134/26**PROTECTOR**PARA ENCHUFE DE INYECTOR ELECTRÓNICO
Y BOMBA DE ALTA PRESIÓN**CP 134/27****PROTECTOR**

PARA INYECTOR DELPHI ELECTRÓNICO

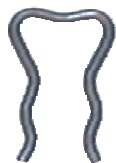
COMMON RAIL
BOSCH**CP 134/28****PROTECTOR
PARA INYECTOR ELECTRÓNICO****+F00R0P1114****ÁRBOL EXCENTRICO**
CP1
CÓDIGO BOSCH: F 00R 0P1 114**+F01M100684****TORNILLO PARA BOMBA**
CP1
CÓDIGO BOSCH: F 01M 100 684**SV 190/31****SEGURO DE SUJECION PARA
RETORNO DE INYECTORES**
CÓDIGO BOSCH: F 00V C22 003**cm1199-008****CANULA DE INYECTOR
CUMMINS CR
IVECO EUROARGO**
CÓDIGO BOSCH: F00RJ00414 - F00RJ00319 - F00RJ01280
CODIGO CUMMINS: 4897114 - 4893736
CODIGO IVECO: 504100835

COMMON RAIL
DELPHI

cm1202-001



Delphi
7135-479A
7135-539

Juego de juntas

RENAULT CLIO/KANGOO/MEGANE K9K
FORD FOCUS C-MAX 1.6/1.8 TDCI



INYECTORES COMPLETOS

COMPLETE INJECTORS

1220

01

COMMON RAIL
DELPHI

EJBR04001D



INYECTOR COMPLETO
RENAULT MEGANE 1.5 DCI MOTOR K9K
CÓDIGO DELPHI: EJBR04001D

EJBR04101D



INYECTOR COMPLETO
RENAULT CLIO 1.5 DCI MOTOR K9K
CÓDIGO DELPHI: EJBR04101D



PORTATOBERAS

NOZZLE NUT CAPS

1223

01

COMMON RAIL
DELPHI

cm1223-001



TUERCA PORTATOBERA C/R DELPHI
CÓDIGO: 98 100 96

PT 170/95



PORTATOBERA
FORD FOCUS CON INYECTOR DELPHI 2701
PARA TOBERA 79PBD

COMMON RAIL
DELPHI

PT 170/96



PORTATOBERA
FOCUS DELPHI ELECTRÓNICO
TOBERA L 12 PBD A 1601

PT 170/97



PORTATOBERA
RENAULT CLIO
DELPHI ELECTRÓNICO

COMMON RAIL
DELPHI**da9308-621C****VÁLVULA PARA INYECTOR COMMON RAIL**
COD. DELPHI 9308-621C (ALTERNATIVO)**dd9308-621C****VÁLVULA PARA INYECTOR COMMON RAIL**
DELPHI 9103-621C
CÓDIGO: 96 001 6004COMMON RAIL
DELPHI**dd9308-401B****RESORTE INYECTOR COMMON RAIL DELPHI**
CÓDIGO: 96 001 6030**dd9308-402B****RESORTE INYECTOR COMMON RAIL DELPHI**
CÓDIGO: 96 001 6035

COMMON RAIL
DELPHI**nl E 8****TUBERIA DE INYECCION COMMON RAIL**
DE BOMBA A FLAUTA
FORD FOCUS 1.8 TDCI**TF 9****JUEGO DE TUBOS DE ALTA PRESIÓN**
DE RAMPA (RIEL) A INYECTOR
RENAULT SANDERO/CLIO II/MEGANE II
LOGAN - MOTOR K9K 1.5 DCI**TF 10****TUBO DE ALTA PRESIÓN**
DE BOMBA A RAMPA (RIEL)
RENAULT SANDERO/CLIO II/MEGANE II
LOGAN - MOTOR K9K 1.5 DCICOMMON RAIL
DELPHI**AC 112/61****ARANDELA DE COBRE**
RENAULT SANDERO/CLIO II/MEGANE II
LAGUNA II/LOGAN - MOTOR K9K
CÓDIGO: 7703062072



KIT DE REPARACIONES DE BOMBAS DE ALTA PRESIÓN

HIGH PRESSURE PUMPS REPAIR KIT

1302

01

COMMON RAIL
SIEMENS



cm1302-001

**JUEGO DE JUNTAS
PARA BOMBA SIEMENS**



VALVULAS REGULADORAS DE PRESION SIEMENS

1303

01

COMMON RAIL
SIEMENS



cm1303-001

**VALVULA REGULADORA DE PRESION BOMBA COMMON RAIL
TIPO SIEMENS**

PEUGEOT 306-307
FORD FIESTA / ECOSPORT 1.4 HDI
CITROEN HDI C3 - C4 - C5 - PICASSO - XSARA - BERLINGO
CÓDIGO VDO: A2C59506225
CÓDIGO SIEMENS: X39-800-300-005Z
S5WX39005Z

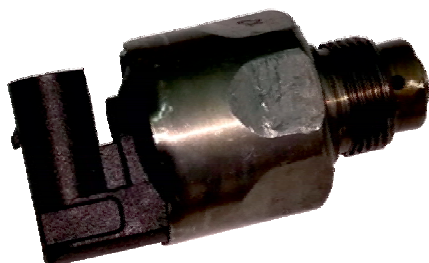

cm1303-002

**VALVULA REGULADORA DE PRESION BOMBA COMMON RAIL
TIPO SIEMENS - CONECTOR L**
FORD RANGER 3.0 POWER STROKE

CÓDIGO VDO: A2C20000704



cm1303-003

**FICHA DE REEMPLAZO PARA ADAPTAR VÁLVULA
TIPO SIEMENS - DE RECTA A 90°**
FORD RANGER 3.0 POWER STROKE

da 77550

**INYECTOR COMMON RAIL**
FORD RANGER 3.0 ELECTRÓNICO**PORTATOBERAS**

NOZZLE NUT CAPS

1323

01

COMMON RAIL
SIEMENS

PT 170/88

**PORTATOBERA**
FORD RANGER 3.0 ELECTRÓNICO
TOBERA M 1600 P 150 782

PT 170/100

**PORTATOBERA**
CITROËN C3 C/ TOBERA PM 0604
FORD FIESTA - ECOSPORT C/ TOBERA PV 0605 (INYECTOR SIEMENS)



VÁLVULA SENSORA DE PRESIÓN DE RAMPAS

RAIL PRESSURE SENSOR

1325
01

COMMON RAIL
SIEMENS

cm1325-001

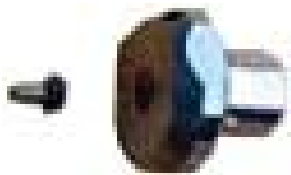

VÁLVULA PARA INYECTOR SIEMENS
(DOS PIEZAS)



RAMPA

RAIL

1340
01

COMMON RAIL
SIEMENS

cm1340-001

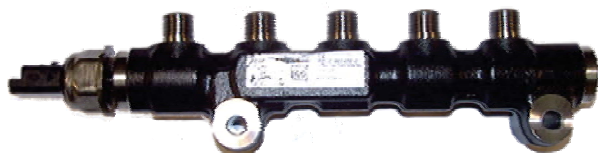

RAMPA CON SENSOR

CITROËN BERLINGO HDI 1.6

PEUGEOT 307 HDI 1.6

FORD TDCI 1.6

CÓDIGO SIEMENS: 965 459-0

CÓDIGO SENSOR: 6PH 1001



VÁLVULA SENSORA DE PRESIÓN DE RAMPAS

RAIL PRESSURE SENSOR

1342
01

COMMON RAIL
SIEMENS

ds5WS40039



VÁLVULA SENSORA DE PRESIÓN

FORD RANGER 3.0

CÓDIGO SIEMENS: 5WS40039



CONECTORES PLASTICOS

1399
01

COMMON RAIL
SIEMENS

cm1399-001



CONECTOR PLASTICO PARA RETORNO DE INYECTORES SIEMENS

FORD RANGER 3.0

FORD FIESTA 1.4/ECOSPORT 1.4

CITROËN C3/C4

E 12



JUEGO DE 4 TUBERIAS INYECCION
DE INYECTOR A RAMPA
FORD RANGER 3.0

cm1402-001**Denso**
294009-0030
294009-0031

Juego de juntas universal

TOYOTA - NISSANCOMMON RAIL
NIPON DENSO**cm1403-001****Denso**
04226-0L010
294200-0040

Válvula reguladora de presión

TOYOTA REFORMA - DENSO**cm1403-002****Mitsubishi**
294200-0360
294009-0250
294009-0251
294200-0300

Válvula reguladora de presión - Denso

TOYOTA - MITSUBISHI L200
NISSAN NP300 - MAZDA**cm1403-002A****Mitsubishi**
294200-0360
294009-0250
294009-0251
294200-0300

Válvula reguladora de presión - DMB

TOYOTA - MITSUBISHI L200
NISSAN NP300 - MAZDACOMMON RAIL
NIPON DENSO

COMMON RAIL
NIPON DENSO

dn23670-0L050



INYECTOR COMPLETO

TOYOTA 3.0

CÓDIGO DENSO: 23670-0L050

COMMON RAIL
NIPON DENSO**cm1422-006****TOBERA COMMON RAIL
TOYOTA HILUX 3.0 - 3ra Generación - G3S6
INYECTORES 23670-0L090 23670-30400**TOYOTA HILUX 3.0
COD. DENSO: G3S6**cm1422-007****TOBERA COMMON RAIL
TOYOTA HILUX 2.5 - 3ra Generación - G3S7
INYECTORES 23670 - 0L100**TOYOTA HILUX 2.5
COD. DENSO: G3S6**cm1422-033****TOBERA COMMON RAIL
TOYOTA HILUX 2.5 - 3ra Generación - G3S33
INYECTORES 23670 - 30420**TOYOTA HILUX 2.5
COD. DENSO: G3S33**cm1422-700****TOBERA COMMON RAIL - DLLA145P870
MITSUBISHI L200
INYECTORES 095000-5600**MITSUBISHI L200 4D56
COD. DENSO: 093400-8700**cm1422-024****TOBERA COMMON RAIL - DSLA145P1024
TOYOTA HILUX 2.5
INYECTORES 095000-7761 23670-30300 23670-0L070**TOYOTA HILUX 2.5
COD. DENSO: 093400-1024

**cm1422-480****TOBERA COMMON RAIL - DLLA155P848**
NISSAN
INYECTORES 095000-6353

COD. DENSO: 093400-8480

**cm1422-470****TOBERA COMMON RAIL - DLLA152P947**
CHEVROLET S10 - NISSAN FRONTIER
INYECTORES 095000-6250

COD. DENSO: 093400-9470

**cm1422-640****TOBERA COMMON RAIL - DLLA145P864**
TOYOTA HILUX 2.5
INYECTORES 095000-5931 23670-0L010

TOYOTA HILUX 2.5

COD. DENSO: 093400-8640

**cm1422-630****TOBERA COMMON RAIL - DLLA155P863**
TOYOTA HILUX 3.0
INYECTORES 095000-5921 23670-0L020

TOYOTA HILUX 3.0

COD. DENSO: 093400-8630

**cm1422-720****TOBERA COMMON RAIL - DLLA148P872**
NISSAN FRONTIER
INYECTORES 095000-5650

NISSAN FRONTIER

COD. DENSO: 093400-8720



PORTATOBERAS

NOZZLE NUT CAPS

1423

01

COMMON RAIL
NIPON DENSO



cm1423-001

TUERCA PORTATOBERA C/R DENSO

CÓDIGO: 96 001 6107



VALVULAS PARA INYECTOR

NOZZLE NUT CAPS

1425

01

COMMON RAIL
NIPON DENSO



cm1425-005

VÁLVULA PLAQUETA DE INYECTOR COMMON RAIL

TOYOTA HILUX 3.0

INYECTORES 095000-8290 095000-5050 095000-5150 095000-5160 095000-5190
095000-5230 095000-6700 095000-8011

COD. DENSO: ND5051-5



cm1425-009

VÁLVULA PLAQUETA DE INYECTOR COMMON RAIL

TOYOTA HILUX 2.5

INYECTORES 095000-5086 095000-5550 095000-5801 095000-5810
095000-7731 095000-7761 095000-7581

COD. DENSO: ND5051-9

COMMON RAIL
NIPON DENSO

cm1442-6121



Denso
499000-6121
Toyota
89458-71010

Sensor de presión de combustible para riel

TOYOTA PRADO/HIACE/HILUX 3.0 D4D

cm1442-6131

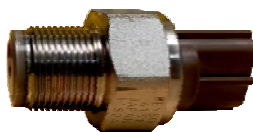

Denso
499000-6131
499000-6160
Isuzu
8981197900

Sensor de presión de combustible para riel

TOYOTA 1KD - 2KD
NISSAN NAVARA D40 / ISUZU

cm1442-6141

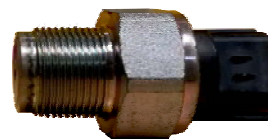

Denso
499000-6141
499000-6160

Sensor de presión de combustible para riel

ISUZU

T2

[Ref. Original](#)



Juego de 4 tuberías de Inyeccion
Toyota Hilux 2.5 y 3.0 Electronico

T2

Ref. Original



Juego de 4 tuberías de Inyeccion
Toyota Hilux 2.5 y 3.0 Electronico

cm1444-0670



Denso
095420-0670
095420-0280

Válvula limitadora de combustible para riel
TOYOTA PRADO / HIACE / HILUX



O'RINGS

VARIOUS WASHER

1460
01

AG 122/613



O'ring externo de cuerpo de inyector Denso Common Rail

TOYOTA - NISSAN - MITSUBISHI

COMMON RAIL
NIPPON DENSO



ARANDELAS VARIAS

VARIOUS WASHER

1461
01

AH 112/66



[Ref. Original](#)

Arandela de Hierro biselada para asiento de inyector Common Rail Toyota Hilux 3.0 / 2.5

VS

AC 115/97

8 x 13 x 1 mm

[Ref. Original](#)



Toyota
9094-30013

Arandela doble retorno Common Rail
Toyota Hilux1-2KDFTV

VS

COMMON RAIL
NIPPON DENSO



Despieces Varios

Various Despieces

1499
01

COMMON RAIL
NIPPON DENSO

cm1499-001



MICROFILTRO PARA INYECTOR COMMON RAIL

TOYOTA 2.5 / 3.0
CÓDIGO: 095229-0010

SISTEMA PDE
BOSCH

PT 170/102



VOLKSWAGEN

KIT PDE BORA / GOLF 1.9 TDI ASZ / ARL

KIT PDE VW BORA 1.9 TDI C/MOTOR

KIT PDE BORA C/MOT.AXR/GLOF 1.9 TDI / PASSAT (DSL A 150 P 1247)

KIT PDE VW BORA / PASSAT 1.9 TDI C/MOTOR AVF/ AWX (DSL A 150 P 1248)

CODIGO: 1 410 497 042

SISTEMA PDE
BOSCH



AG 122/600

O'RING
PARA INYECTOR BOMBA SISTEMA PDE - DE VITÓN



AG 122/601

O'RING
PARA INYECTOR BOMBA SISTEMA PDE - DE VITÓN



AG 122/602

O'RING
PARA INYECTOR BOMBA SISTEMA PDE - DE VITÓN

SISTEMA PDE
BOSCH**cm2171-001****KIT INYECTOR BOMBA BOSCH IVECO CURSOR 10-13 430CV**

CÓDIGO: 96 004 0312

cm2171-002**KIT DE O'RINGS, EXTERNO**PDE100 - 110
ATEGO**cm2171-003****KIT DE O'RINGS, EXTERNO**PDE100 - 110
ACTROS**cm2171-004****KIT DE O'RINGS, EXTERNO**PDE90
VOLVO**cm2171-005****KIT DE O'RINGS, EXTERNO**PDE
VOLVO FH 12 460 HP
BOSCH F.00V.X99.992

SISTEMA PDE
BOSCH**cm2171-006****KIT DE O'RINGS, EXTERNO**
PDE90
SCANIA**cm2171-007****KIT DE O'RINGS, EXTERNO**
PDE DELPHI**cm2171-008****KIT DE O'RINGS, EXTERNO**
PDE 100
IVECO - SCANIA
BOSCH F.00V.X99.995
IVECO 500379769
SCANIA 1440576**cm2171-009****KIT DE O'RINGS, EXTERNO**
PDE 90
IVECO
BOSCH F.00V.X99.996
IVECO 500350189**cm2171-010****KIT DE O'RINGS**
PDE90-100
BOSCH F.00H.N37.928
SCANIA 1731209
WITHOUT MAGNET AND NUT:
BOSCH F.00H.N37.925
SCANIA 1728288

SISTEMA PDE
BOSCH**cm2171-011****KIT DE O'RINGS**
PDE 80
VOLKSWAGEN**cm2171-012****KIT DE O'RINGS PARA SOLENOIDES**
PDE90
SCANIA**cm2171-013****KIT DE O'RINGS PARA SOLENOIDES**
PDE90
EUI - BOSCH**cm2171-014****KIT DE O'RINGS PARA SOLENOIDE**
PDE 80
VOLKSWAGEN**cm2171-015****KIT DE 6 O'RINGS PARA INYECTORES**
CUMMINS

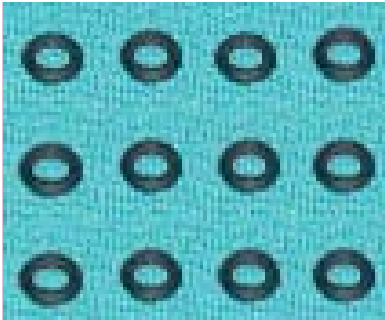
SISTEMA PDE
BOSCH**cm2171-016****KIT DE 12 O'RINGS PARA INYECTORES**

IVECO

Bosch: 243 021 00 82

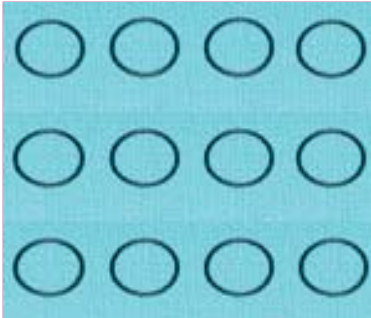
**cm2171-017****KIT DE 12 O'RINGS PARA SOLENOIDES DE INYECTORES BOSCH CRI**

COMMON RAIL

CUMMINS

**cm2171-018****KIT DE O'RINGS PARA INYECTOR + SOLENOIDE**

CURSOR 8

SCANIA, VOLVO, IVECO

**cm2171-019****KIT DE O'RINGS Y PERNOS**

PDE 100

BOSCH F.00H.N37.927

**cm2171-020****KIT PARA SCANIA**

SCANIA

PDE90-100

BOSCH F.00H.N37.912

SCANIA 1541175

SISTEMA PDE
BOSCH**cm2171-021****JUEGO DE JUNTAS**

PDE 75-80

BOSCH 1.417.010.997

VOLKSWAGEN EUROVAN 038.198.051B

**cm2171-022****KIT DE PERNOS PARA ALINEACIÓN**

PDE 80

Ø 1,5x17mm.

CONTIENE 10 PIEZAS

**cm2171-023****KIT DE PERNOS PARA ALINEACIÓN**

PDE 80

Ø 1,8x17mm.

CONTIENE 10 PIEZAS

**cm2171-024****KIT DE PERNOS PARA ALINEACIÓN**

PDE 80

Ø 1,5x24mm.

CONTIENE 10 PIEZAS

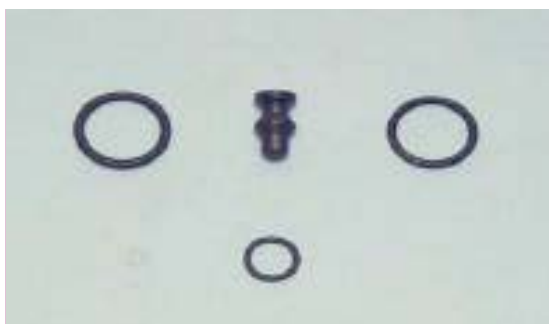
**cm2171-025****KIT PARA VOLKSWAGEN**

PDE 80

CÓDIGO BOSCH: 1.417.010.996

CÓDIGO VW: 03G198051

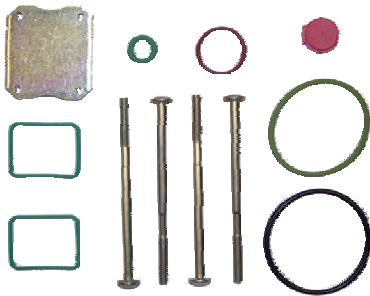
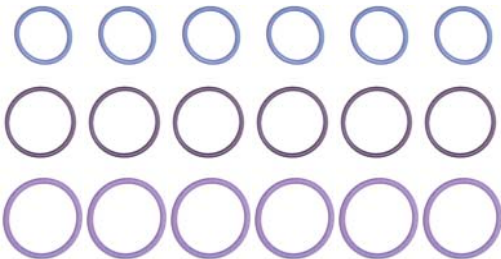
**SISTEMA PDE
BOSCH****cm2171-026****KIT PARA MERCEDES ATEGO****PDE 110 - 110****CÓDIGO BOSCH F.00H.N37.070****CÓDIGO MERCEDES 012074.0101****cm2171-027****KIT DE REPARACIÓN M.BENZ****PLD - ATEGO - AXOR - ATEGO****MOTOR OM 904/906****CÓDIGO BOSCH F.00H.N37.069****JR 155/311AG****KIT DE O'RINGS****PARA INYECTOR BOMBA SISTEMA PDE****SCANIA SERIE 4****CÓDIGO BOSCH F 00V X99 999****CÓDIGO SCANIA: 1422564****CÓDIGO SCANIA: 1398810**

SISTEMA PDE
BOSCH

PISTONES DE VALVULAS PARA BOMBA PDE BOSCH	
CODIGO	MEDIDA
cm2172-6995	6,995
cm2172-7000	7,000
cm2172-7005	7,005
cm2172-7010	7,010
cm2172-7015	7,015

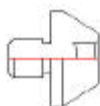

SISTEMA PDE
BOSCH**cm2199-001****PLAQUETA**
Ø 18x5, CON PERNO
BOSCH**cm2199-002****PLAQUETA**
Ø 18x5, CON PERNO
PARA VOLVO**cm2199-003****PERNO DE PRESIÓN**
BOSCH**cm2199-004****PERNO DE PRESIÓN**
PARA VOLVO**cm2199-005****PERNO**
PARA VOLKSWAGEN
PDE 80
BOSCH 1.413.127.045
BOSCH 1.413.127.082
VW 038130335A



DESPIECES VARIOS

ASSEMBLY PARTS

2199

02

SISTEMA PDE
BOSCH

+F00HN37925

**JUEGO DE PIEZAS
PARA SOLENOIDE
CÓDIGO BOSCH: F 00H N37 925**



KIT DE REPARACIÓN DE INYECTORES BOMBA / PDE

INJECTOR PUMPS / PDE REPAIR KIT

2271

01

SISTEMA PDE
DELPHI



cm2271-001

KIT DE O'RINGS PARA INYECTOR + SOLENOIDE

CURSOR 8 - 10 - 13
SCANIA, VOLVO
DELPHI



MONOBOMBAS (UPS/PLD)

3120

01



cm3120-005

MONOBOMBA (UPS/PLD) MERCEDES BENZ OM457

AXOR 1835-2035 OM457
ACTROS 1831-1832-2035 OM541
CÓDIGO BOSCH: 0414799005
0986445002
0986445102
MERCEDES BENZ: A0280745902



PORTATOBERAS

NOZZLE NUT CAPS

3123

01

SISTEMA PLD
BOSCH



PT 170/71

PORTATOBERA

MERCEDES BENZ OM 904/712/1115 ELECTRONIC
156P1411
CÓDIGO: 2 433 249 189

SISTEMA PLD
BOSCH

AG 122/603



O'RING PARA INYECTOR
DE VITÓN
CÓDIGO: 2 430 210 081

SISTEMA PLD
BOSCH

AC 112/50**ARANDELA DE COBRE****MERCEDES BENZ OM 904 - OM 906 ELECTRONIC****CÓDIGO BOSCH: 2 430 105 049****CÓDIGO M. BENZ: 906 017 02 60****AC 112/54****ARANDELA BUJE****MERCEDES BENZ OM 904 - OM 906****CÓDIGO M. BENZ: 906 017 08 60****AC 112/54A****ARANDELA DE COBRE****ASIENTO INYECTOR****NAVISTAR ELECTRONICO**

SISTEMA PLD
BOSCH**cm3181-001****JUEGO DE PIEZAS MERCEDES BENZ ACTROS
MONOBOMBA****cm3181-002****JUEGO DE PIEZAS PLD RENAULT****cm3181-003****JUEGO DE PIEZAS MERCEDES BENZ ATEGO
MONOBOMBA****cm3181-004****TORNILLOS
MERCEDES****cm3181-005****TORNILLOS M4x0,7
MERCEDES BENZ Atego - OM904**

SISTEMA PLD
BOSCH

JR 155/312AG



KIT DE O'RINGS

PARA BOMBA UNITARIA (MONOBOMBA) BOSCH
SISTEMA PLD PARA MB OM 904 / OM906 ELECTRÓNICO
CÓDIGO BOSCH: F 00H N37 454
CÓDIGO MB: A0289975648

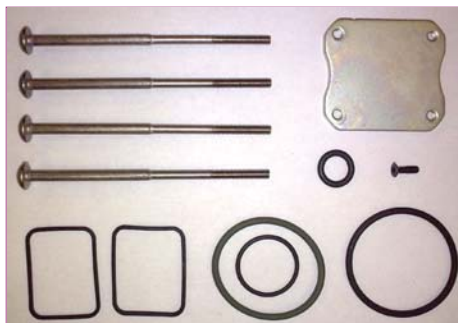

+F00HN37070

JUEGO DE JUNTAS

PLD
CÓDIGO BOSCH: F00HN37070

SISTEMA PLD
BOSCH

PISTONES DE VALVULAS	
PARA MONOBOMBA PLD BOSCH	
CODIGO	MEDIDA
cm3182-6995	6,995
cm3182-7000	7,000
cm3182-7005	7,005
cm3182-7010	7,010
cm3182-7015	7,015



SISTEMA PLD
BOSCH

**+F00HN36628**

IMPULSOR DE RODILLO
BOMBA PLD
CÓDIGO BOSCH: F 00H N36 628

+F00HN36635

RESORTE
BOMBA PLD
CÓDIGO BOSCH: F 00H N36 635

+F00HN37431

SOLENOIDE
BOMBA PLD
CÓDIGO BOSCH: F 00H N37 431

**.SV 190/32**

**SEGURO DE SUJECION
PARA INYECTORES**
SIEMENS

COMMON RAIL
SIEMENS

**cm3199-002**

CANULA DE INYECTOR
MERCEDES BENZ OM 904 (PLB)

Codigo Bosch: 2433370467
Codigo Mercedes Benz: A5410170324
A9060170521
A9060170524
A9060170324



PORTATOBERAS

NOOZLE CAP NUTS

4123

01

BOMBAS EDC
BOSCH

PT 170/66



PORTATOBERA

PARA INYECTOR 0 432 191 488/493/503/523
OM 447 - OM 449 - MERCEDES BENZ 1938 "EDC" 160P577
CÓDIGO BOSCH: 2 433 349 503



DESPIECES VARIOS

ASSEMBLY PARTS

4199

01

BOMBAS EDC
BOSCH

cm4199-001



JUNTA CON FORMA EDC

CÓDIGO: 94 105 07

cm4199-003



JUEGO DE JUNTAS BOMBAS VE CON REGULADOR ELECTRÓNICO EDC

CÓDIGO: 2 467 010 003

cm4199-004



Bosch
1467045046

Juego de juntas Bosch con EDC - VP44
RENAULT - FIAT - VOLKSWAGEN
CHEVROLET - FORD

cm4199-005



Bosch
F00N350001

Juego de juntas Bosch con EDC - VP29 - VP30
RENAULT - FIAT - VOLKSWAGEN
CHEVROLET - FORD



cm4299-001

ELECTROVALVULA DE AVANCE 12V TIPO CAV DPCN

FIAT - IVECO
LUCAS / DELPHI: 9108-154B
RENAULT: 7701044974



cm4299-002

ELECTROVALVULA DE AVANCE 12V TIPO CAV DPCN

PEUGEOT
LUCAS / DELPHI: 9108-152A



cm4299-003

ELECTROVALVULA DE AVANCE 12V TIPO CAV DPCN

RENAULT
LUCAS / DELPHI: 9108-147A
RENAULT: 7701045695



cm4299-004

ELECTROVALVULA DE AVANCE 12V TIPO CAV DPCN

FORD
LUCAS / DELPHI: 9108-153A



cm4299-005

ELECTROVALVULA DE AVANCE 12V ACTUADOR

FORD MONDEO / ESCORT / ORION
LUCAS / DELPHI: 9100-898B



cm4299-006

ELECTROVALVULA DE AVANCE 12V ACTUADOR

**VOLSKWAGEN SKODA - SKODA TDI
LUCAS / DELPHI: 9100-827F**

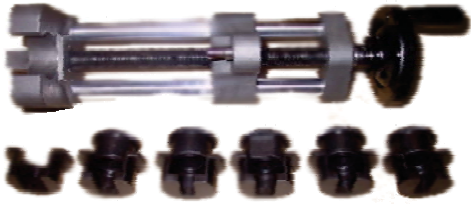
**HERRAMIENTAS
UNIVERSAL****cm6000-001****HERRAMIENTA PARA DESMANTELAMIENTO
INYECTORES COMMON RAIL DOBLE MUELLE****cm6000-002****LLAVE TUBO
PARA SOLENOIDE UIS****cm6000-003****RACORD PARA INYECTOR
DELPHI - VOLVO 420 - 460****cm6000-004****RACORD PARA INYECTOR
SCANIA / VOLVO / IVECO - PDE31 - PDE100****cm6000-005****RACORD PARA INYECTOR
PDE80 VOLKSWAGEN****cm6000-006****RACORD PARA INYECTOR
PDE80 - VOLKSWAGEN 80.2 (NEW)**

HERRAMIENTAS
UNIVERSAL



cm6000-006

**RACORD PARA INYECTOR
PDE80 - VOLKSWAGEN 80.2 (NEW)**

HERRAMIENTAS
UNIVERSAL



cm6090-001

CAJA DE REPARACIÓN BOMBA COMMON RAIL Cp1



cm6090-002

CAJA DE REPARACIÓN BOMBA COMMON RAIL Cp3

HERRAMIENTAS
UNIVERSAL



cm6090-001

CAJA DE REPARACIÓN BOMBA COMMON RAIL Cp1



cm6090-002

CAJA DE REPARACIÓN BOMBA COMMON RAIL Cp3



cm6090-003

ALZA BOTADOR BOMBA CP3 (JUEGO DE 3 UNIDADES)



cm6090-004

BRIDA PARA BOMBA COMMON RAIL TECTOR

**HERRAMIENTAS
UNIVERSAL****cm6090-003****ALZA BOTADOR BOMBA CP3 (JUEGO DE 3 UNIDADES)****cm6090-004****BRIDA PARA BOMBA COMMON RAIL TECTOR****HERRAMIENTAS
UNIVERSAL****cm6091-001****TUBO PARA INYECTOR PDE AUDI/VW 80.2 NUEVO**

**HERRAMIENTAS
UNIVERSAL****cm6091-001****TUBO PARA INYECTOR PDE AUDI/VW 80.2 NUEVO****cm6091-002****TUBO PARA INYECTOR PDE AUDI/VW 80.2 NUEVO****cm6091-003****LLAVE MONTAJE INYECTOR COMMON RAIL TECTOR 12 LADOS****cm6091-004****LLAVE APERTURA INYECTOR COMMON RAIL
15-17-19-27-29-30****cm6091-005****TUBO MONTAJE INYECTOR COMMON RAIL BOSCH 29mm.****cm6091-006****TUBO MONTAJE INYECTOR COMMON RAIL BOSCH 30mm.**

HERRAMIENTAS
UNIVERSAL**cm6091-002****TUBO PARA INYECTOR PDE AUDI/VW 80.2 NUEVO****cm6091-003****LLAVE MONTAJE INYECTOR COMMON RAIL TECTOR 12 LADOS****cm6091-004****LLAVE APERTURA INYECTOR COMMON RAIL
15-17-19-27-29-30****cm6091-005****TUBO MONTAJE INYECTOR COMMON RAIL BOSCH 29mm.****cm6091-006****TUBO MONTAJE INYECTOR COMMON RAIL BOSCH 30mm.**



HERRAMIENTAS PARA ARME Y DESARME DE INYECTORES

INJECTORS ASSEMBLE AND DISASSEMBLE TOOLS

6091

02

HERRAMIENTAS
UNIVERSAL



cm6091-006

TUBO MONTAJE INYECTOR COMMON RAIL BOSCH 30mm.



HERRAMIENTAS PARA REPARACIÓN DE INYECTORES

INJECTORS REPAIR TOOLS

6092

01

HERRAMIENTAS
UNIVERSAL



cm6092-001

KIT CONTROL DE RETORNO COMMON RAIL BOSCH



cm6092-001

KIT CONTROL DE RETORNO COMMON RAIL BOSCH



cm6092-002

KIT CONTROL DE RETORNO COMMON RAIL COMPLETO



cm6092-003

**KIT EXTRACTOR ANILLO DE FIBRA PARA INYECTOR
COMMON RAIL**



cm6092-004

**CONTROL DE ESTANQUIDAD PERNO PRESIÓN
INYECTOR BOSCH COMMON RAIL**



cm6092-005

**KIT PARA ESMERILAR ASIENTO BOLITA
INYECTOR COMMON RAIL BOSCH**



cm6092-006

**CONTROL DEL ASIENTO DE LA ESFERA
EN EL INYECTOR BOSCH COMMON RAIL**

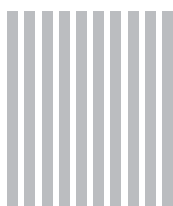
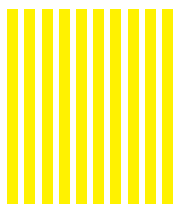
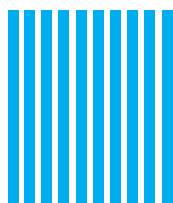
HERRAMIENTAS
UNIVERSAL**cm6092-007****RETIFICADORA DE LA SEDE DE LA ESFERA
DE LOS INYECTORES CR BOSCH 220V****cm6092-007A****TELA ABRASIVA PARA RECTIFICAR ASIENTO DE ESFERA
GRIS e=15 μ x 10 UNIDADES****cm6092-007B****TELA ABRASIVA PARA RECTIFICAR ASIENTO DE ESFERA
AMARILLO e=12 μ x 10 UNIDADES****cm6092-007C****TELA ABRASIVA PARA RECTIFICAR ASIENTO DE ESFERA
AZUL e=9 μ x 10 UNIDADES****cm6092-007D****TELA ABRASIVA PARA RECTIFICAR ASIENTO DE ESFERA
MARRON e=5 μ x 10 UNIDADES**

HERRAMIENTAS
UNIVERSAL

cm6092-008



**VACUOMETRO PARA PRUEBA DE ESTANQUEIDAD
DE VÁLVULA DE 3RA ETAPA**

cm6092-009



MEDIDOR DE PRESIÓN DE RIEL COMMON RAIL

cm6092-010



DISPOSITIVO PARA DESARME DE INYECTORES COMMON RAIL

cm6099-001



COMPRESOMETRO MEDIDOR DE COMPRESIÓN CON ADAPTADORES

cm6099-002



MICRÓMETRO DIGITAL MILESIMAL

HERRAMIENTAS
BOSCH

cm6190-001



**HERRAMIENTA PARA RECTIFICAR EL
ASIENTO DE VÁLVULA DE MONOBOMBAS PDE**

cm6190-002



**HERRAMIENTA PARA PULIR EL ASIENTO DE VÁLVULA
DE MONOBOMBAS PDE**

cm6390-001



Soporte para bomba sin desarmar engranajes de distribución

FORD RANGER 2.2 / 3.2 MOTOR PUMA

COMMON RAIL

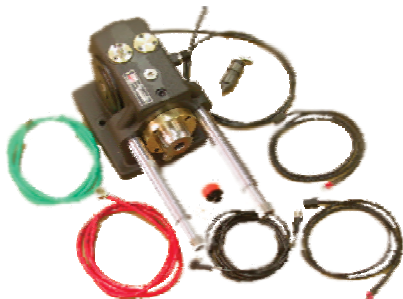
MAQUINARIAS
UNIVERSAL**cm7000-004****SIMULADOR PARA EL SISTEMA COMMON RAIL**
PARA TESTEO DE SISTEMA UIS / PLD
Y SISTEMA CARRITO cm7000-004a**cm7000-004A****CARRO PARA SIMULADOR CON PC , IMPRESORA Y
SOFTWARE WINDOWS PRECARGADO**CREADO PARA EL SIMULADOR cm7000-004
CONTIENE IMPRESORA Y PC INDUSTRIAL
TAMBIEN ESTA DISPONIBLE CON PANTALLA TACTIL**cm7000-005****SIMULADOR**
PARA SISTEMAS UIS - PLD - EUS - EMD
CON PUERTO SERIAL**cm7000-006****KIT PARA SISTEMA BOSCH**
FORMATO DE KIT PARA BOMBA CP1 - CP3
E INYECTORES CR - NECESARIO PARA TESTO DE SISTEMA BOSCH
FUNCIONA CON cm7000-004**cm7000-007****KIT CAM BOX**
PARA TESTEO DE SISTEMA UIS / PLD
COMPLETO CON TODOS LOS ACCESORIOS NECESARIOS
DISPOSITIVO AUTÓNOMO

**MAQUINARIAS
UNIVERSAL****cm7000-008****KIT SISTEMA DELPHI**
PARA BOMBAS E INYECTORES CR
FUNCIONA CON cm7000-004
DISPOSITIVO AUTÓNOMO**cm7000-009****KIT SISTEMA SIEMENS**
PARA BOMBAS E INYECTORES CR
FUNCIONA CON cm7000-004
DISPOSITIVO AUTÓNOMO**cm7000-010****KIT SISTEMA DENSO**
PARA BOMBAS E INYECTORES CR
FUNCIONA CON cm7000-004
DISPOSITIVO AUTÓNOMO**cm7000-011****KIT PARA SISTEMA BOSCH MERCEDES BENZ**
BOMBA CP1 E INYECTORES
FUNCIONA CON SIMULADOR cm7000-004**cm7000-012****AMPLIFICADOR PIEZO**
CON SOFTWARE DE GESTIÓN DE DETECCIÓN

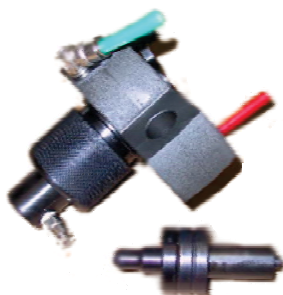
MAQUINARIAS
UNIVERSAL**cm7000-013****ADAPTADOR PIEZO D7**
PARA 4 CANALES - PARA COMMON RAIL
FUNCIONA CON SIMULADOR cm7000-004
ACCESORIO PARA EL cm7000-012**cm7000-014****ADAPTADOR PIEZO**
PARA CAM BOX - PARA EL cm7000-012
FUNCIONA CON SIMULADOR cm7000-004**cm7000-015****KIT SISTEMA UIS / PLD**
FUNCIONA CON SIMULADOR cm7000-004
NECESARIO SÓLO SI VA A TESTEAR ESTE SISTEMA
CON EL SISTEMA DEL cm7000-004**cm7000-016****KIT PARA BOMBA**
FUNCIONA CON SIMULADOR cm7000-004**cm7000-020****ADAPTADOR EUI PARA INYECTOR**
VOLKSWAGEN - AUDI
FUNCIONA CON CAM BOX cm7000-007

MAQUINARIAS
UNIVERSAL

cm7000-021

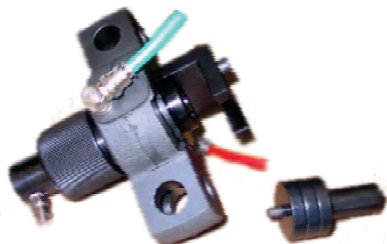

**ADAPTADOR EUI PARA INYECTOR DELPHI
BEBE2A00001 LAND ROVER DISCOVERY**
FUNCIONA CON CAM BOX cm7000-007

cm7000-022

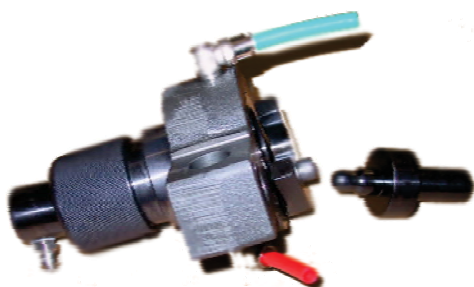

**ADAPTADOR EUI PARA INYECTOR
IVECO CURSOR 430-PDE100**
FUNCIONA CON CAM BOX cm7000-007

cm7000-023

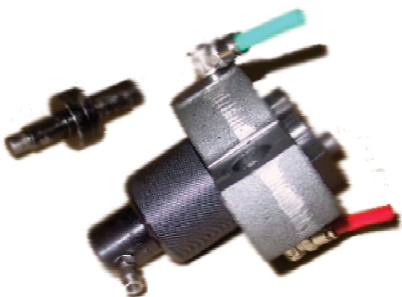

**ADAPTADOR EUI PARA INYECTOR
CATERPILLAR 3406-C15-L15**
FUNCIONA CON CAM BOX cm7000-007

cm7000-024

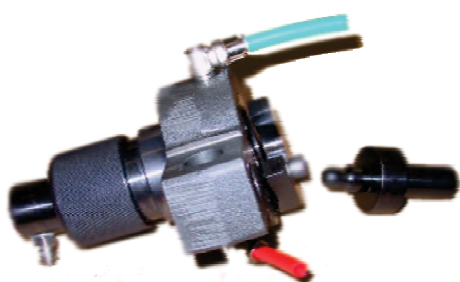

**ADAPTADOR EUI PARA INYECTOR
VOLVO 420-460 - DELPHI**
FUNCIONA CON CAM BOX cm7000-007

cm7000-025

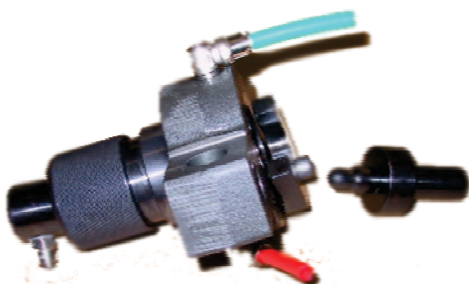

**ADAPTADOR EUI PARA INYECTOR
IVECO CURSOR 350**
FUNCIONA CON CAM BOX cm7000-007

MAQUINARIAS
UNIVERSAL

cm7000-026

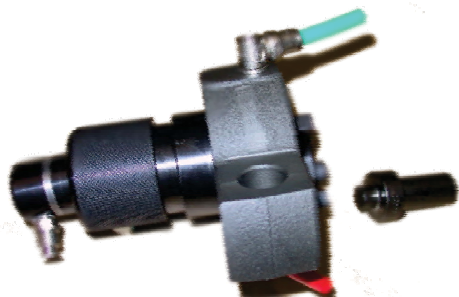

**ADAPTADOR EUI PARA INYECTOR
CATERPILLAR 3406E-3176-3196-C12-C10**
FUNCIONA CON CAM BOX cm7000-007

cm7000-027

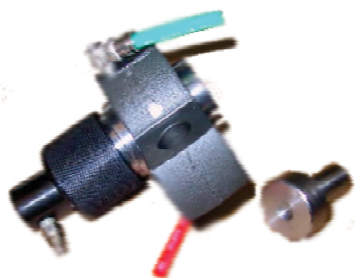

**ADAPTADOR EUI PARA INYECTOR
CUMMINS CELECT - L10 - M11 - N14**
FUNCIONA CON CAM BOX cm7000-007

cm7000-028

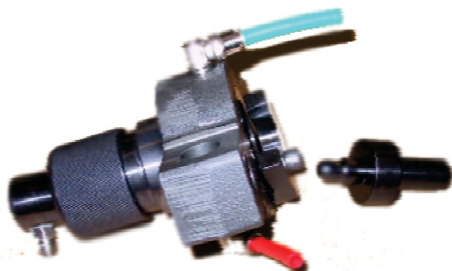

**ADAPTADOR EUI PARA INYECTOR
DETROIT DIESEL 50-60**
FUNCIONA CON CAM BOX cm7000-007

cm7000-029

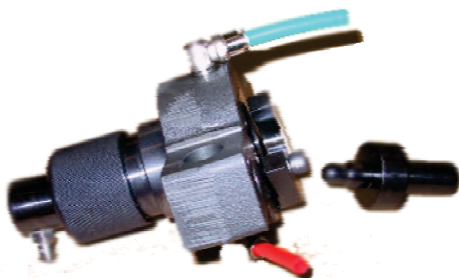

**ADAPTADOR EUI PARA INYECTOR
DETROIT DIESEL 5234770-5235575**
FUNCIONA CON CAM BOX cm7000-007

cm7000-030

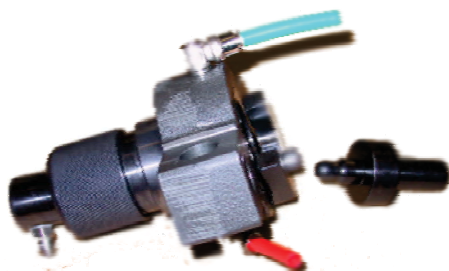

**ADAPTADOR EUI PARA INYECTOR
DELPHI JOHN DEERE 64866**
FUNCIONA CON CAM BOX cm7000-007

MAQUINARIAS
UNIVERSAL

cm7000-031

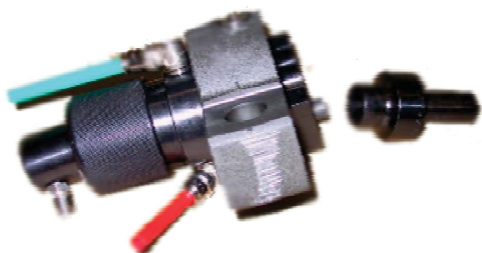

**ADAPTADOR EUI PARA INYECTOR
SCANIA PDE100S 2006**
FUNCIONA CON CAM BOX cm7000-007

cm7000-032

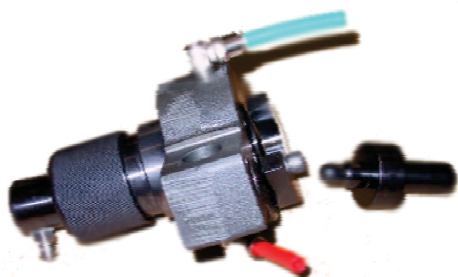

**ADAPTADOR EUI PARA INYECTOR
VOLVO 420-460 - BOSCH**
FUNCIONA CON CAM BOX cm7000-007

cm7000-033

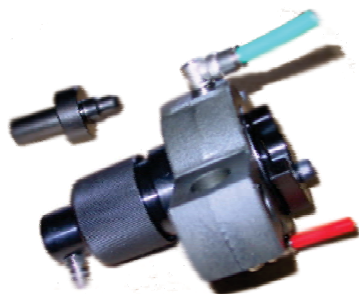

**ADAPTADOR EUI PARA INYECTOR
VOLVO 500 HP- DELPHI E1-E2**
FUNCIONA CON CAM BOX cm7000-007

cm7000-034

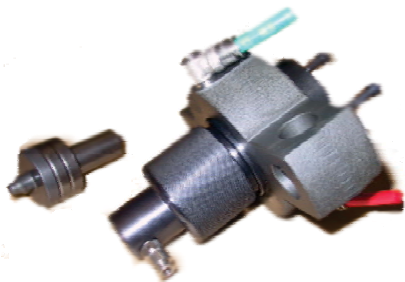

**ADAPTADOR EUI PARA INYECTOR
AUDI - VOLKSWAGEN PDE 80.2**
FUNCIONA CON CAM BOX cm7000-007

cm7000-035

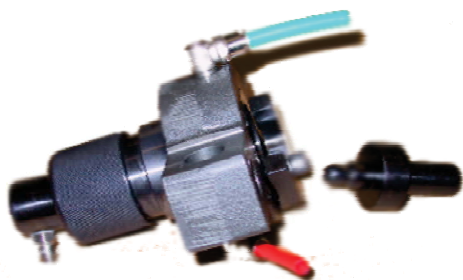

**ADAPTADOR EUI PARA INYECTOR
CATERPILLAR EMD**
FUNCIONA CON CAM BOX cm7000-007

MAQUINARIAS
UNIVERSAL

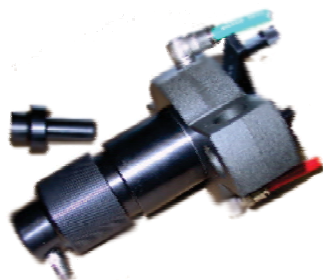

cm7000-036

**ADAPTADOR EUI PARA INYECTOR
CATERPILLAR MECHANIC SERIES 3500 - 4P9076**
FUNCIONA CON CAM BOX cm7000-007

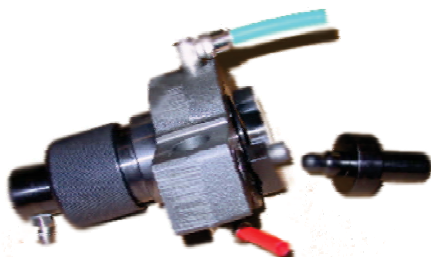

cm7000-037

**ADAPTADOR EUI PARA INYECTOR
CATERPILLAR ELECTRONIC SERIES 3500-7E8836**
FUNCIONA CON CAM BOX cm7000-007

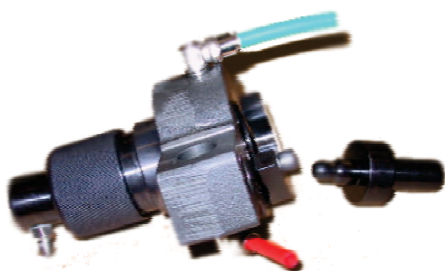

cm7000-038

**ADAPTADOR EUI PARA INYECTOR
DETROIT DIESEL 5234366**
FUNCIONA CON CAM BOX cm7000-007

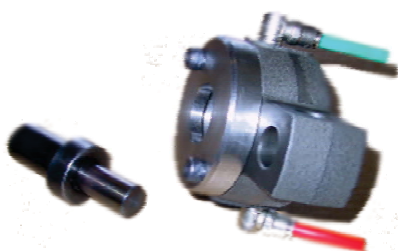

cm7000-039

**ADAPTADOR EUI PARA INYECTOR
DEUTZ-CULLIMAN-SAME 101**
FUNCIONA CON CAM BOX cm7000-007

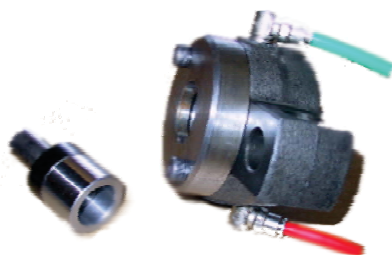

cm7000-040

**ADAPTADOR EUI PARA INYECTOR
DEUTZ-CULLIMAN-SAME 102**
FUNCIONA CON CAM BOX cm7000-007

MAQUINARIAS
UNIVERSAL

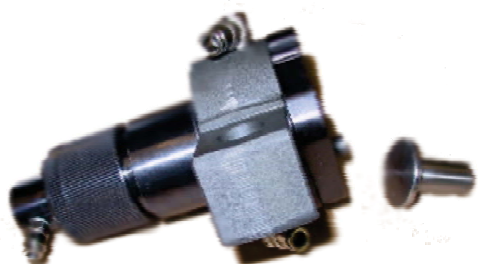

cm7000-041

**ADAPTADOR EUI PARA INYECTOR
DELPHI KCC0T120A0020 FOR PERKINS**
FUNCIONA CON CAM BOX cm7000-007

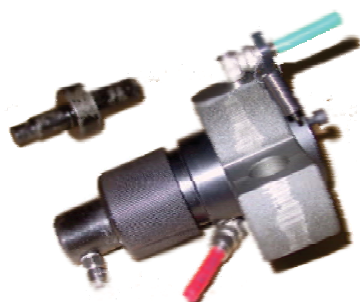

cm7000-042

**ADAPTADOR EUI PARA INYECTOR
CATERPILLAR MECANICO 1.1**
FUNCIONA CON CAM BOX cm7000-007

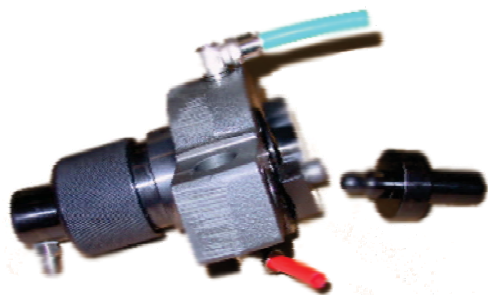

cm7000-043

**ADAPTADOR EUI PARA INYECTOR
NISSAN 440**
FUNCIONA CON CAM BOX cm7000-007

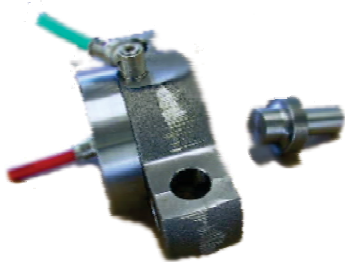

cm7000-044

**ADAPTADOR EUI PARA INYECTOR
PLD110 MERCEDES ATEGO**
FUNCIONA CON CAM BOX cm7000-007

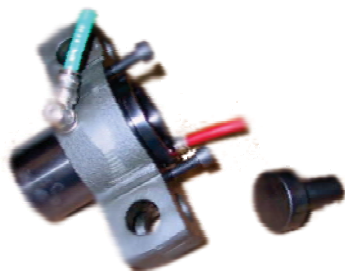

cm7000-045

**ADAPTADOR EUI PARA INYECTOR
PLD100 MERCEDES ACTROS**
FUNCIONA CON CAM BOX cm7000-007

MAQUINARIAS
UNIVERSAL

cm7000-046



**ADAPTADOR EUI PARA INYECTOR
PLD100-110 TIPO B MACK-RENAULT-DAF-KHD**
FUNCIONA CON CAM BOX cm7000-007

cm7000-047



FLUJOMETRO A DOS CANALES
INCLUYE TODOS LOS CABLES NECESARIOS

cm7000-048

KIT SENSOR DE GOLPE Y RMP PARA FLUJOMETRO
ACCESORIO PARA EL cm7000-047

cm7000-049

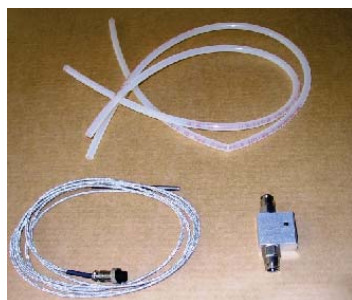

**KIT CONTROL DE TEMPERATURA DE INGRESO
Y SALIDA PARA FLUJOMETRO**