

ILLINOIS®

CATÁLOGO DE PRODUCTOS
CATÁLOGO DE PRODUTOS
PRODUCT CATALOG
Nº 11

LÍNEAS LIVIANA Y UTILITARIOS
LINHAS LEVE E UTILITÁRIOS
CARS AND COMMERCIAL VEHICLES



▶ AGRALE

▶ ALFA ROMEO

▶ ASIA

▶ AUDI

▶ BORGWARD

▶ CHANGAN

▶ CHERY

▶ CHEVROLET / OPEL

▶ CHRYSLER

▶ CITROEN

▶ DAIHATSU

▶ DAEWOO

▶ DI TELLA

▶ DODGE

▶ ESTANCIERA / IKA

▶ FIAT

▶ FORD

▶ HAFEI

▶ HONDA

▶ HYUNDAI

▶ ISUZU

▶ IVECO

▶ JEEP

▶ KIA

▶ LADA

▶ LANCIA

▶ MERCEDES BENZ

▶ MASSEY FERGUSON

▶ M.W.M.

▶ MAXION

▶ MAZDA

▶ MITSUBISHI

▶ NISSAN

▶ OPEL

▶ PERKINS

▶ PEUGEOT

▶ RASTROJERO

▶ RENAULT

▶ ROVER

▶ SEAT

▶ SKODA

▶ SSANG YONG

▶ SUZUKI

▶ TORINO

▶ TOYOTA

▶ VALIANT

▶ VALTRA VALMET

▶ VOLARE

▶ VOLKSWAGEN

▶ VOLVO

▶ **JUEGO COMPLETO DE REPARACION / Jogo de juntas do motor / Full set gaskets**

▶ **SEMI-JUEGO DE REPARACIÓN (Sin TC) / Semi jogo (Sem Cabeçote) / Full set gasket (Without c. head)**

▶ **JUEGO DE DESCARBONIZACIÓN / Jogo de juntas superior / Head set gasket**

▶ **JUNTA CULATA DE CILINDRO (fuera de juegos completos de reparación) / JUNTA DE CABEÇOTE (não incluídos nos jogo do motor) / CYLINDER HEAD GASKET (models not included in full set gasket)**

▶ **JUEGO JUNTAS PARA CAJA DE VELOCIDAD / Jogo juntas para caixa de câmbio / Gear box set gaskets**

▶ **JUEGO DE JUNTAS PARA TURBO COMPRESOR / Jogo de juntas para turbo compressor / turbo compressor set gaskets**

▶ **JUEGO JUNTAS PARA CARBURADOR / Jogo juntas para carburador / Carburetor set gaskets**

▶ **JUNTAS PARA DIFERENCIAL Y PALIER / Juntas para diferencial e ponta de eixo / Differential and bearing set gaskets**

▶ **SELLADORES Y FORMADORES DE JUNTA LÍQUIDA / Seladores e formadores de junta líquida / Sealants and shapers for gasket**

▶ **TORNILLOS PARA TAPA DE CILINDROS / Parafusos de cabeçote / Screws for cylinder heads**

JUNTAS ILLINOIS, UN COMPROMISO CONSTANTE CON LA EXCELENCIA.
JUNTAS ILLINOIS UM COMPROMISSO CONSTANTE COM A EXCELÊNCIA.
JUNTAS ILLINOIS A CONSTANT COMMITMENT WITH EXCELLENCE.

ESP **Juntas Illinois S.A.** pertenece al rubro metalmecánica, su actividad principal es la fabricación y comercialización de juntas y repuestos automotrices para todo tipo de motores.

La empresa fue fundada en Rosario, Argentina en el año 1943 bajo el nombre de Martínez y Tur, en referencia a sus fundadores. Años más tarde el Sr. Ricardo Tur, uno de los socios, adquirió la totalidad de la firma y a partir de allí, la denominación de la empresa cambió a Juntas Illinois S.A.

Actualmente el **Sr. Daniel Tur** es el Presidente de la firma, y comparte la conducción de la misma con un equipo de colaboradores profesionales que incluye a la tercera generación familiar, que se ha capacitado y especializado en las distintas áreas del negocio. En conjunto, siguen escribiendo la historia de Juntas Illinois sobre sólidas bases de un pasado vigoroso, un presente en plena expansión, y la proyección de un futuro promisorio lleno de desafíos.



- 2018 - 75 ANIVERSARIO JUNTAS ILLINOIS ▪
- 2018 - 75 ANIVERSÁRIO JUNTAS ILLINOIS ▪
- 2018 - 75 ANNIVERSARY JUNTAS ILLINOIS ▪



PORT A empresa **Juntas Illinois S.A.** faz parte do setor metal-mecânica. Sua atividade principal é a fabricação e comercialização de juntas e peças automotivas de reposição para todo tipo de motores.

A empresa foi fundada em Rosário, Argentina em 1943 com o nome de Martínez y Tur, fazendo referência a seus fundadores. Anos mais tarde o Sr. Ricardo Tur, um dos sócios, adquiriu a totalidade da empresa e a partir daí, a razão social da empresa mudou para Juntas Illinois S.A.

Atualmente o **Sr. Daniel Tur** é o Presidente da firma e compartilha a condução da mesma com uma equipe de colaboradores profissionais que inclui a terceira geração familiar. Em conjunto continuam escrevendo a história de Juntas Illinois sobre sólidas bases de um passado vigoroso, um presente em plena expansão e a projeção de um futuro promissor com muitos desafios.

ENG Belonging to the metalmechanic group, the main activity of **Juntas Illinois S.A.** is the manufacture and commercialization of gaskets and automotive spare parts for all types of motors.

The company was founded in Rosario, Argentina, in the year 1943, under the name of Martínez & Tur. Some years later, Ricardo Tur, one of the partners, acquired the totality of the firm and changed the name to Juntas Illinois S.A.

Currently **Mr Daniel Tur** is the chairman of the firm and shares management with a team of trained professional collaborators specialists in different areas of the business, some of whom are third generation of the family. Together they keep writing the story of Juntas Illinois upon solid grounds of a vigorous past, a present full of expansion and a promising future full of challenges.





ESTRUCTURA

Juntas Illinois S.A. cuenta con una planta industrial modelo, de referencia internacional, emplazada sobre un predio de 7000 m2.

El concepto de esta nueva nave es un claro ejemplo de cómo la higiene, la seguridad y el orden, en el marco de un ambiente de trabajo agradable, aumentan la productividad y mejoran el flujo de todos los procesos productivos.

En los últimos años la empresa ha realizado importantes inversiones para asegurar el crecimiento y continuar con la modernización de su infraestructura, desarrollando una Cadena de Valor dinámica, que garantiza la eficiencia y calidad de todos los procesos.



DIRECTORIO JUNTAS ILLINOIS S.A.

ESTRUTURA

A **Juntas Illinois S.A.** conta com uma planta industrial, modelo de nível internacional, construída em uma área de 7000 m2.

O conceito destas instalações é um claro exemplo de como a higiene, a segurança e a ordem dentro de um ambiente de trabalho agradável aumentam a produtividade e melhora o fluxo de todos os processos produtivos.

Nos últimos anos a empresa realizou importantes investimentos para garantir o crescimento e continuar com a modernização de sua infra-estrutura, desenvolvendo uma Cadeia de Valor dinâmica que garante a eficiência e a qualidade de todos os processos.

STRUCTURE

A model industrial plant of international standing, **Juntas Illinois S.A.** is located on a site of 7000 m2.

The concept of this new shed is a clear example of how hygiene, security and order in the framework of a pleasant working environment increases the productivity and improves the flow of all the productive processes.

In order to assure the growth and continuing modernization of its infrastructure, in the last few years the company has made significant investments. We have developed a dynamic Value Chain that guarantees efficiency and quality of all processes.

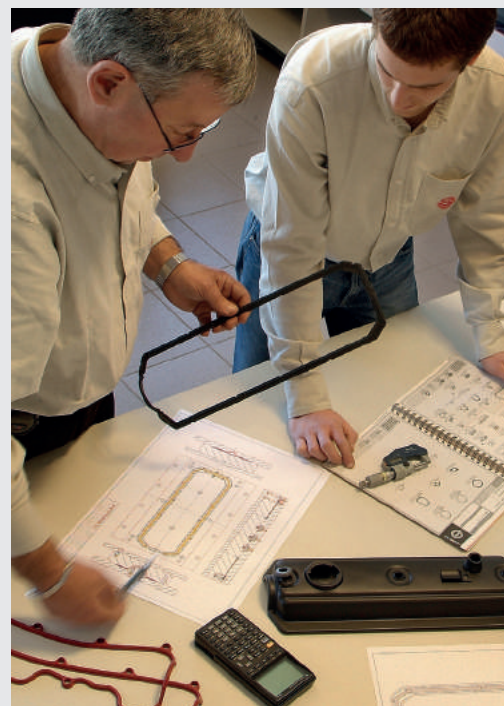

SISTEMA DE GESTION CERTIFICADO ISO 9001
CERTIFICADO DE SISTEMA DE GESTÃO ISO 9001
SYSTEM OF MANAGEMENT CERTIFIED ISO 9001

DESDE 1943, ATENDIENDO AL MERCADO AUTOMOTOR.
DESDE 1943, ATENDENDO O MERCADO AUTOMOTIVO.
DEALING WITH THE AUTOMOTIVE MARKET SINCE 1943.

ESP Juntas Illinois presenta una amplia gama de productos para el sellado del motor. Los productos se fabrican bajo las más estrictas normas internacionales de calidad, utilizando materias primas de origen europeo y norteamericano.

Actualmente, el catálogo de productos cuenta con una oferta de más de **11.600 referencias** y continúa en proceso de ampliación. Para alcanzar estos volúmenes, la empresa ha ido incorporando nuevas tecnologías, capacitando a su personal y ha implementado una importante política de desarrollo a proveedores, de manera tal que toda la Cadena de Valor se encuentre bajo un mismo lineamiento.



PORT A Juntas Illinois apresenta uma ampla gama de produtos para a selagem do motor.

Os produtos são fabricados sob as mais rigorosas normas internacionais de qualidade, utilizando matérias primas de origem europeia e norte-americana.

Atualmente, o catálogo de produtos conta com uma oferta de mais de **11.600 itens** e continua em processo de ampliação. Para alcançar estes volumes, a empresa foi incorporando novas tecnologias e capacitando seus funcionários. Além disso, implementou uma importante política de desenvolvimento com os fornecedores, de maneira onde toda a Cadeia de Valor se encontra sob um mesmo lineamento.

ENG A wide range of products for sealing motors is presented by Juntas Illinois.

The products are manufactured under strict international quality norms using raw materials from Europe and the United States.

Currently our catalogue of products offers over **11.600 references** and continues in growing process. In order to reach this volume, the company has incorporated new technology, training of personnel, and implementation of an important development policy for suppliers so that all the Value Chain is under one general outline.



INGENIERÍA

La empresa cuenta con un **departamento de ingeniería** altamente capacitado donde permanentemente se desarrollan nuevos productos para satisfacer las demandas de un mercado cada vez más exigente y en constante evolución.

Desde aquí se articula el trabajo de un numeroso plantel con una vasta experiencia técnica y especialización en el rubro. Tanto el diseño como la ejecución de la matricería se realizan dentro de la organización con herramental propio, sin requerir de recursos externos, lo que permite una rápida adaptación a las cambiantes necesidades del mercado y ofrece a los clientes un importante valor agregado.



ENGENHARIA

A empresa possui um **departamento de engenharia** altamente capacitado onde permanentemente são desenvolvidos novos produtos para satisfazer as demandas de um mercado cada vez mais exigente e em constante evolução.

Neste departamento se articula o trabalho de uma numerosa equipe com uma vasta experiência técnica e especialização na área. Tanto o desenho quanto a execução das matrizes são realizadas dentro da empresa com ferramental próprio, sem requerer recursos externos. Isso permite uma rápida adaptação às mudanças das necessidades dos mercados e oferece aos clientes um importante valor agregado.

ENGINEERING

New products are developed continuously in our highly trained **engineering department** to meet the requirements of a market which is ever more demanding and in constant evolution.

From here the company articulates the work of a huge team with a vast technical experience and expertise in the field. The designs as well as the execution of the die making are achieved within the organization with our own tools without having to recur to outsourcing. This allows a quick adaptation to the changing needs of the market and offers the customers a significant added value.



SISTEMA DE GESTIÓN CERTIFICADO ISO 9001
 CERTIFICADO DE SISTEMA DE GESTÃO ISO 9001
 SYSTEM OF MANAGEMENT CERTIFIED ISO 9001

TODO UN EQUIPO, **EXPORTANDO CALIDAD AL MUNDO!**
TODA UMA EQUIPE **EXPORTANDO QUALIDADE PARA O MUNDO!**
A WHOLE TEAM **EXPORTING QUALITY TO THE WORLD!**

ESP EXPORTACIONES

En la actualidad **Juntas Illinois** exporta sus productos a todo el continente americano, a países de Europa y África, en el marco de una política exportadora en permanente desarrollo y búsqueda de nuevos mercados internacionales. Estos resultados representan el 30% de la facturación anual, y ponen de manifiesto el marcado perfil exportador que se viene afirmando con el tiempo.

El trabajo bajo normas ISO, el compromiso con la calidad aplicando tecnologías de última generación, preservando el medio ambiente, la salud y seguridad, caracterizan la responsabilidad de la empresa para cumplir con las necesidades de sus clientes a nivel nacional e internacional.



PORT EXPORTAÇÕES

Atualmente, a **Juntas Illinois** exporta seus produtos para todo o continente americano, para países da Europa e da África, no âmbito de uma política exportadora em permanente desenvolvimento, em busca de novos mercados internacionais. Estes resultados representam 35% do faturamento anual, demonstrando um perfil exportador que se vem firmando com o tempo.

O trabalho sob as normas ISO, o compromisso com a qualidade aplicando tecnologias de última geração e preservando o meio ambiente, a saúde e a segurança caracterizam a responsabilidade da empresa para cumprir com as necessidades de seus clientes tanto nacionais, quanto internacionais.

ENG EXPORTS

Within the framework of the sustained development of an export policy and search of new international markets, **Juntas Illinois** now exports its products to the Americas as well as to African and Asian countries. These outcomes stand for the 35% of the company annual turnover and go to show its strong export profile that consolidates as time passes by.

Responsibility of the company to comply with the needs of its customers on a national and international level is characterized by the **work under the ISO standards**, the commitment of quality by applying the latest new generation technology, preserving the environment, health and security.



VALORES

La meta corporativa de Juntas Illinois S.A. es:
"Ser la mejor opción en calidad, servicio y confiabilidad, de manera tal que nuestros clientes asocien a Juntas Illinois S.A. con la excelencia".

En pos de esta meta, permanentemente buscamos crear y estimular condiciones para que nuestros colaboradores se sientan comprometidos en este proceso de valor y en la aplicación de los principios que sustentan nuestra gestión:

- ▶ Desarrollo personal y profesional de nuestros colaboradores.
- ▶ Compromiso de nuestro personal con la calidad de su trabajo.
- ▶ Compromiso de la Dirección con la calidad y la mejora continua.
- ▶ Relaciones tanto internas como externas regidas bajo normas de ética, honestidad e integridad.
- ▶ Compromiso de nuestro personal para ejecutar sus tareas en alineación a los objetivos de calidad establecidos.



VALORES

A meta corporativa da Juntas Illinois S.A. é:
"Ser a melhor opção em qualidade, serviço e confiabilidade, de forma que nossos clientes associem Juntas Illinois S.A. a excelência".

Atrás desta meta, procuramos permanentemente criar e estimular condições para que nossos colaboradores se sintam comprometidos neste processo de valor e na aplicação dos princípios que sustentam nossa gestão:

- ▶ Desenvolvimento pessoal e profissional de nossos colaboradores.
- ▶ Compromisso de nossos funcionários com a qualidade do trabalho.
- ▶ Compromisso da Direção com a qualidade e melhora contínua.
- ▶ Relações internas e externas regidas sob normas de ética, honestidade e integridade.
- ▶ Compromisso de nossos funcionários para executar tarefas em alinhamento com os objetivos de qualidade estabelecidos.

VALUES

The corporate goal of Juntas Illinois S.A. is:
"To be the best option in quality, service and reliability so our customers can associate Juntas Illinois S.A. with excellence".

In the pursuit of this goal, we are permanently creating and stimulating conditions for our collaborators to help them to commit to this process of value, and to apply the principles that nourish our effort.

- ▶ Personal and professional development of our collaborators.
- ▶ Commitment to quality of work of our personnel.
- ▶ Commitment of Management to quality and constant improvement.
- ▶ Internal and external relations ruled by ethical norms, honesty and integrity.
- ▶ Commitment of our personnel to execute their tasks in alignment with the established quality objectives.

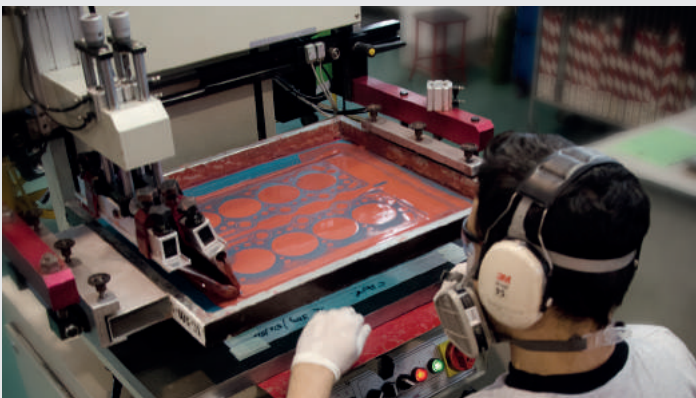

SISTEMA DE GESTIÓN CERTIFICADO ISO 9001
 CERTIFICADO DE SISTEMA DE GESTÃO ISO 9001
 SYSTEM OF MANAGEMENT CERTIFIED ISO 9001

CATÁLOGO ONLINE, **A SÓLO UN CLICK DE DISTANCIA.**
CATÁLOGO ONLINE, **A UM CLIQUE DE DISTÂNCIA.**
ONLINE CATALOG, **JUST A CLICK AWAY.**

ESP Visítenos en **www.juntasillinois.com** donde encontrará información indispensable para el desarrollo de su negocio.

PORT Acesse **www.juntasillinois.com**, e encontre informações indispensáveis para o desenvolvimento do seu negócio.

ENG Visit our **www.juntasillinois.com**, where you will find all the essential information to develop your business.

SECTOR USUARIO E-COMMERCE

SECTOR DE USUARIO E-COMMERCE

USER SECTOR E-COMMERCE

CATÁLOGO ONLINE

CATÁLOGO ONLINE

ONLINE CATALOG

The advertisement features three devices displaying the Illinois E-commerce website. The central laptop screen shows the Illinois logo and the text "E-COMMERCE SECTOR USUARIO". To the left, a tablet displays a search results page for "Juntas" (seals) with various product listings like "JAE-594-E", "JR-736-07R", and "TC-932-20". To the right, a smartphone displays a search filter menu with options for "Marca", "Cilindrada", "Combustible", "Línea", "Utilitario", "Pesada", and "Agrícola".

Ingresá desde tu Smartphone!
Enter do seu Smartphone!
Enter from your Smartphone!

www.juntasillinois.com

ILLINOIS, **CALIDAD CERTIFICADA.**
ILLINOIS, **QUALIDADE CERTIFICADA.**
ILLINOIS, **CERTIFIED QUALITY.**



ESP **Juntas Illinoi S.A.** ha implementado su **Sistema de Gestión** de la Calidad orientando los esfuerzos a satisfacer las expectativas de los clientes en materia de productos y servicios. Para lograr estos objetivos, la empresa trabaja enfocada hacia la mejora continua y monitorea constantemente el nivel de satisfacción a lo largo de toda la Cadena de Valor. Para asegurar que el nivel de calidad de los productos se corresponda con el solicitado por los clientes, la empresa ha extendido las propias exigencias a sus proveedores.

ENG **Juntas Illinoi S. A.** has implemented its **Quality Management System**, orienting the efforts to meet customer expectations in terms of products and services. To achieve these objectives, the company works focused on continuous improvement and constantly monitors the level of satisfaction throughout the entire Value Chain. To ensure the quality of products corresponds to customers's requirements, the company has extended its own exigencies to their suppliers.

PORT **Juntas Illinoi SA** implementou seu **Sistema de Gestão da Qualidade**, orientando os esforços para atender as expectativas dos clientes em termos de produtos e serviços.

Para atingir estes objetivos, a empresa trabalha focada na melhoria contínua e monitora constantemente o nível de satisfação em toda a Cadeia de Valor. Para assegurar a qualidade dos produtos correspondem às exigências dos clientes, a empresa estendeu suas próprias exigências para seus fornecedores.

MÁXIMA CALIDAD: Productos ensayados de acuerdo a normas internacionales SAE 921484, DIN 52913, ASTM F36 y ASTM F37, sometidos a estrictos controles de calidad durante todo el proceso de fabricación. Presentan la combinación de materiales O.E.M. de última generación y máxima calidad. Sistema de Gestión de Calidad certificado ISO 9001:2015 243918-2017-AQ-ARG-RvA

MÁXIMA QUALIDADE: Produto aprovado segundo as normas internacionais SAE 921484, DIN 52913, ASTM F36 e ASTM F37, submetido a rigoroso controle de qualidade durante todo o processo de fabricação. Apresenta a combinação de materiais O.E.M. de última geração e qualidade superior. Sistema de Gestão de Qualidade certificada ISO 9001:2015 243918-2017-AQ-ARG-RvA

TOP GRADE: Product tested according to the following international standards: SAE 921484, DIN 52913, ASTM F36 y ASTM F37. All production is realized under careful quality control throughout the entire manufacturing process. This product has the combination of last generation O.E.M. materials and maximum quality. Quality Management System ISO 9001: 2015 243918-2017-AQ-ARG-RvA



Lack of fulfillment of conditions as set out in the Certification Agreement may render this Certificate invalid.
ACCREDITED UNIT: DNV GL Business Assurance B.V., ZWOLSEWEG 1, 2994 LB, BARENDRECHT, NETHERLANDS. TEL: +311102922689.

ILLINOIS®

ILLINOIS, UN PRODUCTO PARA CADA NECESIDAD DE SELLADO.

ILLINOIS, UM PRODUTO PARA
CADA NECESSIDADE DE VEDAÇÃO.

ILLINOIS, A PRODUCT FOR
EVERY SEALING NEED



YouTube





LÍNEA DE PRODUCTOS

ESP



NUEVO DESARROLLO PARA MOTORES DE ÚLTIMA GENERACIÓN.

METAL GRAF®

PARA MOTORES DIESEL Y GASOLINA DE ALTAS PRESTACIONES



sin amianto

MÁXIMA CALIDAD: Producto ensayado de acuerdo a normas internacionales SAE 921484, DIN 52913, ASTM F36 y ASTM F37, sometido a estricto control de calidad durante todo el proceso de fabricación. Presenta la combinación de materiales O.E.M. de última generación y máxima calidad. Sistema de Gestión de Calidad certificado ISO 9001:2015 (243918-2017-AQ-ARG-RvA).

Con la línea MetalGraf® logramos el equilibrio entre la Junta Standard (fibra) y la Junta Multilámina (MLS), asegurando el perfecto acople de las piezas gracias a su exclusivo diseño.



- ▶ **AISLANTE INTERNO ALTA COMPRESIÓN**
con recubrimiento de grafito.
- ▶ **EXCELENTE RESISTENCIA TÉRMICA**
Soporta presiones y temperaturas más elevadas.
- ▶ **TOTALMENTE ANTIADHERENTE**
- ▶ **MEJOR ADAPTACIÓN**
a las irregularidades de culata y/o block.
- ▶ **MAYOR RESISTENCIA**
frente a la agresión química de anticongelantes y aceites sintéticos.
- ▶ **MEJOR RESPUESTA**
a la contracción y dilatación entre la tapa de cilindros y el block.

TECNOLOGÍA NO RETORQUE

- ▶ Superficial electrostatic coating®
 - ▶ HT neutral sealant bead®
 - ▶ Permanent Torq Tech®
 - ▶ Graphite internal bath®
- Producto apto para motores equipados a GNC y FLEX

METAL GRAF®

PARA MOTORES DIESEL Y GASOLINA DE ALTAS PRESTACIONES



UN MERCADO EN CONSTANTE EVOLUCIÓN

Cada motor a explosión requiere un concepto de junta específico. Para responder a esta exigencia ILLINOIS ofrece, además de las juntas de culata fabricadas con diversos compuestos de fibra **TC PRO®**, la nueva línea **MetalGraf®**, diseñada para los nuevos conceptos de motor.

A diferencia de las MLS (multilamina), las juntas **Metal Graf®** compensan la mayor irregularidad que presentan los motores del mercado de reposición sobre la superficie de culata y/o block. Las juntas MetalGraf® resisten las más severas condiciones de trabajo, soportando mayores presiones y cargas térmicas gracias a su exclusivo diseño que permite reducir ampliamente los valores de contracción y dilatación, característicos en los motores bimetálicos (aluminio/fundición).

EL PROBLEMA

¿Sabe Ud. cual sería la elección acertada ante un recambio de junta MLS (multilamina)? Aparentemente la elección lógica pareciera ser una junta de equipo original. Pero profundizando el tema, encontramos que estas juntas fueron concebidas y diseñadas para sellar un motor nuevo con una superficie/rugosidad menor de 40Ra.

¿Cómo funcionará una junta MLS en un motor del mercado de reposición?

En el aftermarket los motores sufren alteraciones de los materiales y componentes, sumado a que posteriormente obtendrán un rectificado con un acabado de mayor aspereza al original de fábrica.

LA SOLUCIÓN

Los expertos en el mercado de reposición de Juntas Illinois han encontrado la respuesta: **las nuevas juntas de culata MetalGraf®**.

En la actualidad los motores de mayor potencia y compresión exigen juntas de culata de altas prestaciones que demandan una tecnología específica. Temperaturas de operación más elevadas y variables, mayores presiones de combustión y el movimiento constante entre la tapa y el block en motores bimetálicos, requieren de un concepto de junta ideal. La fortaleza técnica de **MetalGraf®** garantiza la efectividad y confiabilidad de todo el sistema, especialmente cuando se trata de motores de encendido por chispa de alta performance y motores diesel de inyección directa.

METAL GRAF

1- COATING ELECTROSTÁTICO SUPERFICIAL

Actúa como deslizante entre las superficies de culata y block para reducir los efectos de contracción y dilatación, sin detrimento del sellado.

2- CORDÓN SELLADOR

Cordón sellador de alto relieve (Silicona AT) que bordea los puntos críticos del sellado. Elimina totalmente el uso de selladores adicionales

3- CAPA FUNCIONAL

Lámina de acero con cobertura realizada por procesos electrolíticos. Elimina la capilaridad en el material de la junta, optimizando la resistencia a la tracción, mejorando las propiedades mecánicas tanto longitudinal como transversalmente.

4- BAÑO SUPERFICIAL DE GRAFITO

Permite que la sección interna de la junta trabaje en forma independiente para contrarrestar los efectos de desgarre provocado por la contracción y dilatación de los materiales.

5- AISLANTE TÉRMICO ALTA COMPRESIÓN

A base de diversos compuestos de fibras y materiales sintéticos densificados. Actúa como compensador de las irregularidades de tapa y/o block formando un colchón elastomérico.

6- ALMA METÁLICA

Núcleo metálico con perforaciones rectangulares altas y bajas que actúan como traba mecánica sobre el material comprimido. Otorga excelentes propiedades físicas, permitiendo una alta recuperación del producto.

7- STOPPER

Círculo perimetral sobre el recorrido de la cámara de combustión que actúa como sellador de gases y limitador de las vibraciones producidas por los mismos.

8- ANILLO PARA LLAMAS

Anillo de sección circular que bordea y refuerza los cilindros, proporcionando mayor resistencia sobre una de las zonas críticas de sellado.

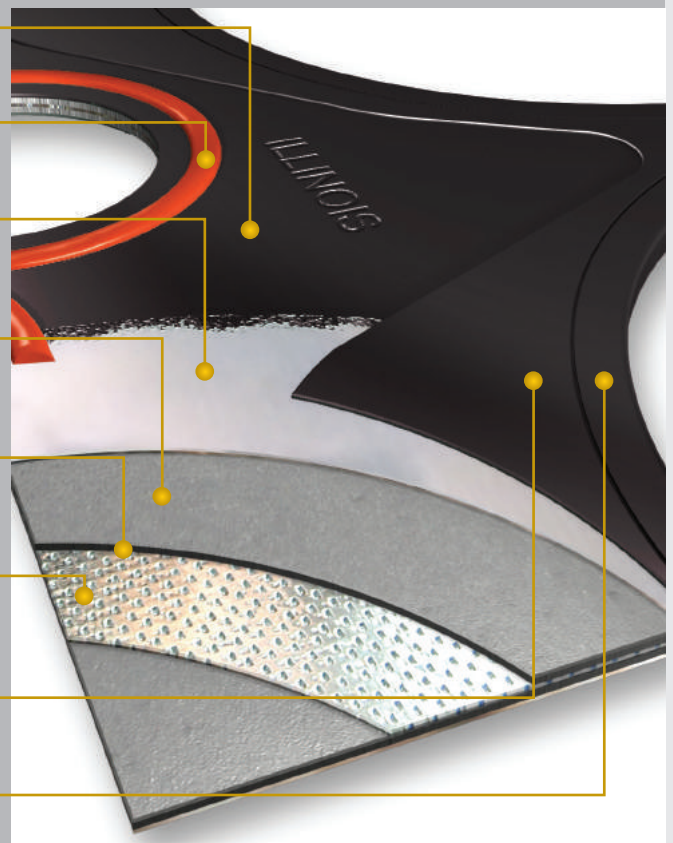

A SIMPLE VISTA, **TODAS LAS JUNTAS
PARECEN SER IGUALES...**

JUNTA STANDARD
TC PRO®
CALIDAD PROFESIONAL

NO COMPROMETA LA CALIDAD.
CONFÍE EN JUNTAS ILLINOIS.

Juntas Illinois presenta su línea de juntas para culata de cilindros TC PRO®, la junta standard de calidad profesional: libre de amianto, producida bajo sistema de gestión de calidad certificada, con materiales de origen alemán y USA.

MÁXIMA CALIDAD: Producto ensayado de acuerdo a normas internacionales SAE 921484, DIN 52913, ASTM F36 y ASTM F37, sometido a estricto control de calidad durante todo el proceso de fabricación. Presenta la combinación de materiales O.E.M. de última generación y máxima calidad. Sistema de Gestión de Calidad certificado ISO 9001:2015 (243918-2017-AQ-ARG-RvA).



- ▶ Non stick coating Tech®
- ▶ HT neutral sealant bead®
- ▶ Permanent Torq Tech®

Producto apto para motores equipados a GNC y FLEX



VERIFICACIÓN DE AUTENTICIDAD

Mediante estos 5 mecanismos de autenticidad, proporcionamos al repuestero y al usuario una representación segura que garantiza y certifica la calidad de nuestros productos.

ETIQUETA TC PRO,
utilizada para identificación visual del nuevo producto ILLINOIS.

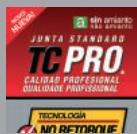

LOGOTIPO
como identificación de la genuina calidad ILLINOIS.

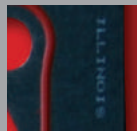

CODIFICACIÓN
numeración correlativa interna.

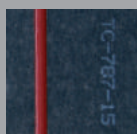

HOLOGRAMA DE SEGURIDAD,
evidencia ante intento de remoción una marca adhesiva con la palabra «VOID»



NÚMERO DE LOTE,
permite determinar la trazabilidad del producto desde su fabricación hasta el punto de venta.

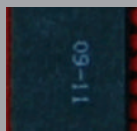

ILLINOIS: Know-how en sellado. Junta standard para culata de cilindros TC PRO®.

Cada motor a explosión requiere un concepto de junta específico. Para responder a los requerimientos particulares que presentan los motores del mercado de reposición, el Departamento de Ingeniería y Desarrollo de Juntas Illinois realizó un intenso trabajo para poner en sus manos lo que hoy presentamos como TC PRO®: juntas standard de diversos compuestos de fibra, elaboradas con materiales ecológicos de última generación de origen alemán y USA.

 **sin amianto**

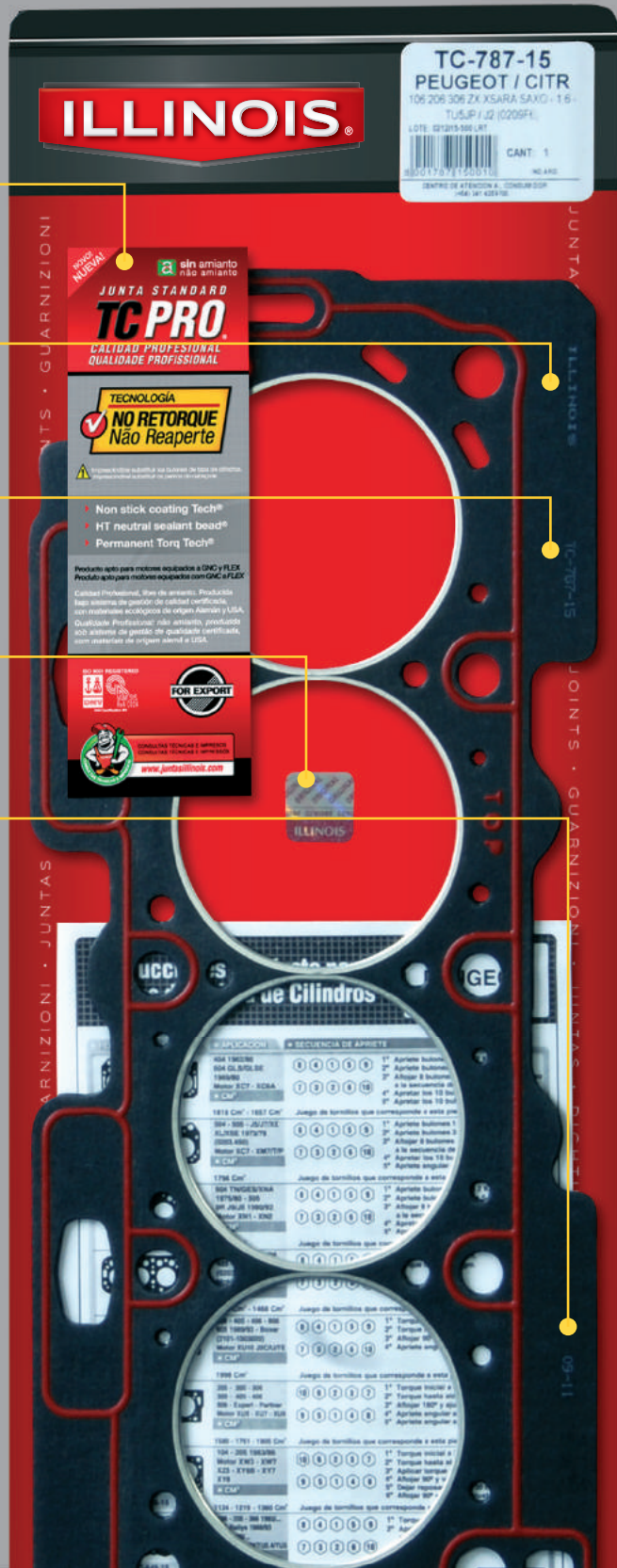

LÍNEA DE SELLADORES Y FORMADORES LÍQUIDOS DE JUNTA

ILLINOIS PRESENTA SU LÍNEA DE SELLADORES Y FORMADORES LÍQUIDOS DE JUNTA.

Los Selladores y Formadores de junta líquida ILLINOIS no contienen solventes, se mantienen inalterados en el tiempo, no encogen, no se cuartean ni endurecen. Presentan **alta resistencia** mecánica a vibraciones y golpes. Rellenan imperfecciones y rayaduras.

Aptos para el sellado de elementos de conducción de agua, aceites y gran variedad de líquidos y gases (evitar contacto directo con solventes y combustibles).

Una de las principales ventajas que ofrece este producto es **la compatibilidad con los materiales sintéticos non-asbestos** (ej. material verde para juntas soft). Los materiales comprimidos sin amianto poseen entre sus compuestos cargas de caucho (NBR) que son **agredidas por el tradicional pega-junta** (con contenido de solventes), provocando el deterioro superficial del material y disminuyendo un 70% las propiedades de resistencia a la carga y presión.



CONSULTAS TÉCNICAS

info@juntasillinois.com
www.juntasillinois.com



TOP GREY®
FORMULACIÓN ESPECÍFICA PARA MOTORES
SPECIFIC ENGINE FORMULA
SELLADOR ALTO MÓDULO NEUTRO OXÍMICO
ALTA TEMPERATURA
PARA PRESTACIÓN



FORMULACIÓN ESPECÍFICA PARA MOTORES

TOP GREY

▷ Sellador alto módulo neutro oxímico

▷ Formajunta RTV Alta Temperatura



| GRIS |

TOP BLACK

▷ Sellador alto módulo neutro oxímico

▷ Formajunta RTV Alta Temperatura



| NEGRO |

ALTA TEMPERATURA

▷ Sellador acético

▷ Formajunta RTV Alta Temperatura



| ROJO |

USO MÚLTIPLE

▷ Adhesivo sellador acético para usos múltiples



| TRANSPARENTE |

ESCAPLUS

▷ Sellador para Sistemas de Escape

▷ Alta Temperatura



| BEIGE |

TOP GREY



**Sellador Alto Módulo Neutro -
Formajunta RTV Alta Temperatura**

Aplicaciones:
Sellos de los extremos del múltiple y escape - Turbos - Caja de velocidad - Tapa distribución - Carter - Tapa de válvulas - Bomba de agua/aceite, etc. Cumple con los requerimientos y especificaciones de desempeño OEM. No aplicarlo sobre juntas para culata de cilindros. No daña sensores de oxígeno. Resiste temperaturas desde -70°C hasta los 280°C (con intermitentes de hasta 330°C)



CÓDIGO	PRESENTACIÓN	COLOR	UNIDAD DE EMPAQUE
2199100	Cartucho 315 gr.	Gris	Pack x 10 unidades
2199200	Pomo 95 gr.	Gris	Pack x 10 unidades

TOP BLACK



**Sellador Alto Módulo Neutro -
Formajunta RTV Alta Temperatura**

Aplicaciones:
Sellos de los extremos del múltiple y escape - Turbos - Caja de velocidad - Tapa distribución - Carter - Tapa de válvulas - Bomba de agua/aceite, etc. Cumple con los requerimientos y especificaciones de desempeño OEM. No aplicarlo sobre juntas para culata de cilindros. No daña sensores de oxígeno. Resiste temperaturas desde -70°C hasta los 280°C (con intermitentes de hasta 330°C)



CÓDIGO	PRESENTACIÓN	COLOR	UNIDAD DE EMPAQUE
2199300	Pomo 70 gr.	NEGRO	Pack x 10 unidades

ALTA TEMPERATURA



**Sellador Acético -
Formajunta RTV
Alta Temperatura**

Aplicaciones:
Tapa de válvulas - Carter - Bomba de agua/aceite - Tapa de distribución, etc. Soporta ataques de ciclos térmicos. Amplio rango de aplicaciones, áreas de alta temperatura en general. No aplicarlo sobre juntas para culata de cilindros. Resiste temperaturas desde -65°C hasta los 280°C (con intermitentes de hasta 320°C)



CÓDIGO	PRESENTACIÓN	COLOR	UNIDAD DE EMPAQUE
2099100	Cartucho 280 ml.	Rojo	Pack x 10 unidades
2099200	Pomo 85 ml.	Rojo	Pack x 10 unidades

USO MÚLTIPLE



**Adhesivo Acético
Uso Múltiple**

Aplicaciones:
Adhesivo para juntas de despiece que no estén expuestas a temperaturas extremas. Reemplaza al pega-junta tradicional. Adhesivo Sellador para juntas soft. Bomba de agua, aceite, cárter, tapa distribución, conexiones de manguera, etc.

Resiste temperaturas desde -30°C hasta los 150°C



CÓDIGO	PRESENTACIÓN	COLOR	UNIDAD DE EMPAQUE
2099300	Cartucho 280 ml.	Transparente	Pack x 10 unidades

ESCAPLUS

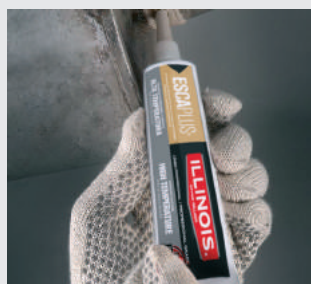

**Sellador para Sistemas de escape
Alta Temperatura**

Aplicaciones: Sellador de empalmes y grietas para el sistema de escape y piezas metálicas expuestas a altas temperaturas. Compuesto especial resistente a los gases y el calor corrosivo del escape. Rellena imperfecciones y ralladuras. Resiste temperaturas desde -5°C hasta los 900°C (con intermitentes de hasta 950°C)



CÓDIGO	PRESENTACIÓN	COLOR	UNIDAD DE EMPAQUE
2099800	Pote 200 gr.	Beige	x unidad



TORNILLOS ILLINOIS, LA REPARACIÓN PROFESIONAL



Para un correcto apriete, reemplace siempre los tornillos de culata de cilindros.

Los tornillos de unión de block y culata deben ser reemplazados sistemáticamente después de cada desmontaje. Las exigencias de apriete de los nuevos conceptos de motor, requieren que los tornillos de culata trabajen sobre la "zona plástica". La fuerza y tracción ejercida en esta selección sumado a la elongación térmica, modifican la estructura original y las propiedades del producto.



¿PORQUÉ NO SE DEBEN REUTILIZAR LOS TORNILLOS?

En el apriete por Kg. la fuerza ejercida sobre el tornillo se encuentra dentro de los límites elásticos del producto; esto significa que cuando uno retira la fuerza aplicada, el tornillo vuelve a su longitud inicial. En éste caso los tornillos no sufren deformaciones (elongaciones), y por tanto podrían ser reutilizados.

En el método angular, los tornillos son sometidos a exigencias que conllevan a deformaciones plásticas (trabajo en la "Zona Plástica"), y a su vez, el régimen variable de temperaturas de los motores modernos amplía los valores de elongación térmica. El estiramiento de la zona plástica es acumulativo. Cuando se trabaja sobre esta sección, el tornillo

pierde memoria de su longitud inicial al ser retirada la fuerza para el desmontaje, lo que imposibilita su reutilización debido a que la capacidad de apriete no corresponde a los requerimientos necesarios para conseguir una correcta unión block-culata. Solamente se puede garantizar la adecuada reparación del motor si se utilizan tornillos nuevos.

Usted pondría en riesgo el éxito de la reparación?

Los estrictos controles de calidad de ILLINOIS, garantizan la seguridad funcional de los tornillos de acuerdo a las especificaciones técnicas de cada tipo de motor.



ELONGACIÓN DE TORNILLOS EN LA ZONA PLÁSTICA



MEDICIÓN DE TORNILLOS

Ejemplo: **M10** x **1.5** x **117**

1

2

3

1 Medición del diámetro del tornillo

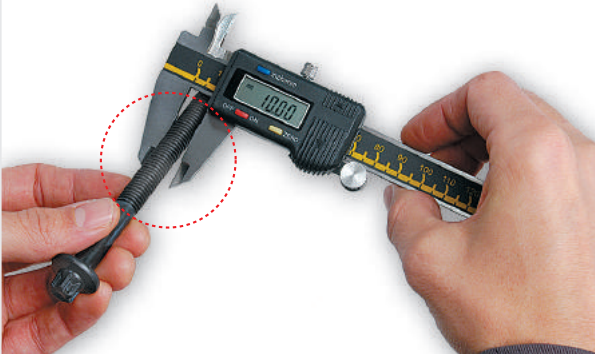

2 Medición del paso de rosca



















3 Medición de la longitud bajo cabeza

3



TIPOS DE CABEZA

-  **HEXAGONAL**
-  **HEXAGONAL CON CUELLO**
-  **HEXAGONAL CON ALA**
-  **HEXAGONAL CON ALA Y CUELLO**
-  **HEXAGONAL CON FLANGE**
-  **HEXAGONAL EMBUTIDA**
-  **HEXAGONAL EMBUTIDA CON ALA**
-  **CILINDRICA SPLINE EMBUTIDO**
-  **CILINDRICA SPLINE EMBUTIDO C/ CUELLO**
-  **CILINDRICA SPLINE EMBUTIDO C/ ALA**
-  **CILINDRICA SPLINE EMBUTIDO C/ FLANGE**
-  **TORX EMBUTIDO**
-  **TORX EMBUTIDO CON CUELLO**
-  **TORX EMBUTIDO CON ALA**
-  **TORX EXTERNO CON ALA**
-  **TORX EXTERNO CON ALA Y CUELLO**
-  **TORX EXTERNO CON FLANGE**
-  **DODECAGONAL EMBUTIDO**
-  **DODECAGONAL EMBUTIDO CON CUELLO**
-  **DODECAGONAL EMBUTIDO CON ALA**
-  **DODECAGONAL EMBUTIDO CON FLANGE**
-  **DODECAGONAL EXTERNO CON ALA**

RECUERDE!!!

En aprietes angulares es imprescindible cambiar los tornillos cada vez que se abra el motor.
Las consecuencias de no cambiar los tornillos de Tapa de Cilindros son más costosas que reemplazarlos.

IMPORTANTE!!!

Siga atentamente las recomendaciones de los informes que acompañan a cada uno de nuestros productos, dado que la evolución de los motores, materiales y cambios tecnológicos han hecho que ciertos procedimientos y algunas prácticas de costumbre queden fuera de lugar y no sean válidas en la actualidad.

RETENES ILLINOIS, BAJA FRICCIÓN MÁXIMA DURABILIDAD

PRODUCTOS DE ESTANQUEIDAD DE ALTA PERFORMANCE

En la actualidad, los motores de mayor potencia y compresión exigen diseños y materiales de altas prestaciones que demandan una tecnología específica. Los retenes ILLINOIS han sido diseñados para cumplir con éstos elevados estándares y niveles de exigencia.



LÍNEAS COMPLETAS: LIVIANA, PESADA, AGRÍCOLA E INDUSTRIAL

- ▶ Retén Bancada
- ▶ Retén Distribución
- ▶ Retén Árbol de levas
- ▶ Retén Cigüeñal
- ▶ Retén Bomba de Aceite
- ▶ Retén Guía de Válvulas
- ▶ Retén PTFE

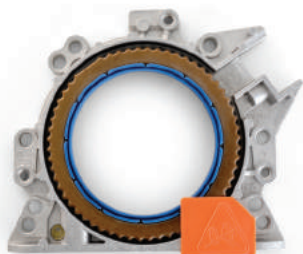

MÁXIMA CALIDAD:

Producto ensayado de acuerdo a normas internacionales, sometido a estricto control de calidad durante todo el proceso de fabricación. Presenta la combinación de materiales O.E.M. de última generación y máxima calidad.



PRINCIPALES DISEÑOS STANDARD (Ø EXTERIOR).

TIPO "L"



Diseños simples, de aplicación convencional. La diferencia principal es la conformación del diámetro exterior, que puede ser de caucho o metal.

TIPO "M"



El caucho permite colocar la pieza en alojamientos dañados y el exterior metálico ofrece un anclaje más firme, pero no rellena los probables daños del alojamiento.

El labio simple o doble es opcional, dependiendo si el medio es agresivo con la contaminación existente.

TIPO "K"



Diseños de estructura reforzada, que ofrecen mayor protección para la zona del labio de retención.

Combinación de diseños L y M.

TIPO "LM"



Se intenta tener un buen anclaje y sellar los posibles surcos o marcas de alojamiento dañado.

PARTES DEL RETÉN

LABIO DE GUARDAPOLVO

Evita contaminación del labio de retención

DIÁMETRO EXTERIOR

En contacto con el alojamiento del retén

LABIO DE RETENCIÓN

Encargado del sello, está en contacto con el elemento en movimiento.

GRABADO IDENTIFICATORIO

RESORTE

Aporta un constante apriete entre el labio y el eje.

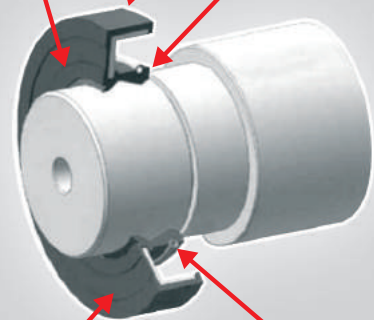

REPARACIÓN DURADERA, CLIENTES SATISFECHOS!

- ▶ Excelentes cualidades sellantes
- ▶ Alta resistencia al desgaste
- ▶ Buena respuesta a shocks térmicos
- ▶ Alta resistencia a los diferentes medios líquidos y gaseosos
- ▶ Facilidad de montaje
- ▶ Larga duración



CONSULTAS TÉCNICAS

info@juntasillinois.com
www.juntasillinois.com

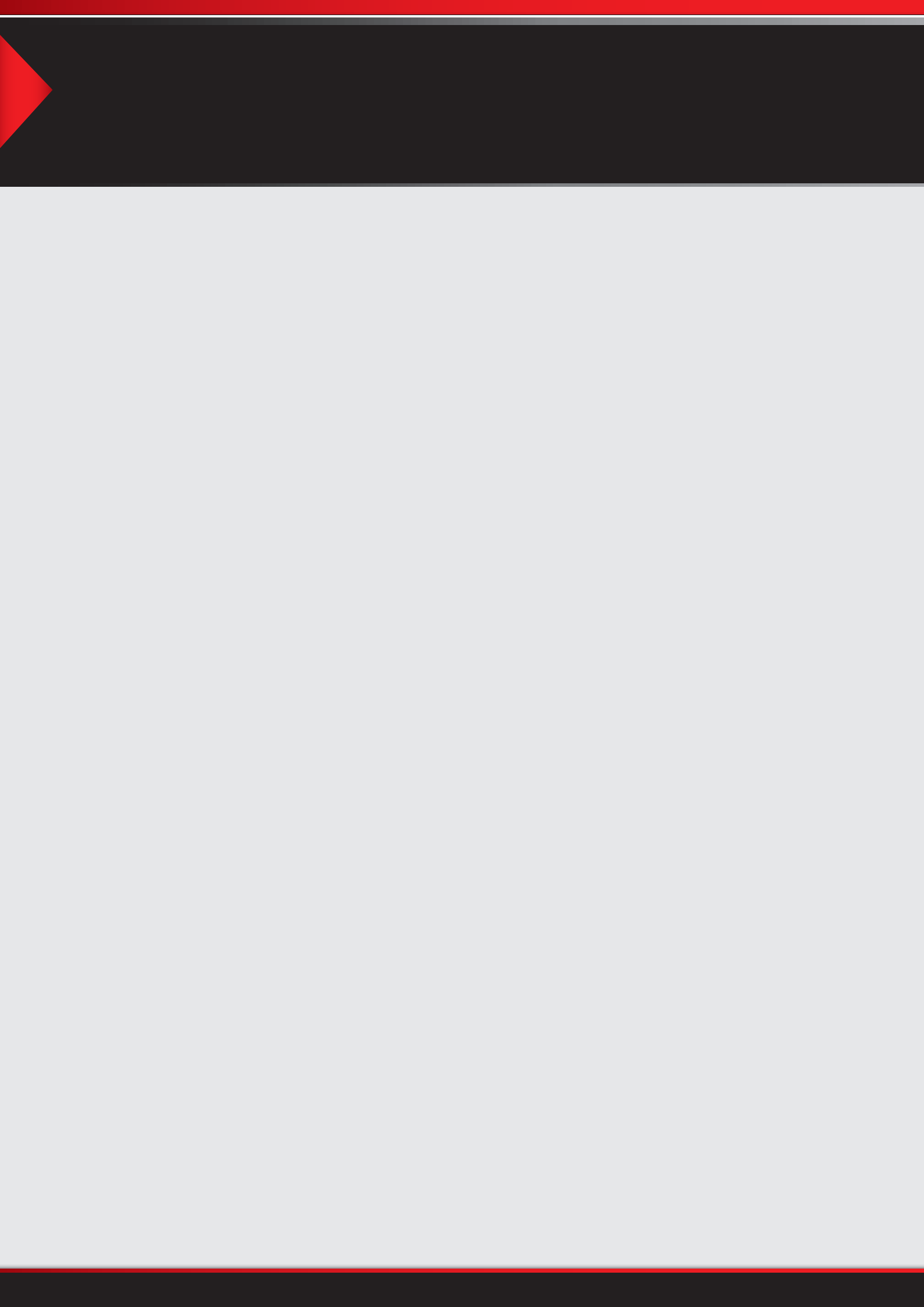



LINHAS DE PRODUTOS

PORT



NOVA TECNOLOGIA PARA MOTORES DE ÚLTIMA GERAÇÃO.

METAL GRAF®

PARA MOTORES DIESEL E GASOLINA DE ALTAS ROTAÇÕES



 sem amianto

MÁXIMA QUALIDADE: Produto aprovado segundo as normas internacionais SAE 921484, DIN 52913, ASTM F36 e ASTM F37, submetido a rigoroso controle de qualidade durante todo o processo de fabricação. Apresenta a combinação de materiais O.E.M. de última geração e qualidade superior. Sistema de Gestão de Qualidade certificada ISO 9001:2015 (243918-2017-AQ-ARG-RvA).

Com a linha MetalGraf® buscamos o equilíbrio entre a Junta Standard (fibra) e a Junta Multi lâmina (MLS), conseguindo o perfeito acoplamento das peças graças a sua exclusiva tecnologia.



- ▶ **ISOLANTE INTERNO**
Alta compressão c/ recobrimento de grafite.
- ▶ **EXCELENTE RESISTÊNCIA TÉRMICA**
Suporta pressões e temperaturas mais elevadas.
- ▶ **TOTALMENTE ANTIADERENTE**
- ▶ **MELHOR ADAPTAÇÃO**
às irregularidades de cabeçote e/ou bloco.
- ▶ **MAIOR RESISTÊNCIA**
perante à agressão química de anticongelantes e óleos sintéticos.
- ▶ **MELHOR RESPOSTA**
a contração e dilatação do motor.

 **NÃO RETORQUE**
TECNOLOGIA

- ▶ Superficial electrostatic coating®
 - ▶ HT neutral sealant bead®
 - ▶ Permanent Torq Tech®
 - ▶ Graphite internal bath®
- Produto apropriado para motores GNV equipada e FLEX

METAL GRAF®

PARA MOTORES DIESEL E GASOLINA DE ALTAS ROTAÇÕES

UM MERCADO EM CONSTANTE EVOLUÇÃO

Cada motor de explosão requer um material específico de junta. Para satisfazer esta exigência a ILLINOIS oferece, além das juntas **TC PRO®**, feitas com vários componentes de fibra, a nova linha **Metalgraf®**, desenhada para as novas tecnologias de motores.

Ao contrário da MLS (multilayer), as juntas **Metalgraf®** compensam as maiores deformações na superfície do cabeçote e bloco dos motores retificados. As juntas **Metalgraf®** resistem as mais severas condições de trabalho, as mais altas pressões e temperaturas graças à sua tecnologia única, o que reduz os valores médios da contração e da expansão nos motores bimetálicos.

O PROBLEMA

Você sabe qual a escolha certa diante de uma troca de junta MLS (Multi Lâmina) ? Aparentemente, a escolha lógica seria uma junta original. Mas, nós nos aprofundamos no tema e descobrimos que estas juntas foram produzidas e desenhadas para selar um motor novo com uma superfície /rugosidade com menos de 40 Ra.

Como funcionará uma junta MLS em um motor retificado?

Devido as altas temperaturas todo motor sofre deformação natural e após a retifica não se obtém um acabamento perfeito como o original de fábrica.

A SOLUÇÃO

Os especialistas no mercado de reposição de Juntas Illinois têm encontrado a resposta: **as novas juntas de cabeçote MetalGraf®**. Na atualidade os motores de maior potência e compressão exigem juntas de cabeçote de altas rotações que demandam uma tecnologia específica. Temperaturas de operação mais elevadas e variáveis, maiores pressões de combustão e o movimento constante entre a cabeçote e bloco em motores bimetálicos, requerem um conceito de junta ideal. A fortaleza técnica da **MetalGraf®** garante a efetividade e confiabilidade de todo o sistema sob as mais severas condições de trabalho, especialmente quando se trata de motores de ignição por centelha de alta performance e motores diesel de injeção direta.

METAL GRAF

1- COATING ELETROSTÁTICO SUPERFICIAL

Atua como deslizante entre as superfícies de cabeçote e bloco para reduzir os efeitos de contração e dilatação, sem detrimento do selado.

2- CORDÓN SELLADOR

Cordão de vedação de alto relevo (Silicone AT) que envolve os pontos críticos de vedação. Elimina totalmente o uso de seladores adicionais.

3- CAMADA FUNCIONAL

Lâmina de aço com cobertura feita por processos eletrolíticos. Elimina a capilaridade no material da junta, otimizando a resistência à tração, melhorando as propriedades mecânicas tanto longitudinal quanto transversalmente.

4- BANHO SUPERFICIAL DE GRAFITE

Permite que a seção interna da junta trabalhe de forma independente para neutralizar os efeitos de ruptura provocado pela contração e dilatação dos materiais.

5- ISOLANTE TERMICO ALTA COMPRESSÃO

A base de diversos compostos de fibras e materiais sintéticos mais densos. Atua como compensador das irregularidades de tampa e/ou bloco formando um colchão elastomérico.

6- A MANTA METÁLICA

A manta metálica com perfurações regulares altas e baixas que atuam como trava mecânica sobre o material comprimido. Outorga excelentes propriedades físicas, permitindo uma alta recuperação do produto.

7- STOPPER

Circuito perimetral sobre o trajeto da câmara de combustão que atua como selador de gases e limitador das vibrações produzidas pelos mesmos.

8- ANEL DA CÂMARA DE COMBUSTÃO

Anel de seção circular que envolve a boca dos cilindros proporcionando maior resistência sobre uma das zonas críticas de vedação.

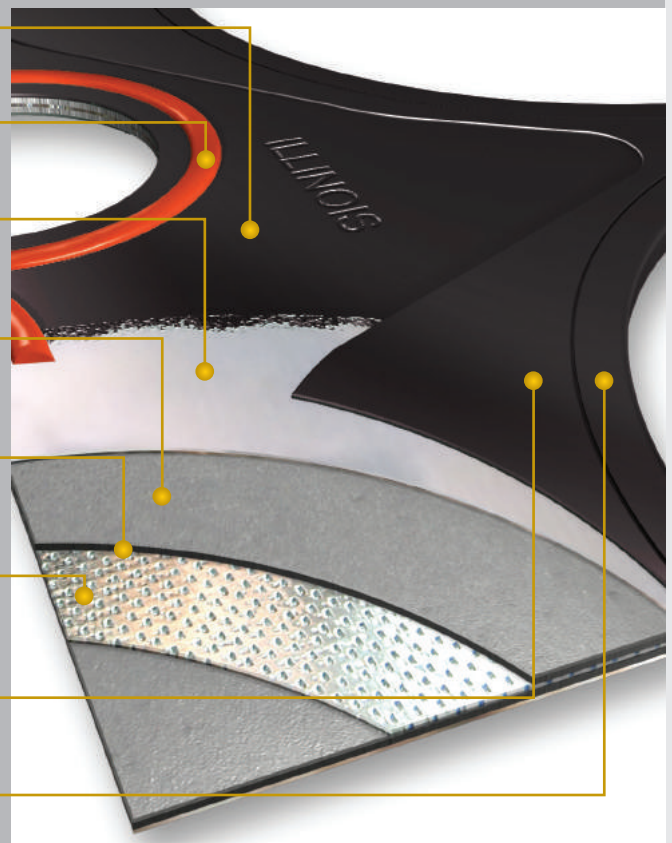

**TODAS AS JUNTAS TÊM A MESMA APARÊNCIA,
À PRIMEIRA VISTA...**

JUNTA STANDARD
TC PRO®
CALIDAD PROFESIONAL

**NÃO COMPROMETA A QUALIDADE...
CONFIE EM JUNTAS ILLINOIS.**

Juntas Illinois apresenta sua linha de juntas para cabeçote de cilindros TC PRO®, a junta standard de qualidade profissional: não amianto, produzida sob sistema de gestão de qualidade certificada, com materiais de origem alemã e USA.

MÁXIMA QUALIDADE: Produto aprovado segundo as normas internacionais SAE 921484, DIN 52913, ASTM F36 e ASTM F37, submetido a rigoroso controle de qualidade durante todo o processo de fabricação. Apresenta a combinação de materiais O.E.M. de última geração e qualidade superior. Sistema de Gestão de Qualidade certificada ISO 9001:2015 (243918-2017-AQ-ARG-RvA).



- ▶ Non stick coating Tech®
- ▶ HT neutral sealant bead®
- ▶ Permanent Torq Tech®

Produto apropriado para motores GNV equipada e FLEX



VERIFICAÇÃO DE AUTENTICIDADE

Através destes 5 mecanismos de autenticidade, fornecemos ao usuário uma representação segura que garante e certifica a qualidade dos nossos produtos.

ETIQUETA TC PRO,
Fornecemos ao usuário uma representação visual do novo produto ILLINOIS.

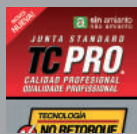

IMPRESSÃO DO LOGOTIPO
como a identificação da genuína qualidade ILLINOIS.

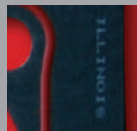

CODIFICAÇÃO
Numeração interna correlativa.

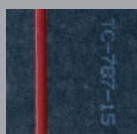

HOLOGRAMA DE SEGURANÇA,
identifica a tentativa de violação da embalagem aparecendo uma marca adesiva com a palavra «VOID»



IMPRESSÃO DO NÚMERO DO LOTE,
permite rastrear o produto desde sua fabricação até o ponto de venda.

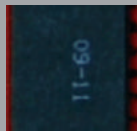

ILLINOIS: Know-How em selado. Junta standard para cabeçote de cilindros TC PRO®.

Cada motor a explosão requer um modelo específico para atender particularidades que apresentam os motores do mercado de reposição, o Departamento de Engenharia e Desenvolvimento de Juntas Illinois realizou um intenso trabalho para pôr em suas mãos o que hoje apresentamos como TC PRO®: juntas standard de diversos compostos de fibra, elaboradas com materiais ecológicos de última geração de origem alemã e USA.

 **não amianto**

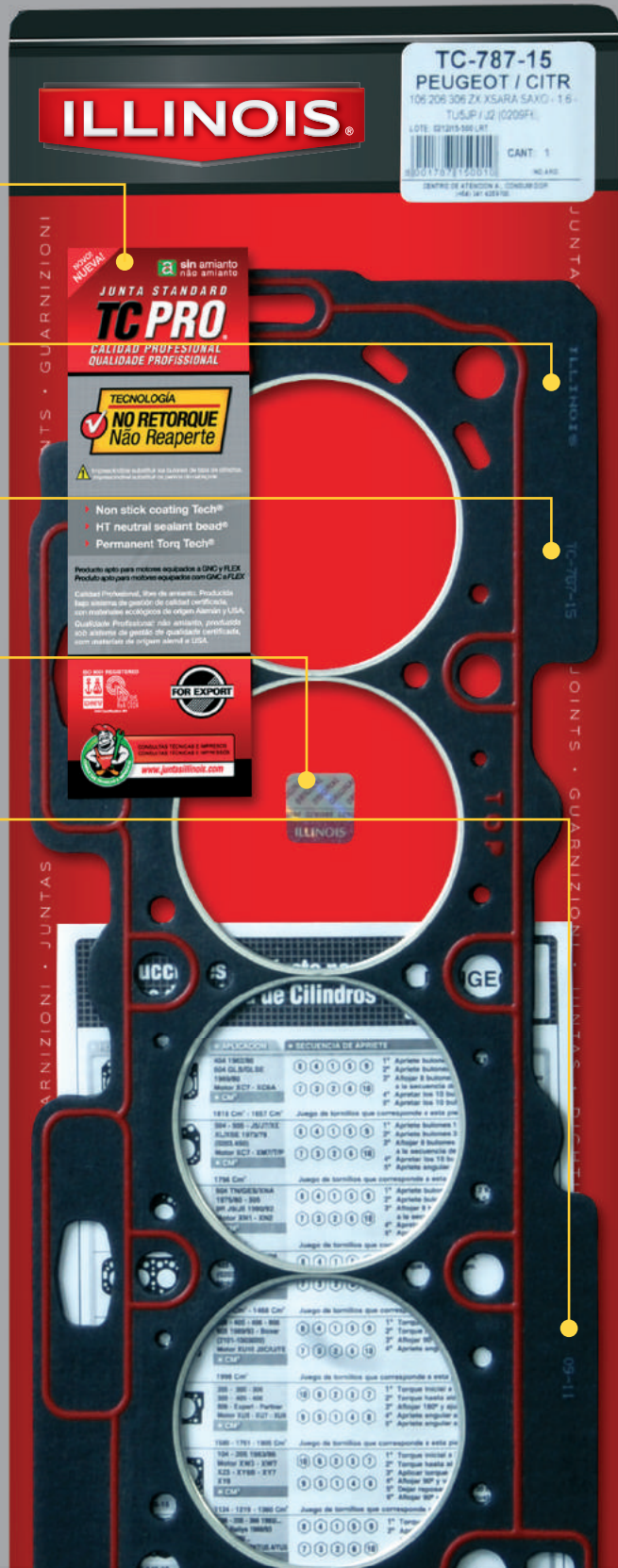

LINHA DE SELADORES E FORMADORES DE JUNTA LÍQUIDA

ILLINOIS APRESENTA A LINHA DE SELADORES E FORMADORES DE JUNTA LÍQUIDA.

Os Seladores e Formadores de junta líquida ILLINOIS não contêm solventes, mantêm-se inalterados no tempo, não encolhem, não racham e nem endurecem. Apresentam **alta resistência** mecânica a vibrações e golpes.

Preenchem imperfeições e ranhuras. Próprios para vedação de elementos de condução de água, óleos e grande variedade de líquidos e gases.

Uma das principais vantagens do produto é a sua **compatibilidade com materiais sem amianto**. Produtos sem amianto tem em sua composição a borracha, que em contato com produtos a base de solvente danificam a superfície do material e diminui a resistência à carga e pressão em 70%.



CONSULTAS TÉCNICAS

info@juntasillinois.com
www.juntasillinois.com



FORMULAÇÃO ESPECÍFICA PARA MOTORES

TOP GREY

▶ Selador Alto Módulo Neutro

▶ Forma junta RTV Alta Temperatura



| CINZA |

TOP BLACK

▶ Selador alto módulo neutro oximico

▶ Forma junta RTV Alta Temperatura



| PRETO |

ALTA TEMPERATURA

▶ Selador acético

▶ Formajunta RTV Alta Temperatura



| VERMELHA |

USO MÚLTIPLE

▶ Adesivo selador acético para usos múltiples



| TRANSPARENTE |

ESCAPLUS

▶ Selador para Sistemas de Escapamento

▶ Alta Temperatura



| BEGE |

TOP GREY



**Selador Alto Módulo Neutro -
Forma junta RTV Alta Temperatura**

Aplicações:
Vedação dos extremos do coletor e escapamento - Turbos - Caixa de câmbio - Tapa distribuição - Câter - Tapa de válvulas - Bomba de água/óleo, etc. Cumpre com os requerimentos e especificações de desempenho OEM. Não aplicar sobre juntas de cabeçote. Não danifica sensores de oxigênio.

Resiste a temperaturas que vão de -70°C até 280°C (com intermitentes de até 3230°C)



CÓDIGO	APRESENTAÇÃO	COR	UNIDADE DE EMPAQUETAMENTO
2199100	Tubo 315 gr.	Cinza	Pack x 10 unidades
2199200	Bisnaga 95 gr.	Cinza	Pack x 10 unidades

TOP BLACK



**Selador Alto Módulo Neutro -
Forma junta RTV Alta Temperatura**

Aplicações:
Sellos de los extremos del múltiple y escape - Turbos - Caja de velocidad - Tapa distribución - Câter - Tapa de válvulas - Bomba de água/óleo, etc. Cumple con los requerimientos y especificaciones de desempeño OEM. No aplicarlo sobre juntas para culata de cilindros. No daña sensores de oxígeno.

Resiste temperaturas desde -70°C hasta los 280°C (con intermitentes de hasta 330°C)



CÓDIGO	APRESENTAÇÃO	COR	UNIDADE DE EMPAQUETAMENTO
2199300	Bisnaga 70 gr.	PETRO	Pack x 10 unidades

ALTA TEMPERATURA



**Selador - Forma junta
RTV Alta Temperatura**

Aplicações:
Tapa de válvulas - Câter - Bomba de água/óleo - Tapa de distribuição, etc. Suporta variações do ciclo térmico. Ampla gama de aplicações em qualquer área de alta temperatura. Não aplicar sobre juntas de cabeçote.

Resiste a temperaturas que vão de -65°C até 280°C (com intermitentes de até 320°C)



CÓDIGO	APRESENTAÇÃO	COR	UNIDADE DE EMPAQUETAMENTO
2099100	Tubo 280 ml.	Vermelha	Blister x 10 unidades
2099200	Bisnaga 85 ml.	Vermelha	Blister x 10 unidades

USO MÚLTIPLE



Adesivo Uso Múltiple

Aplicações:
Adesivo para juntas pré-fabricadas que não estiverem expostas a temperaturas extremas. Substitui adesivo tradicional. Vedante para juntas soft, bomba de água, bomba de óleo, câter, tampa de distribuição, conexões de mangueira, etc.

Tolerância de temperaturas desde -30°C até + 150°C.



CÓDIGO	APRESENTAÇÃO	COR	UNIDADE DE EMPAQUETAMENTO
2099300	Tubo 280 ml.	Transparente	Pack x 10 unidades

ESCAPLUS

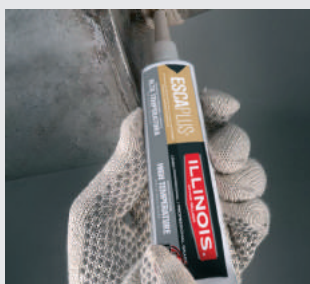

**Selador para Sistemas de escapamento
Alta Temperatura**

Aplicações: Vedador de emendas e gretas para o sistema de escapamento e peças metálicas expostas a altas temperaturas. Composto especial resistente aos gases e ao calor corrosivo do escapamento. Corrige imperfeições e rachaduras. Para a vedação de elementos de condução de gases, óleos e grande variedade de líquidos.

Resiste a temperaturas que vão de -5°C até 900°C (com intermitentes de até 950°C)



CÓDIGO	APRESENTAÇÃO	COR	UNIDADE DE EMPAQUETAMENTO
2099800	Pote 200 gr.	Bege	x unidade

PARAFUSOS ILLINOIS, REPARAÇÃO PROFISSIONAL



Para um correto aperto, substitua sempre os parafusos de cabeçote de cilindros.

Os parafusos de união de bloco e cabeçote devem ser substituídos sistematicamente depois de cada desmontagem.

As exigências de aperto dos novos modelos de motor, requerem que os parafusos de cabeçote trabalhem sobre a "zona plástica". A força e tração exercida nesta seleção somada a deformação térmica, modificam a estrutura original e as propriedades do produto.



POR QUE NÃO DEVEM SER REUTILIZADOS OS PARAFUSOS?

No aperto por Kg, a força exercida sobre o parafuso se encontra dentro dos limites elásticos do produto; isto significa que quando é retirada a força aplicada, o parafuso volta a sua longitude inicial. Neste caso, os parafusos não sofrem deformações, portanto, poderiam ser reutilizados.

Em apertos angulares, o parafuso recebe uma importante tensão que provoca deformações plásticas (trabalha sobre a "zona plástica"); entretanto, o regime variável das temperaturas dos motores modernos expande os valores de alongamento térmico. Alongamento na "zona plástica" é acumulativo. Ao trabalhar nessa seção, o parafuso perde a memória

de seu comprimento inicial quando retirado na desmontagem. Esta é a razão pela qual se torna impossível a reutilização, porque a capacidade de fixação não corresponde as exigências de uma união apropriada do bloco e cabeçote. O bom reparo do motor só é garantido se você estiver usando parafusos novos.

Você arriscaria o sucesso da reparação? Nosso rígido controle de qualidade, garante a segurança dos parafusos, de acordo com as especificações técnicas de cada tipo de motor.



DEFORMAÇÃO DE PARAFUSOS NA ZONA PLÁSTICA.



MEDIÇÃO DE PARAFUSOS

Exemplo: **M10** x **1.5** x **117**

1

2

3

1

Medição do diâmetro do parafuso

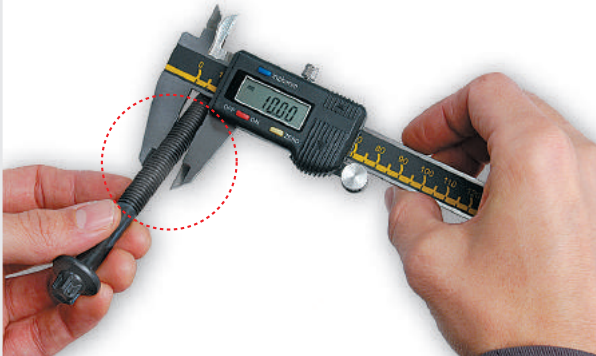

2

Medição do passo de rosca















































3

Medição da longitude sob cabeça



TIPO DE CABEÇAS:

-   **SEXTAVADA**
-   **SEXTAVADA COM COLARINHO**
-   **SEXTAVADA COM ABA**
-   **SEXTAVADA COM ABA E COLARINHO**
-   **SEXTAVADA FLANGEADA**
-   **SEXTAVADA EMBUTIDA**
-   **SEXTAVADA EMBUTIDA COM ABA**
-   **CILÍNDRICA SPLINE EMBUTIDO**
-   **CILÍNDRICA SPLINE EMBUTIDA COM COLARINHO**
-   **CILÍNDRICA SPLINE EMBUTIDA COM ABA**
-   **CILÍNDRICA SPLINE EMBUTIDO FLANGEADA**
-   **TORX EMBUTIDO**
-   **TORX EMBUTIDO COM COLARINHO**
-   **TORX EMBUTIDO COM ABA**
-   **TORX EXTERNO COM ABA**
-   **TORX EXTERNO COM ABA E COLARINHO**
-   **TORX EXTERNO FLANGEADA**
-   **DODECAÉDRICA EMBUTIDO**
-   **DODECAÉDRICA EMBUTIDO COM COLARINHO**
-   **DODECAÉDRICA EMBUTIDO COM ABA**
-   **DODECAÉDRICA EMBUTIDO FLANGEADA**
-   **DODECAÉDRICA EXTERNO COM ABA**

LEMBRE!!!

Em apertos angulares é imprescindível trocar os parafusos cada vez que se abra o motor.
As conseqüências de não trocar os parafusos da Cabeçote dos Cilindros são mais custosas que substituí-las.

IMPORTANTE!!!

Siga atentamente as recomendações dos informativos que acompanham cada um de nossos produtos, porque a evolução dos motores, materiais e mudanças tecnológicas têm mostrado que certos procedimentos e algumas práticas de costume ficaram ultrapassadas e não sejam válidas na atualidade.

RETENTORES ILLINOIS, BAIXO ATRITO MÁXIMA DURABILIDADE

PRODUTOS DE VEDAÇÃO DE ALTO DESEMPENHO

Atualmente, os motores de maior potência e compressão exigem projetos e materiais de alto desempenho, que demandam uma tecnologia específica. Os Retentores ILLINOIS foram desenvolvidos para atender a esses elevados níveis de exigência.



LINHAS COMPLETAS: LEVE, COMERCIAL, PESADA, AGRÍCOLA E INDUSTRIAL

- ▶ Retentor do Virabrequim
- ▶ Retentor da Distribuição
- ▶ Retentor do Comando de Válvulas
- ▶ Retentor da Haste de Válvula
- ▶ Retentor PTFE (Teflon)

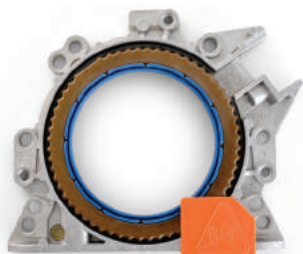

MÁXIMA QUALIDADE:

Produto testado de acordo com as Normas Internacionais, sujeito a um rigoroso controle de qualidade durante todo o processo de fabricação. Apresenta a combinação de materiais OEM de última geração e alta qualidade.



PRINCIPAIS PERFIS STANDARD (Ø EXTERNO).

TIPO "L"



Perfil simples, aplicação convencional. A principal diferença é o material aplicado na construção externa, que pode ser de borracha ou de metal.

A construção em borracha permite a montagem do Retentor em alojamentos danificados, ou seja, que apresentem apenas riscos ou pequenas corrosões. Já a construção metálica, oferece uma ancoragem mais firme, porém não é indicado para alojamentos que apresentem as mesmas condições de danos.

TIPO "M"



Lábio simples ou duplo são opções de construção. O lábio duplo oferece uma proteção adicional, caso o ambiente seja mais agressivo, com presença de contaminantes abrasivos.

TIPO "K"

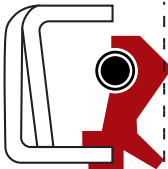

Perfis de estrutura reforçada, que oferecem uma melhor proteção para a área dos lábios de vedação.

Combinando padrões L e M.

TIPO "LM"

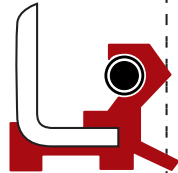

Têm como objetivo uma melhor ancoragem e a vedação de pequenas ranhuras e/ou corrosões.

PARTES DO RETENTOR

RETENTOR DE POEIRA

Impede a contaminação do lábio de vedação.

DIÂMETRO EXTERNO

Em contato com o alojamento do Retentor.

LÁBIO DE VEDAÇÃO

É a alma do Retentor. Está em contato com o elemento móvel, garantindo a vedação.

GRAVAÇÃO DA REFERÊNCIA

MOLA

Garante o torque constante entre o lábio e o eixo.

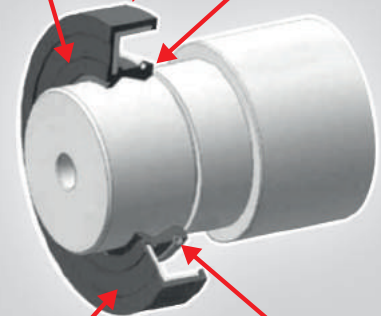

REPARAÇÃO DURADOURA, CLIENTES SATISFEITOS !

- ▶ Excelentes características de vedação
- ▶ Alta resistência a desgastes
- ▶ Boa resposta a choques térmicos
- ▶ Alta resistência às agressões de líquidos e gases
- ▶ Fácil montagem
- ▶ Longa vida útil



CONSULTAS TÉCNICAS

info@juntasillinois.com
www.juntasillinois.com

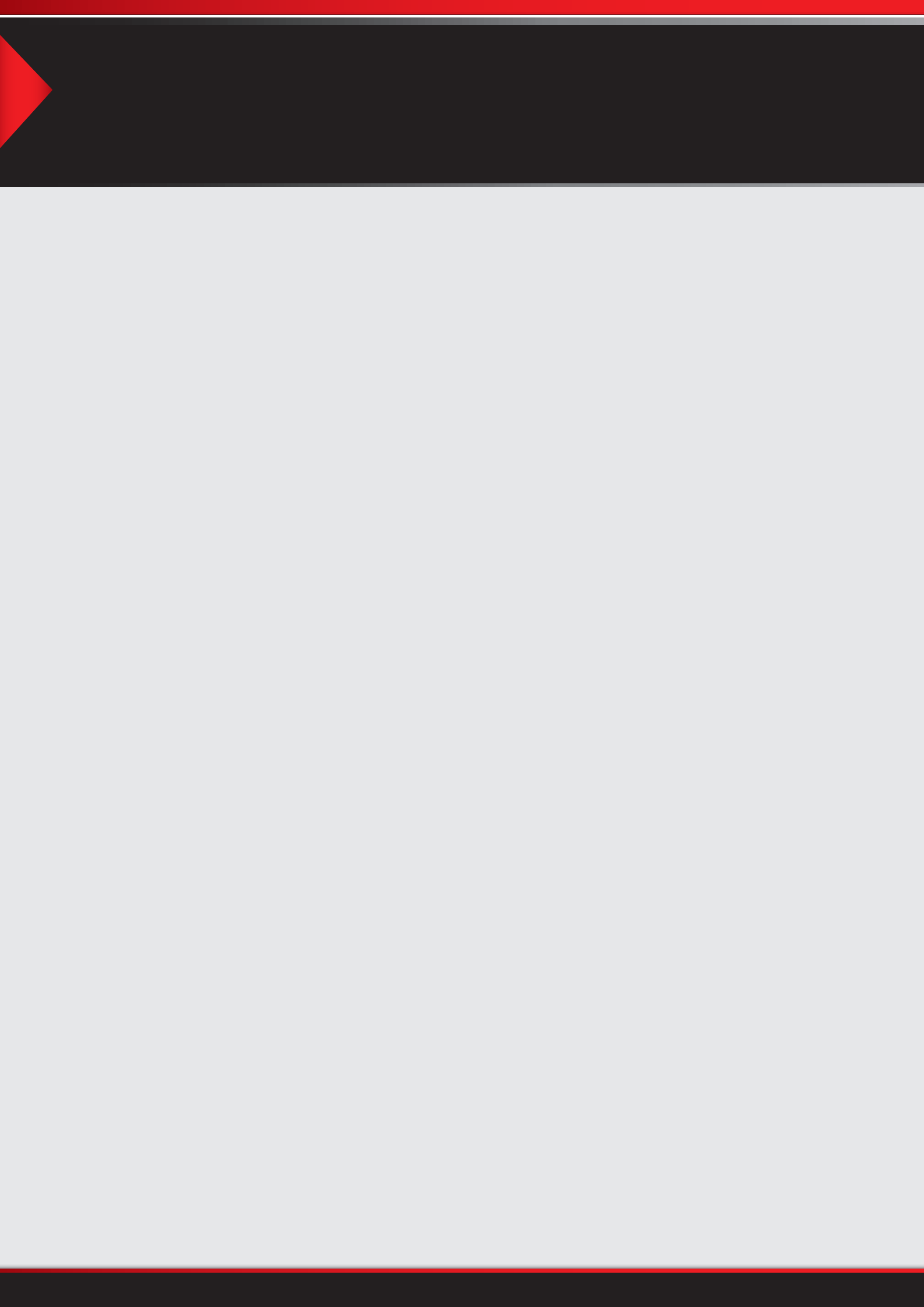



PRODUCT LINES

ENG



DEVELOPMENT FOR NEXT-GENERATION ENGINES

METAL GRAF®

FOR HIGH PERFORMANCE DIESEL AND GAS ENGINES



non asbestos

TOP GRADE: Product tested according to the following international standards: SAE 921484, DIN 52913, ASTM F36 y ASTM F37. All production is realized under careful quality control throughout the entire manufacturing process. This product has the combination of last generation O.E.M. materials and maximum quality. Quality Management System ISO 9001:2015 (243918-2017-AQ-ARG-RvA).

With the MetalGraf® line, we get the balance between the Standard Gasket (fiber) and the Multilayer Gasket (MLS), assuring the perfect fitting of pieces thanks to its exclusive design.



- ▶ **INTERNAL INSULATION**
High Compression with graphite coating.
- ▶ **EXCELLENT THERMIC ENDURANCE**
It endures the highest pressures and temperatures.
- ▶ **COMPLETELY NONSTICK**
- ▶ **BETTER ADJUSTMENT**
to irregularities in heads and/or blocks.
- ▶ **GREATEST ENDURANCE**
to chemical aggression of antifreezes and synthetic oils.
- ▶ **BETTER RESPONSE**
to engine contraction and expansion.

**NO RETORQUE
TECHNOLOGY**

- ▶ Superficial electrostatic coating®
 - ▶ HT neutral sealant bead®
 - ▶ Permanent Torq Tech®
 - ▶ Graphite internal bath®
- Product suitable for engines fitted CNG and FLEX

METAL GRAF®

FOR HIGH PERFORMANCE DIESEL AND GAS ENGINES



A MARKET IN CONSTANT EVOLUTION

Each explosion engine requires a specific concept of gasket. To respond this requirement ILLINOIS offers, in addition to the **TC PRO®**, manufactured with fiber compound, the new line **Metalgraf®**, especially designed for new engine concepts.

Unlike the MLS (multilayer) gaskets, the **Metalgraf®** can compensate the increased roughness that have the engines of the after sales market on their head and block surfaces. The **Metalgraf®** gasket resists the most severe working conditions, enduring the highest pressures and temperatures thanks to its exclusive design that reduces the average values of contraction and expansion in bimetallic engines.

THE PROBLEM

Do you know which would be the correct choice when deciding a spare of MLS gaskets (multilayer)?

Apparently, the logical choice seems to be an original equipment gasket. But if we go into this topic in depth, we will find these gaskets were developed and designed to seal a new engine with a surface / roughness of at least 40 Ra.

How will a MLS gasket work in an engine of the replacement market?

In the after sales market, engines suffer changes in their materials and components, adding that later they will get a rectification with a greater roughness finish than that of the manufacturing original.

THE SOLUTION

Experts in the replacement market of Juntas Illinois have found the answer to the problem: **the new MetalGraf® head gaskets.**

Nowadays, engines with greater power and compression need high-performance head gaskets which demand a specific technology.

Higher and variable operative temperatures, greater combustion pressure and the constant movement between the cap and the block in bimetallic engines require an ideal concept of gasket. The technical strength of **MetalGraf®** guarantees effectiveness and reliability in the entire system under the most severe working conditions, especially when dealing with spark ignition engines of high performance and direct injection diesel engines.

METAL GRAF

1- SUPERFICIAL ELECTROSTATIC COATING

It works as a slipping between the head and block surfaces to reduce the effects of contraction and expansion, with no detriment to the sealing.

2- SEALANT CORD

High prominence sealant cord (AT silicone) which goes around the critical sealing points. It eliminates completely the use of additional sealants.

3- FUNCTIONAL COATING

Steel sheet with coating produced by electrolytic processes. It eliminates the capillarity in the gasket material, optimizing traction endurance and improving the mechanical properties in both longitudinal and trasverse directions.

4- SUPERFICIAL GRAPHITE BATH

It allows the internal gasket section to work independently to counteract the effects of tearing provoked by the contraction and expansion of the materials.

5- HIGH-COMPRESSION THERMIC INSULATION

Based on different fiber compounds and synthetic materials densified. It acts as a compensator of the irregularities of the cap and/or block forming an elastomeric cushion.

6- METALLIC CORE

Metallic core with high and low rectangular drillings that act as a mechanical block over the compressed material. It offers excellent physical properties, allowing a high product recovery.

7- STOPPER

Perimeter circuit over the path of combustion chamber which works as a gas sealant and a limiting agent to the vibrations produced by it.

8- FLAME RING

Circular section ring which goes around and strengthens the cylinders, providing greater endurance over one of the critical sealing areas.

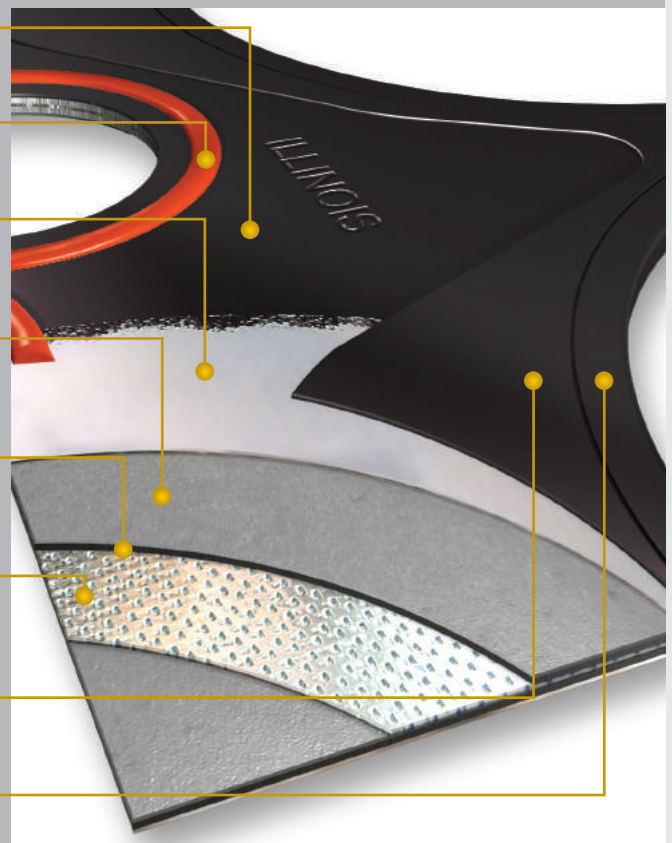

**ALL HEAD GASKETS LOOK THE SAME
AT A FIRST SIGHT...**

JUNTA STANDARD
TC PRO®
CALIDAD PROFESIONAL

**DON'T COMPROMISE QUALITY...
TRUST JUNTAS ILLINOIS.**

Juntas Illinois presents its line of TC PRO® cylinder head gaskets, the standard gasket of professional quality: free of asbestos, produced under the certified quality management system, with materials made in Germany and USA.

TOP GRADE: Product tested according to the following international standards: SAE 921484, DIN 52913, ASTM F36 y ASTM F37. All production is realized under careful quality control throughout the entire manufacturing process. This product has the combination of last generation O.E.M. materials and maximum quality. Quality Management System ISO 9001:2015 (243918-2017-AQ-ARG-RvA).



- ▶ Non stick coating Tech®
- ▶ HT neutral sealant bead®
- ▶ Permanent Torq Tech®

Product suitable for engines fitted CNG and FLEX



AUTHENTICITY CHECK

Through these four mechanisms of authenticity, we provide the user a secure representation that ensures and certifies the quality of our products.

TC PRO LABEL,
used to identify visually the new ILLINOIS product.



LOGOTYPE
As identification of ILLINOIS's genuine quality.

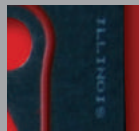

ENCODING
Correlative internal numbering.

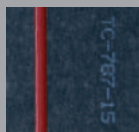

SECURITY HOLOGRAM,
proof against removal attempt: adhesive trade mark with the word "VOID" on it.



LOT NUMBER,
allows to determine the route of the product since its manufacture to the point of sales.

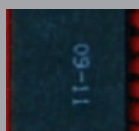

ILLINOIS: Know-How in sealings. Standard TC PRO® cylinder head gaskets.

Each explosion engine requires a specific concept of gasket. In order to attend to the specific requirements that display the engines of the replacement market, the Juntas Illinois Engineering and Developing Department did an intense job to offer you what we present today as TC PRO®: standard gaskets of diverse fiber compounds, produced with cutting-edge ecological materials made in Germany and USA.



non asbestos

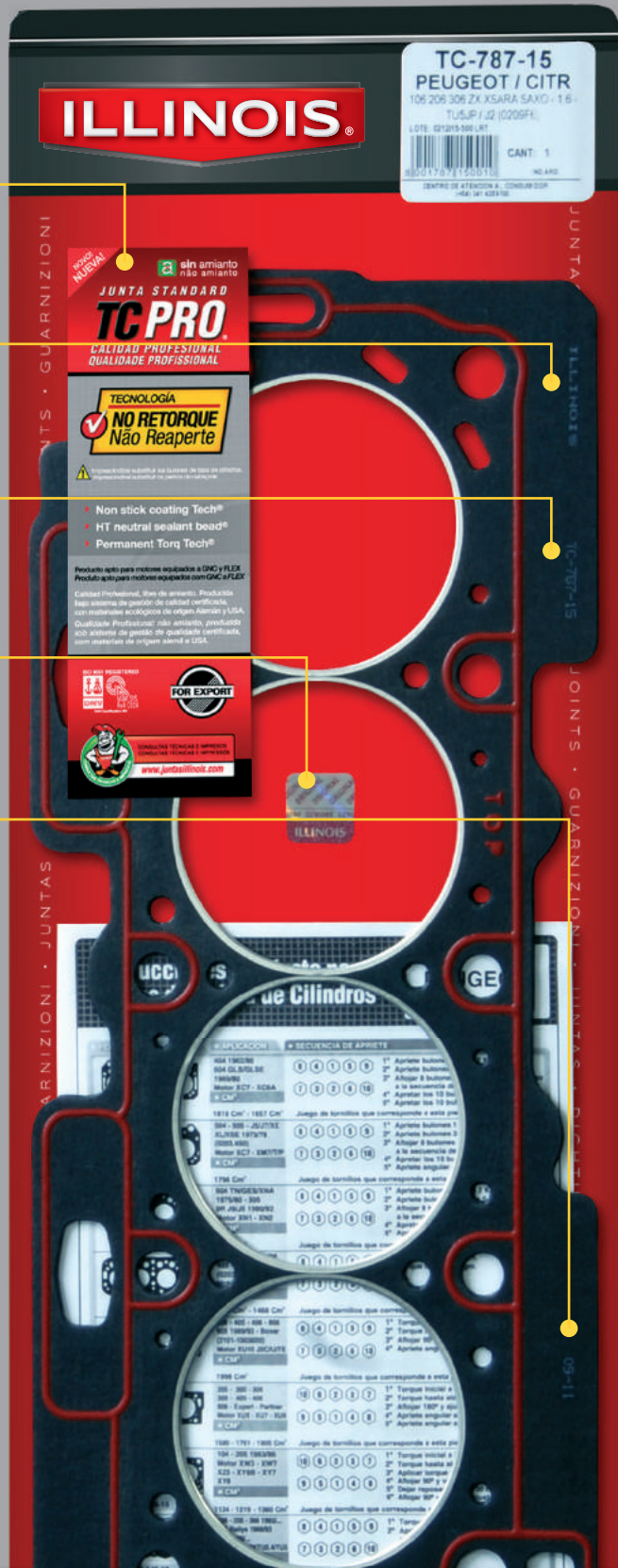

LINE OF SEALANTS AND LIQUID SHAPERS FOR GASKETS

ILLINOIS PRESENTS THE LINE OF SEALANTS AND LIQUID SHAPERS FOR GASKETS.

ILLINOIS sealants and liquid shapers for gaskets do not contain solvents, stay unaffected in the time, and do not contract, crack or harden.

ILLINOIS sealants and liquid shapers offers high-endurance mechanics to vibrations and strokes. They refill defects and scratches, and are suitable to seal conduction elements like water, oils and a great variety of liquids and gases.

One of the main advantages of this product is **its compatibility with non-asbestos materials**. These materials have rubber between their compounds, which are attacked by the traditional gasket glue made with solvents that damage the surface of material and decreases by 70% the resistance to load and pressure.



CONSULTAS TÉCNICAS

info@juntasillinois.com
www.juntasillinois.com



SPECIFIC ENGINE FORMULA

TOP GREY

- ▶ High-Modulus Neutral Curing Sealant
- ▶ RTV Gasket Maker High Temperature



| GRAY |

TOP BLACK

- ▶ High-Modulus Neutral Curing Sealant
- ▶ RTV Gasket Maker High Temperature



| BLACK |

HIGH TEMPERATURE

- ▶ Sealant
- ▶ RTV Gasket Maker High Temperature



| RED |

MULTI-USE

- ▶ Adhesive for multiple uses



| CLEAR |

ESCAPLUS

- ▶ Sealant for Exhaust Systems
- ▶ High Temperature



| BEIGE |

TOP GREY



**High-Modulus Neutral Curing Sealant
RTV Gasket Maker
High Temperature**

Uses:
Intake and exhaust manifolds and seals turbochargers - Gearbox - Valve cover - Oil pan - Water/oil pump - timing cover.
Meets OEM performance requirements and specifications. Do not apply over cylinder head gaskets. Will not damage oxygen sensors.

Endurance to temperatures from -70°C to 280°C, up to 329°C intermittent.



CODE	PRESENTATION	COLOR	PACKING UNIT
2199100	Cartridge 315 gr.	Gray	Pack x 10 units
2199200	Tube 95 gr.	Gray	Pack x 10 units

TOP BLACK



**High-Modulus Neutral Curing Sealant
RTV Gasket Maker High Temperature**

Uses:
Intake and exhaust manifolds and seals turbochargers - Gearbox - Valve cover - Oil pan - Water/oil pump - timing cover. Meets OEM performance requirements and specifications. Do not apply over cylinder head gaskets. Will not damage oxygen sensors.

Endurance to temperatures from -70°C to 280°C, up to 330°C intermittent.



CODE	PRESENTATION	COLOR	PACKING UNIT
2199300	Tube 70 gr.	Black	Pack x 10 units

HIGH TEMPERATURE



**Sealant
RTV Gasket Maker
High Temperature**

Uses:
Valve Cover - Carter - Water pump - Oil pump - Distributor Cap. Endures thermal cycle variations. Wide range of applications in any high temperature area. Do not apply over cylinder head gaskets.

Endurance to temperatures from -65°C to 280°C, up to 320°C intermittent.



CODE	PRESENTATION	COLOR	PACKING UNIT
2099100	Cartridge 280 ml.	Red	Pack x 10 units
2099200	Tube 85 ml.	Red	Pack x 10 units

MULTI-USE



Adhesive Multiple Uses

Uses:
Adhesive for quartering gaskets which are not exposed to extreme temperature conditions. Replaces traditional glue-joint. Adhesive Sealant for soft gaskets, water pump, oil pump, crankcase, timing cover, hose connections, etc.

Endurance to temperatures from -30°C to 150°C.



CODE	PRESENTATION	COLOR	PACKING UNIT
2099300	Cartridge 280 ml.	Clear	Pack x 10 units

ESCAPLUS

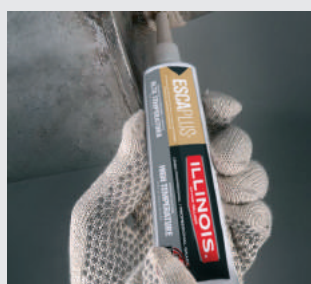

**Sealant for Exhaust Systems
High Temperature**

Uses: Sealant for splices and cracks in the exhaust system and metal parts exposed to high temperatures. Its special components are resistant to the effect of gases and corrosive heat of the exhaust system. It fills imperfections and scratches. Sealant for parts used in the conduction of gases, oils and a variety of liquids.

Endurance to temperatures from -5°C to 900°C, up to 950°C intermittent.



CODE	PRESENTATION	COLOR	PACKING UNIT
2099800	Pot 200 gr.	Beige	Pack x 10 units



ILLINOIS CYLINDER HEAD BOLTS, THE PROFESSIONAL REPAIR



**To fasten correctly,
always replace the
cylinder head bolts.**

Bolts of block and head joints must be systematically replaced after each dismantling. The fastening requirements of the new concepts in engines require the cylinder head bolts to work over the "plastic zone". The strength and traction applied on this selection, together with the thermal deflection, modify the original structure and the properties of the product.



WHY BOLTS SHOULD NOT BE USED AGAIN?

While fastening by Kg., the force applied on the bolt is found within the flexible limits of the product; it means that when the applied force is taken away, the bolt goes back to its initial length. In this case, the bolts do not suffer distortions (deflections), and they could be used again.

Using angular fastening, the bolt goes through considerable strain that leads to plastic deformations (work over the "plastic zone"); meanwhile, the variable temperatures regime of modern engines expands the values of thermal elongation. Stretching within "plastic zone" is accumulative. When working on that section, bolt loses memory of its initial

length when the force is withdrawn when it is dismantled. This is why the reuse becomes impossible, as the fastening capacity does not match the requirements of a proper block-head union. Proper engine repair can only be guaranteed if you're using brand-new bolts.

Would you risk the success of the repair? ILLINOIS strict quality controls guarantee the safety of bolts, according to the technical specifications of each type of engine.



**BOLT
ELONGATION
OVER THE
PLASTIC
ZONE.**



BOLTS MEASUREMENT

Example: **M10** x **1.5** x **117**

1

2

3

1 Measurement of bolt diameter

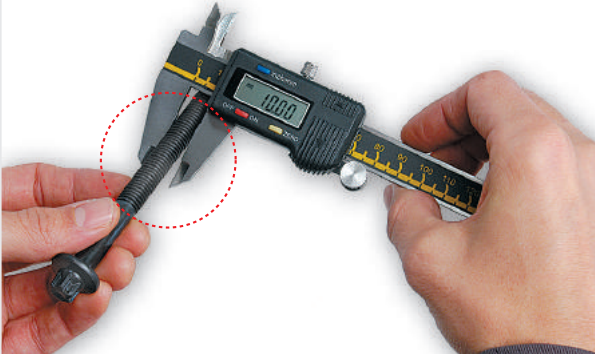



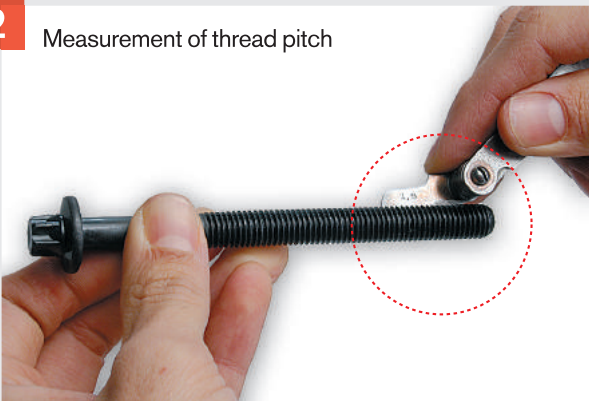



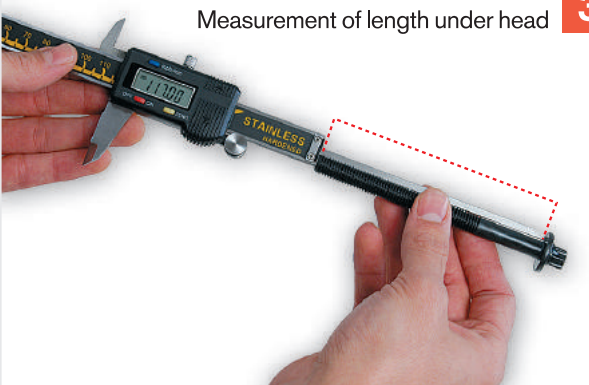















2 Measurement of thread pitch



3 Measurement of length under head



TYPE OF HEADS

-  **HEXAGON**
-  **HEXAGON WITH NECK**
-  **HEXAGON WITH WING**
-  **HEXAGON WITH WING AND NECK**
-  **HEXAGON WITH FLANGE**
-  **COUNTERSUNK HEXAGON**
-  **COUNTERSUNK HEXAGON WITH WING**
-  **COUNTERSUNK SPLINE ROUND**
-  **COUNTERSUNK SPLINE ROUND WITH NECK**
-  **COUNTERSUNK SPLINE ROUND WITH WING**
-  **COUNTERSUNK SPLINE ROUND WITH FLANGE**
-  **COUNTERSUNK TORX**
-  **COUNTERSUNK TORX WITH NECK**
-  **COUNTERSUNK TORX WITH WING**
-  **EXTERNAL TORX WITH WING**
-  **EXTERNAL TORX WITH WING AND NECK**
-  **EXTERNAL TORX WITH FLANGE**
-  **COUNTERSUNK DODECAGON**
-  **COUNTERSUNK DODECAGON WITH NECK**
-  **COUNTERSUNK DODECAGON WITH WING**
-  **COUNTERSUNK DODECAGON WITH FLANGE**
-  **COUNTERSUNK DODECAGON WITH WING**

REMEMBER!!!

For angular fastening, it is essential to change the bolts every time you open the engine.
The consequences of not changing the Cylinder Head Bolts are far more expensive than replacing them.

VERY IMPORTANT!!!

Follow carefully the recommendations in the reports which come together with each of our products, since the evolution in engines, materials and technological changes have left certain procedures and some customary practices out of date and they are no longer valid at present.

ILLINOIS SEALS, LOW FRICTION MAXIMUM DURABILITY

HIGH PERFORMANCE SEALING PRODUCTS

Today, high power engines works with higher compression ratios, and demands top performance designs and materials, developed with specific technology. ILLINOIS seals have been designed to meet these high standards and requirements.



COMPLETE LINES: LIGHT, HEAVY, AGRICULTURA AND INDUSTRY

- ▶ Bank Seal
- ▶ Distribution Seal
- ▶ Camshaft Seal
- ▶ Crankshaft Seal
- ▶ Oil Pump Seal
- ▶ Valve Guide Seal
- ▶ PTFE seal

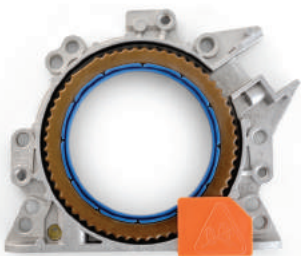

TOP GRADE:

Product tested according to the following international standards, all production is realized under careful quality control throughout the entire manufacturing process. This product has the combination of last generation O.E.M. materials and maximum quality.



MAIN STANDARD DESIGNS (EXTERNAL Ø).

TIPO "L"



Simple designs, conventional application. The main difference is the material of the outer diameter, which can be rubber or metal.

TIPO "M"



The rubber allows to place the piece in a damaged housing, and the metallic exterior will give a firm anchorage, but it will not fill any damage of the housing.

The single or double lip is optional. It depends if the medium is aggressive with the existing contamination.

TIPO "K"



Reinforced structure design offer better protection for the area of the sealing lip.

TIPO "LM"



Combination of designs type L and M.

Our seals offers good anchorage, and seal any possible mark or damage in the housing.

PARTS OF A SEAL

DUST LIP

Avoids contamination of retention lip

OUTER SHEATH

Is the part in contact with housing

RETENTION LIP

Is the part that seals the surface of the moving part.

IDENTIFICATION ENGRAVING

SPRING

Provides a constant tightening between the lip and the shaft.

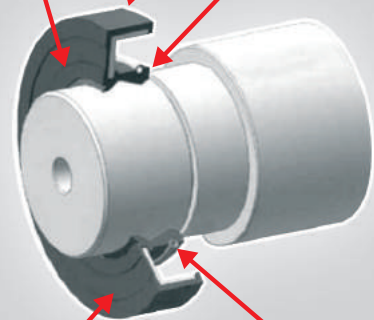

LASTING REPAIR, SATISFIED CUSTOMERS!

- ▶ Great sealing performance
- ▶ High wear resistance
- ▶ Good response to thermal shocks
- ▶ High resistance to different liquid and gas media
- ▶ Ease of assembly
- ▶ Long duration



CONSULTAS TÉCNICAS

info@juntasillinois.com
www.juntasillinois.com

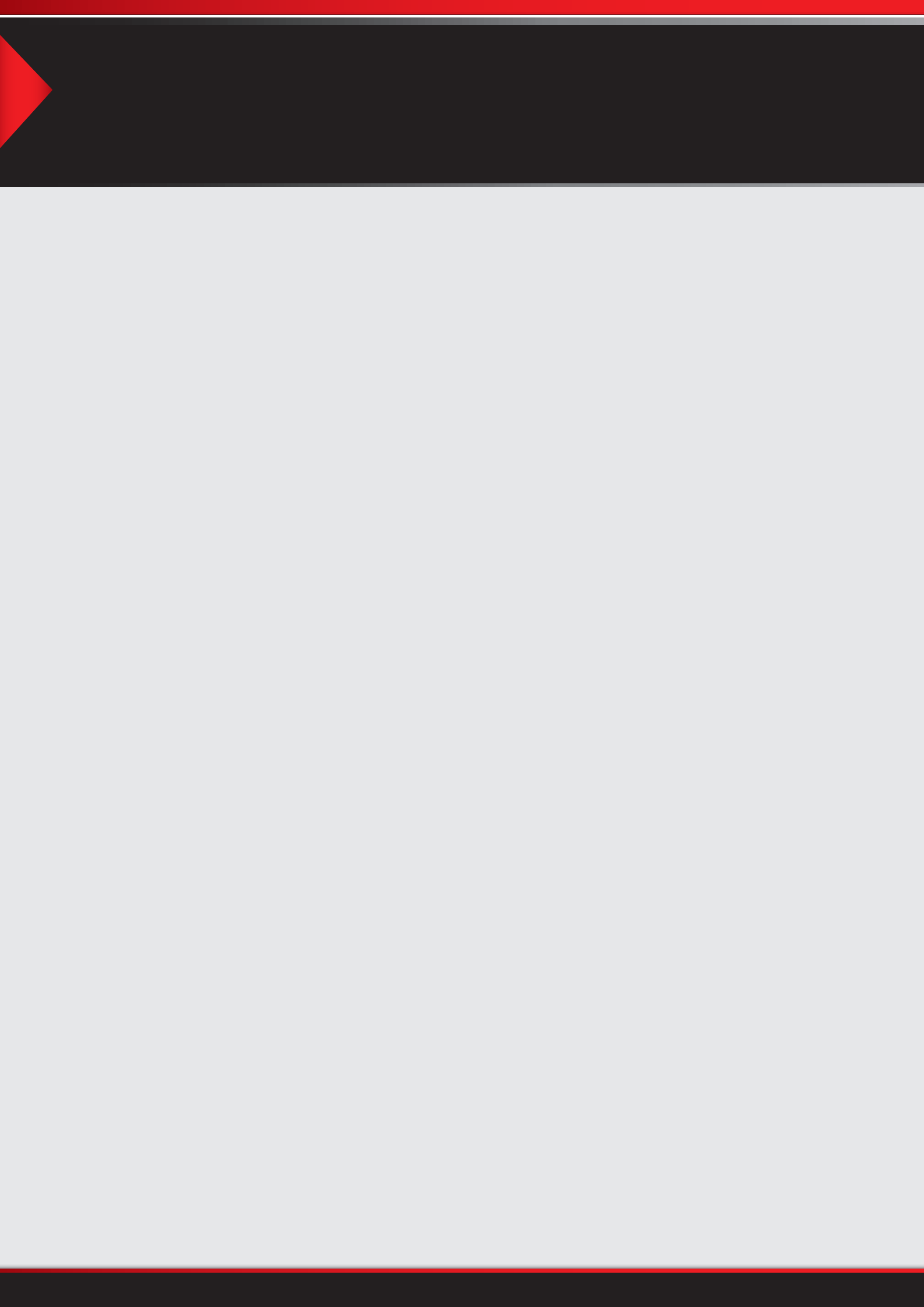

ÍNDICE | ÍNDICE | INDEX

PREFIJO PREFIXO / PREFACE	DESCRIPCIÓN DESCRIÇÃO / DESCRIPTION	PÁGINA PÁGINA / PAGE
	MANEJO DEL CATÁLOGO USO DO CATÁLOGO / HOW TO USE THE CATALOG	L
	FORMACIÓN DE CÓDIGOS FORMAÇÃO DE CÓDIGOS / CODE FORMATION	LII
JR	JUEGO COMPLETO DE REPARACIÓN JOGO DE JUNTAS DO MOTOR / FULL SET GASKETS	01 ~ 388
SJ	SEMI-JUEGO DE REPARACIÓN (SIN TC) SEMI JOGO DE JUNTA (SEM CABEÇOTE) FULL SET GASKETS WITHOUT CYLINDER HEAD	
JD	JUEGO DE DESCARBONIZACIÓN JOGO JUNTAS SUPERIOR / HEAD SET GASKET	
JI	JUEGO INFERIOR JOGO INFERIOR / BOTTOM SET GASKET	
TC	JUNTAS CULATA DE CILINDROS Modelos no incluídos en los juegos completos de reparación JUNTA DE CABEÇOTE - Modelos não incluídos nos jogos do motor CYLINDER HEAD GASKET - Models not included in full set gaskets	389 ~ 414
JV	JUEGO JUNTAS PARA CAJA DE VELOCIDAD JOGO DE JUNTAS PARA CAIXA DE CÂMBIO GEAR BOX SET GASKETS	415 ~ 424
JT	JUEGO JUNTAS PARA TURBO COMPRESOR JOGO DE JUNTAS PARA TURBOCOMPRESSOR TURBO COMPRESSOR SET GASKETS	425 ~ 432
JB	JUEGO JUNTAS PARA CARBURADOR JOGO DE JUNTAS PARA CARBURADOR CARBURETOR SET GASKETS	433 ~ 446
	JUNTAS PARA DIFERENCIAL Y PALIER JUNTAS PARA DIFERENCIAL E PONTA DE EIXO DIFFERENTIAL AND BEARING SET GASKETS	447 ~ 454
	SELLADORES Y FORMADORES DE JUNTA LÍQUIDA SELADORES E FORMADORES DE JUNTA LÍQUIDA SEALANTS AN SHAPERS FOR GASKET	455 ~ 460
BU	TORNILLOS PARA TAPA DE CILINDROS PARAFUSOS DE CABEÇOTE SCREWS FOR CYLINDER HEADS	461 ~ 474
	INFORMACIÓN TÉCNICA INFORMAÇÃO TÉCNICA / TECHNICAL INFORMATION	475 ~ 487

MANEJO DEL CATÁLOGO

USO DO CATÁLOGO

HOW TO USE THE CATALOG

ESP Juntas Illinois presenta su nuevo Catálogo de Productos N°11, una guía completa con más de 11.600 referencias entre juntas, retenes, tornillos y selladores. La información se encuentra organizada por marca de vehículo en forma alfabética y en orden ascendente de cilindrada. En la sección final del catálogo, se incluye información técnica específica para la correcta utilización de nuestros productos. Toda la información, especificaciones e ilustraciones contenidas en el presente catálogo son vigentes en el momento de la impresión. Juntas Illinois se reserva el derecho de cambiar o modificar características, materiales y especificaciones técnicas de los productos, sin previo aviso, con el fin de añadir actualizaciones.

PORT Juntas Illinois apresenta seu novo Catálogo de Produtos N°11, um guia completo com mais de 11.600 referências entre juntas, retentores, parafusos e seladoras. A informação está organizada por marca de veículo, em ordem alfabética e em ordem ascendente de cilindrada. Na seção final do catálogo, encontra-se a informação técnica específica para a utilização correta dos nossos produtos. Todas as informações, especificações e ilustrações contidas no presente catálogo estão vigentes no momento da impressão. Juntas Illinois se reserva o direito de alterar ou modificar características, materiais e especificações técnicas dos produtos, sem aviso prévio, com a finalidade de acrescentar atualizações.

ENG Juntas Illinois presents its new Products Catalog N°11, a complete guide with more than 11.600 references for gaskets, oil seals, screws and sealants. The information is organized in alphabetical order according to the car make and also in ascending order for cylinder capacity. In the last section of the Catalog, there's specific technical information for the correct use of our products. All the information, specifications and drawings presented in this Catalog are valid up to the moment it was printed. In order to keep the material updated, Juntas Illinois reserves the right to change or modify characteristics, materials and technical specifications of the products without prior notice.

INDICE		ÍNDICE / INDEX		MOTOR / ENGINE		HP	Ø Pist.	PAG.
JUEGOS DE MOTOR (JR-SJ-JD) Juego Completo de Reparación / Full Set Gaskets								
<i>Ordenado por cm³ / Ordenados pelo cm³ / Arranged by cm³</i>								
ALFA ROMEO								
REF.	MODELO / MODEL	CM ³	MOTOR / ENGINE	HP	Ø Pist.	PAG.		
SJ-246	145/146 - 155 TD 1993/99 - FIAT: FIORINO - UNO - TIPO - PALIO - DUNA - TEMPRA REGATA - DOCTO - SIENA TD - LANCIA: DELTA - DEDRA 1994/99	1697cc. 1697cc. 1929cc. 1929cc.	149B 176A 1900-2600T 675.01-336.01	58 69/71 68 90	82.80 82.80	108		
JR-354-15	155 TURBO 16V - CROMA IE 16V 1990/96 - COUPE IE 16V - FIAT: TEMPRA IE 16V TIPO IE 16V - LANCIA: DELTA INTEGRALE 1986/92 - THEMA TURBO 16V - DEDRA IE - KAPPA (7078950)	1756cc. 1995cc. 1995cc. 1995cc.	160 A5000 898 A3000/11 834 C23492 159E1900/27/160A896	138 142 180 140/145	84.00 84.00 84.00	110		
SJ-230	90/75TD 1983/... - 155/164TD 1983/... - FORD: SCORPIO TDI - GRANADA TDI FALCON 1988/... - BORGWARD: VM TURBO - ROVER: RANGE ROVER TD 1986/89	2393cc. 2499cc.	HR 482 - 484 TD	95 110/113 114/125	88.00 92.00 92.00	23		
AUDI								
REF.	MODELO / MODEL	CM ³	MOTOR / ENGINE	HP	Ø Pist.	PAG.		
JR-302-15	4000 - 80 - 4E - 100 - VOLKSWAGEN: FOX 1979/83 - COUPE 1980/81 - CADDY PASSAT - JETTA - SANTANA - VAN - GOLF - GOL - GACEL 1975/84 - POINTER - LUPO	1508cc. 1508cc. 1508cc. 1588cc.	YH/YH/YH/YH/YH VY/V2/YH/YH DMF3/FF/FM/FM FW/WY/WY/WV	110 73/85 75/110 75/110	79.50 79.50 79.50	321		
SJ-242	80 DTD 1981/85 - VOLKSWAGEN: SENDA - SAVEIRO - GOL - CADDY - GOLF - PASSAT KOMBI - SANTANA	1588cc.	CR/JK/DR/JFC/5	54/70	76.50	322		
SJ-271	80 D 1989/91 - 80 TD 1991/95 - VOLKSWAGEN: POLO - GOLF - CADDY - PASSAT TRANSPORTER T - 1990/92 - SINCR0 - CARAVELLE - SEAT: IBIZA - TOLEDO CORDOBA 1991/95	1806cc. 1806cc.	1Y - AAZ 1X	64/75 61	79.50 79.50	324		
BEDFORD								
REF.	MODELO / MODEL	CM ³	MOTOR / ENGINE	HP	Ø Pist.	PAG.		
JR-104	J6 1961/71 - 300D 1962/67 6 CILINDROS	4927cc.	300D	97	98.30	21		
BELARUS								
REF.	MODELO / MODEL	CM ³	MOTOR / ENGINE	HP	Ø Pist.	PAG.		
JR-246-20	MTZ 850 TRACTOR 1966/... 4 CILINDROS	4850cc.	MTZ 80	90		22		
BORGWARD								
REF.	MODELO / MODEL	CM ³	MOTOR / ENGINE	HP	Ø Pist.	PAG.		
SJ-230	VM TURBO - ALFA ROMEO: 90/75TD 1983/... - 155/164TD 1983/... - FORD: SCORPIO TDI - GRANADA TDI - FALCON 1988/... - ROVER: RANGE ROVER TD 1986/89	1995cc. 2393cc. 2499cc.	HR 482 - 484 TD	95 110/113 114/125	88.00 92.00 92.00	23		
CASE								
REF.	MODELO / MODEL	CM ³	MOTOR / ENGINE	HP	Ø Pist.	PAG.		
JR-195-20	580H - HYSTER H110 - M. FERGUSON: 85X - 220 - 230 - 235 - 270 - 275 - 290 PERKINS: 4-236 - 4-248 AGRICOLA ID - P4.248	4070cc.	A 4-248	75	100.00	232		
CHEVROLET / OPEL								
REF.	MODELO / MODEL	CM ³	MOTOR / ENGINE	HP	Ø Pist.	PAG.		
JR-507-15	SPRINT - SUZUKI: SWIFT - CULTUS - VAN TURBO 1984/... (1140082810/14)	993cc.	61-G10-G10T	50	74.00	24		
JR-508-15	SPARK - 724 - DAEWOO: MATIZ II - KALOS 2000/...	995cc. 1148cc.	B10S F12S3	63 71	68.50 68.50	25		
JR-478-15	CORSA - COMBO - DELTA 1990/... - TIGRA EFI MPFI - B10 NZ 1994/...	996cc. 1196cc. 1196cc. 1196cc.	DHC 12NZ X12SZ	45 45 45	71.10 72.00 72.00	26		
JR-521-15	CELTA 2000/... - CLASSIC - SUZUKI: FUN 2002/...	999cc.	C10NE MPFI BV (SOCH)	60	71.10	27		
JR-522-15	CORSA 16V DOCH 1998/...	999cc.	MPFI	68	71.00	28		
JR-373-15	CORSA GL EFI - KADETT E 1986/91 - CAVALIER 1986/94 - CHEVY - ASCONA C 1986/88 - ASTRA 1986/93 - VECTRA A	1309cc. 1309cc.	C14NZ/NV OHV	60/75	77.80 77.80	29		
JR-540-15	CORSA A/B 1991/97 - COMBO 1983/... - SWING 1984/98 - CHEVY POPULAR 1985/... - ASTRA 1998/98 - DELTA MPFI 2004/... - CORSA - MONTANA ECOFLEX 2007/...	1389cc. 1389cc.	C14E - X14NZ L05	60/82 85/97	77.80 77.80	30		
JR-335-15	CHEVETTE 1973/80 (7329442/06622306) - GM	1393cc. 1599cc.	GMC 85 GMC 98	45 71	82 82	31		
JR-374-15	CORSA GL MPFI - KADETT E 1986/93 - ASTRA 1986/93 - CAVALIER 1986/94 - ASCONA C 1986/88 - VECTRA A - DAEWOO: CIELO - ESPEIRO - LEMANS - RACER 99/97 - NEXIA (93245869)	1498cc. 1598cc. 1598cc. 1598cc.	G15MF OHV E16SE/NE/NZ C16LZ/NZ/SV	75/78 75 79/80/111 75/82	76.50 79.00 79.00 79.00	32		

Como usar el catálogo de productos Illinois:
Como usar o catálogo de produtos Illinois:
How to use the Illinois Products Catalog:

- A** Ubique la marca del vehículo deseada.
Localize a marca do veículo desejada.
Find the car make you are interested in.
- B** Identifique la cilindrada.
Identifique a cilindrada.
Identify the cylinder capacity.
- C** Seleccione el modelo del vehículo deseado.
Selecione o modelo do veículo desejado.
Select the car model you are interested in.
- D** Verifique las características técnicas del motor.
Verifique as características técnicas do motor.
Check the engine's technical characteristics.
- E** Ubique la página correspondiente de su ubicación en el catálogo.
Localize a página correspondente no catálogo.
Find the correct page in the Catalog.
- F** Ver páginas siguientes.
Ver páginas seguintes.
See following pages

ESP Código de identificación:

JR (jgo. de motor) **382** (nº correlativo) **15** (material de fabricación de la junta culata)
IMPORTANTE: Si en el código de identificación de un **Jgo. de Motor (JR)** se omite el material de fabricación (Ej. JR-190), implica que existen varias alternativas de configuración para ese modelo. En este caso Ud. debe determinar el material de la junta de culata de cilindros en función a los materiales disponibles informados en el apartado: "JUNTA CULATA DE CILINDROS".

PORT Código de identificação:

JR (jogo de motor) **382** (nº referência) **15** (material de fabricação do cabeçote)
IMPORTANTE: caso o código de identificação de um **jogo de Motor (JR)** omite o material de fabricação (Ex: JR-190), significa que existem várias alternativas de configuração para este modelo. Neste caso, você deve determinar o material da junta do cabeçote em função dos materiais disponíveis informados no parágrafo correspondente: "JUNTA DE CABEÇOTE".

ENG Identification code:

JR (engine set) **382** (correlative number) **15** (head gasket material)
IMPORTANT: If the identification code of an **engine set (JR)** omits the material (E.g: JR-190), it means that there exist various configuration alternatives for that model. In that case, you should determine the material of the cylinder head gaskets based on the available materials that were informed in the section: "CYLINDER HEAD GASKET"

OPCIONAL Retenes:

Para solicitar el Juego de Motor con sus correspondientes retenes, debe agregar al final del código la letra "R". Ej. JR-382-15 R

OPCIONAL Retenores:

Para pedir o Jogo de Motor com seus retenores correspondentes, você deve acrescentar ao final do código a letra "R". Ex: JR-382-15 R.

OPTIONAL Oil seals:

In order to request an Engine Set with its oil seal, you should add to the final code the letter "R". For example: JR-382-15 R.

Opciones alternativas para la configuración de juegos.

Opções alternativas para configuração de jogos.

Alternative options for set configuration.

Diámetro boca cilindro junta culata.

Diâmetro boca cilindro junta cabeçote.

Cylinder mouth diameter of the head gasket.

Espesor junta culata.

Espessura junta do cabeçote.

Thickness of the head gasket.

Modelo de motor.

Modelo do motor.

Engine model.

Juego de Descarbonización.

Jogo de Retífica.

Head Set Gasket.

Características técnicas del motor.

Características técnicas do motor.

Technical characteristics of the engine.

Opcional Retenes.

Opcional Retenores.

Opcional Oil Seals.

Productos relacionados no incluidos en el juego. Los mismos pueden ser solicitados por separado.

Produtos relacionados não incluídos no jogo. Podem ser solicitados em separado.

Related products that were not included in the set but can be ordered separately.

Juego Completo de Reparación: Jogo de Juntas de Motor / Full Set Gasket:		JR-382-15	R	DESCRIPCIÓN / Descrição / Description			
Semi-Juego de Reparación: Semi-Jogo de Juntas / Semi-Set Gasket:		SJ-382	R	FIAT: Palio - Siena - Tipo 1.6 - Bravo - Marea Torque 16V - Strada - Brava - Multipla 1999/... LANCIA: Delta - Dedra - Lybra 1996/...			
Juego de Descarbonización: Jogo de Juntas Superior / Head Set Gasket:		JD-382-15	R	MOTOR / Engine	CM ³	HP	Ø PISTON
JUNTA CULATA DE CILINDROS	TC-618-15	67,00mm	1,60mm	182A4	1581	103	86,40
Junta de cabeçote				182A6	1581	90/103	86,40
Cylinder Head gasket				185A3	1581	103	86,40
				186A4	1581	103	86,40

JD-382-15	TC-618-15 - 46410960 Junta Culata de Cilindros	2743100 - 46402220 Juego toberas admisión	1192400 Mariposa aire tapa	1192100 - 4179138 Base bomba de aceite
JAE-433-A - 46410505 Junta Admisión	JAE-432-E - 46412116 Junta Escape	2704100 O'ring 55,25 x 2,62mm	2704200 - 46428901 O'ring 59,92 x 3,53mm	
JVS-291-15 - 7773831 Junta Tapa Válvula Superior	1029300 - 4179043/7737203 Tapa distribución	JSA-188-11 - 4309031 Salida Escape	RT-565Pol Juego Retenes Guía de Válvulas	
JC-326-26 - 7663366/4179038 Junta Cáter	1030500 - 4195119/7737204 Porta retén distribución	1192500 Tapa bomba de aceite	RT-6121Pol Retén Árbol de Levas Mx-R 30,00 x 52,00 x 7,00	
1192200 - 4902267 Porta retén	1192300 - 7770023 Pasaje de agua a tapa	2727400 - Juego Arandelas de Goma		

Gráfico	Descripción	Cantidad
○	O'ring 89,57x2,62mm	1
○	O'ring 66,27x3,53mm	1
○	O'ring 50,39x3,53mm	1
○	O'ring 31,34x3,53mm	1
○	O'ring 28,57x3,53mm	1
○	O'ring 18,72x2,62mm 7792371	1
○	O'ring 17,12x2,62mm 7792369	1
○	O'ring 6,07x1,78mm	1

BU-008 Bulones para Culata de Cilindros	JB-251-INY Juego Carburador	RT-2872VIT Porta retén bancada	JSA-188-17 - 4309031 Salida Escape
---	---------------------------------------	--	--

Productos relacionados no incluídos en el juego. Los mismos pueden ser solicitados por separado.
 Produtos relacionados não incluídos no jogo. Podem ser solicitados em separado.
 Related products that were not included in the set but can be ordered separately.

FORMACIÓN DE CÓDIGOS FORMAÇÃO DE CÓDIGOS CODE FORMATION

CÓDIGO / CÓDIGO / CODE

ESP PREFIJO: Referencia la línea de producto.

PORT PREFIXO: Referência da linha de produto.

ENG PREFACE: Reference to product lining.

TC - 649 - 15

▶ N° ILLINOIS: Numeración correlativa interna.

▶ N° ILLINOIS: Numeração correspondente interna.

▶ N° ILLINOIS: Internal correlative numeration.

▶ MATERIAL: Indica el material con que se encuentra confeccionada la pieza.

▶ MATERIAL: Indica o material com o qual a peça é confeccionada.

▶ MATERIAL: It shows the part's material.

PREFIJS / PREFIXOS / PREFACES

CÓDIGOS DE MATERIALES / CÓDIGOS DE MATERIAIS MATERIAL CODES

TC	JUNTA CULATA DE CILINDROS <i>Junta de cabeçote / Cylinder head gasket</i>	MG	METALGRAF® TECNOLOGIA SUSTITUTA A LA JUNTA MULTILAMINA (MLS) <i>Metalgraf® tecnologia substituta da junta multilamina (mls) / Metalgraf® substitute technology to the multilayer joint (mls)</i>
JR	JUEGO COMPLETO DE REPARACION <i>Jogo de Juntas do Motor / Full set gaskets</i>	01	COBRE, AISLANTE TERMICO ALTA COMPRESION Y COBRE <i>Cobre, isolante térmico de alta compressão e cobre / Copper, thermal insulation with high compression resistance and copper.</i>
SJ	JUEGO COMPLETO "sin TC" (SEMI-JUEGO) <i>Jogo de Juntas de Motor "sem TC" (semijogos) / Full set gaskets without cylinder head</i>	02	DOS CARAS DE COBRE, DOS DE AISLANTE TERMICO ALTA COMPRESION E INSERTO METALICO EN EL CENTRO <i>Dois faces de cobre, duas de isolante térmico alta compressão com malha metálica no centro / Two copper sheets, two thermal insulation sheets high compression and metal insert in the middle</i>
JD	JUEGO DE DESCARBONIZACION <i>Jogo de Juntas Superior / Head set gasket</i>	03	HOJALATA, AISLANTE TERMICO ALTA COMPRESION Y COBRE <i>Latão, isolante térmico alta compressão e cobre / Tinplate, thermal insulation with high compression resistance and copper.</i>
JI	JUEGO JUNTAS INFERIOR <i>Jogo de Juntas Inferior / Bottom set gasket</i>	04	AISLANTE TERMICO ALTA COMPRESION (ORIGEN USA) CON INSERCION METALICA Y FONDO DE COBRE <i>Isolante térmico alta compressão (origem USA) com malha metálica e fundo de cobre / Thermal insulation with high compression resistance (made in the USA) with metal insertion and a bottom copper plate</i>
JAE	JUEGO ADMISION Y ESCAPE <i>Jogo de Admissão e Escape / Intake and exhaust manifolds gaskets</i>	05	AISLANTE TERMICO ALTA COMPRESION (ORIGEN USA) CON INSERCION METALICA Y FONDO DE HOJALATA <i>Isolante térmico alta compressão (origem USA) com malha metálica e fundo de latão / Thermal insulation with high compression resistance (made in the USA) with metal insertion and a bottom tinplate.</i>
JSA	JUNTA SALIDA ESCAPE <i>Junta Saída de Escape / Exhaust pipe seals gaskets</i>	06	AISLANTE TERMICO CON INSERCION METALICA (NACIONAL) <i>Isolante térmico (nacional) com inserção metálica / Thermal insulation (national) with metal insertion</i>
JC	JUNTA PARA CARTER <i>Junta para Cártier / Oil pan gaskets</i>	07	AISLANTE TERMICO CON INSERCION METALICA (ORIGEN ASIATICO) <i>Isolante térmico (origem asiática) com inserção metálica / Thermal insulation (made in asia) with metal insertion.</i>
JVS	JUNTA TAPA DE VALVULA (SUPERIOR) <i>Junta Tampa de Válvulas (superior) / Valve gaskets (superior)</i>	09	HOJALATA, AISLANTE TERMICO ALTA COMPRESION Y HOJALATA <i>Latão, isolante térmico alta compressão e latão / Tinplate, thermal insulation with high compression resistance and tinplate</i>
JVL	JUNTA TAPA DE VALVULA (LATERAL) <i>Junta Tampa de Válvulas (lateral) / Valve gaskets (lateral)</i>	11	MULTILAMINA (MLS) <i>Multilamina / Multilayer</i>
JV	JGO. JUNTAS PARA CAJA DE VELOCIDAD <i>Jogo de Juntas para Caixa de Câmbio / Gear box set gaskets</i>	12	LAMINAS DE COBRE <i>Lâminas de cobre / Copper sheets</i>
JB	JGO. JUNTAS PARA CARBURADOR <i>Jogo de Juntas para Carburador / Carburetor set gaskets</i>	15	AISLANTE TERMICO DE ALTA COMPRESION "TC PRO®" NAFTA CON INSERCION METALICA (ORIGEN USA) <i>Isolante térmico de alta compressão "TC PRO®" gasolina/álcool (origem USA) com inserção metálica / Thermal insulation with high compression "TC PRO®" gas (made in the USA) with metal insertion</i>
JCA	JGO. JUNTAS PARA COMPRESOR <i>Jogo de Juntas de Compresor de ar / Compressor set gaskets</i>	16	ACERO INOXIDABLE <i>Aço inoxidável / Stainless steel</i>
JT	JGO. JUNTAS PARA TURBO COMPRESOR <i>Jogo de Juntas para Turbo Compresor (Turbina) / Turbo compressor set gaskets</i>	17	ACERO LAMINADO <i>Aço laminado / Rolled steel</i>
BU	TORNILLOS PARA CULATA DE CILINDROS <i>Parafusos de cabeçote / Cylinder head bolts</i>	18	AISLANTE TERMICO ALTA COMPRESION DE 2,5 MM. "SUPERMEDIDA" CON INSERCION METALICA <i>Isolante térmico alta compressão de 2,5mm. "Supermedida" com inserção metálica / Thermal insulation with high compression resistance of 2,5mm. "Supermedida" with metal insertion</i>
RT	RETENES <i>Retentor / Oil seals</i>	19	BRONCE <i>Bronze / Bronze</i>
		20	AISLANTE TERMICO DE ALTA COMPRESION "TC PRO®" DIESEL CON INSERCION METALICA (ORIGEN USA) <i>Isolante térmico de alta compressão "TC PRO®" diesel (origem usa) com inserção metálica / Thermal insulation with high compression resistance "TC PRO®" diesel (made in the usa) with metal insertion</i>
		21	ANILLO MALLA ACERO <i>Anel de malha de aço / Steel mesh ring</i>
		22	FUNDICION <i>Fundição / Foundry</i>
		23	CORGOM CON REFUERZO DE MATERIAL COMPRIMIDO <i>Cordão com reforço de material comprimido / Cork + rubber with reinforcement of compressed material</i>
		28	MATERIAL COMPRIMIDO (Resinas - Cauchos - Celulosa) DE 0,20 MM. <i>Material comprimido (resinas - látex - celulose) de 0,20 mm / Compressed material of 0,20 mm (resins- rubber- cellulose)</i>
		29	MATERIAL COMPRIMIDO (Resinas - Cauchos - Celulosa) DE 0,30 MM. <i>Material comprimido (resinas - látex - celulose) de 0,30 mm / Compressed material of 0,30 mm (resins- rubber- cellulose)</i>
		24	MATERIAL COMPRIMIDO (Resinas - Cauchos - Celulosa) DE 0,50 MM. <i>Material comprimido (resinas - látex - celulose) de 0,50 mm / Compressed material of 0,50 mm (resins- rubber- cellulose)</i>
		34	MATERIAL COMPRIMIDO (Resinas - Cauchos - Celulosa) DE 0,80 MM. <i>Material comprimido (resinas - látex - celulose) de 0,80 mm / Compressed material of 0,80 mm (resins- rubber- cellulose)</i>
		25	MATERIAL COMPRIMIDO (Resinas - Cauchos - Celulosa) DE 1,00 MM. <i>Material comprimido (resinas - látex - celulose) de 1,00 mm / Compressed material of 1,00 mm (resins- rubber- cellulose)</i>
		26	MATERIAL COMPRIMIDO (Resinas - Cauchos - Celulosa) DE 1,50 MM. <i>Material comprimido (resinas - látex - celulose) de 1,50 mm / Compressed material of 1,50 mm (resins- rubber- cellulose)</i>
		27	MATERIAL COMPRIMIDO (Resinas - Cauchos - Celulosa) DE 2,40 MM. <i>Material comprimido (resinas - látex - celulose) de 2,40 mm / Compressed material of 2,40 mm (resins- rubber- cellulose)</i>
		30	CORGOM: CORCHO Y GOMA (VARIOS ESPESORES) <i>Corgom: cortiça e borracha (várias espessuras) / Corgom: cork and rubber (various thicknesses)</i>
		31	CORGOM DE 3 MM. <i>Corgom de 3 mm / 3 mm corgom</i>
		32	CORGOM DE 5 MM. <i>Corgom de 5 mm / 5 mm corgom</i>
		43	GOMA SINTETICA <i>Borracha sintética / Synthetic rubber</i>
		46	SILICONA <i>Silicone / Silicone</i>
		47	VITON <i>Viton / Viton</i>

IMPORTANTE

Los números originales indicados en esta lista son publicados a modo informativo. En sus pedidos, sírvase utilizar los códigos ILLINOIS.
 Importante !!! Os números originais indicados neste catálogo são publicados com fins informativos. Em seus pedidos favor utilizar os códigos Illinois.
 Important !!! Original part numbers indicated in this catalog are published to inform. In your order forms, please indicate only ILLINOIS referens numbers.

ILLINOIS®

JUEGO COMPLETO DE REPARACIÓN

SEMI-JUEGO DE REPARACIÓN (Sin TC) JUEGO DE DESCARBONIZACIÓN

ESP

JOGO DE JUNTAS DO MOTOR

SEMI JOGO (sem cabeçote) JOGO DE JUNTAS SUPERIOR

PORT

FULL SET GASKET

FULL SET GASKET WITHOUT CYLINDER HEAD HEAD SET GASKET

ENG

JR SJ
JD

Tenemos 75 años
de historia

Temos 75 anos de história

WE GOT 75 YEARS OF HISTORY

y también
de tecnología

e também de tecnologia

AND ALSO OF TECHNOLOGY



ILLINOIS. MÁS DE 11.600 PRODUCTOS PARA EL SELLADO DE MOTORES DE TODAS LAS ÉPOCAS.

ILLINOIS. MAIS DE 11.600 PRODUTOS PARA A VEDAÇÃO DE MOTORES DE TODAS AS ÉPOCAS / MORE THAN 11.000 PRODUCTS FOR THE SEALING OF ALL-TIME ENGINES.



ILLINOIS

JUEGOS DE MOTOR (JR-SJ-JD) Jogo de Juntas do Motor / Full Set Gasket

Ordenado por cm³ / Ordenados pelo cm³
Arranged by cm³

AGRALE							
REF.	MODELO / MODEL		Cm ³	MOTOR / ENGINE	HP	Ø Pist.	PAG.
SJ-347	AGRALE: TD (MICRO-ÔMNIBUS) 2000/... - 6000 - FURGON VAN CHEVROLET: S10 TD - BLAZER TD 2000/... - NISSAN: FRONTIER - X TERRA TD 12V VOLARE: A5 - A6 - A8 - VOLKSWAGEN: LTDI 1997/...	Diesel	2796cc.	AGK	125	93.00	228
			2796cc.	ATA	131	93.00	
			2796cc.	Sprint 4.07 TCA	132	93.00	
JR-329-20	TRACTOR 5075.4 - 5085.4/5 - BX6110 - 88 - FIAT: EXCAVADORA FB80 FORD: F100 1993/95 - F1000 1994/96 F4000 1992/93 - F2000 1980/... FB4000 1985/... - VALMET: 78/88/880/980 4X4 - VOLKSWAGEN: 6.90/7.90/7.110 (922900134317/1997/3237/2338)	Diesel	3922cc.	D229-4	96	102.00	229

ALFA ROMEO							
REF.	MODELO / MODEL		Cm ³	MOTOR / ENGINE	HP	Ø Pist.	PAG.
JR-559	159 2005/... - CHEVROLET: Cruze 1.8 2008/... - Aveo 1.4 2009/... FIAT: Croma 2005/... - OPEL: Astra H 2004/... - Signum Vectra C 2006/... Zafira B 2005/... - Insignia 2008/...		1399cc.	F14D4 (DOHC 16V)	101	80.50	52
			1796cc.	F18D4 (DOHC 16V)	141	80.50	
			1796cc.	Z18XER/A18XER	141	80.50	
			1796cc.	939A4 (DOHC 16V)	140	80.50	
SJ-246	145/146 - 155 TD 1993/99 - FIAT: FIORINO - DUCATO - UNO - TIPO - PALIO - DUNA TEMPRA - REGATTA - SIENA TD - LANCIA: DELTA - DEDRA 1994/99	Diesel	1697cc.	149B	58	82.60	125
			1697cc.	176A	69/71	82.60	
			1929cc.	160D-280A1	65	82.60	
			1929cc.	675.01-336.01	90	82.60	
JR-354-15	155 TURBO 16V - FIAT: TEMPRA IE 16V - TIPO IE 16V - CROMA IE 16V 1990/96 COUPE IE 16V - LANCIA: DELTA INTEGRALE 1986/92 - THEMA TURBO 16V DEDRA IE - KAPPA (7076950)		1756cc.	160 A5000	138	84.00	127
			1995cc.	836 A3000/11	142	84.00	
			1995cc.	834 C1246/2 - Zact 16V	126/145/180	84.00	
			1995cc.	154E1000/27/160A8046	140/145	84.00	
SJ-230	75/90TD 1983/... - 155/164TD 1993/... - BORGWARD: VM TURBO CHRYSLER: VOYAGER - GRAND VOYAGER 1992/94 - FORD: SCORPIO TDI GRANADA TDI FALCON 1988/... - ROVER: RANGE ROVER TD 1986/89 TOYOTA: LANDCRUISER 70/250 TD 1987/93	Diesel	1995cc.	VM80A	95	88.00	27
			2393cc.	HR 492	110/113	92.00	
			2499cc.	494 TD / HR425	114/125	92.00	

ASIA							
REF.	MODELO / MODEL		Cm ³	MOTOR / ENGINE	HP	Ø Pist.	PAG.
JR-347-15	TOWNER 1993/2002		843cc.	CD	40/45	70.00	25
JR-348-20	TOPIC - HI TOPIC 1993/... (K61210271)	Diesel	2701cc.	SS	69/75	96.00	26

AUDI							
REF.	MODELO / MODEL		Cm ³	MOTOR / ENGINE	HP	Ø Pist.	PAG.
JR-302-15	4000 - 80 - 4E - 100 - VOLKSWAGEN: CADDY - VAN - COUPE 1980/81 - PASSAT JETTA - SANTANA - GOLF - GOL - GACEL 1975/84 - POINTER - LUPO - FOX 1979/83		1588cc.	YN/YP/YH/YT/YS	110	79.50	371
			1588cc.	VY/VZ/YW/YN	75/85	79.50	
			1588cc.	EM/FS/FT/FR/FN	75/110	79.50	
			1588cc.	FP/WP/WY/WV	75/110	79.50	
SJ-242	80 D/TD 1981/85 - VOLKSWAGEN: SENDA - SAVEIRO - GOL - CADDY - GOLF PASSAT - KOMBI - SANTANA 1981/86 - JETTA	Diesel	1588cc.	CR/JK/DR/JF/C5	54/70	76.50	372
JR-475-15	A3 1996/... - SEAT: TOLEDO - CORDOBA 2001/05 - IBIZA 2001/03 - LEON 1999/... SKODA: OCTAVIA 1997/... - VOLKSWAGEN: GOLF 1997/... - POLO 1999/... BORA 1998/... - PASSAT 1996/... - NEW BEETLE		1595cc.	AKL/AHL/ANA/AYD	100	81.00	373
			1595cc.	ARM/AEH/APF/AVU	100	81.00	
JR-414-15	A4 - A4 TURBO 94/... - A6 - A6 TURBO 95/... - CABRIO 1997/... - A6 QUATTRO 1999/... - VOLKSWAGEN: PASSAT 1996/... - PASSAT TURBO 1996/98		1781cc.	AFY/ADR	115/125	81.00	377
			1781cc.	AEB/AJL/ANB	150/180	81.00	
JR-517-15	A3 - A3 QUATTRO 1998/... - A6 1997/... - A3 TURBO 1996/... - SEAT: ALHAMBRA LEON TURBO 1996/... - VOLKSWAGEN: GOLF - SHARAN 1997/... - BORA 2000/... NEW BEETLE - PASSAT TURBO 1999/...		1781cc.	AJP	125	81.00	378
			1781cc.	AGU/AJH/ARZ	150	81.00	
			1781cc.	AJQ/APP	180	81.00	
JR-826-11	A3 - A4 - A5 - Q5 - TT TFSI - SEAT: LEON TSI 2007/12 - VOLKSWAGEN: GOLF VI - JETTA - PASSAT FSI/TSI - SCIROCCO - SHARAN TSI TIGUAN - VENTO TFSI		1798cc.	CDA/CDAB	160/152	82.50	379
			1984cc.	CAEA/CAEB/CAWA/CAWB	170/200	82.50	
			1984cc.	CCTA/CCTB/CCZA/CCZB	170/200	82.50	
			1984cc.	CBFA/CCZC/CDNB/CDNC	170/200	82.50	
SJ-271	80 D 1989/91 - 80 TD 1991/95 - VOLKSWAGEN: CADDY - TRANSPORTER T.4 1990/92 - POLO - GOLF - PASSAT - SYNCRO - CARAVELLE - SEAT: IBIZA TOLEDO - CORDOBA 1991/93	Diesel	1896cc.	1Y - AAZ	64/75	79.50	380
			1896cc.	1X	61	79.50	
SJ-336	A3 TDI 1996/99 - SKODA: OCTAVIA TDI 1996/... VOLKSWAGEN: BORA - GOLF SDI/TDI 1997/...	Diesel	1896cc.	ALH/AHF/AGR	90/110	79.50	381
			1896cc.	AGP/AHF	68/110	79.50	

BORGWARD							
REF.	MODELO / MODEL		Cm ³	MOTOR / ENGINE	HP	Ø Pist.	PAG.
SJ-230	VM TURBO - ALFA ROMEO: 75/90TD 1983/... - 155/164TD 1993/... CHRYSLER: VOYAGER - GRAND VOYAGER 1992/94 - FORD: SCORPIO TDI GRANADA TDI FALCON 1988/... - ROVER: RANGE ROVER TD 1986/89 TOYOTA: LANDCRUISER 70/250 TD 1987/93	Diesel	1995cc.	VM80A	95	88.00	27
			2393cc.	HR 492	110/113	92.00	
			2499cc.	494 TD / HR425	114/125	92.00	

CHANGAN						
REF.	MODELO / MODEL	Cm ³	MOTOR / ENGINE	HP	Ø Pist.	PAG.
JR-736-07	SIRION CS/CE/CD/CSB - MINISTAR CS/CE/CD/CSB - SIRION UTILITY - MINISTAR UTILITY - SIRION FAMILY - MINISTAR FAMILY	970cc.	JL465QB	53	64.00	28
CHERY						
REF.	MODELO / MODEL	Cm ³	MOTOR / ENGINE	HP	Ø Pist.	PAG.
JR-693-07	QQ 2006/...	1083cc.	SQR472 16V	67	72.00	29
JR-759-11	FACE 2007/...	1297cc.	SQR473F 16V	82	73.00	30
JR-798-11	FULWIN 2006/...	1497cc.	SQR477F 16V	107	77.40	31
JR-760	TIGGO 2010/...	1971cc.	SQR484F 16V Acteco	137	83.50	32
CHEVROLET / OPEL						
REF.	MODELO / MODEL	Cm ³	MOTOR / ENGINE	HP	Ø Pist.	PAG.
JR-770-15	SPARK 2003/... - DAEWOO : TICO MATIZ 1998/... DAMAS 1994/... (93740053)	796cc.	F8CV	52	68.50	33
JR-507-15	SPRINT - SUZUKI : SWIFT - CULTUS - VAN TURBO 1984/... (1140082810/14)	993cc.	61-G10-G10T	50	74.00	34
JR-508-15	SPARK 2003/06 - AVEO 2006/... - DAEWOO : MATIZ II 2003/06 - KALOS 2000/... (93740055)	995cc. 1148cc.	B10S F12S3	63 71	68.50 68.50	35
JR-478-15	CORSA - COMBO - CELTA 1990/... TIGRA EFI MPFI - B10 NZ 1994/...	996cc. 1196cc. 1196cc. 1196cc.	OHC C12NZ 12NZ X12SZ	60 45 45 45	71.10 72.00 72.00 72.00	36
JR-521-15	CELTA 2000/... - CLASSIC - SUZUKI : FUN 2002/...	999cc.	C10NE MPFI 8V (SOCH)	60	71.10	38
JR-522-15	CORSA 16V DOCH 1998/...	999cc.	MPFI	68	71.00	40
JR-473-15	CELTA - CLASSIC - CORSA 2003/...	999cc.	MPFI VHC	60	71.10	39
JR-731	ONIX - PRISMA 2013/... - AVEO	999cc.	SPE/4	78/80	71.00	37
JR-771-15	SPARK 2010/... - AVEO 2007/... - DAEWOO : MATIZ 2010/...	1206cc. 1206cc.	73 CID LMU B12D1	82 84	69.70 69.70	41
JR-652-11	CORSA D - ASTRA	1364cc.	A14NEL/NET	118/138	72.50	42
JR-373-15	CORSA GL EFI - KADETT E 1986/91 - CAVALIER 1986/94 - ASCONA C 1986/88 ASTRA 1986/93 - VECTRA A - CHEVY (90442264)	1389cc. 1389cc.	C14NZ/NV OHC	60/75 60/75	77.60 77.60	43
JR-540-15	COMBO 1993/... - CORSA A/B 1991/97 - CORSA - ASTRA 1991/98 CELTA MPFI 2004/... - CHEVY POPULAR 1995/... - MONTANA ECOFLEX 2007/... SWING 1994/98	1389cc. 1389cc.	C14SE - X14NZ LQ5	60/82 85/97	77.60 77.60	44
JR-597	CORSA ECONOFLEX - CLASSIC - AGILE 2009/... - CELTA 2006/09	1389cc.	X14SE/Y14NE	90/92	77.60	45
JR-732	ONIX 2013/... - PRISMA 2013/... - AVEO	1389cc.	SPE/4	106	77.60	46
JR-335-15	CHEVETTE 1973/89 - GM (7329442/96622395)	1393cc. 1599cc.	GMC 85 GMC 98	45 71	82.00 82.00	47
JR-562-15	SAIL 2010/15 (9024764)	1399cc.	LCU S-TEC III (DOHC) 16V	103	73.80	48
JR-800-11	CRUZE - TRACKER 2017/...	1399cc.	LE2	753	74.00	49
JR-551	NUBIRA 2003/05 - OPTRA - AVEO MPI 2004/... - DAEWOO : KALOS LACETTI 2004/... - NUBIRA 2003/05	1399cc. 1598cc.	F14 D3 F16 D3 (DOHC 16V) Descarga simple	94 103/109	77.90 79.00	50
JR-552	NUBIRA 2003/05 - OPTRA - AVEO MPI 2004/... - DAEWOO : KALOS LACETTI 2004/... - NUBIRA 2003/05	1399cc. 1598cc.	F14 D3 F16 D3 (DOHC 16V) Descarga doble	94 103/109	77.90 79.00	51
JR-559	CRUZE 1.8 2008/... - AVEO 1.4 2009/... - ALFA ROMEO : 159 2005/... FIAT : CROMA 2005/... - OPEL : ASTRA H 2004/... - SIGNUM VECTRA C 2006/... ZAFIRA B 2005/... - INSIGNIA 2008/...	1399cc. 1796cc. 1796cc. 1796cc.	F14D4 (DOHC 16V) F18D4 (DOHC 16V) Z18XER/A18XER 939A4 (DOHC 16V)	101 141 141 140	80.50 80.50 80.50 80.50	52
JR-374-15	CORSA GL MPFI - KADETT E 86/93 - VECTRA A 91/97 - ASTRA 86/93 CAVALIER 86/94 - ASCONA C 1986/88 - CHEVY - DAEWOO : CIELO - LEMANS ESPERO 1994/97 - RACER 89/97 - NEXIA (93245889)	1498cc. 1598cc. 1598cc. 1598cc.	G15MF OHC E16SE/NE/NZ C16LZ/NZ/SV	75/78 75 75/82/101 75/82	76.50 79.00 79.00 79.00	53
JR-479-15	MONZA - KADETT 1981/86	1598cc.	CN16 - 16SH	90	80.30	54
JR-123-15	CORSA - ASTRA - ZAFIRA - VECTRA 1993/... - CHEVY - OPEL : TIGRA	1598cc. 1598cc. 1598cc.	C16XE/XEL 16V X16XEL 16V Y16XE 16V	109 100/109 100/109	79.00 79.00 79.00	55
JR-333-15	PICK UP - CORSA - VECTRA - ASTRA - KADETT 1992/... - CHEVY	1598cc. 1598cc.	C16SE 8V X16SZR 8V	100 75	79.00 79.00	56
JR-692-11	SONIC - MONTANA 2011/14	1598cc.	Z16-LER/LET 16V	180/192	80.00	57
JR-651-11	ASTRA J	1598cc. 1598cc.	A16-LET Z16-LEL/XNT	180 150	79.00 79.00	58

CHEVROLET / OPEL - Continuación...							
REF.	MODELO / MODEL		Cm ³	MOTOR / ENGINE	HP	Ø Pist.	PAG.
SJ-502	COMBO TOUR 16V TD 2000/... - CORSA - ASTRA G DTI - CORSA C DI - ZAFIRA MERIVA 1998/..	Diesel	1686cc.	Y17DIT/DTL (DOCH) 16V	65/75	79.00	59
SJ-274	CORSA D - COMBO D 1997/... - VECTRA TD 1991/96 - ASTRA TD 1994/97 CAVALIER TD (97721730) - MAZDA: 323 TD	Diesel	1686cc.	4EE1	60	79.00	60
			1686cc.	4EE1T	82	79.00	
			1686cc.	X17 D-T	60/82	79.00	
JR-553	CORSA II - MERIVA 2003/... OPTRA - DESIGN - FIAT: PALIO FASE II 2004/...		1781cc.	L79 - ALX (DOHC) 16V	122	80.50	61
JR-251-15	OPALA 1968/73 - OPEL: K 180 1974/79		1790cc.	K180 - 153		90.49	257
JR-480-15	MONZA SLE/SEE - KADETT - REKORD 1983/...		1796cc.	C18N S/E	75/90	84.80	62
JR-319	CORSA - MERIVA 2003 - CHEVY - FIAT: STILO - STRADA WORKING ADVENTURE - PALIO 2003		1796cc.	GM Powertrain OHC 171/190 MPFI 8V	102	80.50	63
JR-558	SPIN - COBALT		1796cc.	N18XFN	108	80.50	64
JR-380-15	MONZA 1996/... - ASTRA 1991/... - ASCONA C 1986/1988 - KADETT 1986/91 VECTRA 1988/95 - DAEWOO: ESPERO - LEMANS - RACER - PRINCE - ARANOS LEGANZA COMPACT - NUBIRA II - MAGNUS 1989/... (52272664/92060517)		1796cc.	C18NE - E18SE FII	84/112	84.80	65
			1998cc.	C20NE - C20LE	97/116	86.00	
JR-654-11	CAPTIVA - CRUZE		1991cc.	LLW	125	83.00	66
			1991cc.	Z20DM/DMH	120/125	83.00	
			1991cc.	Z20S/S1	120/125	83.00	
JR-772-07	TRACKER 2006/... - SUZUKI: VITARA 1998/06 - SX4 2006/... GRAND VITARA 1998/06		1995cc.	J20A 16V (DOHC)	120/129	84.00	67
JR-481-15	MONZA 1986/... - KADETT 1989/... - ASTRA - IPANEMA 1989/... (52278189) OPEL: OMEGA A 1986/94 - FRONTERA 1991/95 - CALIBRA - CAVALIER		1998cc.	C20NE/SEH/SER OHC	115/130	86.00	68
			1998cc.	C20NEF/SEH OHC	100/130	86.00	
JR-530-15	VECTRA - ASTRA 1995/... - ZAFIRA - SINTRA 1996/99 - CALIBRA		1998cc.	X20XE (DOHC) 16V	136	86.00	69
			2198cc.	X22XE (DOHC) 16V	142	86.00	
JR-537-15	ASTRA 1995/... - OMEGA B - CALIBRA 1994/... - ZAFIRA 1998/... DAEWOO: LEGANZA 1997/... - NUBIRA I/II 1997/... - MAGNUS 2001/...		1998cc.	X20XE (DOHC) 16V	136	86.00	70
			1998cc.	X22SED (DOHC) 16V	136/148	86.00	
			2198cc.	X22SED (DOHC) 16V	140	86.00	
JR-520-15	VECTRA B - LUV - S10 - CAVALIER 1996/...		1998cc. 2200cc.	20 NEJ	112 112	86.00 86.00	71
JR-554	OPTRA 2007/08		2000cc.	L34 (DOHC) 16V	119	86.00	72
JR-538-15	VECTRA 1997/... - ASTRA		2000cc.	MPFI (SOCH) 8V	116	86.00	73
			2200cc.	MPFI (SOCH) 8V	123	86.00	
SJ-249	SPACEVAN - TRAFIC - JEEP: WAGONEER TD 1984/95 - COMANCHE TD 1986/88 RENAULT: R18 1981/86 - R21 1984/97 - FUEGO - ESPACE - TRAFIC 1981/97 MASTER 1980/... - R20 - R25 - R30	Diesel	2068cc.	852/J8S	60/86	86.00	330
			2068cc.	121	80	86.00	
JR-122-15	LUV - PICK UP 1986/95 - ISUZU: AMIGO - TROOPER II - IMPULSE - ASKA OPEL: BRAVA - CAMPO (5878120663)		2254cc.	4ZD1	88/96	89.30	74
JR-733	CAPTIVA 2011/... - MALIBU - ZAFIRA		2384cc.	A24XE	165	88.00	75
			2384cc.	LE5/LE9 Ecotec 16V	149/160	88.00	
JR-773	ASTRA - VECTRA - BLAZER 2000/12 - ZAFIRA - S10 2001/15		2405cc.	X24XF 8V	146	87.50	76
JR-655	CAPTIVA 2006/... - VECTRA 2006/... - ASTRA 2004/... - ELITE - BLAZER ZAFIRA - S10 2005/...		2405cc.	Z24-SED	135	87.50	77
			2405cc.	X24-SFD	144	87.50	
			2405cc.	MPFI Flexpower	144	87.50	
JR-398-15	OPALA - C10 - A10 1974/... - COMODORO - CARAVAN - A10 1980/84		2475cc.	GM151	90	101.60	78
JR-399-15	OPALA 153 1969/73 - OPALA A10 80/84/610 1976/...		2475cc.	GM153	99	101.60	79
SJ-272	BLAZER TDI - S10 TDI 1995/... - FORD: RANGER TDI 1995/... - RANGER TD BR 2000-2002/... - M. BENZ: SPRINTER TDI 1997/... - ROVER: RANGE ROVER DISCOVERY - DEFENDER TDI 1990/...	Diesel	2495cc.	200 - 300 TDI	107/112	90.50	231
			2507cc.	Power Stroke	95	90.70	
			2758cc.		135	93.00	
SJ-779	TRAILBLAZER 2012/... - S10 2012/... - JEEP: CHEROKEE - LIBERTY - WRANGLER	Diesel	2768cc.	ENS 16V	150	94.00	80
SJ-347	S10 TD - BLAZER TD 2000/... - AGRALE: TD (MICRO-ÓMNIBUS) 2000/... - 6000 FURGON VAN - NISSAN: FRONTIER - X TERRA TD 12V VOLARE: A5 - A6 - A8 - VOLKSWAGEN: LTDI 1997/...	Diesel	2796cc.	AGK	125	93.00	228
			2796cc.	ATA	131	93.00	
			2796cc.	Sprint 4.07 TCA	132	93.00	
JR-117-15	SÚPER SPECIAL - RALLY - SPORT 1962/68 - 400/63 SS - 6 CILINDROS		3185cc.	194		90.48	81
JR-801-11	CAPTIVA 2008/12 - TRAILBLAZER 2013/17 - OMEGA 2005/12 - CAMARO 2011/...		3195cc.	10HM V6 24V	225	89.00	82
JR-232-15	400 1964/72 - RS MALIBU PICK UP SÚPER 1964/69 - SILVERADO CHEYENNE CHEVY 7 BANCADAS 1968/78 - OPALA C10/C20		3769cc.	230		98.43	83
			4047cc.	250		98.43	
JR-118-05	PICK UP APACHE C10 3.9/16 1953/59 - BEL AIR - IMPALA 1953/62 CAMIÓN 4400 1957/... (7364640)	Diesel	3851cc.	235	130	90.48	84
JR-290-20	GM D10/20/40 ASPIRADO TURBO - M. FERGUSON: MF220 - F290 - MF85X MAXION-PERKINS: F350 - VW680 - CASE 550 - VEHICULAR (424801/423607)	Diesel	3860cc.	Q20B4 - 4.236	70	98.40	260
			4070cc.	4.248	70	101.00	
JR-281-20	GM D20 - D40 - PICK UP D20 - GMC 6150/6100 - F1000 MAXION: S4/S4T/ST4 PLUS	Diesel	3990cc.	Maxion S4	102	100.00	234
JR-334-15	C20 CUSTOM - PICK UP C10 1989/...		4097cc.	250		98.47	85

CHEVROLET / OPEL - Continuación...						
REF.	MODELO / MODEL		Cm ³	MOTOR / ENGINE	HP	Ø Pist. PAG.
JR-318-15	PICK UP 7 BANCADAS - SILVERADO - CHEYENNE		4097cc.	250		98.43 86
SJ-348	GM SILVERADO 3500HD/DLX 1997/... - GM GRAND BLAZER 1998/... FORD: F100 GMC TURBO 1999/...	Diesel	4200cc. 4200cc.	Sprint 6.07 TD Turb. Intercooler	167 198	93.00 93.00 230
JR-691-07	S10 1996/2011 - BLAZER - ZAFARI - SONOMA		4294cc.	Vortec 262	180	101.60 87
CHRYSLER						
REF.	MODELO / MODEL		Cm ³	MOTOR / ENGINE	HP	Ø Pist. PAG.
SJ-230	VOYAGER - GRAND VOYAGER 1992/94 - ALFA ROMEO: 75/90TD 1983/... 155/164TD 1993/... - BORGWARD: VM TURBO - FORD: SCORPIO TDI - GRANADA TDI - FALCON 1988/... - ROVER: RANGE ROVER TD 1986/89 TOYOTA: LANDCRUISER 70/250 TD 1987/93	Diesel	1995cc. 2393cc. 2499cc.	VM80A HR 492 494 TD / HR425	95 110/113 114/125	88.00 92.00 92.00 27
SJ-476	PICK UP POWER RAM 50 TD 1983/85 - FORD: BRONCO II TD - RANGER 2WD 1985/... - HYUNDAI: H100 - H1 D/TD 1986/... - GALLOPER - LIBERTO 1998/... MITSUBISHI: L200 1987/... - CANTER - T35 - PAJERO - MONTERO 1986... (MD972160)	Diesel	2346cc. 2476cc. 2476cc. 2607cc.	4D55T 4D56 D4BA - X/D4BH D4BB	67/84 70/84 75/100 85	91.00 91.00 91.10 91.10 243
JR-802-11	PT CRUISER 2005/...		2429cc.	EDZ 16V	140	87.50 88
JR-803-11	CARAVAN 1995/00 - VOYAGER		2429cc.	B00 16V	151	87.50 89
JR-804-11	STRATUS V6 2001/06 - DODGE: JOURNEY V6 2008/...		2736cc. 2736cc.	EER EES	181 177	86.00 86.00 90
JR-472-15	CARAVAN - GRAND CARAVAN - IMPERIAL - VOYAGER - GRAND VOYAGER NEW YORKER - TOWN & COUNTRY 1990/99		3301cc.	201 (R00) V6	152/162	93.00 91
CITROEN						
REF.	MODELO / MODEL		Cm ³	MOTOR / ENGINE	HP	Ø Pist. PAG.
JR-694-15	SAXO - ZX - BERLINGO 1996/... - C15 1988/... - AX 10 1986/... PEUGEOT: 106 1991/... - 205 1987/93 - 306 - PARTNER 1996/...		954cc. 1124cc.	TU9/K/MZ/M TU1M	45/50 54/60	70.00 72.00 261
JR-805-11	C1 2005/... - DAIHATSU: SIRION - STORIA 2005/... - PEUGEOT: 107 2005/... TOYOTA: IQ - AYGO - YARIS 2008/...		998cc.	1KR-FE	65	71.00 93
JR-381-15	VISA II - C15 - VISA SUPER - PEUGEOT: 104 1975/... - 205 1983/87		1124cc. 1219cc.	XW3-XW7 XZ5	55/57 57	72.00 75.00 262
JR-379-15	AX11 - AX SPORT 1987/91 - AX GTI 1992/... - BX11 - BX14 - ZX 1991/98 - C15 1986/... - SAXO - XSARA - PEUGEOT: 106 1991/... - 205 1987/96 - 205 RALLYE 1988/93 - 206 1998/... - 306 1993/97 - 405 1987/96 - PARTNER 1996/...		1124cc. 1294cc. 1360cc.	TU1/TU1M TU2.4 TU3	55/60 102 95/100	72.00 75.00 75.00 263
JR-785-11	C3 III - PEUGEOT: 208		1199cc.	EB2M (HMY) 12V	72	75.00 264
JR-469-20	AX 14 1988/94 - PEUGEOT: 106 1994/...	Diesel	1360cc. 1360cc.	TUD3 TUD3 (K9A)	52 50	75.00 75.00 266
JR-509-15	C2 - C3 - C3 PLURIEL 2002/... - BERLINGO 1996/... - SAXO ZX 1991/... FIAT: QUBO - FIORINO QUBO - PEUGEOT: 106 1991/... - 206 1998/... 207 COMPACT - 306 1993/... - 307 2001/... - PARTNER 1996/...		1360cc.	TU3JP	68/75	75.00 267
SJ-542	C3 - C2 HDI - C1 - XSARA HDI 2002/... - FORD: FIESTA - ECOSPORT TD 2003/... DURATORQ TDCI 1996/98 - FUSION TDCI 2001/... - PEUGEOT: 107 - 206 - 307 1007 - BIPPER HDI 2001/...	Diesel	1398cc. 1398cc. 1398cc. 1398cc.	F6JA - F6JB DV4TD(8HX) DV4TD(8HZ) (SOHC) 8V Duratorq	68 54/70 68 68	73.70 73.70 73.70 73.70 146
JR-796-11	C3 III 8V - PEUGEOT: 208	Diesel	1398cc.	DV4C (8HP/8HR)	68	73.70 268
JR-778	C3 PICASSO 2013/... - PEUGEOT: 208 ACTIVE/ALLURE 2013/...		1450cc.	TU4 8V	90	75.00 269
JR-489-20	AX 15 1994/97 - SAXO 1996/... - NISSAN: MICRA 1997/... PEUGEOT: 106 1994/... - ROVER: 115TD 1995/98	Diesel	1527cc. 1527cc.	TUD5 (VJY) TUD5 (VJZ)	55/58 55/58	77.00 77.00 270
SJ-541	XSARA - PICASSO - JUMPY - BERLINGO 1999/... - C2 - C3 - C4 - C5 TD 16V FORD: CMAX - FOCUS - FUSION TDCI 16V 2003/... - PEUGEOT: 307 HDI 2004/... 407 TD 2004/... - 206 - 207 COMPACT - 1007 2003/... VOLVO: S40 - V50 - C30 2005/...	Diesel	1560cc. 1560cc. 1560cc. 1560cc.	DV6TED4 DV6TD4(9HZ) DV6TED4(9HZ) G8DA - Duratorq (DOHC) 16V	75/109 108 104 90/109	75.00 75.00 75.00 75.00 149
JR-786-11	BERLINGO - C4 - C-ELYSEE - PEUGEOT: PARTNER		1560cc.	DV6DTE (9HF/HJ/HP)	90	75.00 271
JR-370	BX19 1984/93 - BX16 1985/90 - BX16 GTI 1991/93 - PEUGEOT: 305 GTX - 306 309 GT 405 1987/93		1580cc. 1905cc. 1905cc. 1905cc.	XU5CP - XU5M XU92C/5 XU9M XU9J1/J2	75/105 96/125 98 102	83.00 83.00 83.00 83.00 272
JR-511	BERLINGO - C3 PLURIEL - XSARA 2000/... - C2 - C3 2002/... - PEUGEOT: 206 307 - PARTNER 2000/... - 207 SW - 207 COMPACT		1587cc.	TU5JP4 (NFU/N6A) 16V	109	78.50 273
JR-515	ZX - SAXO 1996/... - XSARA 1997/... - PEUGEOT: 106 1994/... - 306 1993/... 206 1998/...		1587cc.	TU5JP/J2	90/103	78.50 274
JR-571	C4/PICASSO/GRAND - PICASSO 2008/... - C5/TOURER 2009/... - DS3 2010/... PEUGEOT: 207/CC - 208 2012/... - 308/SW 2007/... - 508/SW/RCZ 2010/... 3008 2009/...		1598cc. 1598cc. 1598cc. 1598cc.	EP6DT (5FX/5FR) EP6DT (5FV/5FT) EP6CDT (5F04) EP6DTS (5FY)	150/156 150/163 156 156	77.00 77.00 77.00 77.00 275



CITROEN - Continuación...							
REF.	MODELO / MODEL		Cm ³	MOTOR / ENGINE	HP	Ø Pist. PAG.	
JR-385	XSARA1997/... - XANTIA 1997/01 - EVASION - SYNERGIE - ZX 1992/98 BERLINGO 1997/... - PEUGEOT: 306 1993/... - 405 - 406 1992/... - 806 EXPERT 1996/... - PARTNER 1996/...		1761cc.	XU7 JP/Z 8V	98/101	83.00	277
			1761cc.	XU7 JB 8V	90/103	83.00	
JR-387	BERLINGO 1997/... - XANTIA - XSARA - PEUGEOT: PARTNER 1996/...		1761cc.	XU7JB	90	83.00	278
JR-394-15	XSARA 1997/... - ZX - XANTIA 1995/... - PEUGEOT: 306 1997/2003 406 1995/2000 (B197X170)		1761cc.	XU7 JP4(LFY) 16V	112	83.00	279
JR-594-15	XSARA 1997/00 - PEUGEOT: 406 1995/00		1761cc.	XU7 JP4(LFY) 16V	112	83.00	280
SJ-259	XANTIA TD - ZX TD 1993/... - BX 17TD 1988/92 - C15 1994/... - BERLINGO 1996/99 - XSARA 1997/... - FIAT: DUCATO TD 1994/... - HYUNDAI: LANTRA 1998/... - LADA: NIVA 2121 - ALEKO 1990/... - PEUGEOT: 205 - 305 - 306 - 309 405 - 406 - 806 TD - EXPERT T/TD - PARTNER - BOXER TD 1992/... ROVER: 218 - 418 T/TD 67HP 1991/96 - SUZUKI: VITARA 68HP 1995/96	Diesel	1769cc.	XUD7 161A/A9A	60	80.00	281
			1769cc.	XUD7 T-TE	78/90	80.00	
			1905cc.	XUD9	65/69	83.00	
			1905cc.	XUD9 TE-TF GRD	90/92	83.00	
JR-233-15	C25 1981/... - PEUGEOT: 504 - 505 - J5 - J7 - XE - XL - XSE 1973/93 FIAT: DUCATO 1981/... (0199416)		1796cc.	280/A14-169B	67	84.00	282
			1796cc.	XC7 - XM7/T/P	69/79	85.00	
SJ-257	BERLINGO - XSARA - JUMPY - C15 1998/... - FIAT: SCUDO 1998/... PEUGEOT: 206 - 306 - 806 - EXPERT - PARTNER 1998/... - TOYOTA: COROLLA 1999/2001 (424801/423607/0197X6)	Diesel	1867cc.	DW8 DWJ DWY	69/70	82.20	284
			1868cc.	DW8 (WJZ)	71	82.20	
			1868cc.	1WZ	69	82.20	
SJ-258	BERLINGO - XSARA - JUMPY - C15 1998/... - FIAT: SCUDO 1998/... PEUGEOT: 206 - 306 - 806 - EXPERT - PARTNER 1998/... - TOYOTA: COROLLA 1999/2001 (424801/423607/0197X6) (JVS REFORMA PLANA)	Diesel	1867cc.	DW8 DWJ DWY	69/70	82.20	285
			1868cc.	DW8 (WJZ)	71	82.20	
			1868cc.	1WZ	69	82.20	
JR-286-15	CX - ATHENS - JEEP: WRANGLER 83/86 - RENAULT: R18 LX/TS/TX/TXE/GTX/GTII R21 TXE - TRAFIC 1989/... - MASTER 1981/93 - ESPACE 1984/97 - FUEGO GTX/GTXII/GTA 1981/86		1995cc.	829-J5R/6R/7R	80/102	88.00	327
			2165cc.	851-J7T	120	88.00	
JR-512	XSARA - EVASION 1998/... C4 2004/... - C5 2001/... - JUMPY - DISPACHT C8 2000/... - PEUGEOT: 206 - 307 - 406 - 407 - 607 2001/... - 806 - 807 EXPERT 2000/... 16V		1997cc.	EW10J4 RFN	136	85.00	288
			1997cc.	EW10D RLZ	147	85.00	
SJ-397	XANTIA - XSARA - BERLINGO - C5 - EVASION - SYNERGIE - JUMPY HDI DISPACHT HDI - XSARA PICASSO HDI - JUMPER HDI - PEUGEOT: 206/306/406 TD 307 HDI - BOXER HDI - 406/607/806 HDI - EXPERT - PARTNER TD 1999/... SUZUKI: VITARA - GRAND VITARA 2000/...	Diesel	1997cc.	DW10 ATED-RHZ	110	85.00	289
			1997cc.	DW10 TD-RHV	110	85.00	
			1997cc.	DW10 TD-RHY	90	85.00	
JR-592	C4/PALLAS - C4 GRAND PICASSO 2005/... - C5 2008/... PEUGEOT: 307 - 407 - 807 2005/...		1997cc.	EW10JA (RFJ) 16V	136/140/143	85.00	290
JR-790	JUMPY III - C4 - PEUGEOT: EXPERT III - 3008 (0197AW)	Diesel	1997cc.	DW10CTED4 (RHC/D/E/H)	150/160	85.00	291
SJ-572	EVASION 2000/... - C5/C8 2001/... - JUMPY 2002/...HDI - FORD: FOCUS - C-MAX TDCI 2003/... - LANCIA: PHEDRA JTD - ZETA JTD 2000/... PEUGEOT: 406/607/806/807 HDI 2000/... - EXPERT HDI 1999/...	Diesel	1997cc.	DW10ATED4	109	85.00	292
			1997cc.	DW10JATED4	110	85.00	
			1998cc.	G6DA/G6DC	135	85.00	
			2179cc.	DW12TED4 (DOHC)	130/133	85.00	
JR-386-15	XM - XANTIA - SINERGIE TURBO 1995/... - EVASION PEUGEOT: 406 - 605 - 806 TURBO 1993/...		1998cc.	XU10 J2TE	150	86.00	294
JR-396-15	ZX 1992/... - XANTIA 1993/98 - JUMPER 1994/... - EVASION PEUGEOT: 306 1993/... - 405 1992/... - 806 - BOXER 1994/...		1998cc.	XU10 J2C	123	86.00	293
			1998cc.	XU10 J2U Iny. Multipunto	109	86.00	
JR-505-15	XSARA 2000/... - XANTIA 1995/2001 - EVASION 1998/... - SYNERGIE 1998/... PEUGEOT: 306 1997/... - 405 1995/... - 406 1995/... - 605 1995/... - 806 1998/... (019767/X8)		1998cc.	XU10 J4R 16V	132/135	86.00	295
			1998cc.	XU10 J4R (RFV) 16V	132/135	86.00	
JR-791-11	JUMPER III - PEUGEOT: BOXER III 2006/...	Diesel	2198cc.	4HU/4HV (P22DTE) Puma	100/120	86.00	296
SJ-560	JUMPER HDI 2006/... - FIAT: DUCATO 2006/... - FORD: RANGER XL 4X2/4X4 TDCI TRANSIT TDCI 2006/... - PEUGEOT: BOXER HDI 2006/...	Diesel	2198cc.	Puma TDCi eTGV	123	86.00	169
			2198cc.	4HU/4HV (P22DTE) (DOHC) 16V	101/120	86.00	
JR-598	JUMPER III HDI 2008/... - FIAT: DUCATO JTD MULTIJET 2006/... IVECO: DAILY III/V 2006/... - PEUGEOT: BOXER MANAGER HDI 2006/...	Diesel	2999cc.	F1CE0481/A/D (30DT) F30DT/FG30DT 16V	136/156 156	95.80 94.40	137

DAIHATSU							
REF.	MODELO / MODEL		Cm ³	MOTOR / ENGINE	HP	Ø Pist. PAG.	
JR-690-11	SIRION 1998/... 12V (0411197201000)		989cc.	EJ-DE	54	72.00	92
JR-805-11	SIRION - STORIA 2005/... - CITROEN: C1 2005/... - PEUGEOT: 107 2005/... TOYOTA: IQ - AYGO - YARIS 2008/...		998cc.	1KR-FE	65	71.00	93
JR-689-07	CHARADE - FERROZA 1988/... - TERIOS 1992/... - APPLAUSSE 1989/... ROCKY 1990/... (0411187108/09/11/12/16/23)		1296cc.	HC	60/65	76.00	94
			1590cc.	HD	90/95	76.00	
JR-722-07	ROCKY 1993/01 - TOYOTA: DYNA 200 1995/... - HILUX 1989/93 - LITEACE - STOUT TOWNACE VAN - VAN WAGON 1986/90 (0411173040/73046/72010)	Diesel	2237cc.	4Y	93/94	91.00	350
			2237cc.	4Y-EC	94/98/101	91.00	

DAEWOO							
REF.	MODELO / MODEL		Cm ³	MOTOR / ENGINE	HP	Ø Pist. PAG.	
JR-770-15	TICO MATIZ 1998/... DAMAS 1994/... - CHEVROLET: SPARK 2003/... (93740053)		796cc.	F8CV	52	68.50	33

DAEWOO - Continuación...							
REF.	MODELO / MODEL	Cm ³	MOTOR / ENGINE	HP	Ø Pist.	PAG.	
JR-508-15	MATIZ II 2003/06 - KALOS 2000/... - CHEVROLET: SPARK 2003/06 AVEO 2006/... (93740055)	995cc.	B10S	63	68.50	35	
		1148cc.	F12S3	71	68.50		
JR-771-15	MATIZ 2010/... - CHEVROLET: SPARK 2010/... - AVEO 2007/...	1206cc.	73 CID LMU	82	69.70	41	
		1206cc.	B12D1	84	69.70		
JR-551	KALOS - LACETTI 2004/... - NUBIRA 2003/05 - CHEVROLET: NUBIRA 2003/05 OPTRA - AVEO MPI 2004/... -	1399cc.	F14 D3	94	77.90	50	
		1598cc.	F16 D3 (DOHC 16V) Descarga simple	103/109	79.00		
JR-552	KALOS - LACETTI 2004/... - NUBIRA 2003/05 - CHEVROLET: NUBIRA 2003/05 OPTRA - AVEO MPI 2004/... -	1399cc.	F14 D3	94	77.90	51	
		1598cc.	F16 D3 (DOHC 16V) Descarga doble	103/109	79.00		
JR-374-15	CIELO - LEMANS - ESPERO 1994/97 - RACER 89/97 - NEXIA CHEVROLET: CORSA GL MPFI - KADETT E 86/93 - VECTRA A 91/97 - ASTRA 86/93 CAVALIER 86/94 - ASCONA C 1986/88 - CHEVY (93245889)	1498cc.	G15MF	75/78	76.50	53	
		1598cc.	OHC	75	79.00		
		1598cc.	E16SE/NE/NZ	75/82/101	79.00		
		1598cc.	C16LZ/NZ/SV	75/82	79.00		
JR-380-15	ESPERO - LEMANS - RACER - PRINCE - ARANOS - LEGANZA - COMPACT NUBIRA II MAGNUS 1989/... - CHEVROLET: MONZA 1996/... - ASTRA 1991/... ASCONA C 1986/1988 - KADETT 1986/91 - VECTRA 1988/95 (52272664/92060517)	1796cc.	C18NE - E18SE FII	84/112	84.80	65	
		1998cc.	C20NE - C20LE	97/116	86.00		
JR-537-15	LEGANZA 1997/... - NUBIRA I/II 1997/... - MAGNUS 2001/... CHEVROLET: ASTRA 1995/... - OMEGA B - CALIBRA 1994/... - ZAFIRA 1998/...	1998cc.	X20XEV (DOHC) 16V	136	86.00	70	
		1998cc.	X22SED (DOHC) 16V	136/148	86.00		
		2198cc.	X22SED (DOHC) 16V	140	86.00		

DI TELLA

REF.	MODELO / MODEL	Cm ³	MOTOR / ENGINE	HP	Ø Pist.	PAG.
JR-128-15	SIAM DITELLA 1500- ARGENTA 1961/67 - TRAVALLER - RILEY 1500 - PICK UP RILEY 1500 - MAGNETTE 1622 60/66 - MORRIS 1650 (137541/48G131)	1489cc.	BMC 1500		73.20	95
		1622cc.	BMC 1600		76.20	

DODGE

REF.	MODELO / MODEL	Cm ³	MOTOR / ENGINE	HP	Ø Pist.	PAG.
JR-130-15	D1500 1971/81 - D1800 1975/81 - PAIKAN - GT90 - GT100 1971/... VOLKSWAGEN: 1500 - 1800 1982/...	1498cc.	Hillman	72	86.00	96
		1798cc.	Hillman	110	86.00	
JR-807-11	JOURNEY 2012/... - FIAT: FREEMONT 2011/... - JEEP: COMPASS 2010/...	2360cc.	ED3 16V	170/175	88.00	132
		2360cc.	EDG 16V	170/175	88.00	
JR-804-11	JOURNEY V6 2008/... - CHRYSLER: STRATUS V6 2001/06	2736cc.	EER	181	86.00	90
		2736cc.	EES	177	86.00	
JR-221-15	VALIANT I/II/III/IV - D100 - D2800 - POLARA - GT CORONADO - RT 1964/79 GTX PICK UP 1962/80 (2488777)	2788cc.	170	130	86.36	361
		3687cc.	225	130	86.36	
JR-190	POLARA - D100 - D200 1987/... - FORD: F100 - PICK UP - FALCON 1970/... JEEP: T1000 1969/80	Diesel 3336cc.	4.203 - P4 - 192Z	71	91.49	258

ESTANCIERA / IKA

REF.	MODELO / MODEL	Cm ³	MOTOR / ENGINE	HP	Ø Pist.	PAG.
JR-135-05	IKA: ESTANCIERA - BAQUEANO - GLADIATOR - CONTINENTAL - BERGANTIN SUPER 1954/67 - KAISER CARABELA - MANHATTAN 1955/... (2090610)	3705cc.	L226	110	84.14	97

FIAT

REF.	MODELO / MODEL	Cm ³	MOTOR / ENGINE	HP	Ø Pist.	PAG.
JR-137-15	600 E.R.S. - 750 1961/80 - 800 SPIDER 1962/76 - 770 - 800 - 850 COUPE SEAT: 133 850 - 127 1972/78 - IBIZA 82/88 - ZASTAVA 750	767cc.	100D - 170R	32	62.00	98
JR-283-15	133 - 600S - BERLINA 1977/82 - UNO 45 - 850 - 850 VAN 1965/76 - 127 ESPECIAL 1974/... - SEAT: 133 - 850 - 127 1972/78 - IBIZA 82/88 - FURA PANDA - MARBELLA TERRA	843cc.	100R	32	62.50	99
		843cc.	100G	37	65.00	
		843cc.	08NCA	35	65.00	
		903cc.	08/09NCA - 146A	40/45	65.00	
JR-353-15	PALIO 1.0 ED/EDX MPI 96 - UNO MILLE - PALIO 1.5 EL MPI 96 - SIENA ALBEA - YOUNG	994cc.	ED/EDX MPI Fiasa	48/61	76.00	101
		1495cc.	EL MPI	76	76.00	
JR-383-15	UNO MILLE - PALIO - SIENA 1983/... - PREMIO - FIORINO - ELBA	994cc.	146B4	48/61	76.00	100
		1301cc.	146A5	67	76.00	
		1497cc.	Fiasa	76	76.00	
JR-492	UNO - PALIO - SIENA - PUNTO - MILLE FIRE - ALBEA	999cc.	Fire 8V MPI	55/65	70.00	103
		1242cc.	Fire 8V MPI	73/75	70.80	
JR-352-15	UNO - SMART - PUNTO SS 1993/99 - SEICENTO - CINQUECENTO - UNO 45 - FIRE PANDA - TIPO 1989/95 - PALIO - LANCIA Y10I	999cc.	156A2000/2246	30/45	70.00	102
		1108cc.	156C046	49/55	70.00	
		1108cc.	146C3000	49/55	70.00	
		1108cc.	176B2000	49/55	70.00	
JR-493	PALIO - SIENA - PALIO NOVO - DOBLO - PALIO WEEKEND - NOVO SIENA BRAVA - ALBEA - BRAVO - STILO 16V 2000/... - LANCIA: YPSILON 2000/...	999cc.	Fire 16V-1714130	70	70.00	104
		1242cc.	Fire 16V	80	71.00	
		1242cc.	188 A5000	60	70.80	

FIAT - Continuación...							
REF.	MODELO / MODEL		Cm ³	MOTOR / ENGINE	HP	Ø Pist.	PAG.
JR-369-15	147 - OGGI - PANORAMA - UNO - ELBA - PREMIO - TREND - FIORINO (7073000/418)		1049cc.	127AB 206	60/70	76.00	106
			1300cc.	127AB 2C	60/70	76.00	
JR-140-15	1100/103 1961/64		1089cc.		65	68.50	107
JR-138-15	128 - 147 - SPAZIO - BRIO - RITMO 60 - EUROPA C 1970/81 STRADA 60 1971/... (1041169)		1116cc.	128A	55/60	80.00	108
JR-593	PALIO II/III 2007/13 - GRANDE SIENA - UNO ATTRACTIVE/WAY 2011/... PUNTO ATTRACTIVE - IDEA 2009/... - 500 2007/... - LÍNEA 2007/... STRADA III - FIORINO		1242cc.	350 A1.000	70/77	72.00	105
			1368cc.	169 A4.000 Fire Evo 8V	80/82	72.00	
SJ-564	STRADA TREKKING III JTD 2010/... - PALIO JTD - PUNTO ELX JTD 2003/...	<i>Diesel</i>	1248cc.	188 A9.000 (DOHC) 16V	70	69.60	109
JR-230-15	128 1971/81 - RITMO - SPAZIO - STRADA 78/85 - EUROPA - 147 - FIORINO RITMO UNO 70 - REGATTA - DUNA - LANCIA: DELTA - PRISMA 1978/83 (1041194)		1290cc.	128A1	73	86.40	110
			1301cc.	138B2	68/70	86.40	
			1301cc.	831B	75/80	86.40	
			1498cc.	138A/A2/A4	75/85	86.40	
SJ-235	147 - DUNA - FIORINO - SPAZIO - A992 - UNO 1985/...	<i>Diesel</i>	1301cc.	4TD - 146B	45	76.10	111
JR-806-11	MOBI DRIVE 2017/... - ARGO DRIVE 2017/... - CRONOS DRIVE 2017/... UNO WAY		1332cc.	Firefly GSE N4	99	70.00	112
JR-509-15	QUBO - FIORINO QUBO - CITROEN: C2 - C3 - C3 PLURIEL 2002/... BERLINGO 1996/... - SAXO ZX 1991/... - PEUGEOT: 106 1991/... - 206 1998/... 207 COMPACT - 306 1993/... - 307 2001/... - PARTNER 1996/...		1360cc.	TU3JP	68/75	75.00	267
JR-496	STRADA - PALIO - SIENA		1368cc.	Fire 8V	80/81	72.00	113
JR-340-15	SPAZIO - DUNA - TIPO - VIVACE - PALIO - SIENA 1988/91 - UNO FIORINO 1993/95 TEMPRA (7604403)		1372cc.	160A1	71	80.50	114
			1372cc.	146C1/5	67/72	80.50	
			1372cc.	159A2	78	80.50	
JR-559	CROMA 2005/... - ALFA ROMEO: 159 2005/... - CHEVROLET: CRUZE 1.8 2008/... AVEO 1.4 2009/... - OPEL: ASTRA H 2004/... - SIGNUM VECTRA C 2006/... ZAFIRA B 2005/... - INSIGNIA 2008/...		1399cc.	F14D4 (DOHC 16V)	101	80.50	52
			1796cc.	F18D4 (DOHC 16V)	141	80.50	
			1796cc.	Z18XER/A18XER	141	80.50	
			1796cc.	939A4 (DOHC 16V)	140	80.50	
JR-141-15	1500 BERLINA - MULTICARGA 1963/72 - FAMILIAR - 1600 BERLINA - COUPE 1969/72 - SEAT: 1500 1963/71		1481cc.	115 C/BT.038	72	77.00	115
			1600cc.	115 C.2038/20	76	78.00	
JR-294-15	128 - REGATTA - DUNA - RITMO 1986/90 - ELBA - PREMIO - FIORINO - UNO S.EUROPA 1983/... - LANCIA: DELTA - PRISMA 1986/... (1041254)		1498cc.	138C3	75/85	86.40	116
			1498cc.	831B1	82/85	86.40	
JR-384-15	RITMO - PREMIO - FIORINO - UNO 75CV IE - REGATTA 1986/...		1498cc.	149C1.000	75	86.40	117
			1498cc.	138/C3.048/1.048/3.048	75	86.40	
			1498cc.	483C3.149	75/76	86.40	
			1498cc.	149A5.000	75	86.40	
JR-341-15	DUNA - UNO - REGATTA - PALIO - SIENA - ELBA - PREMIO - TIPO - FIORINO 1988/... TEMPRA - PUNTO - LANCIA: DEDRA 1989/93 (7604404/7564332)		1581cc.	Sevel	84/88	86.40	118
			1581cc.	146C6	75	86.40	
			1581cc.	159A3	76/86	86.40	
			1581cc.	160A2 - 835A	80/82/90	86.40	
JR-382-15	PALIO - SIENA - TIPO 1,6 - BRAVO - MAREA - TORQUE 16V - STRADA - BRAVA MULTIPLA 1999/... - LANCIA: DELTA - DEDRA - LYBRA 1996/...		1581cc.	178B	103	86.40	119
			1581cc.	182A4	103	86.40	
			1581cc.	182A6	90/103	86.40	
			1581cc.	185A3	103	86.40	
			1581cc.	186A4	103	86.40	
JR-295-15	ARGENTA - RITMO - REGATTA 100S 1985/... - STRADA - 131 SUPER MIRAFIORI 124 1972/78 - 132 1977/85 - LANCIA: BETA - TREVI - PRISMA - DELTA 1982/84		1585cc.	149A	100	84.00	122
			1585cc.	138 ARO/2ACT	98/105	84.00	
			1756cc.	132 A70	105/118	84.00	
			1995cc.	132 C2	113/115	84.00	
JR-358-15	REGATTA 100 - 2000 - TEMPRA 1989/... - BIALBERO 8V - TIPO IE - RITMO 100 CROMA IE - LANCIA: DELTA HF TURBO - DEDRA INTEGRALE - PRISMA - THEMA IE		1585cc.	149 A4048	83/100	84.00	123
			1585cc.	831B 6000	90/96	84.00	
			1995cc.	835A 7000	169/180	84.00	
			1995cc.	154C A1000	90/110	84.00	
JR-753-15	PALIO - SIENA - MAREA - MULTIPLA 2001/...		1596cc.	182 B6.000	103	86.40	120
			1596cc.	178 E7.000 Torque 16V	90/103	86.40	
JR-734	STRADA - WEEKEND - PUNTO - IDEA - LINEA PALIO ESSENCE - GRAND SIENA 2011/...		1598cc.	E-Torq Flex 16V	117	77.00	121
JR-193-15	125 1973/81 - BERLINA - SPORT - MULTICARGA - MIRAFIORI 1972/74		1608cc.	125AB - 125A	110	80.00	124
SJ-246	FIORINO - DUCATO - UNO - TIPO - PALIO - DUNA - TEMPRA - REGATTA - SIENA TD ALFA ROMEO: 145/146 - 155 TD 1993/99 - LANCIA: DELTA - DEDRA 1994/99		1697cc.	149B	58	82.60	125
			1697cc.	176A	69/71	82.60	
			1929cc.	160D-280A1	65	82.60	
			1929cc.	675.01-336.01	90	82.60	
JR-735	STRADA ADVENTURE - DOBLO ADVENTURE /CARGO - WEEKEND ADVENTURE PUNTO - BRAVO - LINEA - IDEA ADVENTURE 2011/...		1747cc.	E-Torq Flex 16V	132	80.50	126

FIAT - Continuación...						
REF.	MODELO / MODEL		Cm ³	MOTOR / ENGINE	HP	Ø Pist. PAG.
JR-354-15	TEMPRA IE 16V - TIPO IE 16V - CROMA IE 16V 1990/96 - COUPE IE 16V ALFA ROMEO: 155 TURBO 16V - LANCIA: DELTA INTEGRALE 1986/92 - THEMA TURBO 16V DEDRA IE - KAPPA (7076950)		1756cc.	160 A5000	138	84.00
			1995cc.	836 A3000/11	142	84.00
			1995cc.	834 C1246/2 - Zact 16V	126/145/180	84.00
			1995cc.	154E1000/27/160A8046	140/145	84.00
SJ-259	DUCATO TD 1994/... - CITROEN: XANTIA TD - ZX TD 1993/... - BX 17TD 1988/92 C15 1994/... - BERLINGO 1996/99 - XSARA 1997/... - HYUNDAI: LANTRA 1998/... - LADA: NIVA 2121 - ALEKO 1990/... - PEUGEOT: 205 - 305 - 306 - 309 405 - 406 - 806 TD - EXPERT T/TD - PARTNER - BOXER TD 1992/... ROVER: 218 - 418 T/TD 67HP 1991/96 - SUZUKI: VITARA 68HP 1995/96		1769cc.	XUD7 161A/A9A	60	80.00
			1769cc.	XUD7 T-TE	78/90	80.00
			1905cc.	XUD9	65/69	83.00
			1905cc.	XUD9 TE-TF GRD	90/92	83.00
JR-553	PALIO FASE II 2004/... - CHEVROLET: CORSA II - MERIVA 2003/... OPTRA DESIGN		1781cc.	L79 - ALX (DOHC) 16V	122	80.50
JR-233-15	DUCATO 1981/... - CITROEN: C25 1981/... - PEUGEOT: 504 - 505 - J5 J7- XE - XL - XSE 1973/93 (0199416)		1796cc.	280/A14-169B	67	84.00
			1796cc.	XC7 - XM7/T/P	69/79	85.00
JR-466-15	STRADA - PALIO - STILO - PALIO FLEX - SIENA FLEX 2003/... BR - IDEA ADVENTURE HLX - G2 - G3 2006/... BR		1796cc.	OHC 171/190	103	80.50
			1796cc.	17241C1	103	80.50
			1796cc.	G2	102/105	80.50
			1796cc.	G3	110	80.50
JR-319	STILO - STRADA WORKING - ADVENTURE - PALIO 2003 - CHEVROLET: CORSA MERIVA 2003 - CHEVY		1796cc.	GM Powertrain OHC 171/190 MPFI 8V	102	80.50
SJ-257	SCUDO 1998/... - CITROEN: BERLINGO - XSARA - JUMPY - C15 1998/... PEUGEOT: 206 - 306 - 806 - EXPERT - PARTNER 1998/... - TOYOTA: COROLLA 1999/2001 (424801/423607/0197X6)		1867cc.	DW8 DWJ DWY	69/70	82.20
			1868cc.	DW8 (WJZ)	71	82.20
			1868cc.	1WZ	69	82.20
SJ-258	SCUDO 1998/... - CITROEN: BERLINGO - XSARA - JUMPY - C15 1998/... PEUGEOT: 206 - 306 - 806 - EXPERT - PARTNER 1998/... - TOYOTA: COROLLA 1999/2001 (424801/423607/0197X6) (JVS REFORMA PLANA)		1867cc.	DW8 DWJ DWY	69/70	82.20
			1868cc.	DW8 (WJZ)	71	82.20
			1868cc.	1WZ	69	82.20
JR-357-15	CROMA IE TURBO 1991/96 - TIPO IE - TEMPRA IE 1990/95 (7096175) LANCIA: THEMA IE 1985/92		1995cc.	154 C4000/46	153/155	84.00
			1995cc.	159 A6096/11	115	84.00
			1995cc.	834 B146	115/120	84.00
			1995cc.	Zact 8V	120/153	84.00
JR-527-15	MAREA 1996/98 182 A1 - COUPE 1996/2001 - BRAVO 1995/98 - MAREA 1998/... 182 E - LANCIA: KAPPA - LIBRA 1996/00		1998cc.	182A1	147	82.00
			1998cc.	838A1/A6	145/155	82.00
			1998cc.	182B3/B7	147/155	82.00
SJ-560	DUCATO 2006/... - CITROEN: JUMPER HDI 2006/... - FORD: RANGER XL 4X2/4X4 TDCI TRANSIT TDCI 2006/... - PEUGEOT: BOXER HDI 2006/...		2198cc.	Puma TDCI eTGV 4HU/4HV (P22DTE)	123	86.00
			2198cc.	(DOHC) 16V	101/120	86.00
SJ-595	DUCATO JTD MULTIJET 16V 2002/... - IVECO: DAILY III 16V 2002/... (504049360)		2286cc.	F1AE0481C	110	88.00
				F1AE0481D	120	88.00
				F1AE0481N	127	88.00
				F1AE0481A	96	88.00
JR-807-11	FREEMONT 2011/... - DODGE: JOURNEY 2012/... - JEEP: COMPASS 2010/...		2360cc.	ED3 16V	170/175	88.00
			2360cc.	EDG 16V	170/175	88.00
SJ-501	NUOVO DUCATO 1989/94 - DUCATO 1994/... - IVECO: DAILY 30.8 - 35.8 1996/... RENAULT: MASTER 1990/... - TRAFIC 1990/... SERIE 742/748/770/772/758/780/782 (INY. INDIRECTA)		2445cc.	8140.67	55	93.00
			2499cc.	8140.67X230	85	93.00
			2499cc.	8140.67F37	82	93.00
			2499cc.	S8U	57/75/80	93.00
SJ-550	DUCATO TD 1990/94 - DUCATO TDS 1994/96 - DUCATO TDSE 1996/... IVECO: DAILY TURBO 1990/...		2499cc.	8140.27/S	103	93.00
			2499cc.	8140.47/R/S	110/116	93.00
			2499cc.	8140.47.X30	116	93.00
SJ-450	DUCATO 14TDS - DUCATO MAXI 18TDS 1996/... - IVECO: TURBO DAILY 3010 3510 - 4010 - 4510 - 4910 - 3512 - 4012 - 4512 - 4912 - 5912 1996/... RENAULT: MASTER TD 1998/...		2799cc.	8140.23	99	94.40
			2799cc.	8140.43	122	94.40
			2799cc.	S9W 700/702	115	94.40
SJ-526	DUCATO 14 - DUCATO 18 MAXI - DUCATO 14D - DUCATO 18D MAXI 1998/... IVECO: DAILY 30.8 - 35.8 1996/...		2799cc.	8140.63 Inyección Indirecta	87/89	94.40
SJ-598	DUCATO JTD MULTIJET 2006/... - IVECO: DAILY III/V 2006/... CITROEN: JUMPER III HDI 2008/... - PEUGEOT: BOXER MANAGER HDI 2006/...		2999cc.	F1CE0481/A/D (30DT)	136/156	95.80
				F30DT/FG30DT 16V	156	94.40
JR-329-20	FIAT: EXCAVADORA FB80 - AGRALE: TRACTOR 5075.4 - 5085.4/5 - BX6110 - 88 FORD: F100 1993/95 - F1000 1994/96 F4000 1992/93 - F2000 1980/... - FB4000 1985/... - VALMET: 78/88/880/980 4X4 - VOLKSWAGEN: 6.90/7.90/7.110 (922900134317/1997/3237/2338)		3922cc.	D229-4	96	102.00

FORD

REF.	MODELO / MODEL		Cm ³	MOTOR / ENGINE	HP	Ø Pist. PAG.
JR-490-15	ESCORT 1.3 1983/... - ESCORT HOBBY 1.0 1993/... - VOLKSWAGEN: GOL 1993/...		997cc.	CHT/AE		70.30
			1300cc.	CHT/AE		71.50
JR-758-07	KA - KA+ - FIESTA 2014/...		998cc.	M1DA TiVCT 12V Ecoboost	100	71.90
JR-388	KA - FIESTA - COURIER - ESCORT - ECOSPORT 8V 1999/...		999cc.	Zetec Rocam ZL	65/95	68.69

FORD - Continuación...						
REF.	MODELO / MODEL	cm ³	MOTOR / ENGINE	HP	Ø Pist.	PAG.
JR-523-15	KA 1997/99 - FIESTA 1996/99 53 HP - FIESTA 1988/95 45 HP	999cc.	OHV (HCS) Endura	45/53	68.70	141
JR-565	FIESTA 2003/... - ECOSPORT 2003/...	999cc.	Zetec Rocam Supercharger	98	68.70	142
JR-356-15	COURIER 1991/... - FIESTA 1988/95 - FIESTA - KA (CÁRTER DE ACERO) (CÁRTER DE ALUMINIO 1995/...)	1297cc. 1299cc.	OHV (HCS) Endura	60 50/60	73.96 73.96	143
JR-316-15	CORCEL 1971/77 - CORCEL II 1978/83 - BELINA - COUPE GT 1.4 BR	1300cc. 1400cc.	CHT CHT	73 73	77.00 77.00	144
JR-535-15	COURIER - FIESTA SE - PUMA 1996/... - FOCUS 1998/...	1388cc.	Zetec SE 16V	90/75	76.00	145
SJ-542	FIESTA - ECOSPORT TD 2003/... - DURATORQ TDCI 1996/98 - FUSION TDCI 2001/... - CITROEN: C3 - C2 HDI - C1 - XSARA HDI 2002/... PEUGEOT: 107 - 206 - 307 - 1007 - BIPPER HDI 2001/...	<i>Diesel</i> 1398cc. 1398cc. 1398cc. 1398cc.	F6JA - F6JB DV4TD(8HX) DV4TD(8HZ) (SOHC) 8V Duratorq	68 54/70 68 68	73.70 73.70 73.70 73.70	146
JR-308-15	CORCEL II 1979/83 - SCALA 1983/... - PAMPA 1982/83 - DEL REY 1981/83 BELINA II	1555cc.	CHT	73	77.00	147
JR-339-15	ESCORT L/GL/GHIA - CORCEL II - SCALA - PAMPA 1983/... - DEL REY - VERONA 1989/... - BELINA II - VOLKSWAGEN: SAVEIRO - GOL - VOYAGE - LOGUS 1989	1555cc. 1555cc.	CHT AE	73 73	77.00 77.00	148
SJ-541	C-MAX - FOCUS - FUSION TDCI 16V 2003/... - CITROEN: XSARA - PICASSO JUMPY - BERLINGO 1999/... - C2 - C3 - C4 - C5 TD 16V - PEUGEOT: 307 HDI 2004/... - 407 TD 2004/... - 206 - 207 COMPACT - 1007 2003/... VOLVO: S40 - V50 - C30 2005/...	<i>Diesel</i> 1560cc. 1560cc. 1560cc. 1560cc.	DV6TED4 DV6TD4(9HZ) DV6TED4(9HZ) G8DA - Duratorq (DOHC) 16V	75/109 108 104 90/109	75.00 75.00 75.00 75.00	149
JR-326-15	ESCORT - ORION - SCALA - PAMPA - BELINA - VOLKSWAGEN: GACEL - SENDA VOYAGE - SANTANA - GOL - PASSAT - POLO CLASSIC - FOX - POINTER - LUPO DERBY - CARAT - GOLF	1595cc. 1781cc.	AP AP	70 85/87	81.00 81.00	375
JR-557	FOCUS 2004/... - FIESTA FUSION 2003/... - C-MAX 2007/... VOLVO: C30 S40 V50 2005/...	1596cc. 1596cc. 1596cc. 1596cc.	L4 Sigma (16V DOHC) FYJA/B/C (16V DOHC) HWDA/B (16V DOHC) SHDA/B/C B4164S3	100 100 100 101	79.00 79.00 79.00 79.00	150
JR-696	NEW FIESTA - ECOSPORT 2013/... - FOCUS - MONDEO 2007/...	1596cc.	Zetec-S Sigma (16HDEZ)	100	79.00	151
JR-296-15	SIERRA L/GL 1984/...	1597cc.	OHC	75	81.30	152
JR-389	COURIER - KA 1997/... - FIESTA 1999/... - FIESTA IKON 2000/... ESCORT 2000/... - ECOSPORT 8V 2003/...	1598cc.	Zetec Rocam ZL	95/98	82.00	153
SJ-265	COURIER - FIESTA - ESCORT - MONDEO - ORION D - SIERRA TD MONDEO TD 1991/... - ESCORT TDI 1994/...	<i>Diesel</i> 1753cc. 1753cc.	D18 D18 T/TI	60/75 75/90	82.50 82.50	154
SJ-379	TRANSIT TDI/TDCI 2002/... - FOCUS TDDI/TDCI/DI - FIESTA TDDI 2000/...	<i>Diesel</i> 1753cc. 1753cc. 1753cc. 1753cc.	BHPA/BHPB LYNX (C9DC) Duratorq BHDA/BHDB	75/90 75/90 115 75	82.50 82.50 82.50 82.50	155
JR-390-15	ESCORT - FIESTA/XR2 - ORION - MONDEO - ESCORT XR3I 1992/...	1796cc.	Zetec 16V	105/115	80.60	156
JR-392-15	MONDEO 1993/...	1796cc.	Zetec 16V (DOHC)	115	80.60	157
JR-695-15	FOCUS 1998/04 - TRANSIT 2002/...	1796cc.	Zetec-E (DOHC) 16V	116	80.60	158
JR-360-15	GALAXY - VERSAILLES - VERONA - ESCORT 92/96 - VOLKSWAGEN: CARAT QUANTUM - POINTER - GOL - GOLF - SANTANA 1989/...	1984cc.	Audi 827 AP	107/115	82.50	159
JR-391-15	ESCORT - FIESTA - ORION - MONDEO	1989cc.	Zetec 16V	136	84.80	160
JR-393-15	MONDEO 1993/01	1989cc.	Zetec 16V (DOHC)	136	84.80	161
JR-566-15	FOCUS 1992/02 - MAVERICK 2000/... - COUGAR 1999/...	1989cc. 1989cc. 1989cc.	YF EDBA/EDBB EDBC/EDBD	124 124 131	84.80 84.80 84.80	162
JR-274-15	TAUNUS L 1974/81 - GXL - GHIA 1974/...	1990cc.	OHC	63	89.32	163
SJ-230	SCORPIO TDI - GRANADA TDI - FALCON 1988/... - ALFA ROMEO: 75/90TD 1983/... - 155/164TD 1993/... - BORGWARD: VM TURBO - CHRYSLER: VOYAGER GRAND VOYAGER 1992/94 - ROVER: RANGE ROVER TD 1986/89 TOYOTA: LANDCRUISER 70/250 TD 1987/93	<i>Diesel</i> 1995cc. 2393cc. 2499cc.	VM80A HR 492 494 TD / HR425	95 110/113 114/125	88.00 92.00 92.00	27
SJ-572	FOCUS - C-MAX TDCI 2003/... - CITROEN: EVASION 2000/... - C5/C8 2001/... JUMPY 2002/...HDI - LANCIA: PHEDRA JTD - ZETA JTD 2000/... PEUGEOT: 406/607/806/807 HDI 2000/... - EXPERT HDI 1999/...	<i>Diesel</i> 1997cc. 1997cc. 1998cc. 2179cc.	DW10ATED4 DW10JATED4 G6DA/G6DC DW12TED4 (DOHC)	109 110 135 130/133	85.00 85.00 85.00 85.00	292
JR-362-15	MONDEO 2001/... - ECOSPORT 2003/... - FOCUS 2000/... MAZDA: 3 2003/... - 5 2005/... (T. VÁLVULAS PLÁSTICA)	1999cc. 1999cc. 1999cc.	CJBA/B AOBA/C LF/LH Duratec HE 16V	143/145 145 104	87.50 87.50 87.50	164

FORD - Continuación...							
REF.	MODELO / MODEL		Cm ³	MOTOR / ENGINE	HP	Ø Pist. PAG.	
JR-363-15	MONDEO 2001/... - ECOSPORT 2003/... - FOCUS 2000/... MAZDA: 3 2003/... - 5 2005/... (T. VÁLVULAS DE ALUMINIO)		1999cc. 1999cc. 1999cc.	CJBA/B AOBA/C LF/LH Duratec HE 16V	143/145 145 104	87.50 87.50 87.50	165
JR-809-11	MONDEO IV 2010/... - S-MAX 2010/...		1999cc. 1999cc. 1999cc. 1999cc.	TNBA TNWA/TNWB TPBA TPWA	203 199/203 240 240	87.50 87.50 87.50 87.50	166
JR-810-11	FOCUS III 2013/...		1999cc. 1999cc.	MGDA XQDA	170 150	87.50 87.50	167
JR-154-05	A - AA 1928/31		2100cc. 3286cc.	Autos (3 7/8 x 4 1/2)	24 24	98.40 98.40	168
SJ-560	RANGER XL 4X2/4X4 TDCI TRANSIT TDCI 2006/... - CITROEN: JUMPER HDI 2006/... FIAT: DUCATO 2006/... - PEUGEOT: BOXER HDI 2006/...	<i>Diesel</i>	2198cc. 2198cc.	Puma TDCi eTGV 4HU/4HV (P22DTE) (DOHC) 16V	123 101/120	86.00 86.00	169
JR-780	RANGER 2001/... - ECOSPORT 2003/... - MONDEO 2002/...		2261cc.	Duratec L3 IVC 16V	141	87.50	170
JR-250-15	TAUNUS - SIERRA - XR4 - GXL/GT - SP/GHIA - COUPE 1974/81 MUSTANG 1980/... MAVERICK 1975/79 - FALCON 1974/...		2299cc.	OHC	100/114	96.00	171
SJ-476	BRONCO II TD - RANGER 2WD 1985/... - CHRYSLER: PICK UP POWER RAM 50 TD 1983/85 - HYUNDAI: H100 - H1 D/TD 1986/... - GALLOPER - LIBERTO 1998/... MITSUBISHI: L200 1987/... - CANTER - T35 - PAJERO - MONTERO 1986... (MD972160)	<i>Diesel</i>	2346cc. 2476cc. 2476cc. 2607cc.	4D55T 4D56 D4BA - X/D4BH D4BB	67/84 70/84 75/100 85	91.00 91.00 91.10 91.10	243
SJ-567	TRANSIT TD 2000/...	<i>Diesel</i>	2402cc.	Duratorq 16V	120/125	89.90	172
JR-811-11	RANGER 2001/12 - ECOSPORT 2003/07 - MONDEO 2002/06 (9E5Z6079B/9E5Z6E078A)		2488cc. 2488cc. 2488cc. 2488cc.	GBVAF GBVAL GBVAK EV2GD Duratec	166 166 166 166	89.00 89.00 89.00 89.00	173
SJ-272	RANGER TDI 1995/... - RANGER TD BR 2000-2002/... - CHEVROLET: BLAZER TDI S10 TDI 1995/... - M. BENZ: SPRINTER TDI 1997/... - ROVER: RANGE ROVER DISCOVERY - DEFENDER TDI 1990/...	<i>Diesel</i>	2495cc. 2507cc. 2758cc.	200 - 300 TDI Power Stroke	107/112 95 135	90.50 90.70 93.00	231
SJ-273	TRANSIT - TRANSIT D/DI 1985/99 - TOURNEO D/TD 1994/99	<i>Diesel</i>	2496cc. 2496cc. 2496cc. 2496cc.	4EB/BC/CA/FB/CC/FA/FC/FD 4HC/EA/HB/HC/EB/EC 4CB 4GA/GB/GC/FC/GB/GE/GD	70/80 76/100 70 70/85	93.64 93.64 93.64 93.64	174
SJ-527	MAVERICK TD 1992/99 - NISSAN: TERRANO D 1986/... - TERRANO TD 1989/92 ATHFINDER D - TRUCK D21 (1010143G27)	<i>Diesel</i>	2663cc.	TD27 - TD27T	85/100	96.00	254
JR-161-15	FALCON 4B - STD - DE LUXE - FUTURA - RURAL 1962/68		2780cc. 3052cc.	170 4B 187 4B	84 96	88.90 90.42	175
JR-812-11	FUSION 2009/12 - MAVERICK 2001/... - MONDEO (9L8Z6079B)		2967cc. 2967cc. 2967cc.	Duratec V6 24V AJ MEBA	197/226 197 226	89.00 89.00	176
SJ-524	RANGER 3.0 16V 4X4 - FULL BR INTERCOOLER 10/2007/...	<i>Diesel</i>	2968cc.	Maxion TD (SOCH) Power stroke	163	96.00	232
SJ-525	RANGER 3.0 16V 4X4 - FULL BR INTERCOOLER 2005...10/2007	<i>Diesel</i>	2968cc.	Maxion TD (SOCH) Power stroke	163	96.00	233
JR-164-15	FALCON 7B - F100 - FAIRLANE 1969/...		3052cc. 3075cc. 3618cc.	187 7B 188 7B 221 7B	108 108 108	90.62 93.47 93.47	177
SJ-561	RANGER XLS/XLT 4X2/4X4 TDCI 2013/...	<i>Diesel</i>	3198cc.	Puma TDCi eTGV	200	90.00	178
JR-328	FORD: F100	<i>Diesel</i>	3336cc.	4.203 Potenciado	71	91.44	259
JR-190	F100 - PICK UP - FALCON 1970/... - DODGE: POLARA - D100 - D200 1987/... JEEP: T1000 1969/80	<i>Diesel</i>	3336cc.	4.203 - P4 - 192Z	71	91.49	258
JR-813-11	EDGE SEL 2009/16 - EXPLORER 2011/18		3496cc.	213 CID	269	92.50	179
JR-268-15	FALCON SP - SPRINT 7B 1973/...		3618cc.	221 Sprint SP 7B	132	93.47	180
JR-337-15	FALCON GL - PICK UP F100 1989/...		3618cc.	Max Econo 7B	106	93.47	181
JR-329-20	F100 1993/95 - F1000 1994/96 - F4000 1992/93 - F2000 1980/... - FB4000 1985/... AGRALE: TRACTOR 5075.4 - 5085.4/5 - BX6110 - 88 - FIAT: EXCAVADORA FB80 VALMET: 78/88/880/980 4X4 - VOLKSWAGEN: 6.90/7.90/7.110 (922900134317/1997/3237/2338)	<i>Diesel</i>	3922cc.	D229-4	96	102.00	229
SJ-348	F100 GMC TURBO 1999/... - CHEVROLET: GM SILVERADO 3500HD/DLX 1997/... GM GRAND BLAZER 1998/...	<i>Diesel</i>	4200cc. 4200cc.	Sprint 6.07 TD Turb. Intercooler	167 198	93.00 93.00	230
JR-166-15	F100 - 350 - 600 - FAIRLANE 1961/70 - FASE I		4458cc. 4785cc.	272 - V8 Fase I 292 - V8 Fase I	170 170	92.00 95.25	182
JR-259-15	F100 - 350 - 600 - FAIRLANE 1/8 - LTD 500 - FASE II 1969/76		4785cc.	V8 Fase II	180	95.25	183
JR-476-15	F100 - 150 1991/...		4900cc.	300 CID Inyección	145	101.60	184

FORD - Continuación...							
REF.	MODELO / MODEL		Cm ³	MOTOR / ENGINE	HP	Ø Pist.	PAG.
JR-153-05	T 1926/27						185
HAFEI							
REF.	MODELO / MODEL		Cm ³	MOTOR / ENGINE	HP	Ø Pist.	PAG.
JR-737	TOWNER JR. - YRV JR.		970cc.	CD 8V	48	65.50	186
HONDA							
REF.	MODELO / MODEL		Cm ³	MOTOR / ENGINE	HP	Ø Pist.	PAG.
JR-350-15	FIT 2003/... - CITY 2004/... - JAZZ 2005/...		1339cc. 1339cc.	L13A3/L13A5 8V I-DSI-TWIN SPARK	82/88	73.00 73.00	187
JR-687-07	CIVIC 1987/... - CRX 1988/... (06110P03000)		1343cc. 1493cc. 1590cc. 1590cc.	D13B1/2 D15B1/2/3/4/7/8 D16A1/6/7/9 D16Z1/2	75 70/84/94/98 107/115 106/110	75.00 75.00 75.00 75.00	188
JR-814-11	CIVIC 2015/...		1490cc.	L15B8	120	73.00	189
JR-351-15	CITY 2007/... - CITY ZX 2007/... - JAZZ 2006/...		1497cc.	L15A VTEC 16V	81/107	73.00	190
JR-740-07	CIVIC VI VTEC 2005/... - CIVIC VII VTEC 2005/09 ACCORD TOURER 2009/... CRV 2009/...		1586cc. 1798cc. 1998cc.	R16A1/2 16V R18A1/2 16V R20A1/3 16V	114 140 150/156	76.00 81.00 81.00	191
JR-460-07	CIVIC VTEC 16V - CIVIC DEL SOL VTEC 16V - CRX VTEC 16V - CIVIC COUPE VTEC		1590cc.	D16Z 6/7/9	125	75.00	192
JR-739-07	CIVIC VT VTEC 1991/00 - CIVIC SI VTEC 1999/00 - CRX VT VTEC 1992/00		1595cc.	B16A1/2/3 16V	160	81.00	193
JR-815-11	CIVIC VII 2005/12 - CRV III 2007/...		1595cc. 1799cc. 1997cc.	R16A1 16V R18A1/2 16V R20A1/2/3 16V	114 132/140 150/155	81.00 81.00 81.00	194
JR-738-11	CIVIC 1997/05 - CIVIC COUPE 2001/... - STREAM 2001/... (06110PLC010)		1668cc. 1668cc.	D17A2/9 D17Z1	116/120 118	75.00 75.00	195
JR-685-07	ACCORD - PRELUDE 1979/83		1751cc.	EK1	69	77.00	196
JR-688-11	ACCORD 1989/98 - PRELUDE 1992/96 (06110PT5000/010)		1849cc.	F18A	105	85.00	197
JR-686-11	PRELUDE CRV 1997/00 (06110P8R004)		1972cc.	B20B	125	84.00	198
JR-666-11	CIVIC 1997/01 ACCORD 1996/98 - ROVER: 420 620 220 1994/00 25 45 2000/05	<i>Diesel</i>	1994cc. 1994cc.	20T2N 20T2R	101 86	84.50 84.50	334
HYUNDAI							
REF.	MODELO / MODEL		Cm ³	MOTOR / ENGINE	HP	Ø Pist.	PAG.
JR-816-11	I10 2012/... EON 2013/... - KIA: PICANTO 2011/...		998cc.	G3LA	67/69	71.00	199
JR-817-11	I20 - I30 - KIA: RIO		998cc.	G3LC	101	71.00	200
JR-568-15	HB20 2012/... - KIA: PICANTO 2011/...		998cc.	Kappa 12V	80/98	71.00	201
JR-684-07	ATOS 1998/03 - SANTRO 1997/... (2091002B00)		999cc.	G4HC	54	66.00	202
JR-818-11	ATOS PRIME 2005/08 - GETZ 2005/08 - SANTRO 2005/08 - PICANTO 2004/12		1086cc.	G4HG	61/65	67.00	203
JR-741-07	HB20 2006/... - I20 2009/... - I30 2010/... - ELANTRA 2006/... VELOSTER 2013/... KIA: SOUL 2009/... - CERATO 2010/...		1591cc.	G4FC Gamma	126	77.00	204
JR-683-07	ELANTRA 1990/95 - LANTRA 1990/95 (2091033A10)		1596cc. 1836cc.	G4CR G4CN	106 127	82.30 81.50	205
SJ-259	LANTRA 1998/... - CITROEN: XANTIA TD - ZX TD 1993/... - BX 17TD 1988/92 C15 1994/... - BERLINGO 1996/99 - XSARA 1997/... - FIAT: DUCATO TD 1994/... LADA: NIVA 2121 - ALEKO 1990/... - PEUGEOT: 205 - 305 - 306 - 309 - 405 - 406 806 TD - EXPERT T/TD - PARTNER - BOXER TD 1992/... - ROVER: 218 - 418 T/TD 67HP 1991/96 - SUZUKI: VITARA 68HP 1995/96	<i>Diesel</i>	1769cc. 1769cc. 1905cc. 1905cc.	XUD7 161A/A9A XUD7 T-TE XUD9 XUD9 TE-TF GRD	60 78/90 65/69 90/92	80.00 80.00 83.00 83.00	281
JR-682-11	TUCSON HDI ELANTRA SANTA FE 2000/06 (2091027A00)		1991cc.	D4EA	113	83.00	206
JR-820-11	SONATA 2007/... - KIA: RONDO 2006/... - MAGENTIS 2005/...		1998cc.	G4KA	100/106	86.00	207
SJ-476	H100 - H1 D/TD 1986/... - GALLOPER - LIBERTO 1998/... - CHRYSLER: PICK UP POWER RAM 50 TD 1983/85 - FORD: BRONCO II TD - RANGER 2WD 1985/... MITSUBISHI: L200 1987/... - CANTER - T35 - PAJERO - MONTERO 1986... (MD972160)	<i>Diesel</i>	2346cc. 2476cc. 2476cc. 2607cc.	4D55T 4D56 D4BA - X/D4BH D4BB	67/84 70/84 75/100 85	91.00 91.00 91.10 91.10	243
JR-821-11	SANTA FE - IX35 - TUCSON 2009/... - SONATA 2007/... - KIA: SORENTO RONDO 2009/... - SPORTAGE 2011/...		2359cc.	G4KE	177	88.00	208
SJ-488	H100 - HR 8V 2008/11 - MITSUBISHI: L200 1987/... - L300 - CANTER - T35 PAJERO - MONTERO 1986/...	<i>Diesel</i>	2476cc. 2476cc.	D4B/H 4D56T	115/130 115	91.00 91.00	209
JR-569-11	HR 2013/... - KIA: SORENTO 2007/... - BONGO 2013/...	<i>Diesel</i>	2497cc.	D4CB	130	91.00	210
JR-764-07	SONATA - MITSUBISHI: MONTERO - GALANT V6 12V		2972cc.	6G72 12V	140	91.10	246
ISUZU							
REF.	MODELO / MODEL		Cm ³	MOTOR / ENGINE	HP	Ø Pist.	PAG.
JR-122-15	AMIGO - TROOPER II - IMPULSE - ASKA - CHEVROLET: LUV - PICK UP 1986/95 OPEL: BRAVA - CAMPO (5878120663)		2254cc.	4ZD1	88/96	89.30	74
JR-723-11	CAMPO 1983/90 - TROOPER 1988/... (5878102892/4572)	<i>Diesel</i>	2499cc.	4JA1	76	93.00	211
JR-725-11	D-MAX D/DT 2007/... - RODEO 2005/... (5878153592)	<i>Diesel</i>	2499cc. 2997cc.	4JK1-TC 4JJ1-TC	136 160	95.40 95.40	212

ISUZU - Continuación...						
REF.	MODELO / MODEL		Cm ³	MOTOR / ENGINE	HP	Ø Pist. PAG.
JR-726-11	D-MAX DITD (8DH) 2002/...(5878143163)		Diesel 2997cc.	4JH1-TC	131	95.40 213
JR-680-11	TROOPER 1992/... - ELF 1993/... - CAMPO 1991/... (5878129040)		Diesel 3059cc. 3059cc.	4JG2 4JG2T	82 109	95.40 95.40 214

IVECO						
REF.	MODELO / MODEL		Cm ³	MOTOR / ENGINE	HP	Ø Pist. PAG.
SJ-595	DAILY III 16V 2002/... FIAT: DUCATO JTD MULTIJET 16V 2002/... (504049360)		Diesel 2286cc. 2286cc. 2286cc. 2286cc.	F1AE0481C F1AE0481D F1AE0481N F1AE0481A	110 120 127 96	88.00 88.00 88.00 88.00 131
SJ-501	DAILY 30.8 - 35.8 1996/... FIAT: NUOVO DUCATO 1989/94 - DUCATO 1994/... RENAULT: MASTER 1990/... - TRAFIC 1990/... SERIE 742/748/770/772/758/ 780/782 (INY. INDIRECTA)		Diesel 2445cc. 2499cc. 2499cc. 2499cc.	8140.67 8140.67X230 8140.67F37 S8U	55 85 82 57/75/80	93.00 93.00 93.00 93.00 133
SJ-550	DAILY TURBO 1990/... - FIAT: DUCATO TD 1990/94 - DUCATO TDS 1994/96 DUCATO TDSE 1996/...		Diesel 2499cc. 2499cc. 2499cc.	8140.27/S 8140.47/R/S 8140.47.X30	103 110/116 116	93.00 93.00 93.00 134
SJ-450	TURBO DAILY 3010 - 3510 - 4010 - 4510 - 4910 - 3512 - 4012 - 4512 - 4912 5912 1996/... - FIAT: DUCATO 14TDS - DUCATO MAXI 18TDS 1996/... RENAULT: MASTER TD 1998/... -		Diesel 2799cc. 2799cc. 2799cc.	8140.23 8140.43 S9W 700/702	99 122 115	94.40 94.40 94.40 135
SJ-526	DAILY 30.8 - 35.8 1996/... - FIAT: DUCATO 14 - DUCATO 18 MAXI - DUCATO 14D DUCATO 18D MAXI 1998/... -		Diesel 2799cc.	8140.63 Inyección Indirecta	87/89	94.40 136
SJ-598	DAILY III/V 2006/... - FIAT: DUCATO JTD MULTIJET 2006/... CITROEN: JUMPER III HDI 2008/... - PEUGEOT: BOXER MANAGER HDI 2006/...		Diesel 2999cc.	F1CE0481/A/D (30DT) F30DT/FG30DT 16V	136/156 156	95.80 94.40 137

JEEP						
REF.	MODELO / MODEL		Cm ³	MOTOR / ENGINE	HP	Ø Pist. PAG.
JR-286-15	WRANGLER 83/86 - CITROEN: CX - ATHENS RENAULT: R18 LX/TS/TX/XE/GTX/GTII - R21 TXE - TRAFIC 1989/... MASTER 1981/93 - ESPACE 1984/97 - FUEGO GTX/GTXII/GTA 1981/86		1995cc. 2165cc.	829-J5R/6R/7R 851-J7T	80/102 120	88.00 88.00 327
SJ-249	JEEP WAGONEER TD 1984/95 - COMANCHE TD 1986/88 - RENAULT: R18 1981/86 R21 1984/97 - FUEGO - ESPACE - TRAFIC 1981/97 - MASTER 1980/... - R20 - R25 R30 - CHEVROLET: SPACEVAN - TRAFIC		Diesel 2068cc. 2068cc.	852/J8S 121	60/86 80	86.00 86.00 330
JR-176-05	WILLYS - CPW UNIVERSAL - RASTROJERO - 4 - 63 - 2WD - 4WD 1940/74 GUERRERO 1941/43		2199cc.	CJ2A - CJ3A DJ3A	52	79.38 215
JR-808-11	RENEGADE 2014/... CHEROKEE 2013/... (68191818AA)		2360cc.	ED6	175/180	88.00 216
JR-807-11	COMPASS 2010/... - FIAT: FREEMONT 2011/... - DODGE: JOURNEY 2012/...		2360cc. 2360cc.	ED3 16V EDG 16V	170/175 170/175	88.00 88.00 132
JR-178-05	JEEP IKA CONTINENTAL - BERGANTIN 1954/78 (2090523)		2470cc.	4L - 151	80	84.14 217
SJ-779	CHEROKEE - LIBERTY - WRANGLER - CHEVROLET: TRAILBLAZER 2012/... S10 2012/...		Diesel 2768cc.	ENS 16V	150	94.00 80
JR-190	T1000 1969/80 - FORD: F100 - PICK UP - FALCON 1970/... DODGE: POLARA D100 - D200 1987/...		Diesel 3336cc.	4.203 - P4 - 192Z	71	91.49 258

KIA						
REF.	MODELO / MODEL		Cm ³	MOTOR / ENGINE	HP	Ø Pist. PAG.
JR-816-11	PICANTO 2011/... - HYUNDAI: I10 2012/... EON 2013/...		998cc.	G3LA	67/69	71.00 199
JR-817-11	RIO - HYUNDAI: I20 - I30		998cc.	G3LC	101	71.00 200
JR-568-15	PICANTO 2011/... - HYUNDAI: HB20 2012/...		998cc.	Kappa 12V	80/98	71.00 201
JR-741-07	SOUL 2009/... - CERATO 2010/... - HYUNDAI: HB20 2006/... - I20 2009/... I30 2010/... - ELANTRA 2006/... - VELOSTER 2013/...		1591cc.	G4FC Gamma	126	77.00 204
JR-820-11	RONDO 2006/... - MAGENTIS 2005/... - HYUNDAI: SONATA 2007/...		1998cc.	G4KA	100/106	86.00 207
JR-345-20	SPORTAGE TD 1996/... - MAZDA: 626TD 1993/97 - 323D 1998/...		Diesel 1998cc. 1998cc.	RF RF - CX	83 75/82	86.00 86.00 218
JR-821-11	SORENTO - RONDO 2009/... - SPORTAGE 2011/... - HYUNDAI: SANTA FE - IX35 TUCSON 2009/... - SONATA 2007/...		2359cc.	G4KE	177	88.00 208
JR-569-11	SORENTO 2007/... - BONGO 2013/... - HYUNDAI: HR 2013/...		Diesel 2497cc.	D4CB	130	91.00 210
JR-544-07	BESTA GS 1998 (SOHC) - K2700 - BONGO - PREGIO		Diesel 2665cc.	J2	78/83	94.50 219
JR-748-07	BESTA GS/GRAND 2000/05 - PREGIO		Diesel 2956cc.	JT/JTA 8V	85	98.00 220

LADA						
REF.	MODELO / MODEL		Cm ³	MOTOR / ENGINE	HP	Ø Pist. PAG.
JR-447-15	LAICA - NIVA - 2101 - 2102 1970/... - 2103 - 2107 1972/... (21011004024)		1198cc. 1452cc.	OHC OHC	60 75	76.00 76.00 221
SJ-259	NIVA 2121 - ALEKO 1990/... - CITROEN: XANTIA TD - ZX TD 1993/... - BX 17TD 1988/92 - C15 1994/... - BERLINGO 1996/99 - XSARA 1997/... - FIAT: DUCATO TD 1994/... - HYUNDAI: LANTRA 1998/... - PEUGEOT: 205 - 305 - 306 - 309 - 405 406 - 806 TD - EXPERT T/TD - PARTNER - BOXER TD 1992/... ROVER: 218 - 418 T/TD 67HP 1991/96 - SUZUKI: VITARA 68HP 1995/96		Diesel 1769cc. 1769cc. 1905cc. 1905cc.	XUD7 161A/A9A XUD7 T-TE XUD9 XUD9 TE-TF GRD	60 78/90 65/69 90/92	80.00 80.00 83.00 83.00 281

LANCIA							
REF.	MODELO / MODEL		cm ³	MOTOR / ENGINE	HP	Ø Pist.	PAG.
JR-493	YPSILON 2000/... - FIAT: PALIO - SIENA - PALIO NOVO - DOBLO - PALIO WEEKEND - NOVO SIENA - BRAVA - ALBEA - BRAVO - STILO 16V 2000/...		999cc.	Fire 16V-1714130	70	70.00	104
			1242cc.	Fire 16V	80	71.00	
			1242cc.	188 A5000	60	70.80	
JR-230-15	DELTA - PRISMA 1978/83 - FIAT: 128 1971/81 - RITMO - SPAZIO - STRADA 78/85 EUROPA - 147 - FIORINO - RITMO - UNO 70 - REGATTA - DUNA (1041194)		1290cc.	128A1	73	86.40	110
			1301cc.	138B2	68/70	86.40	
			1301cc.	831B	75/80	86.40	
			1498cc.	138A/A2/A4	75/85	86.40	
JR-294-15	DELTA - PRISMA 1986/... - FIAT: 128 - REGATTA - DUNA - RITMO 1986/90 ELBA - PREMIO - FIORINO - UNO - S.EUROPA 1983/... (1041254)		1498cc.	138C3	75/85	86.40	116
			1498cc.	831B1	82/85	86.40	
JR-341-15	DEDRA 1989/93 - FIAT: DUNA - UNO - REGATTA - PALIO - SIENA - ELBA PREMIO - TIPO - FIORINO 1988/... - PUNTO - TEMPRA (7604404/7564332)		1581cc.	Sevel	84/88	86.40	118
			1581cc.	146C6	75	86.40	
			1581cc.	159A3	76/86	86.40	
			1581cc.	160A2 - 835A	80/82/90	86.40	
JR-382-15	DELTA - DEDRA - LYBRA 1996/... - FIAT: PALIO - SIENA - TIPO 1,6 - BRAVO MAREA - TORQUE 16V - STRADA - BRAVA - MULTIPLA 1999/...		1581cc.	178B	103	86.40	119
			1581cc.	182A4	103	86.40	
			1581cc.	182A6	90/103	86.40	
			1581cc.	185A3	103	86.40	
			1581cc.	186A4	103	86.40	
JR-295-15	BETA - TREVI - PRISMA - DELTA 1982/84 - FIAT: ARGENTA - RITMO - REGATTA 100S 1985/... - STRADA - 131 SUPER MIRAFIORI - 124 1972/78 - 132 1977/85		1585cc.	149A	100	84.00	122
			1585cc.	138 ARO/2ACT	98/105	84.00	
			1756cc.	132 A70	105/118	84.00	
			1995cc.	132 C2	113/115	84.00	
JR-358-15	DELTA HF TURBO - DEDRA INTEGRALE - PRISMA - THEMA IE - FIAT: REGATTA 100 - 2000 - TEMPRA 1989/... - BIALBERO 8V - TIPO IE - RITMO 100 - CROMA IE		1585cc.	149 A4048	83/100	84.00	123
			1585cc.	831B 6000	90/96	84.00	
			1995cc.	835A 7000	169/180	84.00	
			1995cc.	154C A1000	90/110	84.00	
SJ-246	DELTA - DEDRA 1994/99 - FIAT: FIORINO - DUCATO - UNO - TIPO - PALIO - DUNA TEMPRA - REGATTA - SIENA TD - ALFA ROMEO: 145/146 - 155 TD 1993/99	<i>Diesel</i>	1697cc.	149B	58	82.60	125
			1697cc.	176A	69/71	82.60	
			1929cc.	160D-280A1	65	82.60	
			1929cc.	675.01-336.01	90	82.60	
JR-354-15	DELTA INTEGRALE 1986/92 - THEMA TURBO 16V - DEDRA IE - KAPPA ALFA ROMEO: 155 TURBO 16V - FIAT: TEMPRA IE 16V - TIPO IE 16V CROMA IE 16V 1990/96 - COUPE IE 16V (7076950)		1756cc.	160 A5000	138	84.00	127
			1995cc.	836 A3000/11	142	84.00	
			1995cc.	834 C1246/2 - Zact 16V	126/145/180	84.00	
			1995cc.	154E1000/27/160A8046	140/145	84.00	
JR-357-15	THEMA IE 1985/92 - FIAT: CROMA IE TURBO 1991/96 - TIPO IE - TEMPRA IE 1990/95 (7096175)		1995cc.	154 C4000/46	153/155	84.00	129
			1995cc.	159 A6096/11	115	84.00	
			1995cc.	834 B146	115/120	84.00	
			1995cc.	Zact 8V	120/153	84.00	
SJ-572	PHEDRA JTD - ZETA JTD 2000/... - CITROEN: EVASION 2000/... - C5/C8 2001/... JUMPY 2002/...HDI - FORD: FOCUS - C-MAX TDCI 2003/... PEUGEOT: 406/607/806/807 HDI 2000/... - EXPERT HDI 1999/...	<i>Diesel</i>	1997cc.	DW10ATED4	109	85.00	292
			1997cc.	DW10JATED4	110	85.00	
			1998cc.	G6DA/G6DC	135	85.00	
			2179cc.	DW12TED4 (DOHC)	130/133	85.00	
JR-527-15	KAPPA - LIBRA 1996/00 - FIAT: MAREA 1996/98 182 A1- COUPE 1996/2001 BRAVO 1995/98 - MAREA 1998/... 182 E		1998cc.	182A1	147	82.00	130
			1998cc.	838A1/A6	145/155	82.00	
			1998cc.	182B3/B7	147/155	82.00	

M. BENZ							
REF.	MODELO / MODEL		cm ³	MOTOR / ENGINE	HP	Ø Pist.	PAG.
JR-677-11	A160 1997/04 A140 Vaneo 2001/...		1598cc.	MB166.960/961	82	80.00	222
JR-183-20	170D - 180D 1940/62 - 170DB - 180DB - O319D - L405 - L406 - 170DS/SD F1000 - N1000	<i>Diesel</i>	1696cc.	OM 136	40	73.50	223
			1767cc.	OM 636	45	75.00	
			1767cc.	MB 636-916/18 19/30/31/34	45	75.00	
JD-742-07	CLASE A 190 1999/... - CLASE A 210 - EVOLUTION 2002/... - Vaneo 2001/...		1898cc.	MB166.990	125	84.00	224
			1898cc.	MB166.991	125	84.00	
			2084cc.	MB166.995	140	84.00	
JR-822-11	SPRINTER VITO 2012/... - VIANO 2010/... CDI	<i>Diesel</i>	2143cc.	OM651.940/955	95	83.00	225
SJ-543	SPRINTER 413/411/208/211/213/313 DCI 2000/... - C200 - C220 - E200 - E220 1998/... VITO 108/110/112 CDI INY. DIRECTA 16V (6110104520)	<i>Diesel</i>	2151cc.	OM611 CDI	82/129	88.00	226
			2151cc.	611.980/1	102/125	88.00	
			2151cc.	MB611.960 MB611.961	100/123	88.00	
JR-303-20	240D/TD 1973/... - L406/407DG - 207/307/407/507/510D - 0309D 1977/... 240GD 76/87 - MB100/150/170/200 - MB400/180D	<i>Diesel</i>	2404cc.	MB616.912/934/960	65	91.00	227
			2404cc.	MB616.916/940	72	91.00	
			2404cc.	MB616.961/963	72	91.00	
SJ-272	SPRINTER TDI 1997/... - CHEVROLET: BLAZER TDI - S10 TDI 1995/... FORD: RANGER TDI 1995/... - RANGER TD BR 2000-2002/... ROVER: RANGE ROVER - DISCOVERY - DEFENDER TDI 1990/...	<i>Diesel</i>	2495cc.	200 - 300 TDI	107/112	90.50	231
			2507cc.	Power Stroke	95	90.70	
			2758cc.		135	93.00	

M. FERGUSON						
REF.	MODELO / MODEL		Cm ³	MOTOR / ENGINE	HP	Ø Pist. PAG.
JR-290-20	MF220 - F290 - MF85X - CHEVROLET: GM D10/20/40 ASPIRADO TURBO MAXION-PERKINS: F350 - VW680 - CASE 550 - VEHICULAR (424801/423607)		3860cc.	Q20B4 - 4.236	70	98.40
		<i>Diesel</i>	4070cc.	4.248	70	101.00

M.W.M.						
REF.	MODELO / MODEL		Cm ³	MOTOR / ENGINE	HP	Ø Pist. PAG.
SJ-347	AGRALE: TD (MICRO-ÓMNIBUS) 2000/... - 6000 - FURGON VAN - CHEVROLET: S10 TD - BLAZER TD 2000/... - NISSAN: FRONTIER - X TERRA TD 12V VOLARE: A5 - A6 - A8 - VOLKSWAGEN: LTDI 1997/...		2796cc.	AGK	125	93.00
		<i>Diesel</i>	2796cc.	ATA	131	93.00
			2796cc.	Sprint 4.07 TCA	132	93.00
JR-329-20	AGRALE: TRACTOR 5075.4 - 5085.4/5 - BX6110 - 88 - FIAT: EXCAVADORA FB80 FORD: F100 1993/95 - F1000 1994/96 F4000 1992/93 - F2000 1980/... - FB4000 1985/... - VALMET: 78/88/880/980 4X4 - VOLKSWAGEN: 6.90/7.90/7.110 (922900134317/1997/3237/2338)	<i>Diesel</i>	3922cc.	D229-4	96	102.00
SJ-348	FORD: F100 GMC TURBO 1999/... - CHEVROLET: GM SILVERADO 3500HD/DLX 1997/... - GM GRAND BLAZER 1998/...		4200cc.	Sprint 6.07 TD	167	93.00
		<i>Diesel</i>	4200cc.	Turb. Intercooler	198	93.00

MAXION						
REF.	MODELO / MODEL		Cm ³	MOTOR / ENGINE	HP	Ø Pist. PAG.
SJ-272	CHEVROLET: BLAZER TDI - S10 TDI 1995/... - FORD: RANGER TDI 1995/... RANGER TD BR 2000-02/... M. BENZ: SPRINTER TDI 1997/... ROVER: RANGE ROVER - DISCOVERY DEFENDER TDI 1990/...		2495cc.	200 - 300 TDI	107/112	90.50
		<i>Diesel</i>	2507cc.	Power Stroke	95	90.70
			2758cc.		135	93.00
SJ-524	FORD: RANGER 3.0 16V 4X4 - FULL BR INTERCOOLER 10/2007/...	<i>Diesel</i>	2968cc.	Maxion TD (SOCH) Power stroke	163	96.00
SJ-525	FORD: RANGER 3.0 16V 4X4 - FULL BR INTERCOOLER 2005...10/2007	<i>Diesel</i>	2968cc.	Maxion TD (SOCH) Power stroke	163	96.00
JR-290-20	MAXION-PERKINS: F350 - VW680 - CASE 550 - VEHICULAR CHEVROLET: GM D10/20/40 ASPIRADO TURBO M. FERGUSON: MF220 - F290 - MF85X (424801/423607)		3860cc.	Q20B4 - 4.236	70	98.40
		<i>Diesel</i>	4070cc.	4.248	70	101.00
JR-281-20	S4/S4T/ST4 PLUS - CHEVROLET: GM D20 - D40 - PICK UP D20 - GMC 6150/6100 F1000	<i>Diesel</i>	3990cc.	Maxion S4	102	100.00

MAZDA						
REF.	MODELO / MODEL		Cm ³	MOTOR / ENGINE	HP	Ø Pist. PAG.
JR-513-15	323 - FAMILIA - GLC - LASER TURBO 1980/... (E30199100/E58099100)		1296cc.	E3	60	77.00
			1490cc.	E5-E5T	85	77.00
SJ-274	323 TD - CHEVROLET: CORSA D - COMBO D 1997/... - VECTRA TD 1991/96 ASTRA TD 1994/97 - CAVALIER TD (97721730)		1686cc.	4EE1	60	79.00
		<i>Diesel</i>	1686cc.	4EE1T	82	79.00
			1686cc.	X17 D-T	60/82	79.00
JR-345-20	626TD 1993/97 - 323D 1998/... - KIA: SPORTAGE TD 1996/...		1998cc.	RF	83	86.00
		<i>Diesel</i>	1998cc.	RF - CX	75/82	86.00
JR-362-15	3 2003/... - 5 2005/... - FORD: MONDEO 2001/... - ECOSPORT 2003/... FOCUS 2000/... (T. VÁLVULAS PLÁSTICA)		1999cc.	CJBA/B	143/145	87.50
			1999cc.	AOBA/C	145	87.50
			1999cc.	LF/LH Duratec HE 16V	104	87.50
JR-363-15	3 2003/... - 5 2005/... - FORD: MONDEO 2001/... - ECOSPORT 2003/... FOCUS 2000/... (T. VÁLVULAS DE ALUMINIO)		1999cc.	CJBA/B	143/145	87.50
			1999cc.	AOBA/C	145	87.50
			1999cc.	LF/LH Duratec HE 16V	104	87.50
JR-676-07	B2200D 1987/... E2200D 1991/... (8AZ610271A)	<i>Diesel</i>	2184cc.	R2	64	86.00
JR-675-11	B2500 2002/... MPV TDI 1996/... - Proceed (8ASX10271A)		2500cc.	WL	78	93.00
		<i>Diesel</i>	2500cc.	WLT	84	93.00

MITSUBISHI						
REF.	MODELO / MODEL		Cm ³	MOTOR / ENGINE	HP	Ø Pist. PAG.
JR-670-07	LANCER - COLT - MIRAGE 1983/88 (MD997113)		1468cc.	G15B	70	75.50
			1468cc.	4G15	69	75.50
JR-674-07	GALANT - L200 - L300 - COLT- MIRAGE - LANCER 1981/... (MD997156)		1597cc.	4G32B	65	77.00
JR-745-07	PAJERO IO 1998/... - PAJERO TR4 FLEX 2002/... - MONTERO IO 2001/...		1799cc.	4G93 16V	92	81.00
			1999cc.	4G94 16V	131/136	81.50
SJ-384	SPACESTAR - CARISMA - NISSAN: INTERSTAR - PRIMERA - PRIMASTAR RENAULT: MEGANE DTI/RN/RT - LAGUNA 716/730/734 - CLIO - KANGOO MASTER - SCENIC - SPACE - TRAFIC - VOLVO: S40 - V40 TD	<i>Diesel</i>	1870cc.	F9Q Turbo Inyección Directa	80/100	80.00
JR-669-07	ECLIPSE I 1989/95 - GALANT 1993/95 (MD971619/20)		1997cc.	4G63	116	85.00
			1997cc.	4G63T	182	85.00
JR-673-07	GALANT 1992/96 - LANCER 1992/03 - SPACE WAGON 1992/98 (MD971654/655)		1998cc.	4D68	68	82.70
		<i>Diesel</i>	1998cc.	4D68T	82	82.70
SJ-476	L200 1987/... - CANTER - T35 - PAJERO - MONTERO 1986... CHRYSLER: PICK UP POWER RAM 50 TD 1983/85 - FORD: BRONCO II TD RANGER 2WD 1985/... - HYUNDAI: H100 - H1 D/TD 1986/... - GALLOPER LIBERTO 1998/... (MD972160)		2346cc.	4D55T	67/84	91.00
		<i>Diesel</i>	2476cc.	4D56	70/84	91.00
			2476cc.	D4BA - X/D4BH	75/100	91.10
			2607cc.	D4BB	85	91.10

MITSUBISHI - Continuación...							
REF.	MODELO / MODEL		Cm ³	MOTOR / ENGINE	HP	Ø Pist.	PAG.
JR-728-07	L200 TD 2003/... (1000A407)		<i>Diesel</i> 2470cc.	4D56T	136	91.00	244
SJ-488	L200 1987/... - L300 - CANTER - T35 - PAJERO - MONTERO 1986/... HYUNDAI: H100 - HR 8V 2008/11		<i>Diesel</i> 2476cc.	D4B/H	115/130	91.00	209
			2476cc.	4D56T	115	91.00	
JR-672-07	MONTERO - PAJERO .../2002 - NATIVA TD 1999/... (ME995738/ME994155/ME995497)		<i>Diesel</i> 2835cc.	4M40	94	95.00	245
			2835cc.	4M40T	109	95.00	
JR-764-07	MONTERO - GALANT V6 12V - HYUNDAI: SONATA		2972cc.	6G72 12V	140	91.10	246
JR-744	PAJERO TRITON 2001/... - MONTERO III 2000/...		3200cc.	4M41 TD 16V	165/175	98.50	247

NISSAN							
REF.	MODELO / MODEL		Cm ³	MOTOR / ENGINE	HP	Ø Pist.	PAG.
JR-754-07	MARCH - VERSA 12V		999cc. 1198cc.	HR10DE HR12DE	76 80	78.00 78.00	248
JR-408-07	SUNNY 1200 - 120Y (10101-M3025)		1200cc.	A12 OHC	70	73.00	249
JR-343	PLATINA 16V 2002/... - RENAULT: K4J: CLIO II 2001/... - KANGOO - SCENIC 1999/... - MEGANE II 2003/... - MODUS 2004/... K4M: CLIO - SCENIC - MEGANE SYMBOL - LAGUNA 1998/00 - FLUENCE - DUSTER 838 - LOGAN 2007/... (10101-00QAA)		1390cc.	K4J 16V	95/98	79.50	308
			1598cc.	K4M 16V	110	79.50	
SJ-504	ALMERA - MICRA 2000/... - RENAULT: CLIO II - KANGOO DCI 2001/... MEGANE DCI 2002/... - COMMONRAIL		<i>Diesel</i> 1461cc.	K9K	65/82	76.00	314
JR-489-20	MICRA 1997/... - CITROEN: AX 15 1994/97 - SAXO 1996/... PEUGEOT: 106 1994/... - ROVER: 115TD 1995/98		<i>Diesel</i> 1527cc.	TUD5 (VJY)	55/58	77.00	270
			1527cc.	TUD5 (VJZ)	55/58	77.00	
JR-762-11	MARCH - SENTRA - VERSA - KICKS - LIVINA - RENAULT: CAPTUR - DUSTER DUSTER OROCH - LOGAN II - SANDERO II		1598cc.	HR16DE H4M	108	78.00	250
JR-514	PRIMASTAR 2002/... 16V - RENAULT: LAGUNA 1998/... - SCENIC - MASTER ESPACE - MEGANE - TRAFIC 1999/... - CLIO II - KANGOO CLIO II SPORT 2001/... - DUSTER 2011/...		1783cc.	F4P	115/121	82.70	321
			1998cc.	F4R	140/169	82.70	
JR-729	SENTRA - TIIDA - QASHQAI - X-TRAIL 2007/... - VERSA 2006/... LIVINA / GRAN LIVINA 2008/... - CUBE 2009/... - RENAULT: CLIO III 2006/08 LAGUNA III 2007/... - SCENIC III - MEGANE III 2009/... (10101EN228)		1797cc.	MR18DE 16V	124/126	84.00	251
			1998cc.	MR20DE 16V	140	84.00	
			1997cc.	M4R-700/1/4/11/26	139	84.00	
SJ-384	INTERSTAR - PRIMERA - PRIMASTAR - MITSUBISHI: SPACESTAR - CARISMA RENAULT: MEGANE DTI/RN/RT - LAGUNA 716/730/734 - CLIO - KANGOO MASTER - SCENIC - SPACE - TRAFIC - VOLVO: S40 - V40 TD		<i>Diesel</i> 1870cc.	F9Q Turbo Inyección Directa	80/100	80.00	325
JR-668-20	CABSTAR 1982/... - HOMER - SERENA (1010109W25/T8225/T8227)		<i>Diesel</i> 2289cc.	SD23	68	89.00	252
JR-411-20	PRIMASTER - INTERSTAR 2002/... - RENAULT: MASTER 2001/... - TRAFIC 2003/...		2463cc.	G9U-720/724/730	115	87.00	332
			2463cc.	G9U-750/754	115	87.00	
			2484cc.	G9U-730	90	87.00	
			2499cc.	G9U-720/724/750/754	90	87.00	
JR-730-11	CABSTAR 2006/... - FRONTIER 2009/... - HARDBODY 2006/... - KING CAB TD 2001/... - PATHFINDER 2005/... - NAVARA 2005/... (10101UK525/10101UK527)		<i>Diesel</i> 2488cc.	YD25DDTI 16V	133/172	89.00	253
SJ-527	TERRANO D 1986/... - TERRANO TD 1989/92 - PATHFINDER D - TRUCK D21 FORD: MAVERICK TD 1992/99 (1010143G27)		<i>Diesel</i> 2663cc.	TD27 - TD27T	85/100	96.00	254
SJ-347	NISSAN: FRONTIER - X TERRA TD 12V - AGRALE: TD (MICRO-ÓMNIBUS) 2000/... 6000 - FURGON VAN - CHEVROLET: S10 TD - BLAZER TD 2000/... VOLARE: A5 - A6 - A8 - VOLKSWAGEN: LTDI 1997/...		2796cc.	AGK	125	93.00	228
			2796cc.	ATA	131	93.00	
			2796cc.	Sprint 4.07 TCA	132	93.00	
JR-765-07	PATHFINDER II V6 4WD (101010W025)		<i>Diesel</i> 3275cc.	VG33E/R	180/210	91.50	255

OPEL							
REF.	MODELO / MODEL		Cm ³	MOTOR / ENGINE	HP	Ø Pist.	PAG.
JR-559	Astra H 2004/... - Signum Vectra C 2006/... - Zafira B 2005/... - Insignia 2008/... ALFA ROMEO: 159 2005/... - CHEVROLET: Cruze 1.8 2008/... - Aveo 1.4 2009/... FIAT: Croma 2005/...		1399cc.	F14D4 (DOHC 16V)	101	80.50	52
			1796cc.	F18D4 (DOHC 16V)	141	80.50	
			1796cc.	Z18XER/A18XER	141	80.50	
			1796cc.	939A4 (DOHC 16V)	140	80.50	
JR-188-15	REKORD - CARAVAN 1958/60		1488cc.		44		256
JR-123-15	TIGRA - CHEVROLET: CORSA - ASTRA - ZAFIRA - VECTRA 1993/... - CHEVY		1598cc.	C16XE/XEL 16V	109	79.00	55
			1598cc.	X16XEL 16V	100/109	79.00	
			1598cc.	Y16XE 16V	100/109	79.00	
JR-251-15	OPEL K 180 1974/79 - CHEVROLET: OPALA 1968/73		1790cc.	K180 - 153		90.49	257
JR-481-15	OMEGA A 1986/94 - FRONTERA 1991/95 - CALIBRA - CAVALIER CHEVROLET: MONZA 1986/... - KADETT 1989/... - ASTRA - IPANEMA 1989/... (52278189)		1998cc.	C20NE/SEH/SER OHC	115/130	86.00	68
			1998cc.	C20NEF/SEH OHC	100/130	86.00	
JR-122-15	BRAVA - CAMPO (5878120663) - CHEVROLET: LUV - PICK UP 1986/95 ISUZU: AMIGO - TROOPER II - IMPULSE - ASKA		2254cc.	4ZD1	88/96	89.30	74

PERKINS							
REF.	MODELO / MODEL		Cm ³	MOTOR / ENGINE	HP	Ø Pist.	PAG.
JR-190	DODGE: POLARA - D100 - D200 1987/... - FORD: F100 - PICK UP - FALCON 1970/... JEEP: T1000 1969/80		<i>Diesel</i> 3336cc.	4.203 - P4 - 192Z	71	91.49	258
JR-328	FORD: F100		<i>Diesel</i> 3336cc.	4.203 Potenciado	71	91.44	259

PERKINS - Continuación...							
REF.	MODELO / MODEL		Cm ³	MOTOR / ENGINE	HP	Ø Pist. PAG.	
JR-290-20	MAXION-PERKINS: F350 - VW680 - CASE 550 - VEHICULAR CHEVROLET: GM D10/20/40 ASPIRADO TURBO - M. FERGUSON: MF220 - F290 MF85X (424801/423607)	<i>Diesel</i>	3860cc. 4070cc.	Q20B4 - 4.236 4.248	70 70	98.40 101.00	260
PEUGEOT							
REF.	MODELO / MODEL		Cm ³	MOTOR / ENGINE	HP	Ø Pist. PAG.	
JR-694-15	106 1991/... - 205 1987/93 - 306 - PARTNER 1996/... - CITROEN: SAXO - ZX BERLINGO 1996/... - C15 1988/... - AX 10 1986/...		954cc. 1124cc.	TU9/K/MZ/M TU1M	45/50 54/60	70.00 72.00	261
JR-805-11	107 2005/... - CITROEN: C1 2005/... - DAIHATSU: SIRION - STORIA 2005/... TOYOTA: IQ - AYGO - YARIS 2008/...		998cc.	1KR-FE	65	71.00	93
JR-528	206 16V 2000/... - RENAULT: TWINGO - CLIO - CLIO II 2001/... - KANGOO 16V 2000/... - SANDERO 2009/... - MODUS 2001/... (7701473003)		999cc. 1149cc. 1149cc.	D4D D4D 702/712/720 D4F 700/712/720	68/70 75 75	69.00 69.00 69.00	303
JR-381-15	104 1975/... - 205 1983/87 - CITROEN: VISA II - C15 - VISA SUPER		1124cc. 1219cc.	XW3-XW7 XZ5	55/57 57	72.00 75.00	262
JR-379-15	106 1991/... - 205 1987/96 - 205 RALLYE 1988/93 - 206 1998/... - 306 1993/97 405 1987/96 - PARTNER 1996/... - CITROEN: AX11 - AX SPORT 1987/91 AX GTI 1992/... - BX11 - BX14 - ZX 1991/98 - C15 1986/... - SAXO - XSARA		1124cc. 1294cc. 1360cc.	TU1/TU1M TU2.4 TU3	55/60 102 95/100	72.00 75.00 75.00	263
JR-785-11	208 - CITROEN: C3 III		1199cc.	EB2M (HMY) 12V	72	75.00	264
JR-197-15	403/7 1959/66 - 403/8 1955/67 (0199130)		1290cc. 1468cc.	7CV 8CV	52 55/58	75.00 80.00	265
JR-469-20	106 1994/... - CITROEN: AX 14 1988/94	<i>Diesel</i>	1360cc. 1360cc.	TUD3 TUD3 (K9A)	52 50	75.00 75.00	266
JR-509-15	106 1991/... - 206 1998/... - 207 COMPACT - 306 1993/... - 307 2001/... PARTNER 1996/... - CITROEN: C2 - C3 - C3 PLURIEL 2002/... - BERLINGO 1996/... SAXO ZX 1991/... - FIAT: QUBO - FIORINO QUBO		1360cc.	TU3JP	68/75	75.00	267
SJ-542	107 - 206 - 307 - 1007 - BIPPER HDI 2001/... - CITROEN: C3 - C2 HDI - C1 XSARA HDI 2002/... - FORD: FIESTA - ECOSPORT TD 2003/... - DURATORQ TDCI 1996/98 - FUSION TDCI 2001/...	<i>Diesel</i>	1398cc. 1398cc. 1398cc. 1398cc.	F6JA - F6JB DV4TD(8HX) DV4TD(8HZ) (SOHC) 8V Duratorq	68 54/70 68 68	73.70 73.70 73.70 73.70	146
JR-796-11	208 - CITROEN: C3 III 8V	<i>Diesel</i>	1398cc.	DV4C (8HP/8HR)	68	73.70	268
JR-778	208 ACTIVE/ALLURE 2013/... - CITROEN: C3 PICASSO 2013/...		1450cc.	TU4 8V	90	75.00	269
JR-489-20	106 1994/... - CITROEN: AX 15 1994/97 - SAXO 1996/... NISSAN: MICRA 1997/... - ROVER: 115TD 1995/98	<i>Diesel</i>	1527cc. 1527cc.	TUD5 (VJY) TUD5 (VJZ)	55/58 55/58	77.00 77.00	270
SJ-541	307 HDI 2004/... - 407 TD 2004/... - 206 - 207 COMPACT - 1007 2003/... CITROEN: XSARA - PICASSO - JUMPY - BERLINGO 1999/... - C2 - C3 - C4 C5 TD 16V - FORD: CMAX - FOCUS - FUSION TDCI 16V 2003/... VOLVO: S40 - V50 - C30 2005/...	<i>Diesel</i>	1560cc. 1560cc. 1560cc. 1560cc.	DV6TED4 DV6TD4(9HZ) DV6TED4(9HZ) G8DA - Duratorq (DOHC) 16V	75/109 108 104 90/109	75.00 75.00 75.00 75.00	149
JR-786-11	PEUGEOT: PARTNER - CITROEN: BERLINGO - C4 - C-ELYSEE		1560cc.	DV6DTEd (9HF/HJ/HP)	90	75.00	271
JR-370	305 GTX - 306 - 309 GT 405 1987/93 - CITROEN: BX19 1984/93 - BX16 1985/90 BX16 GTI 1991/93		1580cc. 1905cc. 1905cc. 1905cc.	XU5CP - XU5M XU92C/5 XU9M XU9J1/J2	75/105 96/125 98 102	83.00 83.00 83.00 83.00	272
JR-511	206 - 307 - PARTNER 2000/... - 207 SW - 207 COMPACT - CITROEN: BERLINGO C3 PLURIEL - XSARA 2000/... - C2 - C3 2002/...		1587cc.	TU5JP4 (NFU/N6A) 16V	109	78.50	273
JR-515	106 1994/... - 306 1993/... - 206 1998/... - CITROEN: ZX - SAXO 1996/... XSARA 1997/...		1587cc.	TU5JP/J2	90/103	78.50	274
JR-571	207/CC - 208 2012/... - 308/SW 2007/... - 508/SW/RZ 2010/... - 3008 2009/... CITROEN: C4/PICASSO/GRAND - PICASSO 2008/... - C5/TOURER 2009/... DS3 2010/...		1598cc. 1598cc. 1598cc. 1598cc.	EP6DT (5FX/5FR) EP6DT (5FV/5FT) EP6CDT (5F04) EP6DTS (5FY)	150/156 150/163 156 156	77.00 77.00 77.00 77.00	275
JR-199-15	404 - 504 1962/80 (0199421/0199414)		1618cc.	XC7	59	84.00	276
JR-385	306 1993/... - 405 - 406 1992/... - 806 - EXPERT 1996/... - PARTNER 1996/... CITROEN: XSARA1997/... - XANTIA 1997/01 - EVASION - SYNERGIE - ZX 1992/98 BERLINGO 1997/...		1761cc. 1761cc.	XU7 JP/Z 8V XU7 JB 8V	98/101 90/103	83.00 83.00	277
JR-387	PARTNER 1996/... - CITROEN: BERLINGO 1997/... - XANTIA - XSARA		1761cc.	XU7JB	90	83.00	278
JR-394-15	306 1997/2003 - 406 1995/2000 - CITROEN: XSARA 1997/... - ZX XANTIA 1995/... (B197X170)		1761cc.	XU7 JP4(LFY) 16V	112	83.00	279
JR-594-15	406 1995/00 - CITROEN: XSARA 1997/00		1761cc.	XU7 JP4(LFY) 16V	112	83.00	280
SJ-259	205 - 305 - 306 - 309 - 405 - 406 - 806 TD - EXPERT T/TD - PARTNER BOXER TD 1992/... - CITROEN: XANTIA TD - ZX TD 1993/... - BX 17TD 1988/92 C15 1994/... - BERLINGO 1996/99 - XSARA 1997/... - FIAT: DUCATO TD 1994/... HYUNDAI: LANTRA 1998/... - LADA: NIVA 2121 - ALEKO 1990/... - ROVER: 218 418 T/TD 67HP 1991/96 - SUZUKI: VITARA 68HP 1995/96	<i>Diesel</i>	1769cc. 1769cc. 1905cc. 1905cc.	XUD7 161A/A9A XUD7 T-TE XUD9 XUD9 TE-TF GRD	60 78/90 65/69 90/92	80.00 80.00 83.00 83.00	281

PEUGEOT - Continuación...							
REF.	MODELO / MODEL		Cm ³	MOTOR / ENGINE	HP	Ø Pist.	PAG.
JR-233-15	504 - 505 - J5 - J7 - XE - XL - XSE 1973/93 - CITROEN: C25 1981/... FIAT: DUCATO 1981/... - (0199416)		1796cc.	280/A14-169B	67	84.00	282
			1796cc.	XC7 - XM7/T/P	69/79	85.00	
JR-200-20	404 - T4B - J7 1959/67 - T5B - INDENOR 1971/80 - RASTROJERO: 1972/... (0199541)	<i>Diesel</i>	1816cc. 1948cc.	TMD85/XD85 XD/XDP 4.88	55 50/59	85.00 88.00	283
SJ-257	206 - 306 - 806 - EXPERT - PARTNER 1998/... - CITROEN: BERLINGO - XSARA JUMPY - C15 1998/... - FIAT: SCUDO 1998/... - TOYOTA: COROLLA 1999/2001 (424801/423607/0197X6)	<i>Diesel</i>	1867cc.	DW8 DWJ DWY	69/70	82.20	284
			1868cc.	DW8 (WJZ)	71	82.20	
			1868cc.	1WZ	69	82.20	
SJ-258	206 - 306 - 806 - EXPERT - PARTNER 1998/... - CITROEN: BERLINGO - XSARA JUMPY - C15 1998/... - FIAT: SCUDO 1998/... - TOYOTA: COROLLA 1999/2001 (424801/423607/0197X6) (JVS REFORMA PLANA)	<i>Diesel</i>	1867cc.	DW8 DWJ DWY	69/70	82.20	285
			1868cc.	DW8 (WJZ)	71	82.20	
			1868cc.	1WZ	69	82.20	
JR-276-15	504 - TN - GES - XNA 1976/80 - 505 - J5 - J9 1970/... (0199413)		1971cc.	XN1 - XNA	78/85	88.00	286
JR-317-15	505 GAMMA - 9R - J9/J5 1970/92 - 504 - 505 CON AIRE ACONDICIONADO - 604 (0199424)		1971cc.	GR/SR - XN1/XN2	85	88.00	287
			1971cc.	XN2 - XN6	105	88.00	
JR-512	206 - 307 - 406 - 407 - 607 2001/... - 806 - 807 - EXPERT 2000/... 16V CITROEN: XSARA - EVASION 1998/... C4 2004/... - C5 2001/... - JUMPY DISPACHT - C8 2000/...		1997cc.	EW10J4 RFN	136	85.00	288
			1997cc.	EW10D RLZ	147	85.00	
SJ-397	206/306/406 TD - 307 HDI - BOXER HDI - 406/607/806 HDI - EXPERT PARTNER TD 1999/... - CITROEN: XANTIA - XSARA - BERLINGO - C5 - EVASION SYNERGIE - JUMPY HDI - DISPACHT HDI - XSARA PICASSO HDI - JUMPER HDI SUZUKI: VITARA - GRAND VITARA 2000/...	<i>Diesel</i>	1997cc.	DW10 ATED-RHZ	110	85.00	289
			1997cc.	DW10 TD-RHV	110	85.00	
			1997cc.	DW10 TD-RHY	90	85.00	
JR-592	307 - 407 - 807 2005/... - CITROEN: C4/PALLAS - C4 GRAND PICASSO 2005/... C5 2008/...		1997cc.	EW10JA (RFJ) 16V	136/140/143	85.00	290
SJ-790	EXPERT III - 3008 - CITROEN: JUMPY III - C4 (0197AW)	<i>Diesel</i>	1997cc.	DW10CTED4 (RHC/D/E/H)	150/160	85.00	291
SJ-572	406/607/806/807 HDI 2000/... - EXPERT HDI 1999/... - CITROEN: EVASION 2000/... C5/C8 2001/... - JUMPY 2002/...HDI - FORD: FOCUS - C-MAX TDCI 2003/... LANCIA: PHEDRA JTD - ZETA JTD 2000/...	<i>Diesel</i>	1997cc.	DW10ATED4	109	85.00	292
			1997cc.	DW10JATED4	110	85.00	
			1998cc.	G6DA/G6DC	135	85.00	
			2179cc.	DW12TED4 (DOHC)	130/133	85.00	
JR-386-15	406 - 605 - 806 TURBO 1993/... - CITROEN: XM - XANTIA SINERGIE TURBO 1995/... - EVASION		1998cc.	XU10 J2TE	150	86.00	294
JR-396-15	306 1993/... - 405 1992/... - 806 - BOXER 1994/... - CITROEN: ZX 1992/... XANTIA 1993/98 - JUMPER 1994/... - EVASION		1998cc.	XU10 J2C	123	86.00	293
			1998cc.	XU10 J2U Iny. Multipunto	109	86.00	
JR-505-15	306 1997/... - 405 1995/... - 406 1995/... - 605 1995/... - 806 1998/... CITROEN: XSARA 2000/... - XANTIA 1995/2001 - EVASION 1998/... - SYNERGIE 1998/... (019767/X8)		1998cc.	XU10 J4R 16V	132/135	86.00	295
			1998cc.	XU10 J4R (RFV) 16V	132/135	86.00	
JR-791-11	BOXER III 2006/... - CITROEN: JUMPER III	<i>Diesel</i>	2198cc.	4HU/4HV (P22DTE) Puma	100/120	86.00	296
SJ-560	BOXER HDI 2006/... - CITROEN: JUMPER HDI 2006/... - FIAT: DUCATO 2006/... FORD: RANGER XL 4X2/4X4 TDCI TRANSIT TDCI 2006/...	<i>Diesel</i>	2198cc.	Puma TDCi eTGV	123	86.00	169
			2198cc.	4HU/4HV (P22DTE) (DOHC) 16V	101/120	86.00	
SJ-215	XD2 504/505D - 505/604TD - J7D/J9D - XD3 504/505D - 505/604TD - J9 SSANG YONG: KORANDO FAMILY 1993/96	<i>Diesel</i>	2304cc.	XD2/S/P	70/73	94.00	297
			2498cc.	XD3/P	76/90	94.00	
SJ-598	BOXER MANAGER HDI 2006/... - FIAT: DUCATO JTD MULTIJET 2006/... IVECO: DAILY III/V 2006/... - CITROEN: JUMPER III HDI 2008/...	<i>Diesel</i>	2999cc.	F1CE0481/A/D (30DT) F30DT/FG30DT 16V	136/156 156	95.80 94.40	137

RASTROJERO							
REF.	MODELO / MODEL		Cm ³	MOTOR / ENGINE	HP	Ø Pist.	PAG.
JR-206-15	PICK UP - NP6 1955/66	<i>Diesel</i>	1758cc.	Borgward D4M	42	78.00	298
JR-207-15	PICK UP - KOMBI - FRONTAL - NP66 - P63/P64 - C66 - P67 1964/71 - NC62	<i>Diesel</i>	1797cc.	Borgward D301 - E1D	52	78.00	299
JR-200-20	RASTROJERO 1972/... - PEUGEOT: 404 - T4B - J7 1959/67 - T5B INDENOR 1971/80 (0199541)	<i>Diesel</i>	1816cc.	TMD85/XD85	55	85.00	283
			1948cc.	XD/XDP 4.88	50/59	88.00	

RENAULT							
REF.	MODELO / MODEL		Cm ³	MOTOR / ENGINE	HP	Ø Pist.	PAG.
JR-210-15	GORDINI 1962/64 - DAUPHINE 4L - 4F 1960/64 - FLORIDE - R3 - R5 - R6 - RODEO (9803903)		603/747cc.	680		54.50	300
			782cc.	839		55.80	
			845cc.	670 - 04/05/800		58.00	
JR-376-15	R5 1973/84		845cc.	839.01 - 800.10	39	58.00	301
JR-395-15	TWINGO 1996/... - CLIO 1995/... - KANGOO 1997/... - CLIO II 2000/...		999cc.	D7D	59	69.00	302
			1149cc.	D7F - D7D 734	55/60	69.00	
JR-528	TWINGO - CLIO - CLIO II 2001/... - KANGOO 16V 2000/... - SANDERO 2009/... MODUS 2001/... - PEUGEOT: 206 16V 2000/... (7701473003)		999cc.	D4D	68/70	69.00	303
			1149cc.	D4D 702/712/720	75	69.00	
			1149cc.	D4F 700/712/720	75	69.00	
JR-426-15	728 - 708 - CLIO II 2005/... - TWINGO 2004/...		1149cc.	D4F 728/708 (DOHC) 16V	75	69.00	304

RENAULT - Continuación...							
REF.	MODELO / MODEL		Cm ³	MOTOR / ENGINE	HP	Ø Pist.	PAG.
JR-212-15	CLIO - R19 1990/98 - KANGOO - EXPRESS 1990/95 - MEGANE		1171cc. 1390cc.	E5F/E7F E6J/E7J Energy	55/60 77/80	75.80 75.80	305
JR-371-15	EXPRESS - TWINGO - CLIO 1992/...		1239cc.	C3G	55	74.00	306
JR-213-15	RODEO - R12 - R4L - R4S - R6 - R4 1969/... - R12 TS - R15 1972/75 ESTAFETTE - R10 - R5 1974/84		1289cc. 1289cc.	668.01/10-810.88 810.01/02/03/05/19	54 54/63	73.00 73.00	307
JR-343	K4J: CLIO II 2001/... - KANGOO - SCENIC 1999/... - MEGANE II 2003/... MODUS 2004/... K4M: CLIO - SCENIC - MEGANE - SYMBOL - LAGUNA 1998/00 FLUENCE - DUSTER 838 - LOGAN 2007/... - NISSAN : PLATINA 16V 2002/... (10101-00QAA)		1390cc. 1598cc.	K4J 16V K4M 16V	95/98 110	79.50 79.50	308
JR-344-15	MEGANE - SCENIC RN - KANGOO - CLIO - CLIO II 1995/... - SYMBOL - SANDERO		1390cc. 1598cc.	K7J K7M-744/745	75 75/90	79.50 79.50	309
JR-749	SANDERO 2008/... - LOGAN 2004/...		1390cc. 1598cc.	K7J-710/714 8V K7M-710/718 8V	75 90	79.50 79.50	310
JR-253-15	TRAFIC - R6 GTL - R12 TL/TS 1976/80 - R5 TX 1979/84 - FUEGO - LECAR - BREAK R18 GTL (JUNIOR)		1397cc. 1397cc.	847 847/847.20/81	63/68 48	76.00 76.00	311
JR-298-15	TRAFIC 1982/... - R12 - R11 TL/TS - R18 - JUNIOR 1984/... - DACIA TLX - ENCORE		1397cc.	847	48	76.00	312
JR-299-15	R9 1981/89 - R11 1983/89 - R19 - R21 1988/93 - SUPER CINCO 1982/... ALIANCE - ENCORE		1397cc. 1397cc.	C1J - C2J C1J - C2J Turbo	60/67 104/110	76.00 76.00	313
SJ-504	CLIO II - KANGOO DCI 2001/... - MEGANE DCI 2002/... - COMMONRAIL NISSAN : ALMERA - MICRA 2000/...	<i>Diesel</i>	1461cc.	K9K	65/82	76.00	314
SJ-532	MEGANE II - SANDERO - SYMBOL - SANDERO STEPWAY - LOGAN 2006/...	<i>Diesel</i>	1461cc.	K9K DCI (SOHC) 8V	65/100	76.00	315
JR-650-11	CLIO III/IV - DOKKER - DUSTER - FLUENCE - LATITUDE - LOGAN - SANDERO	<i>Diesel</i>	1461cc. 1461cc. 1461cc. 1461cc.	K9K 608/612/770/820 K9K 884/846 K9K 856/858 K9K 636/782/837	75 90/95 109 110	76.00 76.00 76.00 76.00	316
JR-342-15	TRAFIC - R9 - R11 - R12 - R18 - R19 1988/... - ALLIANCE - ENCORE (7702217513)		1565cc.	C1L - C2L Carburador		77.00	317
JR-372-15	R19 - CLIO - EXPRESS (7702217284)		1565cc.	C3L Inyección	68/72	77.00	318
JR-762-11	CAPTUR - DUSTER - DUSTER OROCH - LOGAN II - SANDERO II NISSAN : MARCH - SENTRA - VERSA - KICKS - LIVINA		1598cc.	HR16DE H4M	108	78.00	250
JR-359-15	R9 - R11 1986/89 - R19 1989/95 - R21 - TRAFIC 1984/90 - CLIO 1984/94 SÚPER CINCO 1986/91 - ALLIANCE - ENCORE - VOLVO : 340 - 360		1721cc. 1721cc. 1721cc.	F2N - F3N F1N B172K	75/94 68/80 80	81.00 81.00 81.00	319
JR-405-15	LAGUNA N7Q/700/704 1994/99 - SAFRANE N7Q/710/711 1996/99 SPACE N7Q 1996/... - VOLVO : S40/V40 B418S 1995/... - B4204S/4204T		1731cc. 1948cc. 1948cc. 1948cc.	B4184S N7Q 16V B4204S/T B4204T	115 138/140 140 160	83.00 83.00 83.00 83.00	320
JR-514	LAGUNA 1998/... - SCENIC - MASTER - ESPACE - MEGANE - TRAFIC 1999/... CLIO II - KANGOO - CLIO II SPORT 2001/... - DUSTER 2011/... NISSAN : PRIMASTAR 2002/... 16V		1783cc. 1998cc.	F4P F4R	115/121 140/169	82.70 82.70	321
JR-368-15	R19 - CLIO - LAGUNA 1991/98 - VOLVO : 440 - 460 - 480 1991/97		1794cc. 1794cc. 1998cc.	F3P Inyección B18U B20F	90 90/113 90/114	82.70 82.70 82.70	322
JR-729	CLIO III 2006/08 - LAGUNA III 2007/... - SCENIC III - MEGANE III 2009/... NISSAN : SENTRA - TIIDA - QASHQAI - X-TRAIL 2007/... - VERSA 2006/... LIVINA / GRAN LIVINA 2008/... - CUBE 2009/... (10101EN228)		1797cc. 1998cc. 1997cc.	MR18DE 16V MR20DE 16V M4R-700/1/4/11/26	124/126 140 139	84.00 84.00 84.00	251
SJ-260	TRAFIC - EXPRESS - R19 - CLIO - KANGOO - SCENIC - MEGANE	<i>Diesel</i>	1870cc.	F8Q	65	80.00	323
SJ-367	R19 - EXPRESS - CLIO II - KANGOO - TRAFIC - SCENIC - MEGANE - RODEO (CÁRTER DE ALUMINIO)	<i>Diesel</i>	1870cc. 1870cc.	F8Q Iny. Directa F8Q Iny. Indirecta	65 65	80.00 80.00	324
SJ-384	MEGANE DTI/RN/RT - LAGUNA 716/730/734 - CLIO - KANGOO - MASTER SCENIC - SPACE - TRAFIC - MIITSUBISHI : SPACESTAR - CARISMA NISSAN : INTERSTAR - PRIMERA - PRIMASTAR - VOLVO : S40 - V40 TD	<i>Diesel</i>	1870cc.	F9Q Turbo Inyección Directa	80/100	80.00	325
JR-825-11	MEGANE II DCI 2006/10 - LAGUNA II DCI 2005/... - ESPACE IV 2006/... GRAND SCENIC III DCI 2009/... - KOLEOS	<i>Diesel</i>	1995cc.	M9R 16V	150/160	84.00	326
JR-286-15	R18 LX/TS/TX/TXE/GTX/GTII - R21 TXE - TRAFIC 1989/... - MASTER 1981/93 ESPACE 1984/97 - FUEGO GTX/GTXII/GTA 1981/86 - JEEP : WRANGLER 83/86 CITROEN : CX - ATHENS		1995cc. 2165cc.	829-J5R/6R/7R 851-J7T	80/102 120	88.00 88.00	327
JR-506-15	MEGANE RT - SCENIC - LAGUNA RT - RXE - ESPACE		1998cc.	F3R 722/796/729	115	82.70	328
JR-824	DUSTER - DUSTER OROCH - CAPTUR - SANDERO 2011/...		1998cc.	F4R-400/2/3/4/5/8 Flex/Hi-Flex 16V	135	82.70	329
SJ-249	R18 1981/86 - R21 1984/97 - FUEGO - ESPACE - TRAFIC 1981/97 MASTER 1980/... R20 - R25 - R30 - CHEVROLET : SPACEVAN - TRAFIC JEEP : JEEP WAGONEER TD 1984/95 - COMANCHE TD 1986/88	<i>Diesel</i>	2068cc. 2068cc.	852/J8S 121	60/86 80	86.00 86.00	330
SJ-783	MASTER III DCI	<i>Diesel</i>	2298cc.	M9T	100/125/150	85.00	331

RENAULT - Continuación...							
REF.	MODELO / MODEL		Cm ³	MOTOR / ENGINE	HP	Ø Pist.	PAG.
SJ-501	MASTER 1990/... - TRAFIC 1990/... SERIE 742/748/770/772/758/780/782 FIAT: NUOVO DUCATO 1989/94 - DUCATO 1994/... IVECO: DAILY 30.8 - 35.8 1996/... (INY. INDIRECTA)	Diesel	2445cc.	8140.67	55	93.00	133
			2499cc.	8140.67X230	85	93.00	
			2499cc.	8140.67F37	82	93.00	
			2499cc.	S8U	57/75/80	93.00	
JR-411-20	MASTER 2001/... - TRAFIC 2003/... - NISSAN: PRIMASTER - INTERSTAR 2002/...	Diesel	2463cc.	G9U-720/724/730	115	87.00	332
			2463cc.	G9U-750/754	115	87.00	
			2484cc.	G9U-730	90	87.00	
			2499cc.	G9U-720/724/750/754	90	87.00	
SJ-450	MASTER TD 1998/... - FIAT: DUCATO 14TDS - DUCATO MAXI 18TDS 1996/... IVECO: TURBO DAILY 3010 - 3510 - 4010 - 4510 - 4910 - 3512 - 4012 - 4512 4912 - 5912 1996/...	Diesel	2799cc.	8140.23	99	94.40	135
			2799cc.	8140.43	122	94.40	
			2799cc.	S9W 700/702	115	94.40	

ROVER							
REF.	MODELO / MODEL		Cm ³	MOTOR / ENGINE	HP	Ø Pist.	PAG.
JR-546-15	114 - 214 - 216 - 218 COUPE 1995/... - 414 1995/99 - 416 1996/99 - 25 45 1999/...		1396cc.	14K16	103	75.00	333
			1589cc.	K16	111	80.00	
			1796cc.	18K16 (DOHC) 16V	120/145	80.00	
JR-489-20	115TD 1995/98 - CITROEN: AX 15 1994/97 - SAXO 1996/... NISSAN: MICRA 1997/... - PEUGEOT: 106 1994/...	Diesel	1527cc.	TUD5 (VJY)	55/58	77.00	270
			1527cc.	TUD5 (VJZ)	55/58	77.00	
SJ-259	218 - 418 T/TD 67HP 1991/96 - CITROEN: XANTIA TD - ZX TD 1993/... - BX 17TD 1988/92 - C15 1994/... - BERLINGO 1996/99 - XSARA 1997/... FIAT: DUCATO TD 1994/... - HYUNDAI: LANTRA 1998/... - LADA: NIVA 2121 ALEKO 1990/... - PEUGEOT: 205 - 305 - 306 - 309 - 405 - 406 - 806 TD - EXPERT T/TD - PARTNER - BOXER TD 1992/... - SUZUKI: VITARA 68HP 1995/96	Diesel	1769cc.	XUD7 161A/A9A	60	80.00	281
			1769cc.	XUD7 T-TE	78/90	80.00	
			1905cc.	XUD9	65/69	83.00	
			1905cc.	XUD9 TE-TF GRD	90/92	83.00	
JR-666-11	420 620 220 1994/00 25 45 2000/05 - HONDA: CIVIC 1997/01 ACCORD 1996/98	Diesel	1994cc.	20T2N	101	84.50	334
			1994cc.	20T2R	86	84.50	
SJ-230	ALFA ROMEO: 75/90TD 1983/... - 155/164TD 1993/... - BORGWARD: VM TURBO CHRYSLER: VOYAGER - GRAND VOYAGER 1992/94 - FORD: SCORPIO TDI GRANADA TDI FALCON 1988/... - ROVER: RANGE ROVER TD 1986/89 TOYOTA: LANDCRUISER 70/250 TD 1987/93	Diesel	1995cc.	VM80A	95	88.00	27
			2393cc.	HR 492	110/113	92.00	
			2499cc.	494 TD / HR425	114/125	92.00	
SJ-272	RANGE ROVER - DISCOVERY - DEFENDER TDI 1990/... - CHEVROLET: BLAZER TDI S10 TDI 1995/... - FORD: RANGER TDI 1995/... - RANGER TD BR 2000-2002/... M. BENZ: SPRINTER TDI 1997/...	Diesel	2495cc.	200 - 300 TDI	107/112	90.50	231
			2507cc.	Power Stroke	95	90.70	
2758cc.				135	93.00		

SEAT							
REF.	MODELO / MODEL		Cm ³	MOTOR / ENGINE	HP	Ø Pist.	PAG.
JR-137-15	133 - 850 - 127 1972/78 - IBIZA 82/88 - ZASTAVA 750 - FIAT: 600 E.R.S. - 750 1961/80 - 800 SPIDER 1962/76 - 770 - 800 - 850 COUPE		767cc.	100D - 170R	32	62.00	98
JR-283-15	133 - 850 - 127 1972/78 - IBIZA 82/88 - FURA - PANDA - MARBELLA - TERRA FIAT: 133 - 600S - BERLINA 1977/82 - UNO 45 - 850 - 850 VAN 1965/76 127 ESPECIAL 1974/...		843cc.	100R	32	62.50	99
			843cc.	100G	37	65.00	
			843cc.	08NCA	35	65.00	
			903cc.	08/09NCA - 146A	40/45	65.00	
JR-361-15	IBIZA - CORDOBA 1996/... - VOLKSWAGEN: GOL 1000 - SAVEIRO - POLO 1995/... PARATI 1997/...		999cc.	AER/ALL/AT (SOHC) 8V	50/69	67.10	362
JR-516	POLO 2003/05 - CADDY 1997/01 - GOL 2001/... - GOL TREND - FOX 2005/... FOX ROUTE - SURAN 2006/... - VOYAGE - DERBY - POINTER - LUPO COMBI BRASIL 2006/14 - VAN - SPORT VAN - SEAT: IBIZA - CORDOBA 2003/...		1391cc.	AUD/AKK/BKR/BLM	75	76.50	369
			1595cc.	BAH/BJA/BPA/BLH	100	76.50	
JR-141-15	1500 1963/71 - FIAT: 1500 BERLINA - MULTICARGA 1963/72 - FAMILIAR 1600 BERLINA - COUPE 1969/72		1481cc.	115 C/BT.038	72	77.00	115
			1600cc.	115 C.2038/20	76	78.00	
JR-475-15	TOLEDO - CORDOBA 2001/05 - IBIZA 2001/03 - LEON 1999/... - AUDI: A3 1996/... SKODA: OCTAVIA 1997/... - VOLKSWAGEN: GOLF 1997/... - POLO 1999/... BORA 1998/... - PASSAT 1996/... - NEW BEETLE		1595cc.	AKL/AHL/ANA/AYD	100	81.00	373
			1595cc.	ARM/AEH/APF/AVU	100	81.00	
JR-510	IBIZA - CORDOBA - TOLEDO 1993/... - VOLKSWAGEN: GOLF - POLO - PASSAT VENTO - GOL/DUBLIN - DERBY - BORA - POINTER		1595cc.	IF AFT/ADZ	70/71	81.00	374
			1781cc.	IF AFT/ADZ	75/90	81.00	
JR-517-15	ALHAMBRA - LEON TURBO 1996/... - AUDI: A3 - A3 QUATTRO 1998/... A6 1997/... - A3 TURBO 1996/... - VOLKSWAGEN: GOLF - SHARAN 1997/... BORA 2000/... - NEW BEETLE - PASSAT TURBO 1999/...		1781cc.	AJP	125	81.00	378
			1781cc.	AGU/AJH/ARZ	150	81.00	
			1781cc.	AJQ/APP	180	81.00	
JR-826-11	LEON TSI 2007/12 - AUDI: A3 - A4 - A5 - Q5 - TT TFSI - VOLKSWAGEN: GOLF VI JETTA - PASSAT FSI/TSI - SCIROCCO - SHARAN TSI - TIGUAN - VENTO TFSI		1798cc.	CDA/A/CDA/B	160/152	82.50	379
			1984cc.	CAEA/CAEB/CAWA/CAWB	170/200	82.50	
			1984cc.	CCTA/CCTB/CCZA/CCZB	170/200	82.50	
			1984cc.	CBFA/CCZC/CDNB/CDNC	170/200	82.50	
SJ-271	IBIZA - TOLEDO - CORDOBA 1991/93 - VOLKSWAGEN: CADDY - TRANSPORTER T.4 1990/92 - POLO - GOLF - PASSAT - VENTO - SYNCRO - CARAVELLE AUDI: 80 D 1989/91 - 80 TD 1991/95	Diesel	1896cc.	1Y - AAZ	64/75	79.50	380
			1896cc.	1X	61	79.50	
JR-338-15	ALHAMBRA - CORDOBA - IBIZA 2000/... - VOLKSWAGEN: TRANSPORTER MINIBUS 2003/... - CADDY 2006/... - GOLF - NEW BEETLE 2002/...		1984cc.	ATM/AZL/AEG	115	82.50	383
			1984cc.	APK/AQY/AZH	109/115	82.50	
JR-769-15	ALHAMBRA - CORDOBA - IBIZA - VOLKSWAGEN: GOLF - NEW BEETLE TRANSPORTER MINIBUS - CADDY		1984cc.	AZG/AEG/AXA/BBX	115	82.50	385
			1984cc.	BEH/VER	116	82.50	
			1984cc.	BSX	109	82.50	

SKODA							
REF.	MODELO / MODEL		Cm ³	MOTOR / ENGINE	HP	Ø Pist. PAG.	
JR-475-15	OCTAVIA 1997/... - AUDI: A3 1996/... - SEAT: TOLEDO - CORDOBA 2001/05 IBIZA 2001/03 - LEON 1999/... - VOLKSWAGEN: GOLF 1997/... - POLO 1999/... BORA 1998/... -PASSAT 1996/... - NEW BEETLE		1595cc.	AKL/AHL/ANA/AYD	100	81.00	373
			1595cc.	ARM/AEH/APF/AVU	100	81.00	
SJ-336	OCTAVIA TDI 1996/... - AUDI: A3 TDI 1996/99 VOLKSWAGEN: BORA - GOLF SDI/TDI 1997/...	<i>Diesel</i>	1896cc.	ALH/AHF/AGR	90/110	79.50	381
			1896cc.	AGP/AHF	68/110	79.50	

SSANG YONG							
REF.	MODELO / MODEL		Cm ³	MOTOR / ENGINE	HP	Ø Pist. PAG.	
SJ-215	KORANDO FAMILY 1993/96 - PEUGEOT: XD2 504/505D - 505/604TD - J7D/J9D XD3 504/505D - 505/604TD - J9	<i>Diesel</i>	2304cc.	XD2/S/P	70/73	94.00	297
			2498cc.	XD3/P	76/90	94.00	

SUZUKI							
REF.	MODELO / MODEL		Cm ³	MOTOR / ENGINE	HP	Ø Pist. PAG.	
JR-491-07	ALTO SS80/F 1980/85 (1140078850/1)		795cc.	F8 - AB51	40	68.50	335
JR-664-07	JIMNY 1977/81 - CARRY 1983/... - CERVO - DAMAS (1140073811/13/18/19/20/21/22)		797cc.	F8A	37	62.00	336
JR-503-07	JIMNY - SUPER CARRY - SAMURAI - JEEP 1000 - SJ410/413 1982/99 (1140080810/4)		970cc.	F10A	45	65.50	337
JR-507-15	SWIFT - CULTUS - VAN TURBO 1984/... - CHEVROLET: SPRINT (1140082810/14)		993cc.	61-G10-G10T	50	74.00	34
JR-521-15	FUN 2002/... - CHEVROLET: CELTA 2000/... - CLASSIC		999cc.	C10NE MPFI 8V (SOCH)	60	71.10	38
JR-663-07	SWIFT JIMNY 1998/... - VITARA WAGON (1140052811/1140076871)		1299cc.	G13BB	76	74.00	338
JR-462-15	SWIFT - SIDEKICK - SAMURAI - JIMNY - CULTUS 1985/89		1324cc.	G13A 8V	60/73	74.00	339
JR-662-07	SWIFT 1989/96 - CULTUS 1990/01 (1140065850/1140071812)		1590cc.	G16B	92	75.00	340
SJ-259	VITARA 68HP 1995/96 - CITROEN: XANTIA TD - ZX TD 1993/... - BX 17TD 1988/92 C15 1994/... - BERLINGO 1996/99 - XSARA 1997/... - FIAT: DUCATO TD 1994/... HYUNDAI: LANTRA 1998/... - LADA: NIVA 2121 - ALEKO 1990/... PEUGEOT: 205 - 305 - 306 - 309 - 405 - 406 - 806 TD - EXPERT T/TD - PARTNER BOXER TD 1992/... - ROVER: 218 - 418 T/TD 67HP 1991/96	<i>Diesel</i>	1769cc.	XUD7 161A/A9A	60	80.00	281
			1769cc.	XUD7 T-TE	78/90	80.00	
			1905cc.	XUD9	65/69	83.00	
			1905cc.	XUD9 TE-TF GRD	90/92	83.00	
JR-772-07	VITARA 1998/06 - SX4 2006/... - GRAND VITARA 1998/06 CHEVROLET: TRACKER 2006/...		1995cc.	J20A 16V (DOHC)	120/129	84.00	67
JR-665-11	GRAND VITARA 2005/... (1140065862)		1995cc.	J20A	128	84.00	341
SJ-397	VITARA - GRAND VITARA 2000/... - CITROEN: XANTIA - XSARA - BERLINGO - C5 EVASION - SYNERGIE - JUMPY HDI - DISPACHT HDI - XSARA PICASSO HDI JUMPER HDI - PEUGEOT: 206/306/406 TD - 307 HDI - BOXER HDI - 406/607/806 HDI - EXPERT - PARTNER TD 1999/...	<i>Diesel</i>	1997cc.	DW10 ATED-RHZ	110	85.00	289
			1997cc.	DW10 TD-RHV	110	85.00	
			1997cc.	DW10 TD-RHY	90	85.00	

TORINO							
REF.	MODELO / MODEL		Cm ³	MOTOR / ENGINE	HP	Ø Pist. PAG.	
JR-218-15	IKA: UTILITARIO - GLADIATOR - TORINO 1965/74 - JEEP T80 1966/73 - RAMBLER MOTOR TORNADO		2966cc.	OHC 181 - 300/S 380/W 4 Bancadas	140/160	84.94	342
JR-228-15	IKA: TORINO TORNADO REFORMA 1973/74		3770cc.	OHC 230 4 Bancadas	180	84.94	343
JR-257-15	TORINO GRAN ROUTIER TS 626 1975/81		3770cc.	OHC 181 - 230 - 300 380 7 Bancadas		84.94	344

TOYOTA							
REF.	MODELO / MODEL		Cm ³	MOTOR / ENGINE	HP	Ø Pist. PAG.	
JR-805-11	IQ - AYGO - YARIS 2008/... - CITROEN: C1 2005/... - DAIHATSU: SIRION STORIA 2005/... - PEUGEOT: 107 2005/...		998cc.	1KR-FE	65	71.00	93
JR-459-15	COROLLA 1999/... - COROLLA FIELDER 03/... - AVENSIS 2000/... COROLLA VVTI 2008/... - FIELDER VVTI 2008/... - RAV4 2000/... CELICA GT 2000/05 - MATRIZ 2003/08 - MR2 SPYDER 2000/05		1398cc.	4ZZFE/VVT	97	79.00	345
			1598cc.	1ZZFE	110	79.00	
			1794cc.	3ZZFE	129/136	79.00	
JR-563	ETIOS 2012/... - ETIOS CROSS 2012/...		1496cc.	2NR-FE 16V	90	72.50	346
JR-504-07	HILUX - CROWN - TOWNACE - LITEACE - CORONA - DYNA 100/150 - HIACE MASTERACE - DELTA WIDE - ROCKY 1982/.. (0411172010)		1626cc.	1Y-J	79/90	86.00	347
			1812cc.	2Y	79/90	86.00	
			1998cc.	3Y	79/90	86.00	
SJ-257	COROLLA 1999/2001 - CITROEN: BERLINGO - XSARA - JUMPY - C15 1998/... FIAT: SCUDO 1998/... - PEUGEOT: 206 - 306 - 806 - EXPERT - PARTNER 1998/... (424801/423607/0197X6)	<i>Diesel</i>	1867cc.	DW8 DWJ DWY	69/70	82.20	284
			1868cc.	DW8 (WJZ)	71	82.20	
			1868cc.	1WZ	69	82.20	
SJ-258	COROLLA 1999/2001 - CITROEN: BERLINGO - XSARA - JUMPY - C15 1998/... FIAT: SCUDO 1998/... - PEUGEOT: 206 - 306 - 806 - EXPERT - PARTNER 1998/... (424801/423607/0197X6) (JVS REFORMA PLANA)	<i>Diesel</i>	1867cc.	DW8 DWJ DWY	69/70	82.20	285
			1868cc.	DW8 (WJZ)	71	82.20	
			1868cc.	1WZ	69	82.20	
JR-660-11	CORONA - AVENSIS TD 1997/00 - COROLLA 1996/01 (0411164180)	<i>Diesel</i>	1975cc.	2C-T	83	86.00	348
			1975cc.	2C-TE	90	86.00	
			2184cc.	3C-TE	90	86.00	

TOYOTA - Continuación...						
REF.	MODELO / MODEL		Cm ³	MOTOR / ENGINE	HP	Ø Pist. PAG.
SJ-230	LANDCRUISER 70/250 TD 1987/93 - ALFA ROMEO: 75/90TD 1983/... - 155/164TD 1993/... - BORGWARD: VM TURBO - CHRYSLER: VOYAGER - GRAND VOYAGER 1992/94 - FORD: SCORPIO TDI - GRANADA TDI FALCON 1988/... ROVER: RANGE ROVER TD 1986/89	<i>Diesel</i>	1995cc.	VM80A	95	88.00
			2393cc.	HR 492	110/113	92.00
			2499cc.	494 TD / HR425	114/125	92.00
JR-722-07	DYNA 200 1995/... - HILUX 1989/93 - LITEACE - STOUT - TOWNACE VAN VAN WAGON 1986/90 - DAIHATSU: ROCKY 1993/01 (0411173040/73046/72010)	<i>Diesel</i>	2237cc. 2237cc.	4Y 4Y-EC	93/94 94/98/101	91.00 91.00
JR-659-11	HILUX HI-ACE DYNA 100 1988/90 - CORONA 1989/96 MARK-II 1989/... (0411154080)	<i>Diesel</i>	2446cc.	2L	75/83	92.00
SJ-341	HILUX D-4D 2001/... - HILUX D-4WD 2005/... - SW4 D-4WD 2004/... DYNA 150 2001/... - FORTUNER 2005/... - INNVOVA 2001/... - LANDCRUISER 90 2000/... - LANDCRUISER 120 2002/... - LANDCRUISER PRADO 120 2006/09	<i>Diesel</i>	2494cc.	2KD-FTV	88/102	92.00
			2982cc.	1KD-FTV DOHC 16V	109/170	96.00
JR-454-07	CELICA 1978/82 - CORONA 1978/83 - CARINA 1978/82 - CRESSIDA 1978/83 (0411137031)		1972cc.	21R	105	84.00
			1972cc.	21R-U	105	84.00
JR-542-07	HILUX - HIACE - TOYO ACE - DYNA 150 1990/... - LANDCRUISER 1988/... (0411154094)	<i>Diesel</i>	2779cc.	3L/3LT	84/123	96.00
JR-658-07	DYNA 1980/95 - LANDCRUISER 1980/... - DELTA - COSTER 1980/83 TOYOACE 1980/88 (0411156030/40)	<i>Diesel</i>	2779cc.	B	80	95.00
SJ-544	HILUX - HIACE - 4 RUNNER - LANDCRUISER TD 1993/2000 (0411167020/23/30)	<i>Diesel</i>	2982cc.	1KZ-T/TE (SOHE)	123/125	96.00
JR-543-07	HILUX LN 147/152/167/172 1997/... - HIACE LH 162/172/174/1824 LANDCRUISER PRADO - DYNA 150 1998/... (0411154220)	<i>Diesel</i>	2987cc.	5L/5L-E	90/97	99.50
JR-768-07	PRADO - 4 RUNNER		3378cc.	5VZ-FE	190	93.50
JR-657-07	DYNA - COASTER - LANDCRUISER 1980/88 (0411158010/40/50)	<i>Diesel</i>	3432cc.	3B	90	102.00
JR-766-07	LAND CRUISER 1975/84	<i>Diesel</i>	4230cc.	2F	135	94.00
JR-767-07	LANDCRUISER - 4 RUNNER		4464cc.	2UZ-FE	270	94.00

VALIANT						
REF.	MODELO / MODEL		Cm ³	MOTOR / ENGINE	HP	Ø Pist. PAG.
JR-221-15	DODGE: VALIANT I/II/III/IV - D100 - D2800 - POLARA - GT CORONADO RT 1964/79 GTX PICK UP 1962/80 (2488777)		2788cc.	170	130	86.36
			3687cc.	225	130	86.36

VALTRA VALMET						
REF.	MODELO / MODEL		Cm ³	MOTOR / ENGINE	HP	Ø Pist. PAG.
JR-329-20	78/88/880/980 4X4 - AGRALE: TRACTOR 5075.4 - 5085.4/5 - BX6110 - 88 FIAT: EXCAVADORA FB80 - FORD: F100 1993/95 - F1000 1994/96 - F4000 1992/93 F2000 1980/... - FB4000 1985/... - VOLKSWAGEN: 6.90/7.90/7.110 (922900134317/1997/3237/2338)	<i>Diesel</i>	3922cc.	D229-4	96	102.00

VOLARE						
REF.	MODELO / MODEL		Cm ³	MOTOR / ENGINE	HP	Ø Pist. PAG.
SJ-347	VOLARE: A5 - A6 - A8 - AGRALE: TD (MICRO-ÓMNIBUS) 2000/... - 6000 - FURGON VAN - CHEVROLET: S10 TD - BLAZER TD 2000/... - NISSAN: FRONTIER - X TERRA TD 12V - VOLKSWAGEN: LTDI 1997/...	<i>Diesel</i>	2796cc.	AGK	125	93.00
			2796cc.	ATA	131	93.00
			2796cc.	Sprint 4.07 TCA	132	93.00

VOLKSWAGEN						
REF.	MODELO / MODEL		Cm ³	MOTOR / ENGINE	HP	Ø Pist. PAG.
JR-490-15	GOL 1993/... - FORD: ESCORT 1.3 1983/... - ESCORT HOBBY 1.0 1993/...		997cc.	CHT/AE		70.30
			1300cc.	CHT/AE		71.50
JR-361-15	GOL 1000 - SAVEIRO - POLO 1995/... - PARATI 1997/... SEAT: IBIZA - CORDOBA 1996/...		999cc.	AER/ALL/AT (SOHC) 8V	50/69	67.10
JR-536	GOL 1000 - SAVEIRO 1998/... - PARATI 16V		999cc.	AT-ASW-AZP (DOHC) 16V	69/76	67.10
JR-547	GOL POWER 2002/... BRASIL		999cc.	AT (DOHC)16V	76	67.10
JR-548	GOL POWER 2002/... BRASIL		999cc.	AT (SOHC)8V	50/59	67.10
JR-549	FOX 2003/... BRASIL		999cc.	AQZ - BJE 8V	71/72	67.10
JR-761	UP! 2013/...		999cc.	CHYA	60	74.50
			999cc.	CHYB	75	74.50
JR-285-07	PICK UP KOMBI BUS - TRANSPORTER - BEETLE 1965/... - ESCARABAJO - FUSCA SEDAN - VARIANT - BRASILIA - KHARMANN (1111980072)		1285cc.	E-F-AB-AC-AR	46	77.00
			1493cc.	H-K-L-M-N	52	83.00
			1584cc.	T-AF-AD Refrigerado a aire	65	83.50
JR-516	POLO 2003/05 - CADDY 1997/01 - GOL 2001/... - GOL TREND - FOX 2005/... FOX ROUTE - SURAN 2006/... - VOYAGE - DERBY - POINTER - LUPO COMBI BRASIL 2006/14 - VAN - SPORT VAN - SEAT: IBIZA - CORDOBA 2003/...		1391cc.	AUD/AKK/BKR/BLM	75	76.50
			1595cc.	BAH/BJA/BPA/BLH	100	76.50
JR-453-15	PASSAT - GOLF - DASHER (USA) - SCIROCCO - RABBIT - BRASIL 1974/82		1457cc.	ZC/YJ/FL/FB	65/85	76.50
			1457cc.	FD/FH/FK	65/85	76.50
JR-130-15	1500 - 1800 1982/... - DODGE: D1500 1971/81 - D1800 1975/81 - PAIKAN GT90 - GT100 1971/...		1498cc.	Hillman	72	86.00
			1798cc.	Hillman	110	86.00

VOLKSWAGEN - Continuación...							
REF.	MODELO / MODEL		Cm ³	MOTOR / ENGINE	HP	Ø Pist.	PAG.
JR-339-15	SAVEIRO - GOL - VOYAGE - LOGUS 1989/... - FORD: ESCORT L/GL/GHIA CORCEL II - SCALA - PAMPA 1983/... - DEL REY - VERONA 1989/... - BELINA II		1555cc.	CHT	73	77.00	148
			1555cc.	AE	73	77.00	
JR-302-15	CADDY - VAN - PASSAT - JETTA - SANTANA - GOL - GOLF - GACEL 1975/84 COUPE 1980/81 - POINTER - LUPO - FOX 1979/83 - AUDI: 4000 - 80 - 4E - 100		1588cc.	YN/YP/YH/YT/YS	110	79.50	371
			1588cc.	VY/VZ/YW/YN	75/85	79.50	
			1588cc.	EM/FS/FT/FR/FN	75/110	79.50	
			1588cc.	FP/WP/WY/WV	75/110	79.50	
SJ-242	SENDA - SAVEIRO - GOL - CADDY - GOLF - PASSAT - KOMBI - SANTANA 1981/86 JETTA - AUDI: 80 D/TD 1981/85	<i>Diesel</i>	1588cc.	CR/JK/DR/JF/C5	54/70	76.50	372
JR-475-15	GOLF 1997/... - POLO 1999/... - BORA 1998/... -PASSAT 1996/... - NEW BEETLE AUDI: A3 1996/... - SEAT: TOLEDO - CORDOBA 2001/05 - IBIZA 2001/03 LEON 1999/... - SKODA: OCTAVIA 1997/...		1595cc.	AKL/AHL/ANA/AYD	100	81.00	373
			1595cc.	ARM/AEH/APF/AVU	100	81.00	
JR-510	GOLF - POLO - PASSAT - VENTO - GOL/DUBLIN - DERBY - BORA - POINTER SEAT: IBIZA - CORDOBA -TOLEDO 1993/...		1595cc.	IF AFT/ADZ	70/71	81.00	374
			1781cc.	IF AFT/ADZ	75/90	81.00	
JR-326-15	GACEL - SENDA - VOYAGE - SANTANA - CARAT - GOL - GOLF - PASSAT - POLO CLASSIC - FOX - POINTER - LUPO - DERBY - FORD: ESCORT - ORION - SCALA PAMPA - BELINA		1595cc.	AP	70	81.00	375
			1781cc.	AP	85/87	81.00	
JR-718-15	SURAN - SURAN CROSS - SAVEIRO - SAVEIRO CROSS 2015/... - NOVO FOX GOL RALLYE - POLO 2017/... - VIRTUS 2018/... - VOYAGE		1598cc.	CWVA (EA211 MSI)	110	76.50	376
			1598cc.	CWVB (EA211 MSI)	90	76.50	
JR-414-15	PASSAT 1996/... - PASSAT TURBO 1996/98 - AUDI: A4 - A4 TURBO 94/... A6 - A6 TURBO 95/... - CABRIO 1997/... - A6 QUATTRO 1999/...		1781cc.	AFY/ADR	115/125	81.00	377
			1781cc.	AEB/AJL/ANB	150/180	81.00	
JR-517-15	GOLF - SHARAN 1997/... - BORA 2000/... - NEW BEETLE - PASSAT TURBO 1999/... - AUDI: A3 - A3 QUATTRO 1998/... - A6 1997/... - A3 TURBO 1996/... SEAT: ALHAMBRA - LEON TURBO 1996/...		1781cc.	AJP	125	81.00	378
			1781cc.	AGU/AJH/ARZ	150	81.00	
			1781cc.	AJQ/APP	180	81.00	
JR-826-11	GOLF VI - JETTA - PASSAT FSI/TSI - SCIROCCO - SHARAN TSI - TIGUAN VENTO TFSI - AUDI: A3 - A4 - A5 - Q5 - TT TFSI - SEAT: LEON TSI 2007/12		1798cc.	CDA/CDAB	160/152	82.50	379
			1984cc.	CAEA/CAEB/CAWA/CAWB	170/200	82.50	
			1984cc.	CCTA/CCTB/CCZA/CCZB	170/200	82.50	
			1984cc.	CBFA/CCZC/CDNB/CDNC	170/200	82.50	
SJ-271	CADDY - TRANSPORTER T.4 1990/92 - POLO - GOLF - PASSAT - VENTO - SYNCRO CARAVELLE - AUDI: 80 D 1989/91 - 80 TD 1991/95 - SEAT: IBIZA - TOLEDO CORDOBA 1991/93	<i>Diesel</i>	1896cc.	1Y - AAZ	64/75	79.50	380
			1896cc.	1X	61	79.50	
SJ-336	BORA - GOLF SDI/TDI 1997/... - AUDI: A3 TDI 1996/99 SKODA: OCTAVIA TDI 1996/...	<i>Diesel</i>	1896cc.	ALH/AHF/AGR	90/110	79.50	381
			1896cc.	AGP/AHF	68/110	79.50	
SJ-596	AMAROK TDI 16V 2010/... - CRAFTER 30/35/50 16V 2011/...	<i>Diesel</i>	1968cc.	CDBA	122	81.00	382
			1968cc.	CDCA	163	81.00	
JR-338-15	TRANSPORTER MINIBUS 2003/... - CADDY 2006/... - GOLF - NEW BEETLE 2002/... SEAT: ALHAMBRA - CORDOBA - IBIZA 2000/...		1984cc.	ATM/AZL/AEG	115	82.50	383
			1984cc.	APK/AQY/AZH	109/115	82.50	
JR-360-15	CARAT - QUANTUM - POINTER - GOL - GOLF - SANTANA 1989/... FORD: GALAXY VERSAILLES - VERONA - ESCORT 92/96		1984cc.	Audi 827 AP	107/115	82.50	159
JR-461-15	GOLF 1992/06 - JETTA - PASSAT - VENTO - GOLF CABRIOLET 1999/02 POLO 1999/... (DESDE MOTOR 031252)		1984cc.	ABA/AKR/ATU	115	82.50	384
			1984cc.	AWF/AWG/AGG	115	82.50	
JR-769-15	GOLF - NEW BEETLE - TRANSPORTER MINIBUS - CADDY SEAT: ALHAMBRA - CORDOBA - IBIZA		1984cc.	AZG/AEG/AXA/BBX	115	82.50	385
			1984cc.	BEH/VER	116	82.50	
			1984cc.	BSX	109	82.50	
JR-751-15	GOL 1995/2000 - GOLF 1992/97 - PASSAT 1994/96 - PARATI 1996/2000		1985cc.	ABF 16V	150	82.50	386
JR-752-07	JETTA 2005/07 - BORA 2005/07 - GOLF 2007/... - NEW BEETLE 2005/07 VENTO 2005/...		2480cc.	CBTA/CBUA/CCCA 20V	170	82.50	387
			2480cc.	BTK 20V	150	82.50	
			2480cc.	BPR/BPS 20V	150	82.50	
			2480cc.	BGP/DBQ 20V	150	82.50	
SJ-347	VOLKSWAGEN: LTDI 1997/... - AGRALE: TD (MICRO-ÔMNIBUS) 2000/... - 6000 FURGON VAN - CHEVROLET: S10 TD - BLAZER TD 2000/... - NISSAN: FRONTIER X-TERRA TD 12V - VOLARE: A5 - A6 - A8	<i>Diesel</i>	2796cc.	AGK	125	93.00	228
			2796cc.	ATA	131	93.00	
			2796cc.	Sprint 4.07 TCA	132	93.00	
JR-329-20	6.90/7.90/7.110 - TRACTOR 5075.4 - 5085.4/5 - BX6110 - 88 - FIAT: EXCAVADORA FB80 - FORD: F100 1993/95 - F1000 1994/96 F4000 1992/93 - F2000 1980/... FB4000 1985/... - VALMET: 78/88/880/980 4X4(922900134317/1997/3237/2338)	<i>Diesel</i>	3922cc.	D229-4	96	102.00	229

VOLVO							
REF.	MODELO / MODEL		Cm ³	MOTOR / ENGINE	HP	Ø Pist.	PAG.
SJ-541	S40 - V50 - C30 2005/... - CITROEN: XSARA - PICASSO - JUMPY BERLINGO 1999/... - C2 - C3 - C4 - C5 TD 16V - FORD: CMAX - FOCUS - FUSION TDCI 16V 2003/... - PEUGEOT: 307 HDI 2004/... - 407 TD 2004/... - 206 - 207 COMPACT - 1007 2003/...	<i>Diesel</i>	1560cc.	DV6TED4	75/109	75.00	149
			1560cc.	DV6TD4(9HZ)	108	75.00	
			1560cc.	DV6TED4(9HZ)	104	75.00	
			1560cc.	G8DA - Duratorq (DOHC) 16V	90/109	75.00	
JR-557	C30 S40 V50 2005/... - FORD: FOCUS 2004/... - FIESTA FUSION 2003/... CMAX 2007/...		1596cc.	L4 Sigma (16V DOHC)	100	79.00	150
			1596cc.	FYJA/B/C (16V DOHC)	100	79.00	
			1596cc.	HWDA/B (16V DOHC)	100	79.00	
			1596cc.	SHDA/B/C B4164S3	101	79.00	

Juego Completo de Reparación:

Jogo de Juntas do Motor / Full Set Gasket:

JR-347-15**Semi-Juego de Reparación:**

Semi-Jogo de Juntas / Semi-Set Gasket:

SJ-346**Juego de Descarbonización:**

Jogo de Juntas Superior / Head Set Gasket:

JD-346-15

JUNTA CULATA DE CILINDROS	TC-470-15	∅ 77.00mm	1.80mm	↑ ↓ ↑ ↓ ↑ ↓ ↑ ↓ ↑ ↓
Junta de cabeçote				
Cylinder Head gasket				

DESCRIPCIÓN / Descrição / Description

ASIA: Towner 1993/2002

MOTOR / Engine

CM³

HP

∅ PISTON

CD

843

40/45

70.00

ILLINOIS

ASIA

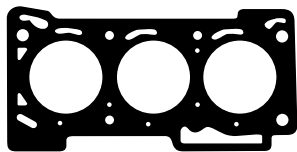
JD-346-15

TC-470-15 - AA1001027
Junta Culata de Cilindros
Junta Cabeçote



1146800
Termostato



1151600 - AA10015165
Acople bomba de agua
Acoplamento bomba de água



JAE-300-E - AA10013462
Junta Escape
Junta Escapamento



JAE-302-A - AA10013111
Junta Admisión
Junta Admissão



JSA-312
Salida Escape
Saída Escapamento

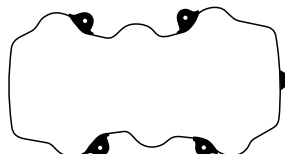

JVS-308-43 - AA10010225
Junta Tapa Válvula Superior
Junta Tampa Válvula Superior



1146200 - AA10015162
Placa bomba de agua
Placa bomba de água



1147100 - AA16014342
Base bomba de aceite
Base bomba de óleo

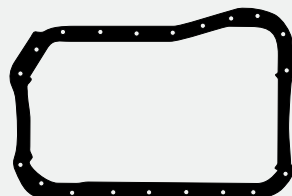

JC-309-43 - AA10010431
Junta Cáster
Junta Carter



1144700 - AA10015116
Tapa bomba de agua
Tampa bomba de água



1144000 - AA10010502
Tapa distribución
Tampa distribuição



1148200
Tapa trasera
Tampa traseira



1148500 - AA10013449
Base bomba de nafta
Base bomba gasolina



1147300 - AA10010662
Tapa bancada trasera
Tampa mancal traseiro

Productos relacionados no incluidos en el juego. Los mismos pueden ser solicitados por separado.

Produtos relacionados não incluídos no jogo. Podem ser solicitados em separado.

Related products that were not included in the set but can be ordered separately.

DESCRIPCIÓN / Descrição / Description **DIESEL**

ASIA: Topic - Hi Topic 1993/... (K61210271)

MOTOR / Engine	CM ³	HP	Ø PISTON
SS	2701	69/75	96.00

Juego Completo de Reparación:

Jogo de Juntas do Motor / Full Set Gasket:

JR-348-20

R

Semi-Juego de Reparación:

Semi-Jogo de Juntas / Semi-Set Gasket:

SJ-349

R

Juego de Descarbonización:

Jogo de Juntas Superior / Head Set Gasket:

JD-349-20

R

JUNTA CULATA DE CILINDROS	TC-756-20	Ø 97.50mm	1.60mm	↕	↕	↕	↕
Junta de cabeçote				↕	↕	↕	↕
Cylinder Head gasket				↕	↕	↕	↕



JD-349-20

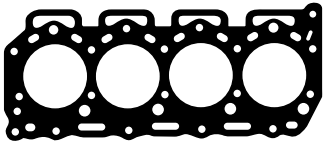

TC-756-20 - 0145610233
Junta Culata de Cilindros
Junta Cabeçote



1000900 - 0063610181A
Tapa trasera tapa cilindros
Tampa traseira cabeçote



1000700 - 0136315173
Termostato



JAE-326-E - 0075013461A
Juego Escape
Jogo Escapamento



JAE-333-A - 006313111
Juego Admisión
Jogo Admissão



JSA-311 - 0063613438
Salida Escape
Saída Escapamento

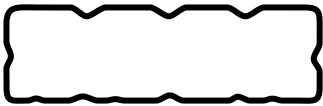

JVS-310-43 - 0136310431
Junta Tapa Válvula Superior
Junta Tampa Válvula Superior

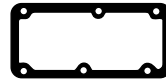

1000600 - 0063610181A
Caja termostato
Caixa termostato



1000800 - 0130415621
Calefactor
Aquecedor



JC-316-30 - 0136310432
Junta Carter
Junta Carter



1000500 - 0258214342
Base filtro aceite
Base filtro óleo



1001500
Unión distribución
União distribuição



1000200 - 0063615116
Tapa bomba de agua
Tampa bomba de água

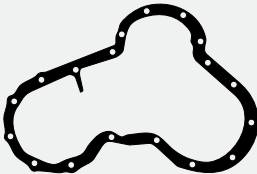

1000000 - KX0910611
Tapa distribución
Tampa distribuição



1001000 - 0063613812
Bomba inyectora
Bomba injetora



1001100 - 0063615081
Soporte bomba de agua
Suporte bomba água



1001700
Porta retén bancada
Flange traseiro do virabrequim



1000100 - 0063610511
Placa distribución
Placa distribuição



1001400
Llenado aceite
Enchimento óleo



1001600 - 0063610711
Junta soporte bomba de agua
Junta suporte bomba de água



1001300 - 0063614285
Acople caño aceite
Acoplamento cano óleo



1000400
Base bomba combustible
Base bomba combustível



1001200 - 0063614248
Filtro bomba
Filtro bomba



RT-8835Pol
Retén Bancada
Retentor Traseiro do Virabrequim
Lx-H 101,57 x 125,00 x 13,00



RT-8577Pol
Retén Distribución
Retentor Dianteiro do Virabrequim
Lx-H 51,00 x 70,00 x 11,00

R

Productos relacionados no incluidos en el juego. Los mismos pueden ser solicitados por separado.

Produtos relacionados não incluídos no jogo. Podem ser solicitados em separado.

Related products that were not included in the set but can be ordered separately.

Juego Completo de Reparación:

Jogo de Juntas do Motor / Full Set Gasket:

Semi-Juego de Reparación:

Semi-Jogo de Juntas / Semi-Set Gasket:

SJ-230**R****Juego de Descarbonización:**

Jogo de Juntas Superior / Head Set Gasket:

JUNTA CULATA DE CILINDROS	TC-503-20 0M	∅ 98.50mm	± 1.45mm	± de 0,36 a 0,44mm
	TC-503-20 2M	∅ 98.50mm	± 1.60mm	± de 0,45 a 0,53mm
Junta de cabeçote	TC-503-20 1M	∅ 98.50mm	± 1.85mm	± de 0,54 a 0,62mm
Cylinder Head gasket		∅	±	±

DESCRIPCIÓN / Descrição / Description

DIESEL**BORGWARD:** VM Turbo - **ROVER:** Range Rover TD 1986/89**ALFA ROMEO:** 75/90TD 1983/... - 155/164TD 1993/...**CHRYSLER:** Voyager- Grand Voyager 1992/94**FORD:** Scorpio TDI - Granada TDI - Falcon 1988/...**TOYOTA:** Landcruiser 70/250 TD 1987/93

MOTOR / Engine	CM ³	HP	∅ PISTON
VM80A	1995	95	88.00
HR 492	2393	110/113	92.00
494 TD / HR425	2499	114/125	92.00

ILLINOIS

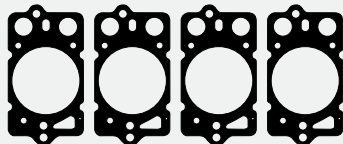
BORGWARD

TC-503-20 0M - 22030460B
TC-503-20 2M - 22030461B
TC-503-20 1M
 Junta Culata de Cilindros
 Junta Cabeçote



JSA-183 - 22022025A
 Salida Escape
 Saída Escapamento



JSA-186 - 22030448A
 Salida Escape
 Saída Escapamento



1112700 - 22030389
 Bomba inyectora
 Bomba injetora



JAE-338-A - 22030350A
 Juego Admisión
 Jogo Admissão



JAE-331-09 - 22030403A
 Juego Escape
 Jogo Escapamento



JT-108-02
 813/913/814/914
 Base Turbo



JVS-234-26 - 22031007A
 Juntas Tapa Válvula Superior
 Juntas Tampa Válvula Superior



1112300 - 22030356A
 Entrada aceite turbo
 Entrada óleo turbo



1112400 - 22030357A
 Salida aceite turbo
 Saída óleo turbo



1112100 - 22030162A
 Cuenta vueltas
 Conta voltas



1112200 - 22030338A
 Tapa cilindro a tubo respiración
 Tampa Cabeçote ao tubo respiração



JC-282-26 - 22030365A
 Junta Cártel
 Junta Carter



1112800 - 22030408A
 Tubo colector termostato
 Tubo coletor termostato

2735200 - Juego Arandelas de Goma/Jogo Arruelas de Borracha

Gráfico	Descripción/Descrição	Cant./Quant
	O'ring Camisa de TC 94,6x2,62mm Silic.	12
	O'ring 158,4x2,62mm	1
	O'ring 63,4x2,62mm	4
	O'ring 37,69x3,53mm	1
	O'ring 37,5x2,45mm	3
	O'ring 32,99x2,63mm	1
	O'ring 32,5x2,40mm Silicona	1
	O'ring 26,6x3,53mm Silicona	1
	O'ring 19,5x1,78mm Silicona	4

2627500 - Juego Arandelas Metálicas/Jogo Arruelas Metálicas

Gráfico	Descripción/Descrição	Cant./Quant.
	Aran./Arruela 30x36x2mm Aluminio	1
	Aran./Arruela 22x27x1mm Aluminio	4
	Aran./Arruela 20x26x1mm Aluminio	7
	Aran./Arruela 18x24x1,5mm Alum.	11
	Aran./Arruela 15x21x2mm Cobre	4
	Aran./Arruela 14x18x1,5mm Alum.	27
	Aran./Arruela 12x16x1mm Aluminio	4
	Aran./Arruela 10x14x1,0mm Alum.	10
	Aran./Arruela 8x12x1mm Aluminio	24
	Aran./Arruela 6x10x1mm Aluminio	8

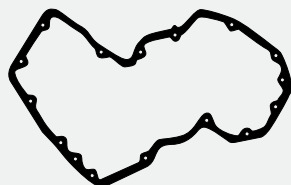

1112500 - 22030363A
 Distribución
 Distribuição



1112600 - 22030371A
 Bomba de agua
 Bomba de água



RT-8274Pol
 Retén Distribución
 Retentor Dianteiro do Virabrequim
 Lx-Hel 56,00 x 80,00 x 10,00



RT-8124Pol
 Retén Bancada
 Retentor Traseiro do Virabrequim
 Lx-Hel 90,00 x 120,00 x 13,00

R

Productos relacionados no incluidos en el juego. Los mismos pueden ser solicitados por separado.

Produtos relacionados não incluídos no jogo. Podem ser solicitados em separado.

Related products that were not included in the set but can be ordered separately.



JVS-347-26
 Juntas Tapa Válvula Sup.(Reforma)
 Juntas Tampa Válvula Superior

DESCRIPCIÓN / Descrição / Description

CHANGAN: Sirion CS/CE/CD/CSB - Ministar CS/CE/CD/CSB - Sirion Utility - Ministar Utility - Sirion Family - Ministar Family

MOTOR / Engine	CM ³	HP	Ø PISTON
JL465QB	970	53	64.00

Juego Completo de Reparación:

Jogo de Juntas do Motor / Full Set Gasket:

JR-736-07

R

Semi-Juego de Reparación:

Semi-Jogo de Juntas / Semi-Set Gasket:

Juego de Descarbonización:

Jogo de Juntas Superior / Head Set Gasket:

JUNTA CULATA DE CILINDROS	TC-730-15	Ø 67.50mm	1.50mm	↑ ↓
Junta de cabeçote				↑ ↓
Cylinder Head gasket				↑ ↓

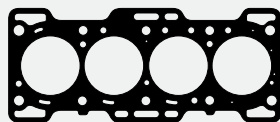

TC-730-15 - 1114175101/2
Junta Culata de Cilindros
Junta Cabeçote



Junta



Junta inspección
Junta inspeção



Salida escape
Saída escapamento



Junta Admisión
Junta Admissão



Junta Escape
Junta Escapamento



Bancada
Traseiro do Virabrequim



Bomba combustible
Bomba combustivel



Junta Tapa Válvula Superior
Junta Tampa Válvula Superior



Bancada
Traseiro do Virabrequim



Bomba de agua
Bomba de água



Bomba de agua
Bomba de água



Junta Cártel
Junta Carter

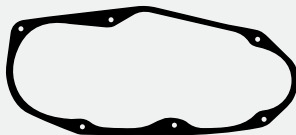

Sobre cárter
Sobre carter



Junta



Junta



Junta



Junta



Junta

Juego Arand. Met. y Goma/Jogo Arru. Met. y Borracha



Juego ret. guía de Válvulas
Jogo Retentor da Haste de Válvulas



Retén Árbol de Levas
Retentor do Eixo Comando de Válvulas
32,00 x 47,00 x 8,00



Retén Distribución
Retentor Dianteiro do Virabrequim
60,00 x 80,00 x 8

R

Productos relacionados no incluidos en el juego. Los mismos pueden ser solicitados por separado.

Produtos relacionados não incluídos no jogo. Podem ser solicitados em separado.

Related products that were not included in the set but can be ordered separately.

Juego Completo de Reparación:

Jogo de Juntas do Motor / Full Set Gasket:

JR-693-07**R**

DESCRIPCIÓN / Descrição / Description

CHERY: QQ 2006/...**Semi-Juego de Reparación:**

Semi-Jogo de Juntas / Semi-Set Gasket:

Juego de Descarbonización:

Jogo de Juntas Superior / Head Set Gasket:

JUNTA CULATA DE CILINDROS	TC-675-07	∅ 73.50mm	1.50mm	↑ ↓
Junta de cabeçote		∅	↑ ↓	↑ ↓
Cylinder Head gasket		∅	↑ ↓	↑ ↓

MOTOR / Engine	CM ³	HP	∅ PISTON
SQR472 16V	1083	67	72.00

ILLINOIS.

CHERY



TC-675-07 - 4721003040AB
Junta Culata de Cilindros
Junta de Cabeçote



Distribución
Distribuição



Chupador de aceite
Pescador de óleo



Junta Admisión
Junta Admissão



Junta Escape
Junta Escapamento



Junta Turbo

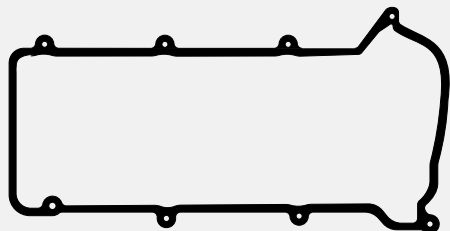

Junta Tapa de Válvula Superior
Junta Tampa de Valvula Superior



Junta Colector
Junta Coletor



Junta



Juego Retenes Guía de Válvulas
Jogo Retentor haste de Válvulas



Retén Bancada
Retentor Traseiro do Virabrequim



Retén Árbol de Leva
Retentor do Eixo Comando de Válvulas



Retén Distribución
Retentor Dianteiro do Virabrequim

Productos relacionados no incluidos en el juego. Los mismos pueden ser solicitados por separado.

Produtos relacionados não incluídos no jogo. Podem ser solicitados em separado.

Related products that were not included in the set but can be ordered separately.

DESCRIPCIÓN / Descrição / Description

CHERY: Face 2007/...

MOTOR / Engine	CM ³	HP	Ø PISTON
SQR473F 16V	1297	82	73.00

Juego Completo de Reparación:

Jogo de Juntas do Motor / Full Set Gasket:

JR-759-11



Semi-Juego de Reparación:

Semi-Jogo de Juntas / Semi-Set Gasket:

Juego de Descarbonización:

Jogo de Juntas Superior / Head Set Gasket:

JUNTA CULATA DE CILINDROS	TC-802-07	Ø 74.70mm	1.50mm	↑ ↓
Junta de cabeçote	TC-802-11	Ø 74.70mm	1.00mm	↑ ↓
Cylinder Head gasket				↑ ↓

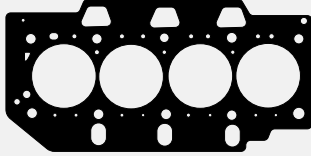

TC-802 - 473H1003080
Junta Culata de Cilindros
Junta Cabeçote



Junta Admisión
Junta Admissão



Junta
Junta

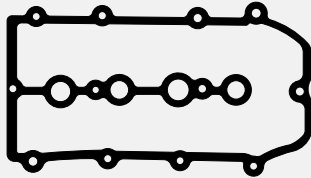

Junta Tapa Válvula Superior
Junta Tampa Válvula Superior



Junta Admisión
Junta Admissão



Junta Escape
Junta Escapamento

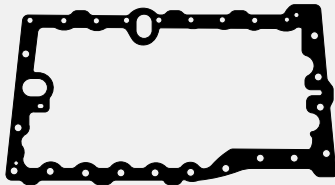

Junta Cártel
Junta Carter



Junta
Junta



Bomba de agua
Bomba de água



Junta
Junta



Bomba combustible
Bomba combustivel



Juego Retenes Guía de Válvulas
Jogo Retentor da Haste de Válvulas



Retén Bancada
Retentor Traseiro do Virabrequim



Retén Árbol de Leva
Retentor do Eixo Comando de Válvulas



Retén Distribución
Retentor Dianteiro do Virabrequim

Productos relacionados no incluidos en el juego. Los mismos pueden ser solicitados por separado.

Produtos relacionados não incluídos no jogo. Podem ser solicitados em separado.

Related products that were not included in the set but can be ordered separately.

Juego Completo de Reparación:

Jogo de Juntas do Motor / Full Set Gasket:

JR-798-11

DESCRIPCIÓN / Descrição / Description

CHERY: Fulwin 2006/...**Semi-Juego de Reparación:**

Semi-Jogo de Juntas / Semi-Set Gasket:

Juego de Descarbonización:

Jogo de Juntas Superior / Head Set Gasket:

JUNTA CULATA DE CILINDROS	TC-669-11	∅ 79.80mm	0.6mm	↑ ↓
Junta de cabeçote		∅	↑ ↓	↑ ↓
Cylinder Head gasket		∅	↑ ↓	↑ ↓

MOTOR / Engine	CM ³	HP	∅ PISTON
SQR477F 16V	1497	107	77.40

ILLINOIS.

CHERY

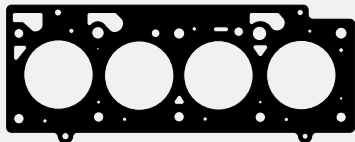

TC-669-11 - 477F1003080
Junta Culata de Cilindros
Junta Cabeçote



Junta Admisión
Junta Admissão



Junta



Junta Tapa Válvula Superior
Junta Tampa Válvula Superior



Junta Escape
Junta Escapamento



Junta Distribución
Junta Distribuição

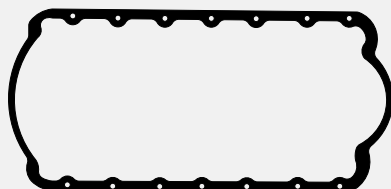

Junta Carter
Junta Cárter



Retén Árbol de Leva
Retenedor do Eixo Comando
de Válvulas



Juego Retenes Guía de Válvulas
Jogo Retenor haste de Válvulas



Retén Bancada
Retenedor Traseiro
do Virabrequim



Retén Distribución
Retenedor Dianteiro
do Virabrequim

Productos relacionados no incluidos en el juego. Los mismos pueden ser solicitados por separado.

Produtos relacionados não incluídos no jogo. Podem ser solicitados em separado.

Related products that were not included in the set but can be ordered separately.

DESCRIPCIÓN / Descrição / Description

CHERY: Tiggo 2010/...

MOTOR / Engine

MOTOR / Engine	CM ³	HP	Ø PISTON
SQR484F 16V	1971	137	83.50
Acteco			

Juego Completo de Reparación:

Jogo de Juntas do Motor / Full Set Gasket:

JR-760

R

Semi-Juego de Reparación:

Semi-Jogo de Juntas / Semi-Set Gasket:

Juego de Descarbonización:

Jogo de Juntas Superior / Head Set Gasket:

JUNTA CULATA DE CILINDROS	TC-803-07	Ø 84.60mm	1.50mm	↑ ↓
Junta de cabeçote	TC-803-11	Ø 84.60mm	1.00mm	↑ ↓
Cylinder Head gasket				↑ ↓

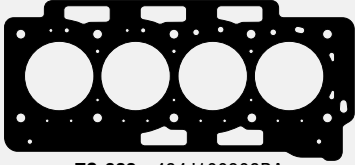

TC-803 - 484J100308BA
Junta Culata de Cilindros
Junta Cabeçote



Junta Admisión
Junta Admissão



Bomba de agua
Bomba de água

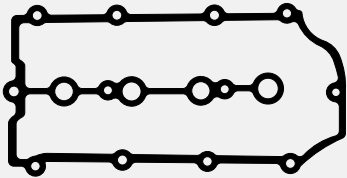

Junta Tapa Válvula Superior
Junta Tampa Válvula Superior



Junta Escape
Junta Escapamento



Bomba combustible
Bomba combustível



Junta Distribución
Junta Distribuição



Junta
Junta



Junta Goma
Junta Borracha



Retén Árbol de Leva
Retentor do Eixo Comando de Válvulas



Juego Retenes Guía de Válvulas
Jogo Retentor da Haste de Válvulas



Retén Bancada
Retentor Traseiro do Virabrequim



Retén Auxiliar
Retentor Auxiliar

Productos relacionados no incluidos en el juego. Los mismos pueden ser solicitados por separado.

Produtos relacionados não incluídos no jogo. Podem ser solicitados em separado.

Related products that were not included in the set but can be ordered separately.

Juego Completo de Reparación:

Jogo de Juntas do Motor / Full Set Gasket:

JR-770-15**R****Semi-Juego de Reparación:**

Semi-Jogo de Juntas / Semi-Set Gasket:

SJ-770**Juego de Descarbonización:**

Jogo de Juntas Superior / Head Set Gasket:

JD-770-15

JUNTA CULATA DE CILINDROS	TC-118-15	∅ 70.00mm	1.50mm	∅
Junta de cabeçote				
Cylinder Head gasket				

DESCRIPCIÓN / Descrição / Description

CHEVROLET: Spark 2003/...
DAEWOO: Tico Matiz 1998/... Damas 1994/...
 (93740053)

MOTOR / Engine	CM ³	HP	∅ PISTON
F8CV	796	52	68.50

ILLINOIS.

CHEV. / DAEWOO

JD-770-15

MENÚ

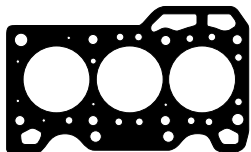

TC-118-15 - 1114178B01
 Junta Culata de Cilindros
 Junta Cabeçote



JAE-623-A
 Junta Admisión
 Junta Admissão



1092000
 Contratapa
 Contra-tampa



JSA-336
 Salida Escape
 Saída Escapamento



JVS-407-43 - 11189A78B000
 Junta Tapa Válvula Superior
 Junta Tampa Válvula Superior



JAE-615-E - 96353036
 Junta Escape
 Junta Escapamento

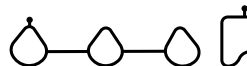

JAE-614-A - 96569405/6
 Junta Admisión
 Junta Admissão



R
 Retén Árbol de Levas
 Retenedor do Eixo
 Comando de Válvulas

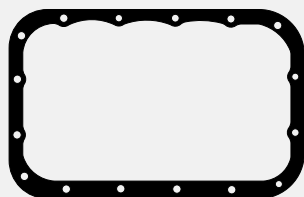

JC-277-30
 Junta Cáster
 Junta Carter

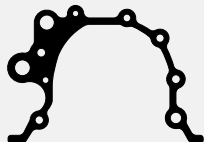

1091700
 Bancada grande
 Mancal grande



1091600
 Bomba de agua
 Bomba de água



R
 Jgo. Ret. Guía de Válvulas
 Jogo Retenedor haste
 de Válvulas



1402500
 Junta



1091800
 Bancada chica
 Mancal pequena



1402600
 Junta



1402700
 Junta



1092100
 Junta Inspección
 Junta Inspeção



1402800
 Junta



2754600
 Junta



R
 Retén Bancada
 Retenedor Traseiro
 do Virabrequim

Productos relacionados no incluidos en el juego. Los mismos pueden ser solicitados por separado.

Produtos relacionados não incluídos no jogo. Podem ser solicitados em separado.

Related products that were not included in the set but can be ordered separately.



BU-168
 Bulones para
 Culata de Cilindros
 Parafusos de Cabeçote

DESCRIPCIÓN / Descrição / Description

CHEVROLET: Sprint
SUZUKI: Swift - Cultus - Van turbo 1984/...
 (1140082810/14)

MOTOR / Engine	CM ³	HP	Ø PISTON
61 - G10 - G10T	993	50	74.00

Juego Completo de Reparación:

Jogo de Juntas do Motor / Full Set Gasket:

JR-507-15

Semi-Juego de Reparación:

Semi-Jogo de Juntas / Semi-Set Gasket:

SJ-507

Juego de Descarbonización:

Jogo de Juntas Superior / Head Set Gasket:

JD-507-15

JUNTA CULATA DE CILINDROS	TC-140-15	Ø 75.00mm	1.60mm	↑ ↓
Junta de cabeçote				↑ ↓
Cylinder Head gasket				↑ ↓



JD-507-15

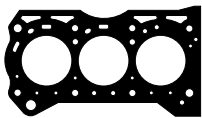

TC-140-15 - 1114182000/01/11
 Junta Culata de Cilindros
 Junta Cabeçote



1087900
 Termostato
 Termostato



JAE-489-E
 Junta Escape
 Junta Escapamento



JAE-488-A
 Junta Admissão
 Junta Admissão



1088000
 Bomba de nafta
 Bomba gasolina

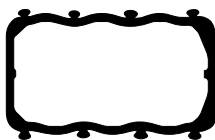

JVS-324-30
 Junta Tapa Válvula Superior
 Junta Tampa Válvula Superior



1088100
 Pipeta termostato
 Pipeta termostato



1088200
 Bomba de agua
 Bomba de água



JC-350-30
 Junta Cártel
 Junta Carter



1088300
 Porta retén delantero
 Flange Dianteiro do Virabrequim



1088400 - 940708530124
 Porta retén trasero
 Flange Traseiro do Virabrequim

Productos relacionados no incluidos en el juego. Los mismos pueden ser solicitados por separado.

Produtos relacionados não incluídos no jogo. Podem ser solicitados em separado.

Related products that were not included in the set but can be ordered separately.

Juego Completo de Reparación:

Jogo de Juntas do Motor / Full Set Gasket:

JR-508-15**Semi-Juego de Reparación:**

Semi-Jogo de Juntas / Semi-Set Gasket:

SJ-508**Juego de Descarbonización:**

Jogo de Juntas Superior / Head Set Gasket:

JD-508-15

JUNTA CULATA DE CILINDROS	TC-109-15	∅ 70.00mm	1.60mm	↑ ↓
Junta de cabeçote				↑ ↓
Cylinder Head gasket				↑ ↓

DESCRIPCIÓN / Descrição / Description

CHEVROLET: Spark 2003/06 - Aveo 2006/...
DAEWOO: Matiz II 2003/06 - Kalos 2000/...
 (93740055)

MOTOR / Engine	CM ³	HP	∅ PISTON
B10S	995	63	68.50
F12S3	1148	71	68.50

ILLINOIS

CHEVROLET

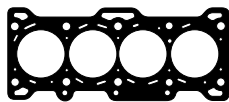
**JD-508-15**

TC-109-15 - 96325170
 Junta Culata de Cilindros
 Junta Cabeçote



1091600
 Bomba de agua
 Bomba de água



JAE-491-E
 Junta Escape
 Junta Escapamento

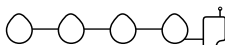

JAE-490-A
 Junta Admissão
 Junta Admissão



2733000
 Depresor
 Depressor



JVS-325-43
 Junta Tapa Válvula Superior
 Junta Tampa Válvula Superior



1092000
 Contratapa
 Contra tampa



1092100
 Junta inspección
 Junta Inspeção



JC-351-26
 Junta Cârtex
 Junta Carter



1091700
 Bancada grande
 Mancal grande



1091800
 Bancada chica
 Mancal pequeno



RT-8629Pol
 Retén Bancada
 Retenedor Traseiro do Virabrequim
 Lx-R 60,00 x 80,00 x 8,00



RT-8627Pol
 Retén Distribución/Árbol de Levas
 Retenedor Dianteiro do Virabrequim e
 do Eixo Comando de Válvulas
 Lx-H 32,00 x 47,00 x 8,00

Productos relacionados no incluidos en el juego. Los mismos pueden ser solicitados por separado.

Produtos relacionados não incluídos no jogo. Podem ser solicitados em separado.

Related products that were not included in the set but can be ordered separately.

DESCRIPCIÓN / Descrição / Description

CHEVROLET: Corsa - Combo - Celta 1990/...
Tigra EFI MPFI - B10 NZ 1994/...

MOTOR / Engine	CM ³	HP	Ø PISTON
OHC	996	60	71.10
C12NZ	1196	45	72.00
12NZ	1196	45	72.00
X12SZ	1196	45	72.00

Juego Completo de Reparación:

Jogo de Juntas do Motor / Full Set Gasket:

JR-478-15

R

Semi-Juego de Reparación:

Semi-Jogo de Juntas / Semi-Set Gasket:

SJ-478

R

Juego de Descarbonización:

Jogo de Juntas Superior / Head Set Gasket:

JD-478-15

R

JUNTA CULATA DE CILINDROS	JUNTA de cabeçote	Cylinder Head gasket	TC-705-15	TC-705-18	TC-705-MG	Ø 74.00mm	Ø 74.00mm	Ø 74.00mm	1.50mm	2.30mm	1.50mm	±0.05	±0.05	±0.05



JD-478-15



TC-705-15 - 90409100
Junta Culata de Cilindros
Junta Cabeçote



2706400
O'ring rectangular 39 x 47 x 4,3mm



1164700 - 90572062
Salida de gases
Saída de gases



JAE-379-A - 90571862
90409709/90106615/96183118
Junta Admisión
Junta Admissão



JAE-401-A - 90323399
Junta Admisión
Junta Admissão



JAE-378-E - 93227660
90409642
Junta Escape
Junta Escapamento

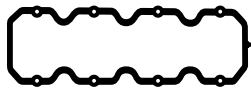

JVS-256-30 - 90354545
90096964
Junta Tapa Válvula Superior
Junta Tampa Válvula Superior



2706900
Guarnición termostato
Guarnição termostato



RT-566Pol
Juego Retenes Guía de Válvulas
Jogo Retentor da Haste de Válvulas

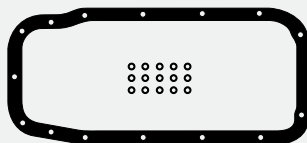

JC-306-30 - 90572656
90409693/93335433
Junta Cártier c/ arandelas limitadoras de apriete
Junta Carter c/ aruelas limitadoras de ajuste



1164600 - 90573301/90353564
Bomba de aceite a block
Bomba de óleo ao bloco



RT-9205Pol
Retén Árbol de Levas
Ret. do Eixo Comando de Válvulas
Lx-R 35,00 x 48,00 x 7,00



JSA-232-21
Salida Escape (Anillo malla acero)
Saída Escapamento (Anel Malha Aço)



1164100 - 90412408
Base TBI



RT-9269Pol
Retén Distribución
Retentor Dianteiro do Virabrequim
Mx-R 26,00 x 42,00 x 8,00



2707200
O'ring 40,87 x 3,53mm



2706800
O'ring bomba de agua/água 79,5 x 3mm



RT-9270Pol
Retén Bancada
Retentor Traseiro do Virabrequim
Lmx-Hel 80,00 x 98,00 x 10,00



2707100
O'ring 40 x 3mm



2707000 - 94632563
O'ring 15,64 x 2,62mm

Productos relacionados no incluidos en el juego. Los mismos pueden ser solicitados por separado
Produtos relacionados não incluídos no jogo. Podem ser solicitados em separado / Related products that were not included in the set but can be ordered separately.



BU-051
BU-052
BU-176
Bulones para Culata de Cilindros
Parafusos de Cabeçote



JAE-378-09
JAE-378-11
Junta Escape
Junta Escapamento



JSA-217
Arandela/Arruela
Suplemento



JVS-256-23
Junta Tapa/Tampa
Válvula Superior



JC-306-15
Junta Cártier
Junta Carter



JC-306-25
Junta Cártier
Junta Carter



JSA-232-22
Salida Escape
Saída Escapamento



1005400 (0,4mm)
1005500 (0,6mm)
Torreta Árbol de Levas
Junta Gaiola



1005600 (0,8mm)
1005700 (1,0mm)
Torreta Árbol de Levas
Junta Gaiola

Juego Completo de Reparación:

Jogo de Juntas do Motor / Full Set Gasket:

JR-731**Semi-Juego de Reparación:**

Semi-Jogo de Juntas / Semi-Set Gasket:

SJ-731**Juego de Descarbonización:**

Jogo de Juntas Superior / Head Set Gasket:

JD-731

JUNTA CULATA DE CILINDROS	TC-705-15	∅ 74.00mm	1.50mm	↑ ↓
Junta de cabeçote	TC-705-MG	∅ 74.00mm	1.50mm	↑ ↓
Cylinder Head gasket	TC-705-18	∅ 74.00mm	2.30mm	↑ ↓

DESCRIPCIÓN / Descrição / Description

CHEVROLET: Onix - Prisma 2013/... - Aveo

MOTOR / Engine	CM ³	HP	∅ PISTON
SPE/4	999	78/80	71.00

ILLINOIS

CHEVROLET

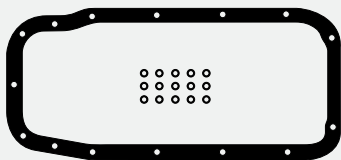
JD-731**TC-705** - 90409100
Junta Culata de Cilindros
Junta Cabeçote**JAE-368-A** - 7084980
Juego Admisión
Jogo Admissão**1164700** - 90572062
Salida de gases
Saída de gases**JAE-379-A** - 90571862
90409709/90106615/96183118
Junta Admisión
Junta Admissão**JAE-378-E** - 93227660
90409642
Junta Escape
Junta Escapamento**2756600**
O'ring 38 x 4mm**JVS-387-43**-24578675
Junta Tapa Válvula Superior
Junta Tampa Válvula Superior**2762600**
O'ring 64 x 3,4mm**2707000**
O'ring 15,64 x 2,62mm**2778800**
Tubo Admisión
Tubo Admissão**JC-306-30** - 90572656
90409693/93335433
Junta Carter c/arandelas limitadoras de apriete
Junta Carter c/arruelas limitadoras de ajuste**RT-594PoI**
Juego Ret. Guía de Válvulas
Jogo Retentor haste de Válvulas**RT-9205PoI**
Retén Árbol de Levas
Retentor do Eixo Comando de Válvulas
Lx-R 35,00 x 48,00 x 7,00**JSA-306** - 73502844/09202367
Junta Salida de Escape
Junta Saída de Escapamento**1164600** - 90573301/90353564
Bomba de aceite a block
Bomba de óleo ao bloco**2706800**
O'ring 79,5 x 3mm**JSA-321** - 94733773
Junta Salida de Escape
Junta Saída de Escapamento**RT-9270PoI**
Retén Bancada
Retentor Traseiro do Virabrequiml
Lmx-R-AH 80,00 x 98,00 x 10,00**RT-9269PoI**
Retén Distribución
Retentor Dianteiro do Virabrequim
Mx-R-H 26,00 x 42,00 x 8,00

Productos relacionados no incluidos en el juego. Los mismos pueden ser solicitados por separado.

Produtos relacionados não incluídos no jogo. Podem ser solicitados em separado.

Related products that were not included in the set but can be ordered separately.

**BU-052**
Bulones para
Culata de Cilindros
Parafusos de Cabeçote

DESCRIPCIÓN / Descrição / Description			
CHEVROLET: Celta 2000/... - Classic			
SUZUKI: Fun 2002/...			
MOTOR / Engine	CM ³	HP	Ø PISTON
C10NE MPFI 8V (SOHC)	999	60	71.10

Juego Completo de Reparación: Jogo de Juntas do Motor / Full Set Gasket:	JR-521-15	R		
Semi-Juego de Reparación: Semi-Jogo de Juntas / Semi-Set Gasket:	SJ-521	R		
Juego de Descarbonización: Jogo de Juntas Superior / Head Set Gasket:	JD-521-15	R		
JUNTA CULATA DE CILINDROS Junta de cabeçote Cylinder Head gasket	TC-705-15 TC-705-18 TC-705-MG	Ø 74.00mm Ø 74.00mm Ø 74.00mm	1.50mm 2.30mm 1.50mm	



JD-521-15



TC-705 - 90409100
Junta Culata de Cilindros
Junta Cabeçote



1194000 - 9050068
Salida de gases
Saída gases



JAE-379-A - 90571862
90409709/90106615/96183118
Junta Admisión
Junta Admissão



JAE-378-E - 90106615
Junta Escape
Junta Escapamento

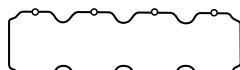

JVS-311-43
638260/7083232/90409594
Junta Tapa Válvula Superior
Junta Tampa Válvula Superior



1181000
Soporte inyección
Suporte injeção



RT-9205Pol
Retén Arbol de Levas
Retenedor do Eixo Comando
de Válvulas
Lx-R 35,00 x 48,00 x 7,00



RT-594Pol
Juego Retenes Guía de Válvulas
Jogo Retenedor da Haste
de Válvulas

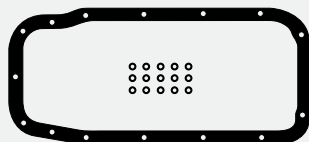

JC-306-30 - 90572656
90409693/93335433
Junta Cártel c/arandelas limitadoras de apriete
Junta Carter c/arruelas limitadoras de ajuste



1164600 - 90573301/90353564
Bomba de aceite a block
Bomba de óleo ao bloco



2706800
O'ring 79,5 x 3mm



1164100 - 90412408
Base TBI



2713600
Anillo de goma
Anel borracha



2713400
O'ring 9,19 x 2,62mm



RT-9270Pol
Retén Bancada
Retenedor Traseiro do Virabrequim
Lmx-Hel 80,00 x 98,00 x 10,00



RT-9269Pol
Retén Distribución
Retenedor Dianteiro do Virabrequim
Mx-R 26,00 x 42,00 x 8,00

Productos relacionados no incluidos en el juego. Los mismos pueden ser solicitados por separado.

Produtos relacionados não incluídos no jogo. Podem ser solicitados em separado.

Related products that were not included in the set but can be ordered separately.



BU-052
Bulones para
Culata de Cilindros
Parafusos de Cabeçote



JC-306-15
Junta Cártel
Junta Carter



JC-306-25
Junta Cártel
Junta Carter

Juego Completo de Reparación:

Jogo de Juntas do Motor / Full Set Gasket:

JR-473-15

DESCRIPCIÓN / Descrição / Description

CHEVROLET: Celta - Classic - Corsa 2003/...**Semi-Juego de Reparación:**

Semi-Jogo de Juntas / Semi-Set Gasket:

SJ-473**Juego de Descarbonización:**

Jogo de Juntas Superior / Head Set Gasket:

JD-473-15

JUNTA CULATA DE CILINDROS	TC-705-15	∅ 74.00mm	≡ 1.50mm	↕ 0.05
Junta de cabeçote	TC-705-18	∅ 74.00mm	≡ 2.30mm	↕ 0.05
Cylinder Head gasket	TC-705-MG	∅ 74.00mm	≡ 1.50mm	↕ 0.05

MOTOR / Engine	CM ³	HP	∅ PISTON
MPFI VHC	999	60	71.10

ILLINOIS

CHEVROLET

**JD-473-15**

TC-705 - 90409100
Junta Culata de Cilindros
Junta Cabeçote



1164700 - 90572062
Salida de gases
Saída de gases



JAE-379-A - 90571862
90409709/90106615/96183118
Junta Admisión
Junta Admissão



JAE-378-E - 93227660
90409642
Junta Escape
Junta Escapamento

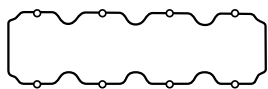

JVS-311-43
638260/7083232/90409594
Junta Tapa Válvula Superior
Junta Tampa Válvula Superior



1181000
Soporte inyección
Suporte injeção



RT-9205PoI
Retén Arbol de Levas
Retentor do Eixo Comando
de Válvulas
Lx-R 35,00 x 48,00 x 7,00



RT-594PoI
Juego Retenes Guía de Válvulas
Jogo Retentor da Haste
de Válvulas

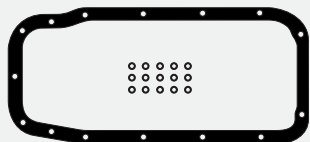

JC-306-30 - 90572656
90409693/93335433
Junta Cártier c/ arandelas limitadoras de apriete
Junta Carter c/ arnuelas limitadoras de ajuste



1164600 - 90573301/90353564
Bomba de aceite a block
Bomba de óleo ao bloco



2706800
O'ring 79,5 x 3mm



2713600
Anillo de goma
Anel borracha



2713400
O'ring 9,19 x 2,62mm



RT-9270PoI
Retén Bancada
Retentor Traseiro do Virabrequim
Lmx-Hel 80,00 x 98,00 x 10,00



RT-9269PoI
Retén Distribución
Retentor Dianteiro do Virabrequim
Mx-R 26,00 x 42,00 x 8,00

Productos relacionados no incluidos en el juego. Los mismos pueden ser solicitados por separado.

Produtos relacionados não incluídos no jogo. Podem ser solicitados em separado.

Related products that were not included in the set but can be ordered separately.



BU-052
Bulones para
Culata de Cilindros
Parafusos de Cabeçote



JC-306-15
JC-306-25
Junta Cártier
Junta Carter



JAE-378-09
JAE-378-11
Junta Escape
Junta Escapamento



1005400 (0,4mm)
1005500 (0,6mm)
Torreta Árbol de Levas
Junta Gaiola

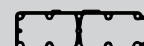

1005600 (0,8mm)
1005700 (1,0mm)
Torreta Árbol de Levas
Junta Gaiola

DESCRIPCIÓN / Descrição / Description

CHEVROLET: Corsa 16V DOHC 1998/...

MOTOR / Engine	CM ³	HP	Ø PISTON
MPFI	999	68	71.00

Juego Completo de Reparación:

Jogo de Juntas do Motor / Full Set Gasket:

JR-522-15

R

Semi-Juego de Reparación:

Semi-Jogo de Juntas / Semi-Set Gasket:

SJ-522

R

Juego de Descarbonización:

Jogo de Juntas Superior / Head Set Gasket:

JD-522-15

R

JUNTA CULATA DE CILINDROS	TC-896-15	Ø74.00mm	1.50mm	↑ ↓
Junta de cabeçote		Ø	↑ ↓	↑ ↓
Cylinder Head gasket		Ø	↑ ↓	↑ ↓



JD-522-15



TC-896-15 - 90502404
Junta Tapa de Cilindros
Junta Cabeçote



JSA-250 - 90128293/854933/94649659
Salida Escape
Saída Escapamento



1099800
Termostato



JAE-453-A - 850668/90502462
Junta Admisión
Junta Admissão



JAE-452-E - 5850613/90470036
Junta Escape
Junta Escapamento



1099700
Junta TBI

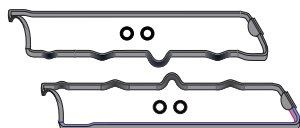

JVS-274-43 - 638736/37
90501525
Junta Tapa Válvula Superior c/arandelas
Junta Tampa Válvula Superior
c/arruelas



1193900 - 5850612/90470434
Entre múltiple colector
Entre coletor



2748000
O'ring 9 x 2mm



1193800 - 5050611
Entre múltiple colector
Entre coletor



RT-581PoI
Juego Retenes Guía de Válvulas
Jogo Ret. da Haste de Válvulas



RT-9205PoI
Retén Arbol de Levas
Ret. do Eixo Comando de Válv.
Lx-R 35,00 x 48,00 x 7,00

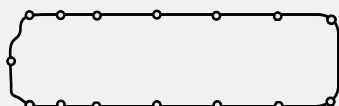

JC-335-43 - 652669/90412846
Junta Carter
Junta Carter



1164600 - 90573301/90353564
Bomba de aceite a block
Bomba de óleo ao bloco



2713500
O'ring 64 x 3mm



2706800
O'ring 79,5 x 3mm



2609300
Arandela 14 x 19 x 1,5mm
Arruela (Aluminio)



2704100
O'ring 55,25 x 2,62mm



2706300
O'ring 60 x 1,78mm



1194000 - 9050068
Salida de gases
Saída de gases



RT-9270PoI
Retén Bancada
Retentor Traseiro do Virabrequim
Lmx-Hel 80,00 x 98,00 x 10,00



RT-9269PoI
Retén Distribución
Retentor Dianteiro do Virabrequim
Mx-R 26,00 x 42,00 x 8,00

Productos relacionados no incluidos en el juego. Los mismos pueden ser solicitados por separado.

Produtos relacionados não incluídos no jogo. Podem ser solicitados em separado.

Related products that were not included in the set but can be ordered separately.



BU-002
Bulones para Culata de Cilindros
Parafusos de Cabeçote



JSA-250-11
Salida Escape (Láminas)
Saída Escapamento (Camadas)

Juego Completo de Reparación:

Jogo de Juntas do Motor / Full Set Gasket:

JR-771-15**Semi-Juego de Reparación:**

Semi-Jogo de Juntas / Semi-Set Gasket:

SJ-771**Juego de Descarbonización:**

Jogo de Juntas Superior / Head Set Gasket:

JD-771-15

JUNTA CULATA DE CILINDROS	TC-680-15	∅ 71.00mm	1.50mm	↕
Junta de cabeçote		∅		↕
Cylinder Head gasket		∅		↕

DESCRIPCIÓN / Descrição / Description

CHEVROLET: Spark 2010/... - Aveo 2007/...
DAEWOO: Matiz 2010/...

MOTOR / Engine	CM ³	HP	∅ PISTON
73 CID LMU	1206	82	69.70
B12D1	1206	84	69.70

ILLINOIS.

CHEV. / DAEWOO

JD-771-15

TC-680-15 - 96941107
Junta Culata de Cilindros
Junta Cabeçote



JAE-616-A - 96416314
Junta Admisión
Junta Admissão



1187700
Junta

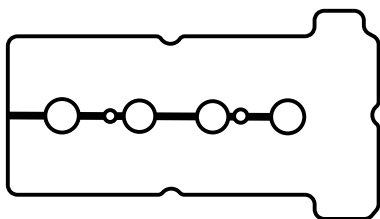

JVS-408-43 - 96416270
Junta Tapa Válvula Superior
Junta Tampa Válvula Superior



JAE-617-E - 96416309
Junta Escape
Junta Escapamento



1185900
Válvula EGR



1136900
Distribución
Distribuição



1003400
Junta Inspección
Junta Inspeção



2776700
Junta

Productos relacionados no incluidos en el juego. Los mismos pueden ser solicitados por separado.

Produtos relacionados não incluídos no jogo. Podem ser solicitados em separado.

Related products that were not included in the set but can be ordered separately.

DESCRIPCIÓN / Descrição / Description

CHEVROLET: Corsa D - Astra

MOTOR / Engine	CM ³	HP	Ø PISTON
A14NEL/NET	1364	118/138	72.50

Juego Completo de Reparación:

Jogo de Juntas do Motor / Full Set Gasket:

JR-652-11

R

Semi-Juego de Reparación:

Semi-Jogo de Juntas / Semi-Set Gasket:

Juego de Descarbonización:

Jogo de Juntas Superior / Head Set Gasket:

JUNTA CULATA DE CILINDROS	TC-668-11	Ø 73.50mm	0.60mm	↑	↓
Junta de cabeçote				↑	↓
Cylinder Head gasket				↑	↓

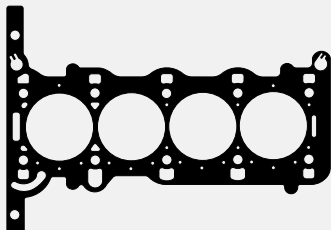

TC-668-11 - 55562233/607161
Junta Culata de Cilindros
Junta Cabeçote



Bomba de agua
Bomba de água



Salida Escape
Saída Escapamento



Junta Escape
Junta Escapamento



Junta Admisión
Junta Admissão



Junta

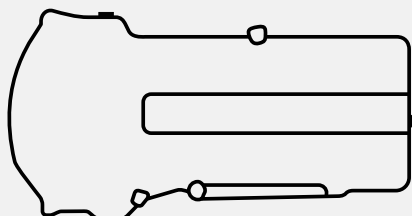

Junta Tapa Válvula Superior
Junta Tampa Válvula Superior

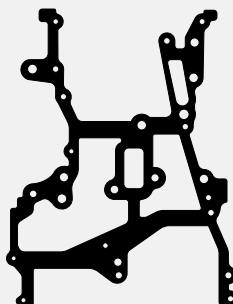

Distribución
Distribuição



Junta



Retén Bancada
Retentor Traseiro do Virabrequim



Retén Distribución
Retentor Dianteiro do Virabrequim



Juego Retenes Guía de Válvulas
Jogo Retentor da Haste de Válvulas

R

Productos relacionados no incluidos en el juego. Los mismos pueden ser solicitados por separado.

Produtos relacionados não incluídos no jogo. Podem ser solicitados em separado.

Related products that were not included in the set but can be ordered separately.

Juego Completo de Reparación:

Jogo de Juntas do Motor / Full Set Gasket:

JR-373**R****Semi-Juego de Reparación:**

Semi-Jogo de Juntas / Semi-Set Gasket:

SJ-374**R****Juego de Descarbonización:**

Jogo de Juntas Superior / Head Set Gasket:

JD-168**R**

JUNTA CULATA DE CILINDROS	TC-597-15	∅ 79.30mm	1.50mm	∅
Junta de cabeçote	TC-597-MG	∅ 79.30mm	1.50mm	∅
Cylinder Head gasket				

DESCRIPCIÓN / Descrição / Description

CHEVROLET: Corsa GL EFI - Kadett E 1986/91
Cavalier 1986/94 - Ascona C 1986/88
Astra 1986/93 - Vectra A - Chevy (90442264)

MOTOR / Engine	CM ³	HP	∅ PISTON
C14NZ/NV	1389	60/75	77.60
OHC	1389	60/75	77.60

ILLINOIS

CHEVROLET

**JD-168**

TC-597- 90322816/90541019
Junta Culata de Cilindros
Junta Cabeçote



1160400 - 90500068
Salida de gases 1,6
Saída de gases



1164700 - 90572062
Salida de gases 1,4
Saída de gases



JAE-379-A - 90571862
90409709/90106615/96183118
Junta Admisión
Junta Admissão



JAE-378-E - 93227660
90409642
Junta Escape
Junta Escapamento



JAE-401-A - 90323399
Junta Admisión
Junta Admissão



2706900
Guarnición termostato
Guarnição termostato



JVS-256-30 - 90354545
90096964
Junta Tapa Válvula Superior
Junta Tampa Válvula Superior



2706400
O'ring rectangular
O'ring retangular
39 x 47 x 4,3mm



RT-9205PoI
Retén Árbol de Levas
Ret. do Eixo Comando de Válv.
Lx-R 35,00 x 48,00 x 7,00

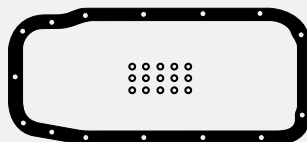

RT-566PoI
Jgo. Ret. Guía de Válvulas
Jogo Retentor da Haste
de Válvulas

R

JC-306-30 - 90572656
90409693/93335433
Junta Carter
c/arandelas limitadoras de apriete
Junta Carter c/arruelas limitadoras de ajuste



1164600 - 90573301/90353564
Bomba de aceite a block
Bomba de óleo ao bloco



1164100 - 90412408
Base TBI
Base TBI



JSA-232-21
Salida Escape (Anillo malla acero)
Saída Escapamento
(Anel malha aço)



2706800
O'ring bomba de agua 79,5 x 3mm
O'ring bomba de água



2707200
O'ring 40,87 x 3,53mm



2707100
O'ring 40 x 3mm



2707000 - 94632563
O'ring 15,64 x 2,62mm



2606900 - N0138492
Arandela 14 x 20 x 1,5mm
Arruela (Cobre)



RT-9270PoI
Retén Bancada
Retentor Traseiro do Virabrequim
Lmx-Hel 80,00 x 98,00 x 10,00



RT-9269PoI
Retén Distribución
Retentor Dianteiro do Virabrequim
Mx-R 26,00 x 42,00 x 8,00

R

Productos relacionados no incluidos en el juego. Los mismos pueden ser solicitados por separado

Produtos relacionados não incluídos no jogo. Podem ser solicitados em separado / Related products that were not included in the set but can be ordered separately.



BU-051
BU-176
BU-052
Bulones para Culata
de Cilindros
Parafusos de Cabeçote



JAE-378-09
JAE-378-11
Junta Escape
Junta Escapamento



JSA-217
Arandela Suplemento
Arruela Suplemento



JVS-256-23
Junta Tapa Válvula Superior
Junta Tampa Válvula Superior



1005400 (0,4mm)
1005500 (0,6mm)
Torreta Árbol de Levas
Junta Gaiola

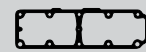

1005600 (0,8mm)
1005700 (1,0mm)
Torreta Árbol de Levas
Junta Gaiola



JSA-232-22
Salida Escape
Saída Escapamento



JC-306-15
Junta Carter
Junta Carter



JC-306-25
Junta Carter
Junta Carter

DESCRIPCIÓN / Descrição / Description

CHEVROLET: Corsa A/B 1991/97 - Combo1993/...
Swing 1994/98 - Chevy Popular 1995/... - Corsa
Astra 1991/98 - Celta MPFI 2004/... - Montana
Ecoflex 2007/...

MOTOR / Engine	CM ³	HP	Ø PISTON
C14SE - X14NZ	1389	60/82	77.60
LQ5	1389	85/97	77.60

Juego Completo de Reparación:

Jogo de Juntas do Motor / Full Set Gasket:

JR-540

R

Semi-Juego de Reparación:

Semi-Jogo de Juntas / Semi-Set Gasket:

SJ-540

R

Juego de Descarbonización:

Jogo de Juntas Superior / Head Set Gasket:

JD-540

R

JUNTA CULATA DE CILINDROS	TC-597-15	Ø 79.30mm	1.50mm	±0.05
Junta de cabeçote	TC-597-MG	Ø 79.30mm	1.50mm	±0.05
Cylinder Head gasket				



JD-540



TC-597 - 90322816/90541019
Junta Culata de Cilindros
Junta Cabeçote



JAE-401-A - 90323399
Junta Admissão
Junta Admissão



1164700 - 90572062
Saída de gases
Saída gases



JAE-379-A - 90571862
90409709/90106615/96183118
Junta Admissão
Junta Admissão



JAE-378-E - 93227660
90409642
Junta Escape
Junta Escapamento



RT-566Pol
Juego Retenes Guía de Válvulas
Jogo Retedor da Haste
de Válvulas

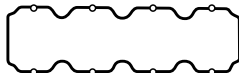

JVS-311-43
638260/7083232/90409594
Junta Tapa Válvula Superior
Junta Tampa Válvula Superior



1181000
Soporte inyección
Suporte injeção



RT-9205Pol
Retén Árbol de Levas
Retedor do Eixo Comando
de Válvulas
Lx-R 35,00 x 48,00 x 7,00

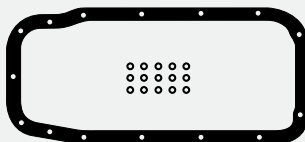

JC-306-30 - 90572656
90409693/93335433
Junta Cártel
c/arandelas limitadoras de apriete
Junta Carter
c/arruelas limitadoras de ajuste



1164600 - 90573301/90353564
Bomba de aceite a block
Bomba de óleo ao bloco



2706800
O'ring 79,5 x 3mm



2713600
Anillo de goma
Anel de borracha



RT-9270Pol
Retén Bancada
Retedor Traseiro do Virabrequim
Lmx-Hel 80,00 x 98,00 x 10,00



RT-9269Pol
Retén Distribución
Retedor Dianteiro do Virabrequim
Mx-R 26,00 x 42,00 x 8,00

Productos relacionados no incluidos en el juego. Los mismos pueden ser solicitados por separado
Produtos relacionados não incluídos no jogo. Podem ser solicitados em separado / Related products that were not included in the set but can be ordered separately.



BU-051
BU-176
BU-052
Bulones para Culata
de Cilindros
Parafusos de Cabeçote



JC-306-15
JC-306-25
Junta Cártel
Junta Carter



JAE-378-09
JAE-378-11
Junta Escape
Junta Escapamento



1005400 (0,4mm)
1005500 (0,6mm)
Torreta Árbol de Levas
Junta Gaiola



1005600 (0,8mm)
1005700 (1,0mm)
Torreta Árbol de Levas
Junta Gaiola

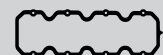

JVS-256-23
JVS-256-30
Junta Tapa Válvula Superior
Junta Tampa Válvula Superior

Juego Completo de Reparación:

Jogo de Juntas do Motor / Full Set Gasket:

JR-597**Semi-Juego de Reparación:**

Semi-Jogo de Juntas / Semi-Set Gasket:

SJ-597**Juego de Descarbonización:**

Jogo de Juntas Superior / Head Set Gasket:

JD-597

JUNTA CULATA DE CILINDROS	TC-597-15	Ø 79.30mm	1.50mm	1.50mm
Junta de cabeçote	TC-597-MG	Ø 79.30mm	1.50mm	1.50mm
Cylinder Head gasket				

DESCRIPCIÓN / Descrição / Description

CHEVROLET: Corsa Econoflex - Classic
Agile 2009/... - Celta 2006/09

MOTOR / Engine	CM ³	HP	Ø PISTON
X14SE/Y14NE	1389	90/92	77.60

ILLINOIS

CHEVROLET

JD-597

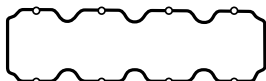
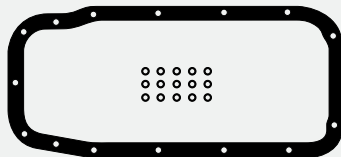
**TC-597** - 90322816/90541019
Junta Culata de Cilindros
Junta Cabeçote**JAE-368-A** - 7084980
Junta Admissão
Junta Admissão**1164700** - 90572062
Saída de gases
Saída de gases**2710200** - 71716584/7086225
Sensor temperatura de água
Sensor temperatura de água
(Admissão/Admissão)**JAE-378-E** - 93227660
90409642
Junta Escape
Junta Escapamento**JSA-306** - 73502844/09202367
55557507
Saída Escape
Saída Escapamento**RT-594Pol**
Juego Retenes Guía de Válvulas
Jogo Retentor Haste de Válvulas**JVS-311-43**
Junta Tapa Válvula Superior
Junta Tampa Válvula Superior**1181000**
Soporte inyección
Suporte injeção**RT-9205Pol**
Retén Árbol de Levas
Retentor do Eixo Comando de Válvulas
Lx-R 35,00 x 48,00 x 7,00**JC-306-30** - 90572656
90409693/93335433
Junta Cártier c/arruelas limitadoras de apriete
Junta Carter c/arruelas limitadoras de ajuste**1164600** - 90573301/90353564
Bomba de aceite a block
Bomba de óleo ao bloco**2706800**
O'ring 79,5 x 3mm**2713600**
Anillo de goma
Anel de borracha**RT-9270Vit**
Retén Bancada
Retentor Traseiro do Virabrequim
Lmx-Hel 80,00 x 98,00 x 10,00**RT-9269Pol**
Retén Distribución
Retentor Dianteiro do Virabrequim
Mx-R 26,00 x 42,00 x 8,00

Productos relacionados no incluídos en el juego. Los mismos pueden ser solicitados por separado.

Produtos relacionados não incluídos no jogo. Podem ser solicitados em separado.

Related products that were not included in the set but can be ordered separately.

**BU-238**
Bulones p/Culata
Parafusos de Cabeçote**JC-306-15**
JC-306-25
Junta Cártier
Junta Carter**JAE-378-09**
JAE-378-11
Junta Escape
Junta Escapamento

DESCRIPCIÓN / Descrição / Description			
CHEVROLET: Onix 2013/... - Prisma 2013/... - Aveo			
MOTOR / Engine	CM ³	HP	Ø PISTON
SPE/4	1389	106	77.60

Juego Completo de Reparación: Jogo de Juntas do Motor / Full Set Gasket:	JR-732	R		
Semi-Juego de Reparación: Semi-Jogo de Juntas / Semi-Set Gasket:	SJ-731	R		
Juego de Descarbonización: Jogo de Juntas Superior / Head Set Gasket:	JD-732	R		
JUNTA CULATA DE CILINDROS	TC-597-15	Ø 79.30mm	1.50mm	±0.05
Junta de cabeçote	TC-597-MG	Ø 79.30mm	1.50mm	±0.05
Cylinder Head gasket				



JD-732



TC-597 - 90322816/90541019
Junta Culata de Cilindros
Junta Cabeçote



JAE-368-A - 7084980
Juego Admisión
Jogo Admissão



1164700 - 90572062
Salida de gases
Saída de gases



JAE-379-A - 90571862
90409709/90106615/96183118
Junta Admisión
Junta Admissão



JAE-378-E - 93227660
90409642
Junta Escape
Junta Escapamento



2756600
O'ring 38 x 4mm



JVS-387-43-24578675
Junta Tapa de Válvula Superior
Junta Tampa de Válvula Superior



2762600
O'ring 64 x 3,4mm

2707000
O'ring 15,64 x 2,62mm



2778800
Tubo Admisión
Tubo Admissão

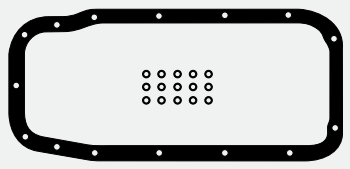

JC-306-30 - 90572656
90409693/93335433
Junta Cártier c/arandelas limitadoras de apriete
Junta Carter c/arruelas limitadoras de ajuste



RT-594Po1
Juego Ret. Guía de Válvulas
Jogo Retenedor da Haste de Válvulas



RT-9205Po1
Retén Árbol de Levas
Retenedor do Eixo Comando de Válv.
Lx-R 35,00 x 48,00 x 7,00



JSA-306- 73502844/09202367
Junta Salida de Escape
Junta Saída de Escapamento



1164600 - 90573301/90353564
Bomba de aceite a block
Bomba de óleo ao bloco



2706800
O'ring 79,5 x 3mm



JSA-321- 94733773
Junta Salida de Escape
Junta Saída de Escapamento



RT-9270Po1
Retén Bancada
Retenedor Traseiro do Virabrequim
Lmx-R-AH 80,00 x 98,00 x 10,00



RT-9269Po1
Retén Distribución
Retenedor Dianteiro do Virabrequim
Mx-R-H 26,00 x 42,00 x 8,00

Productos relacionados no incluidos en el juego. Los mismos pueden ser solicitados por separado.
Produtos relacionados não incluídos no jogo. Podem ser solicitados em separado.
Related products that were not included in the set but can be ordered separately.



BU-052
Bulones para Culata de Cilindros
Parafusos de Cabeçote

Juego Completo de Reparación:

Jogo de Juntas do Motor / Full Set Gasket:

JR-335-15

DESCRIPCIÓN / Descrição / Description

CHEVROLET: Chevette 1973/89 - GM
(7329442/96622395)**Semi-Juego de Reparación:**

Semi-Jogo de Juntas / Semi-Set Gasket:

SJ-335**Juego de Descarbonización:**

Jogo de Juntas Superior / Head Set Gasket:

JD-335-15

JUNTA CULATA DE CILINDROS	TC-525-15	∅ 84.00mm	1.50mm	∓
Junta de cabeçote	TC-525-18	∅ 84.00mm	2.30mm	∓
Cylinder Head gasket				

MOTOR / Engine	CM ³	HP	∅ PISTON
GMC 85	1393	45	82.00
GMC 98	1599	71	82.00

ILLINOIS

CHEVROLET

**JD-335-15****TC-525 - 94601825**
Junta Culata de Cilindros
Junta Cabeçote**JSA-275 - 9308295**
Salida Escape
Saída Escapamento**JAE-444-A - 8966825**
Junta Admisión
Junta Admissão**JAE-443-E - 8966704**
Junta Escape
Junta Escapamento**RT-545Pol - 94634714**
Juego Retenes Guía de Válvulas
Jogo Retentor da Haste de Válvulas**JVS-294-30 - 8966782/52253106**
Junta Tapa Válvula Superior c/arruelas
Junta Tampa Válvula Superior c/arruelas**1192800 - 8966853**
Base termostato
Base termostato**1192900 - 8930191**
Base carburador**JC-330-30 - 8966813**
Junta Cártier
Junta Carter**1192700 - 8966851**
Bomba de agua
Bomba de água**1192600 - 8966792**
Tapa distribución frontal
Tampa distribuição frontal**1193100 - 8966812**
Bomba de aceite
Bomba de óleo**1193200 - 8966864**
Arandela termostato
Arruela termostato**1193000 - 8981886**
Árbol de levas
Árvore de comando**1193300 - 8930353**
90265732/90275602/9275602
Bomba de nafta
Bomba gasolina**2610600 - 105452**
Arandela 14 x 20 x 1,5mm
Arruela (Aluminio)**2705600**
Tubo
16 x 22,5 x 7,7mm**RT-8450Pol - 8966754**
Retén Bancada
Retentor Traseiro do Virabrequim
Lx-Hel 75,90 x 95,00 x 11,30**RT-8032Pol - 94648817**
Retén Distribución
Retentor Dianteiro do Virabrequim
Lx-R 45,00 x 60,00 x 10,00

Productos relacionados no incluidos en el juego. Los mismos pueden ser solicitados por separado.

Produtos relacionados não incluídos no jogo. Podem ser solicitados em separado.

Related products that were not included in the set but can be ordered separately.

**JB-229**
Juego Carburador
Jogo Carburador**JB-230**
Juego Carburador
Jogo Carburador**JC-330-26**
Junta Cártier
Junta Carter**JSA-278-21 - 9302783**
Salida Escape
Saída Escapamento

DESCRIPCIÓN / Descrição / Description

CHEVROLET: Sail 2010/15

MOTOR / Engine	CM ³	HP	Ø PISTON
LCU S-TEC III 16V DOHC	1399	103	73.80

Juego Completo de Reparación:

Jogo de Juntas do Motor / Full Set Gasket:

JR-562-15

Semi-Juego de Reparación:

Semi-Jogo de Juntas / Semi-Set Gasket:

SJ-562

Juego de Descarbonización:

Jogo de Juntas Superior / Head Set Gasket:

JUNTA CULATA DE CILINDROS	TC-797-15	Ø 75.00mm	1.50mm	↕
Junta de cabeçote	TC-797-MG	Ø 75.00mm	1.50mm	↕
Cylinder Head gasket				↕

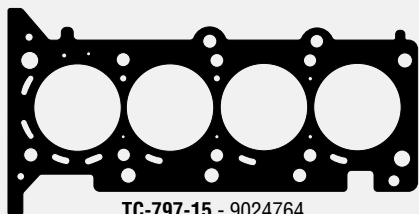

TC-797-15 - 9024764
Junta Culata de Cilindros
Junta Cabeçote



2776600
Termostato



JAE-611-A - 09025168
Junta Admisión
Junta Admissão



JAE-612-E - 24102279
Junta Escape
Junta Escapamento

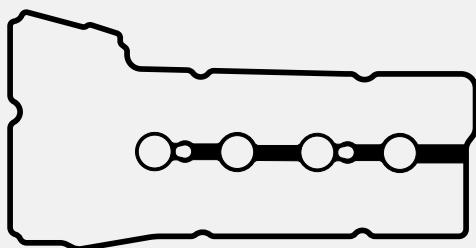

JVS-404-43 - 9024064
Junta Tapa Válvula Superior c/arandelas
Junta Tampa Válvula Superior c/arruelas

Productos relacionados no incluidos en el juego. Los mismos pueden ser solicitados por separado.

Produtos relacionados não incluídos no jogo. Podem ser solicitados em separado.

Related products that were not included in the set but can be ordered separately.

Juego Completo de Reparación:

Jogo de Juntas do Motor / Full Set Gasket:

JR-800-11

DESCRIPCIÓN / Descrição / Description

CHEVROLET: Cruze - Tracker 2017/...**Semi-Juego de Reparación:**

Semi-Jogo de Juntas / Semi-Set Gasket:

Juego de Descarbonización:

Jogo de Juntas Superior / Head Set Gasket:

JUNTA CULATA DE CILINDROS	TC-667-11	∅ 75.20mm	1.00mm	↑ ↓
Junta de cabeçote				↑ ↓
Cylinder Head gasket				↑ ↓

MOTOR / Engine	CM ³	HP	∅ PISTON
LE2	1399	153	74.00

ILLINOIS.

CHEVROLET

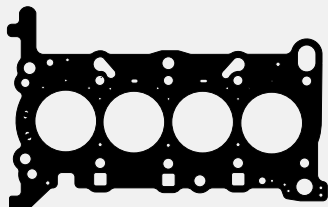

TC-667-11 - 12663440
Junta Culata de Cilindros
Junta Cabeçote



Juego Admisión
Jogo Admissão



Junta Admisión
Junta Admissão



Junta Tapa Válvula Superior
Junta Tampa Válvula Superior



Junta Escape
Junta Escapamento



Salida Escape
Saída Escapamento

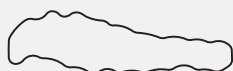

Distribución
Distribuição



Retén Distribución
Retentor Dianteiro do
Virabrequim



Juego Retenes Guía de Válvulas
Jogo Retentor da Haste de Válvulas



Retén Bancada
Retentor Traseiro do Virabrequim

Productos relacionados no incluidos en el juego. Los mismos pueden ser solicitados por separado.

Produtos relacionados não incluídos no jogo. Podem ser solicitados em separado.

Related products that were not included in the set but can be ordered separately.

DESCRIPCIÓN / Descrição / Description

CHEVROLET: Nubira 2003/05 - Optra Aveo MPI 2004/...
DAEWOO: Kalos - Lacetti 2004/... Nubira 2003/05

MOTOR / Engine	CM ³	HP	Ø PISTON
F14 D3	1399	94	77.90
F16 D3 (DOHC 16V)	1598	103/109	79.00
Descarga simple			

Juego Completo de Reparación:

Jogo de Juntas do Motor / Full Set Gasket:

JR-551

R

Semi-Juego de Reparación:

Semi-Jogo de Juntas / Semi-Set Gasket:

SJ-551

R

Juego de Descarbonización:

Jogo de Juntas Superior / Head Set Gasket:

JD-551

R

JUNTA CULATA DE CILINDROS	TC-795-15	Ø 80.50mm	1.20mm	1.20mm	1.20mm
Junta de cabeçote	TC-795-MG	Ø 80.50mm	1.20mm	1.20mm	1.20mm
Cylinder Head gasket					



JD-551



TC-795 - 96378802
Junta Culata de Cilindros
Junta Cabeçote



2706800
O'ring 79,5 x 3mm



2755400 - 96376371
Guarnição comando aceleração
Guarnição comando aceleração



JAE-561-A - 96461130
Juego Admisión
Jogo Admissão



JAE-562-E - 96378805
Junta Escape
Junta Escapamento



JAE-563-A
Junta Escape
Junta Escapamento

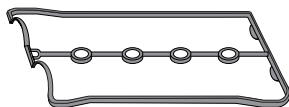

JVS-365-43 - 96353002
Junta Tapa Válvula Superior
Junta Tampa Válvula Superior



RT-8038PoI
Retén Distribución
Retentor Dianteiro do Virabrequim
Lx-Hel 42,00 x 56,00 x 7,00



RT-2959Vit
Juego Retenes Guía de Válvulas
Jogo Retentor da Haste de Válvulas



JC-306-25 - 90572656
90409693/93335433
Junta Carter
Junta Carter



1164600 - 90573301
90353564
Bomba de aceite a block
Bomba de óleo ao bloco



1166100
Junta



1166900
Junta



1177300 - 129799/94649659
Base carburador brosol
Base carburador brosol



1134600
Junta



1133800
Junta



JSA-313
Salida Escape
Saída Escapamento

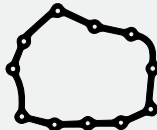

1125000
Junta



1168600
Junta



1168800
Junta



RT-9270PoI - 93309906
Retén Bancada
Retentor Traseiro do Virabrequim
Lmx-Hel 80,00 x 98,00 x 10,00



RT-6690PoI
Retén Distribución
Retentor Dianteiro do Virabrequim
Lz-R 30,00 x 42,00 x 7,00

Productos relacionados no incluidos en el juego. Los mismos pueden ser solicitados por separado.

Produtos relacionados não incluídos no jogo. Podem ser solicitados em separado.

Related products that were not included in the set but can be ordered separately.



BU-171
Bulones para Culata de Cilindros
Parafusos de Cabeçote



JC-306-15
Junta Carter
Junta Carter



JC-306-30
Junta Carter
Junta Carter

Juego Completo de Reparación:

Jogo de Juntas do Motor / Full Set Gasket:

JR-552**R****Semi-Juego de Reparación:**

Semi-Jogo de Juntas / Semi-Set Gasket:

SJ-551**R****Juego de Descarbonización:**

Jogo de Juntas Superior / Head Set Gasket:

JD-552**R**

JUNTA CULATA DE CILINDROS	TC-796-15	∅ 80.50mm	1.20mm	±0.05
Junta de cabeçote	TC-796-MG	∅ 80.50mm	1.20mm	±0.05
Cylinder Head gasket	TC-796-18	∅ 80.50mm	2.30mm	±0.05

DESCRIPCIÓN / Descrição / Description

CHEVROLET: Nubira 2003/05 - Optra

Aveo MPI 2004/...

DAEWOO: Kalos - Lacetti 2004/...

Nubira 2003/05

MOTOR / Engine	CM ³	HP	∅ PISTON
F14 D3	1399	94	77.90
F16 D3	1598	103/109	79.00
(DOHC 16V)			
Descarga doble			

ILLINOIS

CHEVROLET

JD-552

**TC-796**Junta Culata de Cilindros
Junta Cabeçote**2706800**

O'ring 79,5 x 3mm

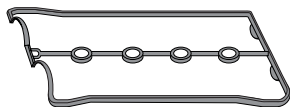
**2755400 - 96376371**Guarnición comando aceleración
Guarnição comando aceleração**JAE-561-A - 96461130**Juego Admisión
Jogo Admissão**JAE-562-E - 96378805**Junta Escape
Junta Escapamento**JAE-563-A**Junta Escape
Junta Escapamento**JVS-365-43 - 96353002**Junta Tapa Válvula Superior
Junta Tampa Válvula Superior**RT-8038Pol**Retén Árbol de levas
Ret. do Eixo Comando de Válvulas
Lx-Hel 42,00 x 56,00 x 7,00**RT-2959Vit**Juego Retenes Guía de Válvulas
Jogo Retentor da Haste
de Válvulas**JC-306-25 - 90572656**

90409693/93335433

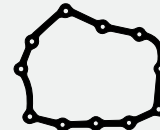
Junta Carter
Junta Carter**JSA-313**Salida Escape
Saída Escapamento**1177300 - 129799/94649659**Base carburador Brosol
Base carburador Brosol**1125000**

Junta

**1164600 - 90573301**

90353564

Bomba de aceite a block
Bomba de óleo ao bloco**1134600**

Junta

**1133800**

Junta

**1166100**

Junta

**1168800**

Junta

**1168600**

Junta

**1166900**

Junta

**RT-9270Pol - 93309906**Retén Bancada
Retentor Traseiro do Virabrequim
Lmx-Hel 80,00 x 98,00 x 10,00**RT-6690Pol**Retén Distribución
Retentor Dianteiro do Virabrequim
Lz-R 30,00 x 42,00 x 7,00

Productos relacionados no incluidos en el juego. Los mismos pueden ser solicitados por separado.

Produtos relacionados não incluídos no jogo. Podem ser solicitados em separado.

Related products that were not included in the set but can be ordered separately.

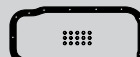
**BU-171**Bulones para
Culata de Cilindros
Parafusos Cabeçote**JC-306-15**Junta Carter
Junta Carter**JC-306-30**Junta Carter
Junta Carter

DESCRIPCIÓN / Descrição / Description

CHEVROLET: Cruze 1.8 2008/... - Aveo 1.4 2009/...
FIAT: Cromia 2005/...
OPEL: Astra H 2004/... - Signum Vectra C 2006/...
 Zafira B 2005/... - Insignia 2008/...
ALFA ROMEO: 159 2005/...

MOTOR / Engine	CM ³	HP	Ø PISTON
F14D4 (DOHC 16V)	1399	101	80.50
F18D4 (DOHC 16V)	1796	141	80.50
Z18XER/A18XER	1796	141	80.50
939A4 (DOHC 16V)	1796	140	80.50

Juego Completo de Reparación:

Jogo de Juntas do Motor / Full Set Gasket:

JR-559

R

Semi-Juego de Reparación:

Semi-Jogo de Juntas / Semi-Set Gasket:

SJ-559

R

Juego de Descarbonización:

Jogo de Juntas Superior / Head Set Gasket:

JD-559

R

JUNTA CULATA DE CILINDROS	TC-957-15	Ø 82.00mm	1.50mm	1.50mm	1.50mm
Junta de cabeçote	TC-957-MG	Ø 82.00mm	1.50mm	1.50mm	1.50mm
Cylinder Head gasket					



JD-559



TC-957 - 93186222/55355578
 Junta Culata de Cilindros
 Junta Cabeçote



JAE-608-A - 55568787/850948
 Junta Admisión
 Junta Admissão

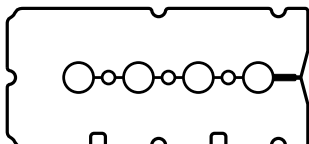

JVS-403-43 - 55354237
 Junta Tapa Válvula Superior
 Junta Tampa Válvula Superior



2775800
 Guarnición termostato
 Guarnição termostato



2776100
 O'ring 61,5 x 3,55mm



JAE-596-16 - 12992396
 849533/71744380
 Junta Escape
 Junta Escapamento



2775900
 Guarnición goma
 Guarnição borracha



2776400
 Capuchón Bujía
 Vedadores de vela



RT-9205Pol
 Retén Árbol de Levas
 Retentor do Eixo Comando
 de Válvulas
 Lx-R 35,00 x 48,00 x 7,00

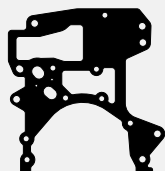

1137600 - 24405911/71739783/5638611
 Distribución
 Distribuição

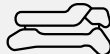

2775500
 Guarnición filtro aceite
 Guarnição filtro óleo



2775600
 Guarnición filtro aceite
 Guarnição filtro óleo



2776200
 O'ring 24,3 x 3,1mm



2776600
 O'ring 13,1 x 2,62mm



2776300
 O'ring 22,4 x 3,1mm



2776000
 Bomba de agua
 Bomba de água



2775700
 Guarnición filtro aceite
 Guarnição filtro óleo



RT-9912Vit
 Retén Distribución
 Ret. Dianteiro do Virabrequim
 Lx-R 32,00 x 42,00 x 8,00

Productos relacionados no incluidos en el juego. Los mismos pueden ser solicitados por separado.

Produtos relacionados não incluídos no jogo. Podem ser solicitados em separado.

Related products that were not included in the set but can be ordered separately.



BU-002
 Bulones para
 Culata de cilindro
 Parafusos de Cabeçote

Juego Completo de Reparación:

Jogo de Juntas do Motor / Full Set Gasket:

JR-374-15**Semi-Juego de Reparación:**

Semi-Jogo de Juntas / Semi-Set Gasket:

SJ-374**Juego de Descarbonización:**

Jogo de Juntas Superior / Head Set Gasket:

JD-374-15

JUNTA CULATA DE CILINDROS	TC-125-15	Ø 80.50mm	1.50mm	±0.05
Junta de cabeçote	TC-125-18 <td>Ø 80.50mm <td>2.30mm <td>±0.05</td> </td></td>	Ø 80.50mm <td>2.30mm <td>±0.05</td> </td>	2.30mm <td>±0.05</td>	±0.05
Cylinder Head gasket				

DESCRIPCIÓN / Descrição / Description

CHEVROLET: Corsa GL MPFI - Kadett E 86/93 - Vectra A 91/97
 Astra 86/93 - Cavalier 86/94 - Ascona C 1986/88 - Chevy
DAEWOO: Cielo - Espero 1994/97 - Lemans - Racer 89/97
 Nexia (93245889)

MOTOR / Engine	CM ³	HP	Ø PISTON
G15MF	1498	75/78	76.50
OHC	1598	75	79.00
E16SE/NE/NZ	1598	75/82/101	79.00
C16LZ/NZ/SV	1598	75/82	79.00

ILLINOIS

CHEV. / DAEWOO

JD-374-15

TC-125-15 - 90352617
 90410093/90541019
 Junta Culata de Cilindros
 Junta Cabeçote



JAE-379-A - 90571862
 90409709/90106615/96183118
 Junta Admisión
 Junta Admissão

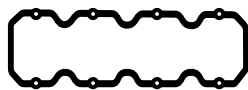

JVS-256-30 - 90354545
 90096964
 Junta Tapa Válvula Superior
 Junta Tampa Válvula Superior



1160400 - 90500068
 Salida de gases 1,6
 Saída de gases



JAE-378-E - 93227660
 90409642
 Junta Escape
 Junta Escapamento



1164700 - 90572062
 Salida de gases 1,4
 Saída de gases



JAE-401-A - 90323399
 Junta Admisión
 Junta Admissão



2706900
 Guarnición termostato
 Guarnição termostato



2706400
 O'ring rectangular
 O'ring retangular
 39 x 47 x 4,3mm



RT-9205Pol
 Retén Árbol de Levas
 Ret. do Eixo Comando de Válv.
 Lx-R 35,00 x 48,00 x 7,00



RT-566Pol
 Jgo. Ret. Guía de Válvulas
 Jogo Retentor da Haste
 de Válvulas

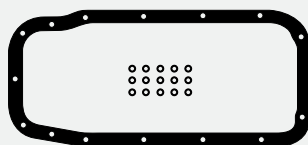

JC-306-30 - 90572656
 90409693/93335433
 Junta Cártér
 c/arandelas limitadoras de apriete
 Junta Carter
 c/arruelas limitadoras de ajuste



1164600 - 90573301/90353564
 Bomba de aceite a block
 Bomba de óleo ao bloco



1164100 - 90412408
 Base TBI
 Base TBI



JSA-232-21
 Salida Escape
 (Anillo malla acero)
 Saída Escapamento
 (Anel malha de aço)



2706800
 O'ring bomba de agua 79,5 x 3mm
 O'ring bomba de água



2707200
 O'ring 40,87 x 3,53mm



2707100
 O'ring 40 x 3mm



2707000 - 94632563
 O'ring 15,64 x 2,62mm



2606900 - N0138492
 Arandela 14 x 20 x 1,5mm
 Arruela (Cobre)



RT-9270Pol
 Retén Bancada
 Retentor Traseiro do Virabrequim
 Lmx-Hel 80,00 x 98,00 x 10,00



RT-9269Pol
 Retén Distribución
 Retentor Dianteiro do Virabrequim
 Mx-R 26,00 x 42,00 x 8,00

Productos relacionados no incluidos en el juego. Los mismos pueden ser solicitados por separado

Produtos relacionados não incluídos no jogo. Podem ser solicitados em separado / Related products that were not included in the set but can be ordered separately.



BU-051
BU-176
BU-052
 Bulones para Culata
 de Cilindros
 Parafusos de Cabeçote



JAE-378-09
JAE-378-11
 Junta Escape
 Junta Escapamento



JSA-217
 Arandela
 Suplemento
 Arruela
 Suplemento



JSA-232-22
 Salida Escape
 Saída Escapamento



JVS-256-23
 Junta Tapa
 Válvula Superior
 Junta Tampa
 Válvula Superior



1005400 (0,4mm)
1005500 (0,6mm)
1005600 (0,8mm)
1005700 (1,0mm)
 Torreta Árbol de Levas
 Junta Gaiola



JC-306-15
JC-306-25
 Junta Cártér
 Junta Carter

DESCRIPCIÓN / Descrição / Description

CHEVROLET: Monza - Kadett 1981/86

MOTOR / Engine	CM ³	HP	Ø PISTON
CN16 - 16SH	1598	90	80.30

Juego Completo de Reparación:

Jogo de Juntas do Motor / Full Set Gasket:

JR-479-15

R

Semi-Juego de Reparación:

Semi-Jogo de Juntas / Semi-Set Gasket:

SJ-479

R

Juego de Descarbonización:

Jogo de Juntas Superior / Head Set Gasket:

JD-479-15

R

JUNTA CULATA DE CILINDROS	TC-491-15	Ø 81.00mm	1.40mm	↑ ↓
Junta de cabeçote		Ø		↑ ↓
Cylinder Head gasket		Ø		↑ ↓

JD-479-15



TC-491-15 - 90122958
Junta Culata de Cilindros
Junta Cabeçote



JSA-250 - 90128293
854933/94649659
Salida Escape
Saída Escapamento



2714300
O'ring 47,22 x 3,53mm



JAE-458-E - 90106615/8920605150
Junta Escape
Junta Escapamento



JAE-492-A - 90106610
Junta Admisión
Junta Admissão



2706100 - 90118437
O'ring 50 x 4,2mm
Carcasa termostato
Carcaça termostato



JVS-292-30 - 90106506
90220309/90412303
Junta Tapa Válvula Superior
Junta Tampa Válvula Superior



1013000 - 94624122
Base carburador
Base carburador



RT-566PoI
Juego Retenes Guía de Válv.
Jogo Retenedor da Haste de Válvulas



JC-328-30 - 90106425
Junta Cáter
Junta Carter



1013200 - 90106432/90106615
Block a filtro
Bloco ao filtro



RT-9205PoI
Retén Árbol de Levas
Retenedor do Eixo Comando de Válvulas
Lx-R 35,00 x 48,00 x 7,00



1193300 - 8930353
90265732/90275602/9275602
Bomba de nafta
Bomba de gasolina



1012900 - 90231306/90122258
Tubo separador bomba de aceite
Tubo separador bomba de óleo



2713500 - 90128513
O'ring 64 x 3mm



2707000 - 94632563
O'ring 15,64 x 2,62mm



2605600 - 1169011
Arandela 14 x 20 x 2mm
Arruela (Aluminio)



2608200 - 105462
Arandela 20 x 24 x 1,5mm
Arruela (Aluminio)



RT-9211Vit
Retén Bancada
Retenedor Dianteiro do Virabrequim
Mx-R-AH 90 x 104,00 x 11,00



RT-8717PoI
Retén Distribución
Retenedor Traseiro do Virabrequim
Lx-R 31,00 x 50,00 x 8,00



2719700 - 90106456
O'ring 90 x 3
Bomba de agua
Bomba de água

Productos relacionados no incluidos en el juego. Los mismos pueden ser solicitados por separado.

Produtos relacionados não incluídos no jogo. Podem ser solicitados em separado.

Related products that were not included in the set but can be ordered separately.



JSA-250-11
Salida Escape (Láminas)
Saída Escapamento (Camadas)

Juego Completo de Reparación:

Jogo de Juntas do Motor / Full Set Gasket:

JR-123-15**R****Semi-Juego de Reparación:**

Semi-Jogo de Juntas / Semi-Set Gasket:

SJ-125**R****Juego de Descarbonización:**

Jogo de Juntas Superior / Head Set Gasket:

JD-131-15**R**

JUNTA CULATA DE CILINDROS	TC-160-15	Ø 80.50mm	1.50mm	↑ ↓	↑ ↓	↑ ↓	↑ ↓
Junta de cabeçote				↑ ↓	↑ ↓	↑ ↓	↑ ↓
Cylinder Head gasket				↑ ↓	↑ ↓	↑ ↓	↑ ↓

DESCRIPCIÓN / Descrição / Description

CHEVROLET: Corsa - Astra - Zafira

Vectra 1993/... - Chevy

OPEL: Tigra

MOTOR / Engine	CM ³	HP	Ø PISTON
C16XE/XEL 16V	1598	109	79.00
X16XEL 16V	1598	100/109	79.00
Y16XE 16V	1598	100/109	79.00

ILLINOIS

CHEVROLET

**JD-131-15**

TC-160-15 - 9106305/90511490
Junta Culata de Cilindros
Junta Cabeçote



JAE-453-A - 850668
90502462/24407475
Junta Admisión
Junta Admissão

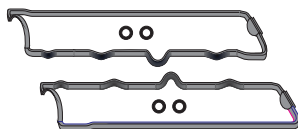

JVS-274-43 - 638736/37
90501525
Junta Tapa Válvula Superior c/arrandelas
Junta Tampa Válvula Superior c/arruelas



2706400
O'ring rectangular
O'ring retangular
39 x 47 x 4,3mm



2701900 - 3910824
O'ring 9,25 x 1,78mm



JAE-452-E - 5850613/90470036
Junta Escape
Junta Escapamento



1193900 - 5850612/90470434
Entre múltiple colector
Entre coletor



2706300
O'ring 60 x 1,78mm
Guarnición termostato
Guarnição termostato



1193800 - 5050611
Entre múltiple colector
Entre coletor



1194000 - 90500068
Salida de gases
Saída de gases

R

RT-9205Pol
Retén Árbol de Levas
Retenedor do Eixo Comando
de Válvulas
Lx-R 35,00 x 48,00 x 7,00



RT-581Pol
Jgo. Ret Guía de Válvulas
Jogo Retenedor da Haste
de Válvulas

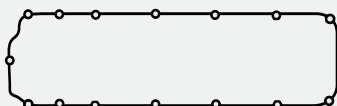

JC-335-43 - 652669/90412846
Junta Cártier
Junta Carter



2605800
Arandela 17 x 21 x 0,5mm
Arruela (Cobre)



1194100 - 90353564
Frente distribución
Frente distribuição



2707000
Bomba de aceite
Bomba de óleo
O'ring 15,64 x 2,62mm



2706200
O'ring 94 x 3mm



2706100 - 90118437
O'ring 50 x 4,2mm



RT-9270Pol - 93309906
Retén Bancada
Retenedor Traseiro do Virabrequim
Lmx-Hel 80,00 x 98,00 x 10,00



RT-9269Pol - 90501719
Retén Distribución
Ret. Dianteiro do Virabrequim
Mx-R 26,00 x 42,00 x 8,00

Productos relacionados no incluidos en el juego. Los mismos pueden ser solicitados por separado.

Produtos relacionados não incluídos no jogo. Podem ser solicitados em separado.

Related products that were not included in the set but can be ordered separately.



BU-002
Bulones para
Tapa de Cilindros
Parafusos de Cabeçote



JV-187
Juego Caja Velocidad
Jogo Caixa de Câmbio

DESCRIPCIÓN / Descrição / Description

CHEVROLET: Pick Up - Corsa - Vectra - Astra Kadett 1992/... - Chevy

MOTOR / Engine	CM ³	HP	Ø PISTON
C16SE 8V	1598	100	79.00
X16SZR 8V	1598	75	79.00

Juego Completo de Reparación:

Jogo de Juntas do Motor / Full Set Gasket:

JR-333-15

R

Semi-Juego de Reparación:

Semi-Jogo de Juntas / Semi-Set Gasket:

SJ-333

R

Juego de Descarbonización:

Jogo de Juntas Superior / Head Set Gasket:

JD-333-15

R

JUNTA CULATA DE CILINDROS	TC-125-15	Ø 80.50mm	1.50mm	1.50mm	1.50mm
Junta de cabeçote	TC-125-18	Ø 80.50mm	2.30mm	2.30mm	2.30mm
Cylinder Head gasket					



JD-333-15



TC-125 - 90352617
90410093/90541019
Junta Culata de Cilindros
Junta Cabeçote



1181000 - 90128293
Soporte inyección
Suporte injeção



1164700 - 90572062
Salida de gases
Saída de gases



JAE-379-A - 90571862
90409709/90106615/96183118
Junta Admisión
Junta Admissão



JAE-378-E - 93227660/90409642
Junta Escape
Junta Escapamento



JAE-401-A - 90323399
Junta Admisión
Junta Admissão

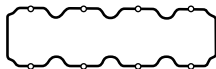

JVS-311-43
638260/7083232/90409594
Junta Tapa Válvula Superior
Junta Tampa Válvula Superior



RT-9205Pol
Retén Árbol de Levas
Retentor do Eixo Comando de Válvulas
Lx-R 35,00 x 48,00 x 7,00



RT-566Pol
Juego Retenes Guía de Válvulas
Jogo Retentor haste de Válvulas

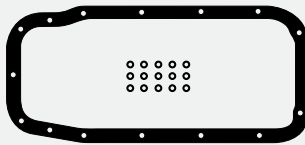

JC-306-30 - 90572656
90409693/93335433
Junta Cártér
c/arandelas limitadoras de apriete
Junta Carter
c/arruelas limitadoras de ajuste



1164600 - 90573301/90353564
Bomba de aceite a block
Bomba de óleo ao bloco



2706800
O'ring bomba de agua
O'ring bomba de água
79,5 x 3mm



2713400
O'ring 9,2 x 2,62mm



2713600
Arandela 38 x 60 x 3mm
Arruela (Sintético)



RT-9270Pol - 93309906
Retén Bancada
Retentor Traseiro do Virabrequim
Lmx-Hel 80,00 x 98,00 x 10,00



RT-9269Pol - 90501719
Retén Distribución
Ret. Dianteiro do Virabrequim
Mx-R 26,00 x 42,00 x 8,00

Productos relacionados no incluidos en el juego. Los mismos pueden ser solicitados por separado
Produtos relacionados não incluídos no jogo. Podem ser solicitados em separado / Related products that were not included in the set but can be ordered separately.



BU-051
BU-052
BU-176
Bulones para Culata de Cilindros
Parafusos de Cabeçote



JC-306-15
JC-306-25
Junta Cártér
Junta Carter



JAE-378-09
JAE-378-11
Junta Escape
Junta Escapamento



JV-187
Juego Caja Velocidad
Jogo Caixa de Câmbio



1005400 (0,4mm)
1005500 (0,6mm)
1005600 (0,8mm)
1005700 (1,0mm)
Torreta A. de Levas
Junta Gaiola

Juego Completo de Reparación:

Jogo de Juntas do Motor / Full Set Gasket:

JR-692-11

DESCRIPCIÓN / Descrição / Description

CHEVROLET: Sonic - Montana 2011/14**Semi-Juego de Reparación:**

Semi-Jogo de Juntas / Semi-Set Gasket:

Juego de Descarbonización:

Jogo de Juntas Superior / Head Set Gasket:

JUNTA CULATA DE CILINDROS	TC-957-15	∅ 82.00mm	1.50mm	∅
Junta de cabeçote	TC-957-MG	∅ 82.00mm	1.50mm	∅
Cylinder Head gasket				∅

MOTOR / Engine	CM ³	HP	∅ PISTON
Z16-LER/LET 16V	1598	180/192	80.00

ILLINOIS

CHEVROLET

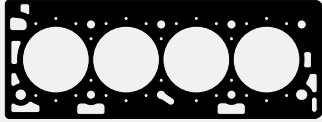
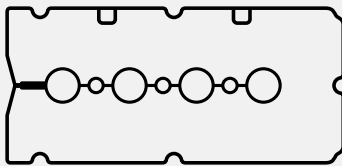
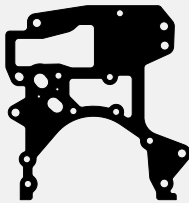
**TC-957** - 93186222/55355578
Junta Culata de Cilindros
Junta Cabeçote**2776800**
Guarnición filtro aceite
Guarnição filtro óleo**2776900**
Guarnición goma
Guarnição borracha**JVS-403-43** - 55354237
Junta Tapa Válvula Superior
Junta Tampa Válvula Superior**JAE-625-E** - 5849914
Junta Escape
Junta Escapamento**JAE-624-A** - 5850534
Junta Admisión
Junta Admissão**1137600** - 24405911/71739783/5638611
Distribución
Distribuição**2775900**
Guarnición goma
Guarnição borracha**2775800**
Guarnición termostato
Guarnição termostato**2775700**
Guarnición filtro aceite
Guarnição filtro óleo**2775600**
Guarnición filtro aceite
Guarnição filtro óleo**2776000**
Bomba de agua
Bomba de água**2776100**
O'ring 61,5 x 3,55mm**R**
Juego Retenes Guía de Válvulas
Jogo Retentor da Haste de Válvulas**Retén Bancada**
Retentor Traseiro do Virabrequim**Retén Árbol de Leva**
Retentor do Eixo Comando
de Válvulas**Retén Distribución**
Retentor Dianteiro do
Virabrequim

Productos relacionados no incluidos en el juego. Los mismos pueden ser solicitados por separado.

Produtos relacionados não incluídos no jogo. Podem ser solicitados em separado.

Related products that were not included in the set but can be ordered separately.

DESCRIPCIÓN / Descrição / Description

CHEVROLET: Astra J

MOTOR / Engine	CM ³	HP	Ø PISTON
A16-LET	1598	180	79.00
Z16-LEL/XNT	1598	150	79.00

Juego Completo de Reparación:

Jogo de Juntas do Motor / Full Set Gasket:

JR-651-11

R

Semi-Juego de Reparación:

Semi-Jogo de Juntas / Semi-Set Gasket:

Juego de Descarbonización:

Jogo de Juntas Superior / Head Set Gasket:

JUNTA CULATA DE CILINDROS	TC-957-15	Ø 82.00mm	1.50mm	↑ ↓
Junta de cabeçote	TC-957-MG	Ø 82.00mm	1.50mm	↑ ↓
Cylinder Head gasket				↑ ↓

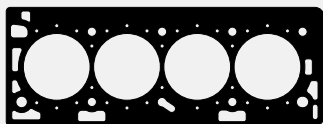

TC-957 - 93186222/55355578
Junta Culata de Cilindros
Junta Cabeçote



1402900
Junta



JSA-306 - 73502844/09202367
Junta Salida de Escape
Junta Saída de Escapamento



JAE-626-E - 24405959/849199
Junta Escape
Junta Escapamento



JAE-608-A - 55568787/850948
Junta Admisión
Junta Admissão



1403000
Junta

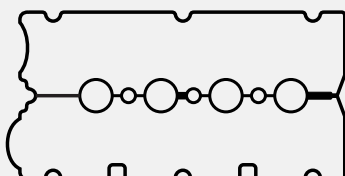

JVS-411-43 - 24440093/5607593
Junta Tapa Válvula Superior
Junta Tampa Válvula Superior

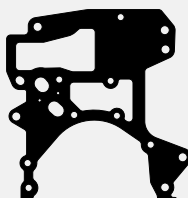

1137600 - 24405911/71739783/5638611
Distribución
Distribuição



Juego Retenes Guía de Válvulas
Jogo Retentor da Haste de Válvulas



Retén Bancada
Retentor Traseiro do Virabrequim



Retén Árbol de Leva
Retentor do Eixo Comando de Válvulas



Retén Distribución
Retentor Dianteiro do Virabrequim

Productos relacionados no incluidos en el juego. Los mismos pueden ser solicitados por separado.

Produtos relacionados não incluídos no jogo. Podem ser solicitados em separado.

Related products that were not included in the set but can be ordered separately.

Juego Completo de Reparación:

Jogo de Juntas do Motor / Full Set Gasket:

Semi-Juego de Reparación:

Semi-Jogo de Juntas / Semi-Set Gasket:

Juego de Descarbonización:

Jogo de Juntas Superior / Head Set Gasket:

SJ-502**R****JD-502-ST****R**

JUNTA CULATA DE CILINDROS	TC-905 0M	Ø80.00mm	1.40mm	de 0,63 a 0,70mm
Junta de cabeçote	TC-905 1M	Ø80.00mm	1.50mm	de 0,71 a 0,76mm
Cylinder Head gasket	TC-905 2M	Ø80.00mm	1.60mm	de 0,77 a 0,83mm
	TC-905 3M	Ø80.00mm	1.70mm	
	TC-905 4M	Ø80.00mm	1.80mm	
	TC-905 5M	Ø80.00mm	2.10mm	

DESCRIPCIÓN / Descrição / Description

DIESEL**CHEVROLET:** Corsa - Astra G DTI - Corsa C DI Combo Tour 16V TD 2000/... - Meriva 1998/... Zafira

MOTOR / Engine	CM ³	HP	Ø PISTON
Y17DIT/DTL (DOHC)16V	1686	65/75	79.00

ILLINOIS

CHEVROLET

MENÚ

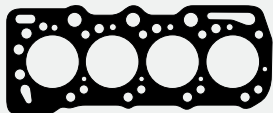
JD-502-ST

TC-905-20 0M TC-905-MG 0M - 97102350SM
 TC-905-20 1M TC-905-MG 1M - 971023501M
 TC-905-20 2M TC-905-MG 2M - 971023502M
 TC-905-20 3M TC-905-MG 3M - 971023503M
 TC-905-20 4M TC-905-MG 4M - 971023504M
 TC-905-20 5M TC-905-MG 5M - 971023505M
 Junta Culata de Cilindros
 Junta Cabeçote

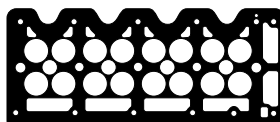

1135500 - 97183468
 Caja porta árbol levas a tapa cilindros
 Caixa porta árvore de comando ao cabeçote



1138600
 Junta



JAE-528-A - 97218652
 Junta Admisión
 Junta Admissão



JAE-529-E - 97219444
 Junta Escape
 Junta Escapamento



1138700 - 97185863
 Cierre gases tapa válvula
 Fechamento gases tampa válvula



JVS-338-43 - 97183007
 Junta Tapa Válvula Superior
 Junta Tampa Válvula Superior



1139100 - 97218651
 Entre colectores admisión
 Entre coletores admissão



2741000
 O'ring 65 x 2,5mm
 Guarnición goma termostato
 Guarnição borracha termostato



1139400 - 94457048
 Tapa termostato
 Tampa termostato



1139500 - 94362672
 Retorno aceite turbo
 Retorno óleo turbo



2749900
 O'ring 37,5 x 3mm



2751100
 O'ring 14 x 2mm



2630200
 Arandela 20 x 28 x 1mm
 Arruela (Cobre)



1139200
 Junta



RT-9640Vit
 Retén Árbol de Levas
 Retenedor do Eixo Comando de Válvulas
 A 156-R 38,00 x 50,00 x 8,00



RT-581Pol
 Jgo. Ret. Guía de Válvulas
 Jogo Retenedor da Haste de Válvulas



RT-8530Vit
 Retén Bancada
 Retenedor Traseiro do Virabrequim
 A 156-R-A 87,00 x 100,00 x 8,00



JC-363-15
 Junta Cártel Superior
 Junta Carter Superior

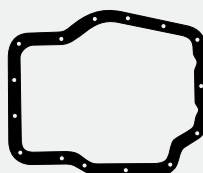

JC-367-34
 Junta Cártel Inferior
 Junta Carter Inferior

Productos relacionados no incluidos en el juego. Los mismos pueden ser solicitados por separado.

Produtos relacionados não incluídos no jogo. Podem ser solicitados em separado.

Related products that were not included in the set but can be ordered separately.



BU-001
 Bulones para Culata de Cilindros
 Parafusos de Cabeçote

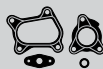

JT-128
 Juego Turbo
 Jogo Turbo



1005100
 Caja porta Ár. Levas a Tapa Cilindros
 Caixa porta Árvore a Comando Cabeçote (Reforma)

DESCRIPCIÓN / Descrição / Description **DIESEL**

CHEVROLET: Corsa D - Combo D 1997/...
Vectra TD 1991/96 - Astra TD 1994/97
Cavalier TD (97721730)
MAZDA: 323 TD

MOTOR / Engine	CM ³	HP	Ø PISTON
4EE1	1686	60	79.00
4EE1T	1686	82	79.00
X17 D-T	1686	60/82	79.00

Juego Completo de Reparación:

Jogo de Juntas do Motor / Full Set Gasket:

Semi-Juego de Reparación:

Semi-Jogo de Juntas / Semi-Set Gasket:

SJ-274

R

Juego de Descarbonización:

Jogo de Juntas Superior / Head Set Gasket:

JD-274-ST

R

JUNTA CULATA DE CILINDROS
Junta de cabeçote
Cylinder Head gasket

		Ø	mm	mm	mm	mm
TC-512 0M	Ø 80.50mm	1.40mm	de 0,58 a 0,64mm			
TC-512 1M	Ø 80.50mm	1.50mm	de 0,65 a 0,71mm			
TC-512 2M	Ø 80.50mm	1.60mm	de 0,72 a 0,78mm			
TC-512 3M	Ø 80.50mm	1.70mm				
TC-512 4M	Ø 80.50mm	1.80mm				
TC-512 5M	Ø 80.50mm	2.10mm				
TC-512 6M	Ø 80.50mm	2.40mm				

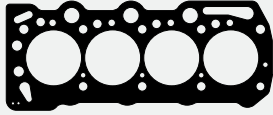

- TC-512-20 0M TC-512-MG 0M - 608805/97044730
- TC-512-20 1M TC-512-MG 1M - 97044731
- TC-512-20 2M TC-512-MG 2M - 97370797/97044732
- TC-512-20 3M TC-512-MG 3M - 97044733
- TC-512-20 4M TC-512-MG 4M
- TC-512-20 5M TC-512-MG 5M
- TC-512-20 6M TC-512-MG 6M

Junta Culata de Cilindros
Junta Cabeçote

JD-274-ST



1184500
Junta câmara de agua
Junta câmara água



1184600
Junta termostato
Junta termostato



1184800
Inspección TC
Inspeção cabeçote



JAE-411-E - 850602
Junta Escape
Junta Escapamento



1184900
Retorno agua
Retorno água



1184700
Junta filtro de aire
Junta filtro ar



JAE-410-A - 850603/97112677
Junta Admisión
Junta Admissão



JVS-275-43 - 603631/94313803
Junta Tapa Válvula Superior
Junta Tampa Válvula Superior



2741200
Media luna árbol de levas
Meia lua árvore de comando



2741600
Media luna cierre
Meia lua fechamento



RT-8606Vit
8944686541
Retén Árbol de Levas
Ret. do Eixo Comando de Válv.
Lx-Hel 40,00 x 52,00 x 7,00



RT-2989Pol
Juego Retenes
Guía de Válvulas
Jogo Retentor da
Haste de Válvulas



JC-313-26 - 652596
Junta Carter
Junta Carter



1184300
Junta bomba de agua N°1
Junta bomba de água N°1



1184400
Junta bomba de agua N°2
Junta bomba de água N°2



2741300
O'ring rectangular
O'ring retangular
57 x 67 x 6mm
(Silicona/e)



2741700
Tubo 17 x 24 x 9mm

2631700 - Juego Arandelas Metálicas/ Jogo Arruelas Metálica

Gráfico	Descripción/Descrição	Cant./Quant.
○	Arand./Arruela 14x20x1,5mm Cobre	1
○	Arand./Arruela 12x17x2mm Cobre	1
○	Arand./Arruela 8x14x1mm Cobre	2

2727300 - Juego Arandelas de Goma/ Jogo Arruelas de Borracha

Gráfico	Descripción/Descrição	Cant./Quant.
○	O'ring 64x2,5mm	1
○	O'ring 23x2mm	1
○	O'ring 17x2,6mm	1
○	O'ring 17x2,2mm	1
○	O'ring 10,8x2,3mm	1



RT-8530Vit - 94327063
Retén Bancada
Retentor Traseiro do Virabrequim
A 156-R 87,00 x 100,00 x 8,00



RT-8606Vit - 8944686541
Retén Distribución
Retentor Dianteiro do Virabrequim
Lx-Hel 40,00 x 52,00 x 7,00



RT-9852Pol
Retén Bomba de Aceite
Retentor Bomba de Óleo
Lx-R 18,00 x 32,00 x 6,00

Productos relacionados no incluidos en el juego. Los mismos pueden ser solicitados por separado.

Produtos relacionados não incluídos no jogo. Podem ser solicitados em separado.

Related products that were not included in the set but can be ordered separately.



BU-001
Bulones para
Culata de Cilindros
Parafusos de Cabeçote

Juego Completo de Reparación:

Jogo de Juntas do Motor / Full Set Gasket:

JR-553**Semi-Juego de Reparación:**

Semi-Jogo de Juntas / Semi-Set Gasket:

SJ-553**Juego de Descarbonización:**

Jogo de Juntas Superior / Head Set Gasket:

JD-553

JUNTA CULATA DE CILINDROS Junta de cabeçote Cylinder Head gasket	TC-552-15	∅ 81.50mm	1.60mm	↑ ↓
	TC-552-MG	∅ 81.50mm	1.60mm	↑ ↓
				↑ ↓
				↑ ↓

DESCRIPCIÓN / Descrição / Description

CHEVROLET: Corsa II - Meriva 2003/...

Optra - Design

FIAT: Palio Fase II 2004/...

MOTOR / Engine	CM ³	HP	∅ PISTON
L79 - ALX (DOHC) 16V	1781	122	80.50

ILLINOIS

CHEVROLET

**JD-553**

TC-552 - 93294584
Junta Culata de Cilindros
Junta Cabeçote



JSA-250 - 90128293
854933/94649659
Salida Escape
Saída Escapamento



1177300 - 129799/94649659
Base carburador Brosol
Base carburador Brosol



JAE-452-E - 5850613/90470036
Junta Escape
Junta Escapamento



JAE-538-A - 90536057
Junta Admisión
Junta Admissão



1003900 - 90566088
Válvula aceleración
Válvula aceleração



JVS-346-43 - 7083391
Junta Tapa Válvula Superior
c/arandelas
Junta Tampa Válvula Superior
c/arruelas



2706300 - 09157005
O'ring 60 x 1,78mm
Guarnición termostato
Guarnição termostato



RT-581Pol
Jgo. Ret. Guía de Válvulas
Jogo Retentor da Haste
de Válvulas



RT-9205Pol
Retén Árbol de Levas
Ret. do Eixo Comando de Válv.
Lx-R 35,00 x 48,00 x 7,00

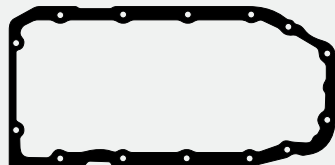

JC-357-26 - 652635/90467759
Junta Cártier Superior
Junta Carter Superior



1164600 - 90573301/90353564
Bomba de aceite a block
Bomba de óleo ao bloco



2738100 - 90220436
O'ring 52,20 x 2,62mm



2606900 - N0138492
Arandela 14 x 20 x 1,5mm
Arruela (Cobre)



2706800 - 09152179
O'ring 79,5 x 3mm



RT-9270Pol
Retén Bancada
Retentor Traseiro do Virabrequim
Lmx-Hel 80,00 x 98,00 x 10,00



RT-6690Pol
Retén Distribución
Retentor Dianteiro do Virabrequim
Lz-R 30,00 x 42,00 x 7,00



Productos relacionados no incluidos en el juego. Los mismos pueden ser solicitados por separado.

Produtos relacionados não incluídos no jogo. Podem ser solicitados em separado.

Related products that were not included in the set but can be ordered separately.



BU-002
Bulones para
Culata de Cilindros
Parafusos de Cabeçote



JSA-250-11
Salida Escape (Láminas)
Saída Escapamento (Camadas)

DESCRIPCIÓN / Descrição / Description

CHEVROLET: Monza SLE/SEE - Kadett
Rekord 1983/...

MOTOR / Engine	CM ³	HP	Ø PISTON
C18N S/E	1796	75/90	84.80

Juego Completo de Reparación:

Jogo de Juntas do Motor / Full Set Gasket:

JR-480-15

R

Semi-Juego de Reparación:

Semi-Jogo de Juntas / Semi-Set Gasket:

SJ-480

R

Juego de Descarbonización:

Jogo de Juntas Superior / Head Set Gasket:

JD-480-15

R

JUNTA CULATA DE CILINDROS	TC-612-15	Ø 87.40mm	1.50mm	↕
Junta de cabeçote				↕
Cylinder Head gasket				↕

JD-480-15



TC-612-15 - 90122951
94658175/52272664/92060517
Junta Culata de Cilindros
Junta Cabeçote



JSA-250 - 90128293
854933/94649659
Salida Escape
Saída Escapamento



1177300 - 129799/94649659
Base Carburador
Base Carburador



2706100 - 90118437
O'ring 50 x 4,2mm
Carcasa termostato
Carcaça termostato



JAE-456-A - 90215011
Junta Admisión
Junta Admissão



JAE-457-A - 90215011
Junta Admisión (Inyección)
Junta Admissão (Injeção)



JAE-458-E - 90106615/8920605150
Junta Escape
Junta Escapamento



JAE-492-A - 90106610
Junta Admisión
Junta Admissão



JVS-292-30 - 90106506
90220309/90412303
Junta Tapa Válvula Superior
Junta Tampa Válvula Superior



1012800 - 90183165
Válvula termostato
Válvula termostato



RT-9205Pol
Retén Árbol de Levas
Ret. do Eixo Comando de Válvulas
Lx-R 35,00 x 48,00 x 7,00



RT-566Pol
Jgo. Ret. Guía de Válvulas
Jogo Retenedor da Haste de Válvulas

R



JC-328-30 - 90106425
Junta Cártel
Junta Carter



1013200 - 90106432/90106615
Block a filtro
Bloco ao filtro



2719700 - 90106456
O'ring 90 x 3
Bomba de agua
Bomba de água



2713500 - 90128513
O'ring 64 x 3mm



1193300 - 8930353
90265732/90275602/9275602
Bomba de nafta
Bomba gasolina



1013000 - 94624122
Base Carburador
Base Carburador



1012900 - 90231306/90122258
Tubo separador bomba de aceite
Tubo separador bomba óleo



1013100 - 90122258/90183165
Junta comando
Junta comando



2707000 - 94632563
O'ring 15,64 x 2,62mm



2605600 - 1169011
Arandela 14 x 20 x 2mm
Arruela (Aluminio)



2608200 - 105462
Arandela 20 x 24 x 1,5mm
Arruela (Aluminio)



2611000
Arandela blindada
14 x 18 x 2,5mm
Arruela blindada (Cobre)



RT-9211Vit
Retén Bancada
Retenedor Traseiro do Virabrequim
Mx-R AH 90,00 x 104,00 x 11,00



RT-8717Pol
Retén Distribución
Ret. Dianteiro do Virabrequim
Lx-R 31,00 x 50,00 x 8,00

R

Productos relacionados no incluidos en el juego. Los mismos pueden ser solicitados por separado.

Produtos relacionados não incluídos no jogo. Podem ser solicitados em separado.

Related products that were not included in the set but can be ordered separately.



BU-063
Bulones para
Culata de Cilindros
Parafusos de Cabeçote



JSA-250-11
Salida Escape (Láminas)
Saída Escapamento
(Camadas)

Juego Completo de Reparación:

Jogo de Juntas do Motor / Full Set Gasket:

JR-319**R****Semi-Juego de Reparación:**

Semi-Jogo de Juntas / Semi-Set Gasket:

SJ-319**R****Juego de Descarbonización:**

Jogo de Juntas Superior / Head Set Gasket:

JD-319**R**

JUNTA CULATA DE CILINDROS	TC-165-15	Ø 82.00mm	1.50mm	1.50mm
Junta de cabeçote	TC-165-MG	Ø 82.00mm	1.50mm	1.50mm
Cylinder Head gasket				

DESCRIPCIÓN / Descrição / Description

CHEVROLET: Corsa - Meriva 2003 - Chevy
FIAT: Stilo - Strada Working - Adventure
 Palio 2003

MOTOR / Engine	CM ³	HP	Ø PISTON
GM Powertrain	1796	102	80.50
OHC 171/190			
MPFI 8V			

ILLINOIS

CHEVROLET

JD-319

TC-165 - 93294583
 Junta Culata de Cilindros
 Junta Cabeçote



JSA-250 - 90128293
 854933/94649659
 Salida Escape
 Saída Escapamento



2756700
 Guarnición acople admisión G3
 Guarnição acoplamento admissão



JAE-379-A - 90571862/63
 90409709/90106615/96183118
 Junta Admisión
 Junta Admissão



JAE-368-A - 7084980
 Juego Admisión
 Jogo Admissão



2756500 - 7084981
 Junta cuerpo mariposa aceleración G3
 Junta corpo borboleta aceleração



JAE-378-E - 93227660/90409642
 Junta Escape
 Junta Escapamento



1181000 - 90128293
 Soporte inyección
 Suporte injeção



2710200 - 71716584/7086225
 Sensor temperatura de agua (Admisión)
 Sensor de temperatura de água (Admissão)

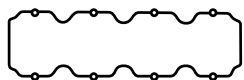

JVS-311-43
 638260/7083232/90409594
 Junta Tapa Válvula Superior
 Junta Tampa Válvula Superior



RT-9205Pol
 Retén Árbol de Levas
 Ret. do Eixo Comando de Válv.
 Lx-R 35,00 x 48,00 x 7,00



RT-566Pol
 Jgo. Ret. Guía de Válvulas
 Jogo Retentor da Haste de Válvulas

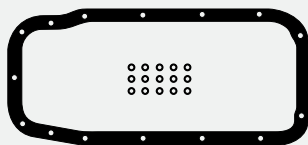

JC-306-30 - 90572656
 90409693/93335433
 Junta Cártel
 c/arandelas limitadoras de apriete
 Junta Carter
 c/arruedas limitadoras de ajuste



1164600 - 90573301
 90353564
 Bomba de aceite a block
 Bomba de óleo ao bloco



2706800
 Bomba de agua
 Bomba de água
 O'ring 79,5 x 3mm



2713400
 O'ring 9,2 x 2,62mm



RT-9270Pol - 93309906
 Retén Bancada
 Retentor Traseiro do Virabrequim
 Lmx-Hel 80,00 x 98,00 x 10,00



RT-9269Pol - 90501719
 Retén Distribución
 Retentor Dianteiro do Virabrequim
 Mx-R 26,00 x 42,00 x 8,00

Productos relacionados no incluidos en el juego. Los mismos pueden ser solicitados por separado

Produtos relacionados não incluídos no jogo. Podem ser solicitados em separado / Related products that were not included in the set but can be ordered separately.



BU-052
 Bulones para
 Culata de Cilindros
 Parafusos de Cabeçote



JC-306-15
JC-306-25
 Junta Cártel
 Junta Carter



JSA-306
 Salida Escape
 Saída Escapamento



JSA-250-11
 Salida Escape (Láminas)
 Saída Escapamento
 (Camadas)



JAE-378-09
JAE-378-11
 Junta Escape
 Junta Escapamento



1005400 (0,4mm)
1005500 (0,6mm)
1005600 (0,8mm)
1005700 (1,0mm)
 Torreta Árbol de Levas
 Junta Gaiola

DESCRIPCIÓN / Descrição / Description			
CHEVROLET: Spin - Cobalt			
MOTOR / Engine	CM ³	HP	Ø PISTON
N18XFN	1796	108	80.50

Juego Completo de Reparación: Jogo de Juntas do Motor / Full Set Gasket:	JR-558	R		
Semi-Juego de Reparación: Semi-Jogo de Juntas / Semi-Set Gasket:	SJ-558	R		
Juego de Descarbonización: Jogo de Juntas Superior / Head Set Gasket:	JD-558	R		
JUNTA CULATA DE CILINDROS	TC-165-15	Ø 82.00mm	1.40mm	±0.05
	TC-165-MG	Ø 82.00mm	1.40mm	±0.05
Junta de cabeçote				
Cylinder Head gasket				



JD-558



TC-165 - 93294583
Junta Culata de Cilindros
Junta Cabeçote



JAE-368-A - 7084980
Juego Admisión
Jogo Admissão



JSA-321 - 94733773
Salida Escape
Saída Escapamento

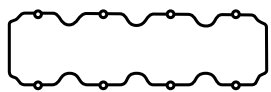

JVS-311-43
Junta Tapa Válvula Superior
Junta Tampa Válvula Superior



JAE-378-E - 93227660/90409642
Junta Escape
Junta Escapamento

RT-594Pol
Juego Retenes Guía de Válvulas
Jogo Retentor da Haste de Válvulas

RT-9205Pol
Retén Árbol de Levas
Ret. do Eixo Comando de Válvulas
Lx-R 35,00 x 48,00 x 7,00



2728800
O'ring 64,77 x 2,62mm



2707000
O'ring 15,64 x 2,62mm
Salida depresor
Saída depressor



1164600 - 90573301/90353564
Bomba de aceite a block
Bomba de óleo ao bloco



JSA-306 - 73502844/09202367
Salida Escape
Saída Escapamento



1164700 - 90572062
Salida de gases
Saída de gases



2706800
Bomba de agua
Bomba de água
O'ring 79,5 x 3mm



RT-9270Pol - 93309906
Retén Bancada
Retentor Traseiro do Virabrequim
Lmx-Hel 80,00 x 98,00 x 10,00



RT-9269Pol - 90501719
Retén Distribución
Retentor Dianteiro do Virabrequim
Mx-R 26,00 x 42,00 x 8,00

Productos relacionados no incluidos en el juego. Los mismos pueden ser solicitados por separado.
Produtos relacionados não incluídos no jogo. Podem ser solicitados em separado.
Related products that were not included in the set but can be ordered separately.

Juego Completo de Reparación:

Jogo de Juntas do Motor / Full Set Gasket:

JR-380-15**Semi-Juego de Reparación:**

Semi-Jogo de Juntas / Semi-Set Gasket:

SJ-380**Juego de Descarbonización:**

Jogo de Juntas Superior / Head Set Gasket:

JD-380-15

JUNTA CULATA DE CILINDROS	TC-612-15	Ø 87.40mm	1.50mm	±0.05
Junta de cabeçote				
Cylinder Head gasket				

DESCRIPCIÓN / Descrição / Description

CHEVROLET: Monza 1996/... - Ascona C 1986/1988 - Kadett 1986/91 - Astra 1991/... - Vectra 1988/95
DAEWOO: Espero - Lemans - Racer - Prince - Aranos Leganza - Compact - Nubira II - Magnus 1989/... (52272664/92060517)

MOTOR / Engine	CM ³	HP	Ø PISTON
C18NE - E18SE (FII)	1796	84/112	84.80
C20NE - C20LE	1998	97/116	86.00

ILLINOIS

CHEV. / DAEWOO

JD-380-15

TC-612-15 - 90122951
94658175/52272664/92060517
Junta Culata de Cilindros
Junta Cabeçote



JSA-250 - 90128293
854933/94649659
Salida Escape
Saída Escapamento



JAE-458-E - 90106615/8920605150
Junta Escape
Junta Escapamento



JAE-456-A - 90215011
Junta Admisión
Junta Admissão



JAE-457-A -
90353579/90499338/850601/
5850608/850500
Junta Admisión (Inyección)
Junta Admissão (Injeção)



1177300 - 129799/94649659
Base carburador
Base carburador



2706100 - 90118437
O'ring 50 x 4,2mm
Carcasa termostato
Carcasa termostato



JVS-292-30 - 90106506
90220309/90412303
Junta Tapa Válvula Superior
Junta Tampa Válvula Superior



1012800 - 90183165
Válvula termostato
Válvula termostato



RT-9205Pol
Retén Árbol de Levas
Ret. do Eixo Comando de Válvulas
Lx-R 35,00 x 48,00 x 7,00



RT-566Pol
Jgo. Ret. Guía de Válvulas
Jogo Retentor da Haste
de Válvulas



JC-339-43 - 90124295/90106425
Junta Cártel
Junta Carter



1013200 - 90106432/90106615
Block a filtro
Bloco ao filtro



2719700 - 90106456
O'ring 90 x 3mm
Bomba de agua
Bomba de água



2713500 - 90128513
O'ring 64 x 3mm



1193300 - 8930353
90265732/90275602/9275602
Bomba de nafta
Bomba de gasolina



1013100 - 90122258/90183165
Junta comando
Junta comando



1013000 - 94624122
Base carburador
Base carburador



1012900 - 90231306/90122258
Tubo separador bomba de aceite
Tubo separador bomba de óleo



2707000 - 94632563
O'ring 15,64 x 2,62mm



2605600 - 1169011
Arandela 14 x 20 x 2mm
Arruela (Aluminio)



2608200 - 105462
Arandela 20 x 24 x 1,5mm
Arruela (Aluminio)



2611000
Arandela blindada
14 x 18 x 2,5mm
Arruela blindada (Cobre)



RT-9211Vit
Retén Bancada
Retentor Traseiro do Virabrequim
Mx-R 90,00 x 104,00 x 11,00



RT-8717Pol
Retén Distribución
Ret. Dianteiro do Virabrequim
Lx-R 31,00 x 50,00 x 8,00

Productos relacionados no incluidos en el juego. Los mismos pueden ser solicitados por separado.

Produtos relacionados não incluídos no jogo. Podem ser solicitados em separado.

Related products that were not included in the set but can be ordered separately.



BU-063
Bulones para
Culata de Cilindros
Parafusos de Cabeçote



JB-260
Juego Carburador
Jogo Carburador



JSA-250-11
Salida Escape (Láminas)
Saída Escapamento
(Camadas)



JC-337-43
Junta Cártel (c/deflector)
Junta Carter (c/defletor)

DESCRIPCIÓN / Descrição / Description

DIESEL

CHEVROLET: Captiva - Cruze

MOTOR / Engine

CM³

HP

Ø PISTON

LLW	1991	125	83.00
Z20DM/DMH	1991	120/125	83.00
Z20S/S1	1991	120/125	83.00

Juego Completo de Reparación:

Jogo de Juntas do Motor / Full Set Gasket:

JR-654-11

R

Semi-Juego de Reparación:

Semi-Jogo de Juntas / Semi-Set Gasket:

Juego de Descarbonización:

Jogo de Juntas Superior / Head Set Gasket:

JUNTA CULATA DE CILINDROS	TC-692-11	Ø 84.00mm	1.10mm	↕
Junta de cabeçote				↕
Cylinder Head gasket				↕

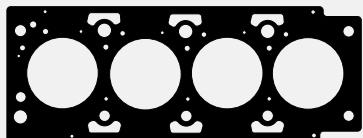

TC-692-11 - 96440163/4804888
Junta Culata de Cilindros
Junta Cabeçote



Bomba de agua
Bomba de água



Junta

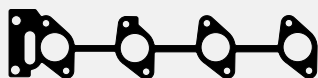

Junta Escape
Junta Escapamento



Junta Admisión
Junta Admissão



Junta



Junta Tapa Válvula Superior
Junta Tampa Válvula Superior



Junta



Junta



Junta



Junta



Junta



Junta



Retén Bancada
Retentor Traseiro
do Virabrequim



Retén Distribución
Retentor Dianteiro
do Virabrequim



Retén Árbol de Levas
Retentor do Eixo Comando
de Válvulas



Juego Retenes Guía de Válvulas
Jogo Retentor da Haste
de Válvulas

R

Productos relacionados no incluidos en el juego. Los mismos pueden ser solicitados por separado.

Produtos relacionados não incluídos no jogo. Podem ser solicitados em separado.

Related products that were not included in the set but can be ordered separately.

Juego Completo de Reparación:

Jogo de Juntas do Motor / Full Set Gasket:

JR-772-07

DESCRIPCIÓN / Descrição / Description

CHEVROLET: Tracker 2006/...**SUZUKI:** Vitara 1998/06 - SX4 2006/...

Grand Vitara 1998/06

MOTOR / Engine	CM ³	HP	Ø PISTON
J20A 16V (DOHC)	1995	120/129	84.00

ILLINOIS.

CHEVROLET**Juego de Descarbonización:**

Jogo de Juntas Superior / Head Set Gasket:

JUNTA CULATA DE CILINDROS	TC-679-07	Ø 85.00mm	1.20mm	↑ ↓
Junta de cabeçote				↑ ↓
Cylinder Head gasket				↑ ↓

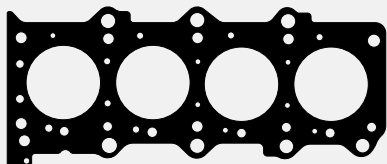

TC-679-07 - 1114121111/1114177E01/02
Junta Culata de Cilindros
Junta Cabeçote



131197EA0
Junta Admisión
Junta Admissão



Junta



1118977
Junta Tapa Válvula Superior
Junta Tampa Válvula Superior



1414065D01/2
Junta Escape
Junta Escapamento



Anillo Goma
Anel Borracha



RT-8628Pol
Retén Árbol de Levas
Retenedor do Eixo Comando de Válvulas
32,00 x 47,00 x 6,00



Junta



Junta



RT-9246Pol
Retén Bancada
Retenedor Traseiro do Virabrequim
Lx-R AH 98,00 x 116,00 x 10,00



RT-9882Vit
Retén Distribución
Retenedor Dianteiro do Virabrequim
Lx-R-H 45,00 x 63,00 x 7,50



Jgo. Ret. Guía de Válvulas
Jogo Retenedor Haste de Válvula



Productos relacionados no incluidos en el juego. Los mismos pueden ser solicitados por separado.

Produtos relacionados não incluídos no jogo. Podem ser solicitados em separado.

Related products that were not included in the set but can be ordered separately.

DESCRIPCIÓN / Descrição / Description

CHEVROLET: Monza 1986/... - Kadett 1989/...
Astra - Ipanema 1989/... (52278189)
OPEL: Omega A 1986/94 - Frontera 1991/95
Calibra - Cavalier

MOTOR / Engine	CM ³	HP	Ø PISTON
C20NE/SEH/SER OHC	1998	115/130	86.00
C20NEF/SEH OHC	1998	100/130	86.00

Juego Completo de Reparación:

Jogo de Juntas do Motor / Full Set Gasket:

JR-481-15

R

Semi-Juego de Reparación:

Semi-Jogo de Juntas / Semi-Set Gasket:

SJ-481

R

Juego de Descarbonización:

Jogo de Juntas Superior / Head Set Gasket:

JD-481-15

R

JUNTA CULATA DE CILINDROS	TC-712-15	Ø 87.40mm	1.50mm	±0.05
Junta de cabeçote	TC-712-18	Ø 87.40mm	2.30mm	±0.05
Cylinder Head gasket				

JD-481-15

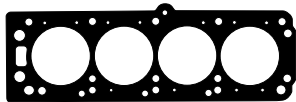

TC-712-15 - 90122951
94658175/52272664/92060517
Junta Culata de Cilindros
Parafusos de Cabeçote



JSA-250 - 90128293
854933/94649659
Salida Escape
Saída Escapamento



1012800 - 90183165
Válvula termostato
Válvula termostato



2706100 - 90118437
O'ring 50 x 4,2mm
Carcasa termostato
Carcça termostato



JAE-456-A - 90215011
Junta Admisión
Junta Admissão



JAE-457-A
Junta Admisión (Inyección)
Junta Admissão (Injeção)



JAE-458-E - 90106615
Junta Escape
Junta Escapamento



JAE-492-A - 90106610
Junta Admisión
Junta Admissão



JVS-292-30 - 90220309/90106506
Junta Tapa Válvula Superior
Junta Tampa Válvula Superior



RT-9205PoI
Retén Árbol de Levas
Ret. do Eixo Comando de Válvulas
Lx-R 35,00 x 48,00 x 7,00



RT-566PoI
Jgo. Ret. Guía de Válvulas
Jogo Retentor da Haste de Válvulas



2719700 - 90106456
O'ring 90 x 3mm
bomba de agua
bomba de água



JC-339-43 - 90124295/90106425
Junta Cártér
Junta Carter



1013200 - 90106432/90106615
Block a filtro
Bloco ao filtro



1013000 - 94624122
Base carburador
Base carburador



1012900 - 90231306/90122258
Tubo separador bomba de aceite
Tubo separador bomba de óleo



1193300 - 8930353
90265732/90275602
Bomba de nafta
Bomba de gasolina



261100
Arandela blindada
Arruela blindada (Cobre)
14 x 18 x 2,5mm



2713500 - 90128513
O'ring 64 x 3mm



2608200 - 105462
Arandela 20 x 24 x 1,5mm
Arruela (Aluminio)



2734900
O'ring 47,3 x 2,62mm



2704100
O'ring 55,25 x 2,62mm



RT-9211Vit
Retén Bancada
Retentor Traseiro do Virabrequim
Mx-R 90,00 x 104,00 x 11,00



RT-8717PoI
Retén Distribución
Ret. Dianteiro do Virabrequim
Lx-R 31,00 x 50,00 x 8,00



2722800
O'ring 16 x 2mm



2707000 - 94632563
O'ring 15,64 x 2,62mm

Productos relacionados no incluidos en el juego. Los mismos pueden ser solicitados por separado.

Produtos relacionados não incluídos no jogo. Podem ser solicitados em separado.

Related products that were not included in the set but can be ordered separately.



BU-063
Bulones para Culata de Cilindros
Parafusos de Cabeçote



JSA-250-11
Salida Escape (Láminas)
Saída Escapamento (Camadas)



JC-337-43
Junta Cártér (c/deflector)
Junta Carter (c/defletor)

Juego Completo de Reparación:

Jogo de Juntas do Motor / Full Set Gasket:

JR-530-15**Semi-Juego de Reparación:**

Semi-Jogo de Juntas / Semi-Set Gasket:

SJ-530**Juego de Descarbonización:**

Jogo de Juntas Superior / Head Set Gasket:

JD-530-15

JUNTA CULATA DE CILINDROS Junta de cabeçote Cylinder Head gasket	TC-712-15	Ø 87.40mm	1.50mm	±0.05
	TC-712-18	Ø 87.40mm	2.30mm	±0.05
				±0.05
				±0.05

DESCRIPCIÓN / Descrição / Description

CHEVROLET: Vectra - Astra 1995/... - Zafira Sintra 1996/99 - Calibra

MOTOR / Engine	CM ³	HP	Ø PISTON
X20XE (DOHC 16V)	1998	136	86.00
X22XE (DOHC 16V)	2198	142	86.00

ILLINOIS

CHEVROLET

JD-530-15

TC-712-15 - 90122951
94658175/52272664/92060517
Junta Culata de Cilindros
Junta Cabeçote



JAE-523-A - 850655
Junta Admisión
Junta Admissão



JAE-419-09 - 850656
Junta Escape
Junta Escapamento

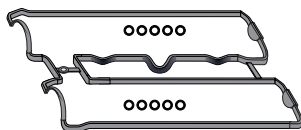

JVS-305-43 - 607647/90501944
Junta Tapa Válvula Superior
Junta Tampa Válvula Superior

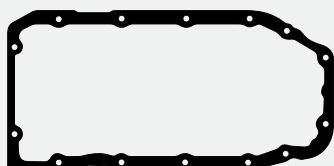

JC-357-26 - 652635/90467759
Junta Carter Superior
Junta Carter Superior

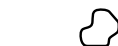

2750100
Guarnición termostato
Guarnição termostato



2750200
Guarnición termostato
Guarnição termostato



1006000
Placa admisión
Placa admissão



JSA-250 - 90128293/85493394649659
Salida Escape
Saída Escapamento



RT-581Pol
Juego Retenes Guía de Válvulas
Jogo Retentor da Haste de Válvulas



RT-9205Pol
Retén Arbol de Levas
Retentor do Eixo Comando de Válvulas
Lx-R-H 35,00 x 48,00 x 7,00



1133800 - 90412686
Junta válvula a aceleración
Junta válvula ao aceleração



1012900 - 90231306
90122258/90183165
Tubo separador bomba de aceite
Tubo separador bomba de óleo



2606900
Arandela 14 x 20 x 1mm
Arruela (Cobre)

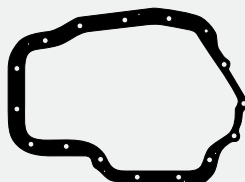

JC-365-26 - 652636
Junta Carter Inferior
Junta Carter Inferior



1013200 - 90106432/90106615
Block a filtro
Bloco ao filtro



2608200
Arandela 20 x 24 x 1,5mm
Arruela (Aluminio)



2719700 - 90106456
O'ring 90 x 3mm
Bomba de agua / Bomba de água

2750400 - Juego Arandelas Goma/ Jogo Arruelas Borracha

Gráfico	Descripción/Descrição	Cant./Quant.
	O'ring 64,77x2,62mm	3
	O'ring 53,7x1,78mm	1
	O'ring 52,07x2,62mm	1
	O'ring 47,22x3,53mm	2
	O'ring 16x2mm	1
	O'ring 15,54x2,62mm	1



RT-8717Pol
Retén Distribución
Retentor Dianteiro do Virabrequim
Lx-R-H 31,00 x 50,00 x 8,00



RT-9211Vit
Retén Bancada
Retentor Traseiro do Virabrequim
Mx-R AH 90,00 x 104,00 x 11,00

Productos relacionados no incluidos en el juego. Los mismos pueden ser solicitados por separado

Produtos relacionados não incluídos no jogo. Podem ser solicitados em separado / Related products that were not included in the set but can be ordered separately.



BU-064
Bulones para
Culata de Cilindros
Parafusos de Cabeçote



JSA-250-11
Salida Escape (Láminas)
Saída Escapamento
(Camadas)



JSA-300-21
Salida Escape
(anillo malla acero)
Saída Escap. (anel malha aço)



JAE-539-09
Junta Escape
Junta Escapamento
(Reforma)



JV-190
Juego Caja Velocidad
Jogo Caixa de Câmbio



JC-357-43
Junta Carter Superior
Junta Carter Superior



JC-365-43
Junta Carter Inferior
Junta Carter Inferior

DESCRIPCIÓN / Descrição / Description

CHEVROLET: Astra 1995/... - Omega B
Calibra 1994/... - Zafira 1998/...
DAEWOO: Leganza 1997/... - Nubira I/II 1997/...
Magnus 2001/...

MOTOR / Engine	CM ³	HP	Ø PISTON
X20XE	1998	136	86.00
X22SED	1998	136/148	86.00
X22SED (DOHC) 16V	2198	140	86.00

Juego Completo de Reparación:

Jogo de Juntas do Motor / Full Set Gasket:

JR-537-15

R

Semi-Juego de Reparación:

Semi-Jogo de Juntas / Semi-Set Gasket:

SJ-537

R

Juego de Descarbonización:

Jogo de Juntas Superior / Head Set Gasket:

JD-537-15

R

JUNTA CULATA DE CILINDROS	TC-712-15	Ø 87.40mm	1.50mm	±0.05
Junta de cabeçote	TC-712-18	Ø 87.40mm	2.30mm	±0.05
Cylinder Head gasket				



JD-537-15



TC-712-15 - 90122951
94658175/52272664/92060517
Junta Culata de Cilindros
Junta Cabeçote



JAE-523-A - 850655
Junta Admisión
Junta Admissão



JAE-419-09 - 850656
Junta Escape
Junta Escapamento

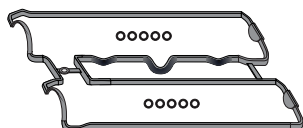

JVS-305-43 - 607647
Junta Tapa Válvula Superior
Junta Tampa Válvula Superior



JC-339-43 - 90124295/90106425
Junta Cáster
Junta Carter

2608200
Arandela 20 x 24 x 1,5mm
Arruela (Aluminio)

2722400
O'ring 47,35 x 1,78mm

2750900
O'ring 69,57 x 1,78mm



1006000
Placa admisión
Placa admissão



JSA-250 - 90128293
854933/94649659
Salida Escape
Saída Escapamento



RT-581Pol
Juego Retenes Guía de Válvulas
Jogo Retentor da Haste de Válvulas



RT-9205Pol
Retén Arbol de Levas
Retentor do Eixo Comando de Válvulas
Lx-R-H 35,00 x 48,00 x 7,00



2706200
O'ring 94 x 3mm



1012900 - 90231306
90122258/90183165
Tubo separador bomba de aceite
Tubo separador bomba de óleo



1013200 - 90106432/90106615
Block a filtro
Bloco ao filtro



2606900
Arandela 14 x 20 x 1,5mm
Arruela (Cobre)



2748700
O'ring 17,17 x 1,78mm



2751000
O'ring 16 x 2,5mm



RT-8717Pol
Retén Distribución
Retentor Dianteiro do Virabrequim
Lx-R-H 31,00 x 50,00 x 8,00



RT-9211Vit
Retén Bancada
Retentor Traseiro do Virabrequim
Mx-R AH 90,00 x 104,00 x 11,00

Productos relacionados no incluidos en el juego. Los mismos pueden ser solicitados por separado.

Produtos relacionados não incluídos no jogo. Podem ser solicitados em separado.

Related products that were not included in the set but can be ordered separately.



BU-064
Bulones para Culata de Cilindros
Parafusos de Cabeçote



JSA-250-11
Salida Escape (Láminas)
Saída Escapamento (Camadas)



JSA-300-21
Salida Escape (Anillo Malla Acero)
Saída Escap. (anel malha aço)



JAE-539-09
Junta Escape (Reforma)



JC-337-R
Junta Cáster (c/deflector)
Junta Carter (c/defletor)

Juego Completo de Reparación:

Jogo de Juntas do Motor / Full Set Gasket:

JR-520-15**R****Semi-Juego de Reparación:**

Semi-Jogo de Juntas / Semi-Set Gasket:

SJ-520**R****Juego de Descarbonización:**

Jogo de Juntas Superior / Head Set Gasket:

JD-520-15**R**

JUNTA CULATA DE CILINDROS	TC-614-15	Ø 87.50mm	1.50mm	↕
Junta de cabeçote				↕
Cylinder Head gasket				↕

DESCRIPCIÓN / Descrição / Description

CHEVROLET: Vectra B - Luv - S10
Cavalier 1996/...

MOTOR / Engine	CM ³	HP	Ø PISTON
20 NEJ	1998	112	86.00
	2200	112	86.00

ILLINOIS

CHEVROLET

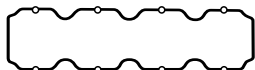
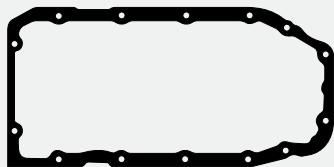
**JD-520-15****TC-614-15**Junta Culata de Cilindros
Junta Cabeçote**JSA-250 - 90128293**
854933/94649659
Salida Escape
Saída Escapamento**1177300 - 129799/94649659**
Base carburador
Base carburador**JAE-456-A - 90215011**
Junta Admisión
Junta Admissão**JAE-457-A**
Junta Admisión (Inyección)
Junta Admissão (Injeção)**JAE-458-E - 90106615**
Junta Escape
Junta Escapamento**2706100 - 90118437**
O'ring 50 x 4,2mm
carcasa termostato
carcaça termostato**JVS-300-43 - 638733/90467661**
Junta Tapa Válvula Superior
Junta Tampa Válvula Superior**1012800 - 90183165**
Válvula termostato
Válvula termostato**RT-9205Pol**
Retén Árbol de Levas
Ret. do Eixo Comando de Válvulas
Lx-R 35,00 x 48,00 x 7,00**RT-566Pol**
Jgo. Retenes Guía de Válvulas
Jogo Retentor da Haste de Válvulas**JC-357-26 - 652635/90467759**
Junta Carter Superior
Junta Carter Superior**1013200 - 90106432/90106615**
Block a filtro
Bloco ao filtro**2719700 - 90106456**
O'ring 90 x 3mm
Bomba de agua
Bomba de água**2713500 - 90128513**
O'ring 64 x 3mm**1193300 - 8930353**
90265732/90275602/9275602
Bomba de nafta
Bomba de gasolina**1013100 - 90122258/90183165**
Junta comando
Junta comando**1013000 - 94624122**
Base carburador
Base carburador**1012900 - 90231306/90122258**
Tubo separador bomba de aceite
Tubo separador bomba de óleo**2707000 - 94632563**
O'ring 15,64 x 2,62mm**2605600 - 1169011**
Arandela 14 x 20 x 2mm
Arruela (Aluminio)**2608200 - 105462**
Arandela 20 x 24 x 1,5mm
Arruela (Aluminio)**2611000**
Arandela blindada
14 x 18 x 2,5mm
Arruela blindada(Cobre)**RT-8717Pol**
Retén Distribución
Ret. Dianteiro do Virabrequim
Lx-R 31,00 x 50,00 x 8,00**RT-9211Vit**
Retén Bancada
Retentor Traseiro do Virabrequim
Mx-R AH 90,00 x 104,00 x 11,00

Productos relacionados no incluidos en el juego. Los mismos pueden ser solicitados por separado.

Produtos relacionados não incluídos no jogo. Podem ser solicitados em separado.

Related products that were not included in the set but can be ordered separately.

**BU-063**
Bulones para
Culata de Cilindros
Parafusos de Cabeçote**JB-260**
Juego Carburador
Jogo Carburador**JSA-250-11**
Salida Escape (Láminas)
Saída Escapamento
(Camadas)**JC-357-43**
Junta Carter
Junta Carter

DESCRIPCIÓN / Descrição / Description			
CHEVROLET: Optra 2007/08			
MOTOR / Engine	CM ³	HP	Ø PISTON
L34 (DOHC) 16V	2000	119	80.50

Juego Completo de Reparación: Jogo de Juntas do Motor / Full Set Gasket:	JR-554-15	R		
Semi-Juego de Reparación: Semi-Jogo de Juntas / Semi-Set Gasket:	SJ-554	R		
Juego de Descarbonización: Jogo de Juntas Superior / Head Set Gasket:				
JUNTA CULATA DE CILINDROS Junta de cabeçote Cylinder Head gasket	TC-589-15	Ø 83.00mm	1.50mm	

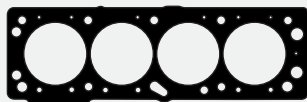

TC-589-15 - 90411937/608809/9106235
Junta Culata de Cilindros
Junta Cabeçote



1006000
Placa admisión
Placa admissão



2719700 - 90106456
O'ring 90 x 3mm
Bomba de agua
Bomba de água



JSA-309
Salida Escape
Saída Escapamento



JAE-523-A - 850655
Junta Admisión
Junta Admissão



JAE-419-09 - 850656
Junta Escape
Junta Escapamento



2750100
Guarnición termostato
Guarnição termostato



2750200
Guarnición termostato
Guarnição termostato

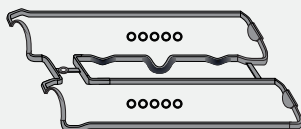

JVS-305-43 - 607647
Junta Tapa Válvula Superior
Junta Tampa Válvula Superior



1013200 - 90106432/90106615
Block a filtro
Bloco ao filtro



1118100
Junta



1120600
Junta

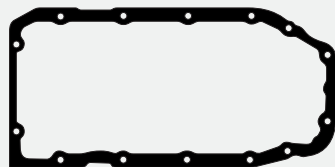

JC-357-26 - 652635/90467759
Junta Cártér Superior
Junta Carter Superior

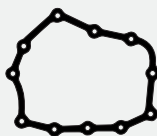

1125000
Junta distribución
Junta distribuição

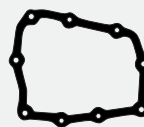

1120900
Junta distribución
Junta distribuição



1118300
Junta



1133800
Junta



1193300 - 8930353
90265732/90275602
Bomba de nafta
Bomba de gasolina



1134700 -90231306
Junta



1120700
Junta



1012900 - 90231306/90122258
Tubo separador bomba de aceite
Tubo separador bomba de óleo



1118200
Junta válvula EGR
Junta válvula EGR



1134600
Junta



1124900
Junta



RT-9211Vit
Retén Bancada
Retentor Traseiro do Virabrequim
Mx-R 90,00 x 104,00 x 11,00



RT-8717Pol
Retén Distribución
Retentor Dianteiro do Virabrequim
Lx-R 31,00 x 50,00 x 8,00



RT-9205Pol
Retén Árbol de Levas
Ret. do Eixo Comando de Válvulas
Lx-R 35,00 x 48,00 x 7,00



RT-581Pol
Jgo. Retenes Guía de Válvulas
Jogo Retentor da Haste de Válvulas

Productos relacionados no incluidos en el juego. Los mismos pueden ser solicitados por separado.

Produtos relacionados não incluídos no jogo. Podem ser solicitados em separado.

Related products that were not included in the set but can be ordered separately.



BU-064
Bulones para
Culata de Cilindros
Parafusos de Cabeçote

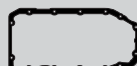

JC-357-43
Junta Cártér
Junta Carter

Juego Completo de Reparación:

Jogo de Juntas do Motor / Full Set Gasket:

JR-538-15**Semi-Juego de Reparación:**

Semi-Jogo de Juntas / Semi-Set Gasket:

SJ-538**Juego de Descarbonización:**

Jogo de Juntas Superior / Head Set Gasket:

JD-538-15

JUNTA CULATA DE CILINDROS Junta de cabeçote Cylinder Head gasket	TC-712-15	∅ 87.40mm	1.50mm	∓
	TC-712-18	∅ 87.40mm	2.30mm	∓

DESCRIPCIÓN / Descrição / Description

CHEVROLET: Vectra 1997/... - Astra

MOTOR / Engine	CM ³	HP	∅ PISTON
MPFI	2000	116	86.00
MPFI	2200	123	86.00
(SOHC) 8V			

ILLINOIS

CHEVROLET

**JD-538-15**

TC-712-15 - 90122951
94658175/52272664/92060517
Junta Culata de Cilindros
Junta Cabeçote



JSA-250 - 90128293/854933/94649659
Salida Escape
Saída Escapamento



1134600
Junta



1012800 - 90183165
Válvula termostato
Válvula termostato



JAE-526-A - 90128293
Junta Admisión
Junta Admissão



JAE-457-A
Junta Admisión
Junta Admissão



1134500
Soporte inyección TBI
Soporte injeção



1177300 - 129799/94649659
Base carburador
Base carburador

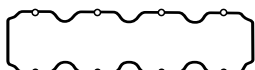

JVS-300-43 - 638733/90467661
Junta Tapa Válvula Superior
Junta Tampa Válvula Superior



JAE-458-E - 90106615
Junta Escape
Junta Escapamento



RT-566Pol
Jgo. Ret. Guía de Válvulas
Jogo Retentor da Haste
de Válvulas



RT-9205Pol
Retén Árbol de Levas
Ret. do Eixo Comando de Válv.
Lx-R-H 35,00 x 48,00 x 7,00

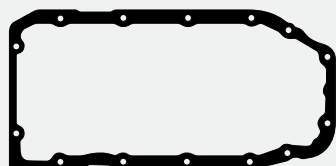

JC-357-26 - 652635/90467759
Junta Carter Superior
Junta Carter Superior

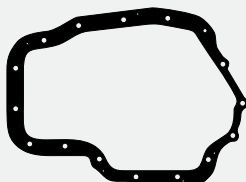

JC-365-26 - 652636
Junta Carter Inferior
Junta Carter Inferior



1134700 - 90231306
Junta



1013200 - 90106432/90106615
Block a filtro
Bloco ao filtro



1013100 - 90122258/90183165
Junta comando
Junta comando



2719700 - 90106456
O'ring 90 x 3mm
bomba de agua
bomba de água



1012900
Tubo separador bomba de aceite
Tubo separador bomba de óleo

2750400 - Juego Arandelas Goma/ Jogo Arruelas Borracha

Gráfico	Descripción/Descrição	Cant./Quant.
	O'ring 64,77x2,62mm	3
	O'ring 53,7x1,78mm	1
	O'ring 52,07x2,62mm	1
	O'ring 47,22x3,53mm	2
	O'ring 16x2mm	1
	O'ring 15,54x2,62mm	1



RT-8717Pol
Retén Distribución
Retentor Dianteiro do Virabrequim
Lx-R-H 31,00 x 50,00 x 8,00



RT-9211Vit
Retén Bancada
Retentor Traseiro do Virabrequim
Mx-R AH 90,00 x 104,00 x 11,00

Productos relacionados no incluidos en el juego. Los mismos pueden ser solicitados por separado.

Produtos relacionados não incluídos no jogo. Podem ser solicitados em separado.

Related products that were not included in the set but can be ordered separately.



BU-064
Bulones para
Culata de Cilindros
Parafusos Cabeçote



JSA-250-11
Salida Escape (Láminas)
Saída Escapamento
(Camadas)



JC-357-43
Junta Carter Superior
Junta Carter Superior



JC-365-43
Junta Carter Inferior
Junta Carter Inferior

DESCRIPCIÓN / Descrição / Description

CHEVROLET: Luv - Pick Up 1986/95
ISUZU: Amigo - Trooper II - Impulse - Aska
OPEL: Brava - Campo (5878120663)

MOTOR / Engine	CM ³	HP	Ø PISTÓN
4ZD1	2254	88/96	89.30

Juego Completo de Reparación:

Jogo de Juntas do Motor / Full Set Gasket:

JR-122-15

R

Semi-Juego de Reparación:

Semi-Jogo de Juntas / Semi-Set Gasket:

SJ-122

R

Juego de Descarbonización:

Jogo de Juntas Superior / Head Set Gasket:

JD-222-15

R

JUNTA CULATA DE CILINDROS	TC-116-15	Ø 91.30mm	1.60mm	1.60mm	1.60mm
Junta de cabeçote	TC-116-18	Ø 91.30mm	2.30mm	2.30mm	2.30mm
Cylinder Head gasket					



JD-222-15



TC-116-15 - 8943240530
 8941462440
 Junta Culata de Cilindros
 Junta Cabeçote



1183700
 Base carburador
 Base carburador

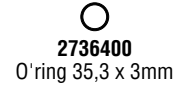

2736400
 O'ring 35,3 x 3mm



JAE-430-A - 6403172881
 8941462490
 Junta Admisión
 Junta Admissão



JAE-431-E - 6403122721
 Juego Escape
 Jogo Escapamento



2741000
 O'ring 65 x 2,5mm



JVS-262-43
 Junta Tapa Válvula Superior c/arandelas
 Junta Tampa Válvula Superior c/arruela



1183800
 Tapa termostato
 Tampa termostato



1183500 - 6403172711
 Bomba de agua
 Bomba de água

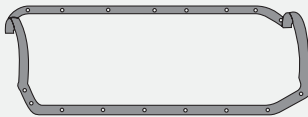

JC-319-43
 Junta Cártér
 Junta Carter



RT-8024Sil
 Reten Árbol de Levas
 Ret. do Eixo Comando de Válvulas
 Lz-R 30,00 x 45,00 x 8,00



RT-899Vit
 Juego Retenes Guía de Válvulas
 Jogo Retentor da Haste de Válvulas



1183900
 Base filtro aceite
 Base filtro óleo



1183600
 Base distribución
 Base distribuição



RT-8515Pol
 Retén Bancada
 Retentor Traseiro do Virabrequim
 Lx-R 95,00 x 118,00 x 10,00



RT-6123Pol
 Retén Distribución
 Retentor Dianteiro do Virabrequim
 Mx-R 40,00 x 56,00 x 7,00

Productos relacionados no incluidos en el juego. Los mismos pueden ser solicitados por separado.

Produtos relacionados não incluídos no jogo. Podem ser solicitados em separado.

Related products that were not included in the set but can be ordered separately.



BU-504
 Bulones para Culata de Cilindros
 Parafusos de Cabeçote



JB-243
 Juego Carburador
 Jogo Carburador



JV-192
 Juego Caja Velocidad
 Jogo Caixa de Câmbio

Juego Completo de Reparación:

Jogo de Juntas do Motor / Full Set Gasket:

JR-733**R****Semi-Juego de Reparación:**

Semi-Jogo de Juntas / Semi-Set Gasket:

Juego de Descarbonización:

Jogo de Juntas Superior / Head Set Gasket:

JD-733**R**

JUNTA CULATA DE CILINDROS	TC-933-07	∅ 89.50mm	1.55mm	∅
	TC-933-11	∅ 89.50mm	0.70mm	∅
Junta de cabeçote		∅	∅	∅
Cylinder Head gasket		∅	∅	∅

DESCRIPCIÓN / Descrição / Description

CHEVROLET: Captiva 2011/... - Malibu - Zafira

MOTOR / Engine

CM³

HP

∅ PISTON

A24XE

2384

165

88.00

LE5/LE9 Ecotec 16V

2384

149/160

88.00

ILLINOIS

CHEVROLET**JD-733**

MENÚ

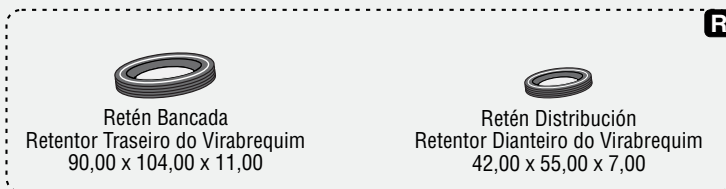
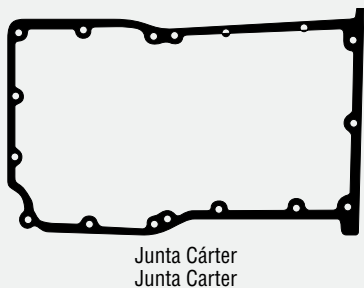
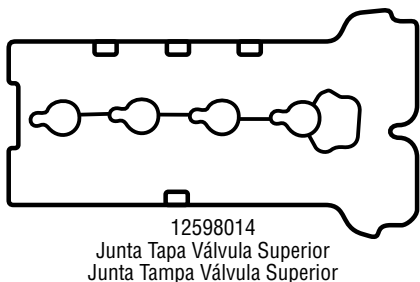
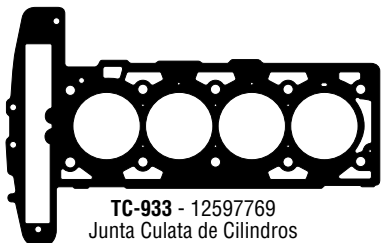

Productos relacionados no incluidos en el juego. Los mismos pueden ser solicitados por separado.

Produtos relacionados não incluídos no jogo. Podem ser solicitados em separado.

Related products that were not included in the set but can be ordered separately.

DESCRIPCIÓN / Descrição / Description

CHEVROLET: Astra - Vectra - Blazer 2000/12
Zafira - S10 2001/15

MOTOR / Engine

CM³

HP

Ø PISTON

X24XF 8V

2405

146

87.50

Juego Completo de Reparación:

Jogo de Juntas do Motor / Full Set Gasket:

JR-773

R

Semi-Juego de Reparación:

Semi-Jogo de Juntas / Semi-Set Gasket:

SJ-773

R

Juego de Descarbonización:

Jogo de Juntas Superior / Head Set Gasket:

JD-773

R

JUNTA CULATA DE CILINDROS

TC-703-15

Ø 89.50mm

1.50mm

Junta de cabeçote

TC-703-MG

Ø 89.50mm

1.50mm

Cylinder Head gasket

Ø 89.50mm

1.50mm

1.50mm
1.50mm
1.50mm
1.50mm
1.50mm
1.50mm

JD-773



TC-703 - 93282665
Junta Culata de Cilindros
Junta Cabeçote



1012800 - 90183165
Válvula termostato
Válvula termostato



JSA-250
90128293/854933/94649659
Salida Escape
Saída Escapamento



JAE-526-A - 90128293
Junta Admisión
Junta Admissão



JAE-618-A
Junta Admisión
Jogo Admissão



1133800
Junta



1134700 - 90231306
Tapa árbol de levas
Tampa Eixo Comando de Válvulas

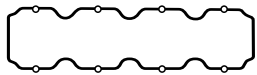

JVS-300-43 - 638733/90467661
Junta Tapa Válvula Superior
Junta Tampa Válvula Superior



JAE-458-E - 90106615
Junta Escape
Junta Escapamento



RT-566PoI
Jgo. Ret. Guía de Válvulas
Jogo Retentor da Haste
de Válvulas



RT-9205PoI
Retén Árbol de Levas
Ret. do Eixo Comando de Válvulas
Lx-R-H 35,00 x 48,00 x 7,00

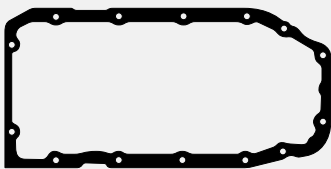

JC-357-26 - 652635/90467759
Junta Cáster Superior
Junta Carter Superior

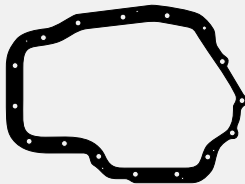

JC-365-26 - 652636
Junta Cáster Inferior
Junta Carter Inferior



1013200
90106432/90106615
Block a filtro
Bloco ao filtro



1013100
90122258/90183165
Junta comando
Junta comando



1012900
Tubo separador bomba de aceite
Tubo separador bomba de óleo



2610600 - 105452
Arandela 14 x 20 x 1,5mm
Arruela (Aluminio)

2764800 - Juego Arandelas de Goma/Jogo Arruelas de Borracha

Gráfico	Descripción/Descrição	Cant./Quant.
	O' ring 90x3mm	1
	O' ring 52,2x2,62mm	1
	O' ring 50x4,2mm	1
	O' ring 17,17x1,78mm	1
	O' ring 15,64x2,62mm	1



RT-8717PoI
Retén Distribución
Ret. Dianteiro do Virabrequim
Lx-R-H 31,00 x 50,00 x 8,00



RT-9211Vit
Retén Bancada
Retentor Traseiro do Virabrequim
Mx-R AH 90,00 x 104,00 x 11,00

Productos relacionados no incluidos en el juego. Los mismos pueden ser solicitados por separado.

Produtos relacionados não incluídos no jogo. Podem ser solicitados em separado.

Related products that were not included in the set but can be ordered separately.



JSA-250-11
Salida Escape (Láminas)
Saída Escapamento
(Camadas)



JC-357-43
Junta Cáster Superior
Junta Carter Superior



JC-365-43
Junta Cáster Inferior
Junta Carter Inferior

Juego Completo de Reparación:

Jogo de Juntas do Motor / Full Set Gasket:

JR-655**R****Semi-Juego de Reparación:**

Semi-Jogo de Juntas / Semi-Set Gasket:

SJ-655**R****Juego de Descarbonización:**

Jogo de Juntas Superior / Head Set Gasket:

JD-655**R**

JUNTA CULATA DE CILINDROS Junta de cabeçote Cylinder Head gasket	TC-703-15	∅ 89.50mm	1.50mm	↑ ↓
	TC-703-MG	∅ 88.50mm	1.50mm	↑ ↓

DESCRIPCIÓN / Descrição / Description

CHEVROLET: Captiva 2006/... - Vectra 2006/...
Astra 2004/... - Elite - Blazer - Zafira
S10 2005/...

MOTOR / Engine	CM ³	HP	∅ PISTON
Z24-SED	2405	135	87.50
X24-SFD	2405	144	87.50
MPI Flexpower	2405	144	87.50

ILLINOIS

CHEVROLET

**JD-655**

TC-703 - 93282665
Junta Culata de Cilindros
Junta Cabeçote



JAE-523-A - 850655
Junta Admisión
Junta Admissão



JAE-419-09 - 850656
Junta Escape
Junta Escapamento

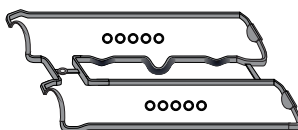

JVS-305-43 - 607647/90501944
Junta Tapa Válvula Superior
Junta Tampa Válvula Superior

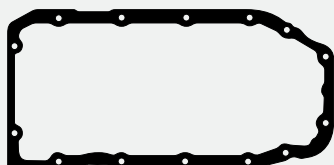

JC-357-26 - 652635/90467759
Junta Carter Superior
Junta Carter Superior



JSA-250 - 90128293/85493394649659
Salida Escape
Saída Escapamento



RT-581PoI
Guarnición termostato
Guarnição termostato



RT-581PoI
Juego Retenes Guía de Válvulas
Jogo Retentor da Haste de Válvulas



1006000
Placa admisión
Placa admissão



RT-581PoI
Guarnición termostato
Guarnição termostato

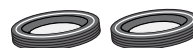

RT-9205PoI
Retén Arbol de Levas
Retentor do Eixo Comando de Válvulas
Lx-R-H 35,00 x 48,00 x 7,00



1013200 - 90106432/90106615
Block a filtro / Bloco ao filtro



1133800 - 90412686
Junta válvula a aceleración
Junta válvula ao aceleração



1012900 - 90231306/90122258/90183165
Tubo separador bomba de aceite
Tubo separador bomba de óleo

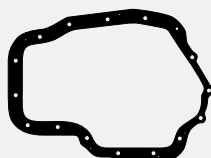

JC-365-26 - 652636
Junta Carter Inferior
Junta Carter Inferior



2608200
Arandela 20 x 24 x 1,5mm
Arruela (Aluminio)



2606900
Arandela 14 x 20 x 1mm
Arruela (Cobre)



2719700 - 90106456
O'ring 90 x 3mm
Bomba de agua / Bomba de água

2750400 - Juego Arandelas Goma/ Jogo Arruelas Borracha

Gráfico	Descripción/Descrição	Cant./Quant.
	O'ring 64,77x2,62mm	3
	O'ring 53,7x1,78mm	1
	O'ring 52,07x2,62mm	1
	O'ring 47,22x3,53mm	2
	O'ring 16x2mm	1
	O'ring 15,54x2,62mm	1



RT-8717PoI
Retén Distribución
Retentor Dianteiro do Virabrequim
Lx-R-H 31,00 x 50,00 x 8,00



RT-9211Vit
Retén Bancada
Retentor Traseiro do Virabrequim
Mx-R AH 90,00 x 104,00 x 11,00

Productos relacionados no incluidos en el juego. Los mismos pueden ser solicitados por separado.

Produtos relacionados não incluídos no jogo. Podem ser solicitados em separado.

Related products that were not included in the set but can be ordered separately.



JSA-250-11
Salida Escape (Láminas)
Saída Escapamento (Camadas)



JAE-539-09
Junta Escape
Junta Escapamento (Reforma)



JC-357-43
Junta Carter Superior
Junta Carter Superior



JC-365-43
Junta Carter Inferior
Junta Carter Inferior

DESCRIPCIÓN / Descrição / Description

CHEVROLET: Opala - C10 - A10 1974/...
Comodoro - Caravan - A10 1980/84

MOTOR / Engine	CM ³	HP	Ø PISTON
GM151	2475	90	101.60

Juego Completo de Reparación:

Jogo de Juntas do Motor / Full Set Gasket:

JR-398-15



Semi-Juego de Reparación:

Semi-Jogo de Juntas / Semi-Set Gasket:

SJ-398



Juego de Descarbonización:

Jogo de Juntas Superior / Head Set Gasket:

JD-398-15



JUNTA CULATA DE CILINDROS	TC-457-15	Ø 104.00mm	1.40mm	104.00mm	1.40mm
Junta de cabeçote					
Cylinder Head gasket					

JD-398-15

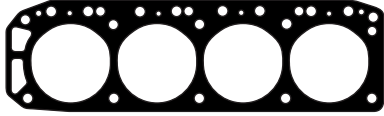

TC-457-15 - 9298684
Junta Culata de Cilindros
Junta Cabeçote



JSA-132 - C6AZ9450D
3696990/9299824
Salida Escape
Saída Escapamento



1012400 - 3788485
Entre caño múltiple
Entre tubo múltiplo



JAE-340 - 9298047
Múltiple Admisión y Escape
Coletor Admissão e Escapamento



1062000 - 3701777
Termostato
Termostato



1001900 - 7324660
Base carburador
Base carburador



JVS-202-30 - 3873851
Junta Tapa Válvula Superior
Junta Tampa Válvula Superior



JVL-155-30 - 3788549
Junta Tapa Válvula Lateral
Junta Tampa Válvula Lateral



1012500 - 3789161
Entrada agua a block
Entrada água ao bloco

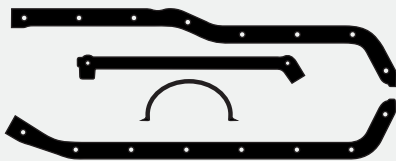

JC-324-30 - 7322169
Junta Cáster
Junta Carter



1117300 - 3923472
Tapa distribución
Tapa distribuição

RT-566Pol
Juego Retenes Guía de Válvulas
Jogo Retentor da Haste de Válvulas



1012300 - 3788478
Bomba de agua
Bomba de água



1012600 - 3789970
Bomba de aceite
Bomba de óleo



1012100 - 3705042
5752121/838263
Bomba de nafta
Bomba de gasolina



1001800 - 7328511
Bancada
Traseiro do Virabrequim

RT-9213Vit
Retén Bancada
Retentor Traseiro do Virabrequim
Mx-R 112,30 x 130,00 x 11,00

RT-6691Pol
Retén Distribución
Retentor Dianteiro do Virabrequim
Mx-R 44,85 x 61,42 x 9,52



2618600 - 3921989
Arandela 13 x 21 x 1,5mm
Arruela(Fibra)

Productos relacionados no incluidos en el juego. Los mismos pueden ser solicitados por separado.

Produtos relacionados não incluídos no jogo. Podem ser solicitados em separado.

Related products that were not included in the set but can be ordered separately.

Juego Completo de Reparación:

Jogo de Juntas do Motor / Full Set Gasket:

JR-399-15

DESCRIPCIÓN / Descrição / Description

CHEVROLET: Opala 153 1969/73
Opala A10 80/84/610 1976/...**Semi-Juego de Reparación:**

Semi-Jogo de Juntas / Semi-Set Gasket:

SJ-399**Juego de Descarbonización:**

Jogo de Juntas Superior / Head Set Gasket:

JD-399-15

JUNTA CULATA DE CILINDROS	TC-457-15	∅ 104.00mm	1.40mm	↑ ↓	↑ ↓	↑ ↓	↑ ↓
Junta de cabeçote							
Cylinder Head gasket							

MOTOR / Engine	CM ³	HP	∅ PISTON
GM153	2475	99	101.60

ILLINOIS

CHEVROLET

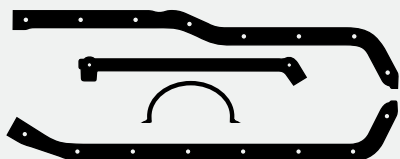
**JD-399-15****TC-457-15** - 9298684
Junta Culata de Cilindros
Junta Cabeçote**JSA-132** - C6AZ9450D
3696990/9299824
Salida Escape
Saída Escapamento**1012400** - 3788485
Entre caño múltiple
Entre tubo múltiplo**JAE-350** - 7330252
Múltiple Admisión y Escape
Coletor Admissão e Escapamento**1062000** - 3701777
Termostato
Termostato**1001900** - 7324660
Base carburador
Base carburador**JVS-202-30** - 3873851
Junta Tapa Válvula Superior
Junta Tampa Válvula Superior**JVL-155-30** - 3788549
Junta Tapa Válvula Lateral
Junta Tampa Válvula Lateral**1012500** - 3789161
Entrada agua a block
Entrada água ao bloco**JC-324-30** - 7322169
Junta Cártier
Junta Carter**1117300** - 3923472
Tapa distribución
Tapa distribuição**RT-566Pol**
Juego Retenes Guía de Válv.
Jogo Retentor da Haste de Válvulas**1001800** - 7328511
Bancada
Mancal**1012600** - 3789970
Bomba de aceite
Bomba de óleo**1012300** - 3788478
Bomba de agua
Bomba de água**1002200**
Base distribuidor**1012100** - 3705042
5752121/838263
Bomba de nafta
Bomba de gasolina**1002100**
Bomba termostato
Bomba termostato**2618600** - 3921989
Arandela 13 x 21 x 1,5mm
Arruela (Fibra)**RT-9213Vit**
Retén Bancada
Retentor Traseiro do Virabrequim
Mx-R 112,30 x 130,00 x 11,00**RT-6691Pol**
Retén Distribución
Retentor Dianteiro do Virabrequim
Mx-R 44,85 x 61,42 x 9,52

Productos relacionados no incluidos en el juego. Los mismos pueden ser solicitados por separado.

Produtos relacionados não incluídos no jogo. Podem ser solicitados em separado.

Related products that were not included in the set but can be ordered separately.

DESCRIPCIÓN / Descrição / Description **DIESEL**

CHEVROLET: Trailblazer 2012/... - S10 2012/...
JEEP: Cherokee - Liberty - Wrangler

MOTOR / Engine	CM ³	HP	Ø PISTON
ENS 16V	2768	150	94.00

Juego Completo de Reparación:

Jogo de Juntas do Motor / Full Set Gasket:

Semi-Juego de Reparación:

Semi-Jogo de Juntas / Semi-Set Gasket:

SJ-779

R

Juego de Descarbonización:

Jogo de Juntas Superior / Head Set Gasket:

JUNTA CULATA DE CILINDROS	TC-804-20 1M	Ø 95.00mm	1.10mm	±0.05
Junta de cabeçote	TC-804-20 2M	Ø 95.00mm	1.20mm	±0.05
Cylinder Head gasket	TC-804-20 3M	Ø 95.00mm	1.30mm	±0.05

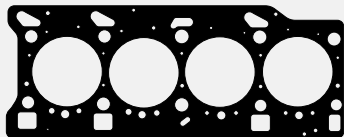

TC-804-20 1M - 68031475AA
TC-804-20 2M - 68031476AA
TC-804-20 3M - 68031477AA
Junta Culata de Cilindros
Junta Cabeçote



68027586AA
Junta Admisión
Junta Admissão



K04721794AA
Salida Escape
Saída Escapamento

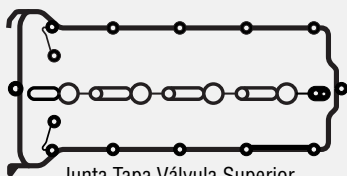

Junta Tapa Válvula Superior
Junta Tampa Válvula Superior



68027585AA
Junta Escape
Junta Escapamento



Guarnición termostato
Guarnição termostato

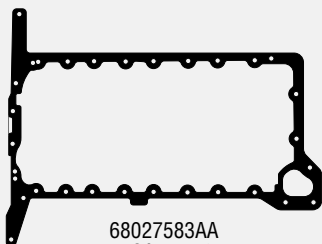

68027583AA
Junta Cáster Inferior
Junta Carter Inferior



Junta



Junta



Block a filtro
Bloco ao filtro



Junta

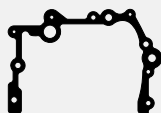

Distribución
Distribuição



Juego Retenes Guía de Válvulas
Jogo Retentor da Haste de Válvulas



Retén Bancada
Retentor Traseiro do Virabrequim
38,00 x 55,00 x 7,00



Junta
Junta



Retén Distribución
Retentor Dianteiro do Virabrequim
55,00 x 70,00 x 8,00



Retén Bancada
Retentor Traseiro do Virabrequim
100,00 x 115,00 x 7,00

R

Productos relacionados no incluidos en el juego. Los mismos pueden ser solicitados por separado.

Produtos relacionados não incluídos no jogo. Podem ser solicitados em separado.

Related products that were not included in the set but can be ordered separately.

Juego Completo de Reparación:

Jogo de Juntas do Motor / Full Set Gasket:

JR-117-15**Semi-Juego de Reparación:**

Semi-Jogo de Juntas / Semi-Set Gasket:

Juego de Descarbonización:

Jogo de Juntas Superior / Head Set Gasket:

JD-103-15

JUNTA CULATA DE CILINDROS	TC-156-15	∅ 103.80mm	1.60mm	↑ ↓
Junta de cabeçote				↑ ↓
Cylinder Head gasket				↑ ↓

DESCRIPCIÓN / Descrição / Description

CHEVROLET: Súper Special - Rally Sport 1962/68 - 400/63 SS - 6 Cilindros

MOTOR / Engine	CM ³	HP	∅ PISTON
194	3185		90.48

ILLINOIS

CHEVROLET

JD-103-15

TC-156-15 - 3788416
Junta Culata de Cilindros
Junta Cabeçote



JSA-132 - C6AZ9450D/3696990
Salida Escape
Saída Escapamento



1012400 - 3788485
Entre caño múltiple
Entre tubo múltiplo



JAE-138 - 3824438/3788487
Múltiple Admisión y Escape
Coletor Admissão e Escapamento



1062000 - 3701777
Termostato
Termostato



1012500 - 3789161
Entrada agua a block
Entrada água a bloco



JVS-115-30 - 3788499/3828276
Junta Tapa Válvula Superior
Junta Tampa Válvula Superior



JVL-114-30 - 3788497
Junta Tapa Válvula Lateral
Junta Tampa Válvula Lateral

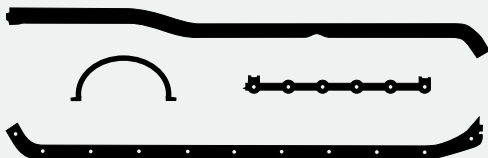

JC-120-30 - 3791198
Junta Cáster
Junta Carter



1012200 - 3788471
Tapa distribución
Tampa distribuição



1012300 - 3788478
Bomba de agua
Bomba de água



1131000
Base bomba de aceite
Base bomba de óleo



1012600 - 3789970
Bomba de aceite
Bomba óleo



1012100 - 3705042
5752121/838263
Bomba de nafta
Bomba de gasolina

Productos relacionados no incluidos en el juego. Los mismos pueden ser solicitados por separado

Produtos relacionados não incluídos no jogo. Podem ser solicitados em separado / Related products that were not included in the set but can be ordered separately.



BU-065
Bulones para
Culata de Cilindros
Parafusos de Cabeçote



JB-114
Jgo. Carburador
Jogo Carburador



1085000
Junta Diferencial
Junta Diferencial
(Dana 44)



JVS-115-23
Junta Tapa Válvula Sup.
Junta Tampa
Válvula Superior



JAE-138-09
Múltiple Admisión
y Escape
Coletor Admissão
e Escapamento



RT-504Pol
Juego Retenes
Guía de Válvulas
Jogo Retedor da
Haste de Válvulas



RT-6691Pol
Retén Distribución
Retedor Diant. do Virabrequim
Mx-R 44,85 x 61,42 x 9,52

DESCRIPCIÓN / Descrição / Description

CHEVROLET: Captiva 2008/12
Trailblazer 2013/17 - Omega 2005/12
Camaro 2011/...

MOTOR / Engine	CM ³	HP	Ø PISTON
10HM V6 24V	3195	225	89.00

--	--	--	--

--	--	--	--

Juego Completo de Reparación:

Jogo de Juntas do Motor / Full Set Gasket:

JR-801-11

R

Semi-Juego de Reparación:

Semi-Jogo de Juntas / Semi-Set Gasket:

Juego de Descarbonización:

Jogo de Juntas Superior / Head Set Gasket:

JUNTA CULATA DE CILINDROS

Junta de cabeçote

Cylinder Head gasket

TC-665-11

Ø 90.00mm

TC-666-11

Ø 90.00mm



TC-665-11 - 1114179K00
Junta Culata de Cilindros (Derecha)
Junta Cabeçote (Direita)

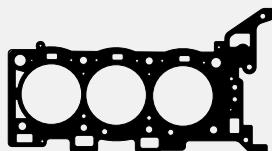

TC-666-11 - 1114279K00
Junta Culata de Cilindros (Izquierda)
Junta Cabeçote (Esquerda)



Junta Admisión
Junta Admissão



Junta Tapa Válvula Superior (Derecha)
Junta Tampa Válvula Superior (Direita)



Junta Tapa Válvula Superior (Izquierda)
Junta Tampa Válvula Superior (Esquerda)



Junta Escape
Junta Escapamento



Junta



Junta Escape
Junta Escapamento



Bomba de agua
Bomba d'água



Retén Distribución
Retentor Dianteiro do Virabrequim
50,00 x 760,00 x 11,00



Juego Retenes Guía de Válvulas
Jogo Retentor haste de Válvulas

Productos relacionados no incluidos en el juego. Los mismos pueden ser solicitados por separado.

Produtos relacionados não incluídos no jogo. Podem ser solicitados em separado.

Related products that were not included in the set but can be ordered separately.

Juego Completo de Reparación:

Jogo de Juntas do Motor / Full Set Gasket:

JR-232-15**Semi-Juego de Reparación:**

Semi-Jogo de Juntas / Semi-Set Gasket:

Juego de Descarbonización:

Jogo de Juntas Superior / Head Set Gasket:

JD-103-15

JUNTA CULATA DE CILINDROS	TC-156-15	∅103.80mm	1.60mm	↑ ↓ ↑ ↓ ↑ ↓ ↑ ↓
Junta de cabeçote				↑ ↓ ↑ ↓ ↑ ↓ ↑ ↓
Cylinder Head gasket				↑ ↓ ↑ ↓ ↑ ↓ ↑ ↓

DESCRIPCIÓN / Descrição / Description

CHEVROLET: 400 1964/72 - RS Malibu
Pick Up Súper 1964/69 - Silverado Cheyenne
Chevy 7 Bancadas 1968/78 Opala C10 C20

MOTOR / Engine	CM ³	HP	∅ PISTON
230	3769		98.43
250	4047		98.43

ILLINOIS

CHEVROLET

JD-103-15

TC-156-15 - 3788416
Junta Culata de Cilindros
Junta Cabeçote



JSA-132 - C6AZ9450D/3696990
Salida Escape
Saída Escapamento



1012400 - 3788485
Entre caño múltiple
Entra tubo coletor



JAE-138 - 3824438/3788487
Múltiple Admisión y Escape
Coletor Admissão e Escapamento



1012500 - 3789161
Entrada agua a block
Entrada água ao bloco



1062000 - 3701777
Termostato
Termostato



JVS-115-30 - 3788499/3828276
Junta Tapa Válvula Superior
Junta Tampa Válvula Superior



JVL-114-30 - 3788497
Junta Tapa Válvula Lateral
Junta Tampa Válvula Lateral

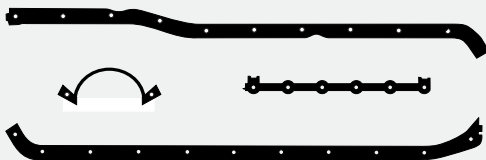

JC-236-30 - 3832420/5751118
Junta Cártter
Junta Carter



1012200 - 3788471
Tapa distribución
Tampa distribuição



1012300 - 3788478
Bomba de agua
Bomba de água



1131000
Base bomba de aceite
Base bomba de óleo



1012600 - 3789970
Bomba de aceite
Bomba de óleo



1012100 - 3705042
5752121/838263
Bomba de nafta
Bomba de gasolina

Productos relacionados no incluidos en el juego. Los mismos pueden ser solicitados por separado

Produtos relacionados não incluídos no jogo. Podem ser solicitados em separado / Related products that were not included in the set but can be ordered separately.

**BU-065**

Bulones p/culata de Cil.
Parafusos de Cabeçote

**JV-102**

Juego Caja Velocidad
Jogo Caixa de Câmbio

**JV-129**

Juego Caja Velocidad
Jogo Caixa de Câmbio

**JAE-138-09**

Múltiple Admisión y Escape
Coletor Admissão e Escapamento

**JC-236-15**

JC-236-23
Junta Cártter

**RT-504PoI**

Jgo. Ret. Guía de Válvulas
Jogo Retenedor da Haste de Válvulas

**JB-163**

Jgo. Carburador
Jogo Carburador

**JB-111**

Jgo. Carburador
Jogo Carburador

**JB-113**

Jgo. Carburador
Jogo Carburador

**1085200**

Junta Diferencial
Junta Diferencial
(Dana 44)

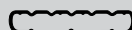
**JVS-115-23**

Tapa de Válvula Sup.
Tampa
Válvula Superior

**1085600**

Junta Diferencial
Junta diferencial
(Eaton 200272)

**RT-6691PoI**

Retén Distribución Mx-R
Ret. Dianteiro do Virabrequim
44,85 x 61,42 x 9,52

DESCRIPCIÓN / Descrição / Description **DIESEL**

CHEVROLET: Pick Up Apache C10 3.9/16
1953/59 - Bel Air - Impala 1953/62
Camión 4400 1957/... (7364640)

MOTOR / Engine	CM ³	HP	Ø PISTON
235	3851	130	90.48

Juego Completo de Reparación:

Jogo de Juntas do Motor / Full Set Gasket:

JR-118-05



Semi-Juego de Reparación:

Semi-Jogo de Juntas / Semi-Set Gasket:

Juego de Descarbonización:

Jogo de Juntas Superior / Head Set Gasket:

JUNTA CULATA DE CILINDROS	TC-154-05		1.80mm	
Junta de cabeçote				
Cylinder Head gasket				

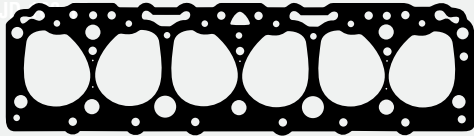

TC-154-05 - 3703179/7364640
Junta Culata de Cilindros
Junta Cabeçote



JAE-140 - 3694871
Múltiple Admisión y Escape
Coletor Admissão e Escapamento



JVS-117-30 - 3708648
Junta Tapa Válvula Superior
Junta Tampa Válvula Superior



JVL-116-30 - 3701542
Junta Tapa Válvula Lateral
Junta Tampa Válvula Lateral



JC-118-30 - 3714551
Junta Cártel
Junta Carter



1197000 - 7015367
Intermedia/Intermediária carburador



1196800 - 3692799
Base carburador



1116100 - 838206
Tapa distribución
Tampa distribuição



1182500 - 3835412
Placa distribución
Placa distribuição



JSA-132 - C6AZ9450D/3696990
Salida Escape
Saída Escapamento



1106200 - 838451/839166
Tapa bomba de aceite
Tampa bomba de óleo



1116800 - 839173
Bomba de aceite
Bomba de óleo



1062000 - 3701777
Termostato



1198900 - 7004480
Tapa carburador
Tampa carburador



1116600 - 839470
Bomba de agua
Bomba de água



1107000 - 838297
Vaso termostato
Copo termostato



1107200 - 838263
Bomba de nafta
Bomba de gasolina



1196900 - 3835572/838290
Entre caño múltiple
Entre tubo coletor



1106900 - 1523096
Vaso bomba de nafta
Copo bomba de gasolina



1197300 - 3734991/3836162
Bomba de agua
Bomba d'água



1116700 - 839174
Bomba de aceite
Bomba de óleo



RT-525Pol
Juego Retenes Guía de Válvulas
Jogo Retedor da Haste de Válvulas



RT-6691Pol
Retén Distribución
Retedor Dianteiro do Virabrequim
Mx-R 44,85 x 61,42 x 9,52

Productos relacionados no incluidos en el juego. Los mismos pueden ser solicitados por separado.

Produtos relacionados não incluídos no jogo. Podem ser solicitados em separado.

Related products that were not included in the set but can be ordered separately.



JSA-171-22
Salida Escape
(Fundición)
Saída Escapamento
(Ferro)



JSA-171-21
Salida Escape
(Anillo Malla Acero)
Saída Escapamento
(Anel Malha Aço)

Juego Completo de Reparación:

Jogo de Juntas do Motor / Full Set Gasket:

JR-334-15**Semi-Juego de Reparación:**

Semi-Jogo de Juntas / Semi-Set Gasket:

Juego de Descarbonización:

Jogo de Juntas Superior / Head Set Gasket:

JUNTA CULATA DE CILINDROS	TC-524-15	∅ 103.80mm	1.60mm	↑ ↓ ↑ ↓ ↑ ↓ ↑ ↓
Junta de cabeçote				↑ ↓ ↑ ↓ ↑ ↓ ↑ ↓
Cylinder Head gasket				↑ ↓ ↑ ↓ ↑ ↓ ↑ ↓

DESCRIPCIÓN / Descrição / Description

CHEVROLET: C20 Custom
Pick Up C10 1989/...

MOTOR / Engine	CM ³	HP	∅ PISTON
250	4097		98.47

ILLINOIS

CHEVROLET



TC-524-15
Junta Culata de Cilindros
Junta Cabeçote



JSA-152 - 7330625/0490301
Salida Escape
Saída Escapamento



1012400 - 3788485
Entre caño múltiple
Entre tubo coletor



JAE-138 - 3824438/3788487
Múltiple Admisión y Escape
Coletor Admissão e Escapamento



1012100 - 3705042
5752121/838263
Bomba de nafta
Bomba de gasolina



1012300 - 3788478
Bomba de agua
Bomba de água



JVS-116-30 - 3873853
Juntas Tapa Válvula Superior
Juntas Tampa Válvula Superior



JVL-114-30 - 3788497
Junta Tapa Válvula Lateral
Junta Tampa Válvula Lateral

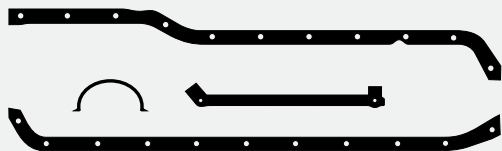

JC-113-30 - 3873853
Junta Cárter
Junta Carter

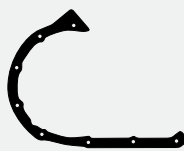

1117300 - 3923472
Tapa distribución
Tampa distribuição



1012000 - 3701777
Salida agua
Saída água



1012500 - 3789161
Entrada agua a block
Entraga água ao bloco

Productos relacionados no incluidos en el juego. Los mismos pueden ser solicitados por separado

Produtos relacionados não incluídos no jogo. Podem ser solicitados em separado / Related products that were not included in the set but can be ordered separately.



BU-065
Bulones para
Culata de Cilindros
Parafusos de Cabeçote



JV-153
Juego Caja Velocidad
Jogo Caixa de Câmbio



1158100
Diferencial
Diferencial
(Dana 46)



JAE-138-09
Múltiple Admisión y Escape
Coletor Admissão e Escapamento



RT-504Pol
Jgo. Ret. Guía de Válvulas
Jogo Retentor da Haste
de Válvulas



RT-9213Vit
Retén Bancada
Ret. Traseiro do Virabrequim
Mx-Hel 112,30 x 130,00 x 11,00



RT-6691Pol
Retén Distribución
Ret. Dianteiro do Virabrequim
Mx-R 44,85 x 61,42 x 9,52



JSA-230-21
Salida Escape (anillo malla acero)
Saída Escapamento
(anel malha aço)



JSA-230-22
Salida Escape (Fundicion)
Saída Escape (Ferro)

DESCRIPCIÓN / Descrição / Description

CHEVROLET: Pick Up 7 Bancadas
Silverado - Cheyenne

MOTOR / Engine	CM ³	HP	Ø PISTON
250	4097		98.43

Juego Completo de Reparación:

Jogo de Juntas do Motor / Full Set Gasket:

JR-318-15



Semi-Juego de Reparación:

Semi-Jogo de Juntas / Semi-Set Gasket:

Juego de Descarbonización:

Jogo de Juntas Superior / Head Set Gasket:

JUNTA CULATA DE CILINDROS	TC-424-15	Ø 102.20mm	1.70mm	102.20mm
Junta de cabeçote				
Cylinder Head gasket				

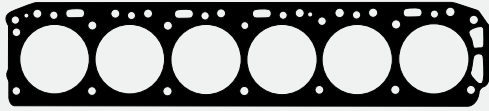

TC-424-15 - 7321827
Junta Culata de Cilindros
Junta Cabeçote



JSA-132 - C6AZ9450D/3696990
Salida Escape
Saída Escapamento



1012300 - 3788478
Bomba de agua
Bomba de água

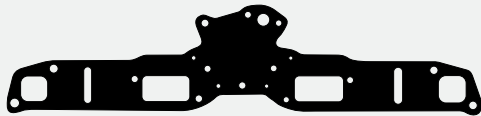

JAE-334-09
Múltiple Admisión y Escape
Coletor Admissão e Escapamento



1012600 - 3789970
Bomba de aceite
Bomba de óleo



1012400 - 3788485
Entre caño múltiple
Entre tubo coletor

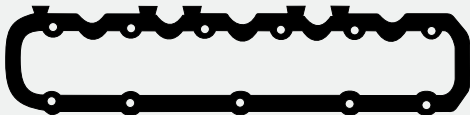

JVS-212-30
Junta Tapa Válvula Superior
Junta Tampa Válvula Superior



JVL-156-30
Junta Tapa Válvula Lateral
Junta Tampa Válvula Lateral

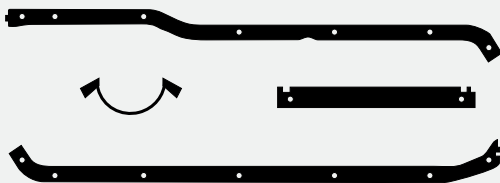

JC-253-30
Junta Cártel
Junta Carter



1012200 - 3788471
Tapa distribución
Tampa distribuição



1062000 - 371777
Termostato



1012500 - 3789161
Entrada agua a block
Entrada água ao bloco



RT-504PoI
Juego Retenes Guía de Válvulas
Jogo Retentor da Haste de Válvulas



RT-9213ViT
Retén Bancada
Retentor Traseiro do Virabrequim
Mx-R 112,30 x 130,00 x 11,00



RT-6691PoI
Retén Distribución
Ret. Dianteiro do Virabrequim
Mx-R 44,85 x 61,42 x 9,52



1012100 - 3705042
5752121/838263
Bomba de nafta
Bomba de gasolina

Productos relacionados no incluidos en el juego. Los mismos pueden ser solicitados por separado.

Produtos relacionados não incluídos no jogo. Podem ser solicitados em separado.

Related products that were not included in the set but can be ordered separately.



JB-178
Juego Carburador
Jogo Carburador



1127000
Junta Diferencial
Jogo Diferencial

Juego Completo de Reparación:

Jogo de Juntas do Motor / Full Set Gasket:

JR-691-07

DESCRIPCIÓN / Descrição / Description

CHEVROLET: S10 1996/2011 - Blazer - Zafari
Sonoma

MOTOR / Engine

CM³

HP

Ø PISTON

Vortec 262

4294

180

101.60

ILLINOIS

CHEVROLET

Semi-Juego de Reparación:

Semi-Jogo de Juntas / Semi-Set Gasket:

Juego de Descarbonización:

Jogo de Juntas Superior / Head Set Gasket:

JUNTA CULATA DE CILINDROS	TC-704-07	∅ 104.00mm	0.80mm	↑ ↓
Junta de cabeçote		∅	↑ ↓	↑ ↓
Cylinder Head gasket		∅	↑ ↓	↑ ↓

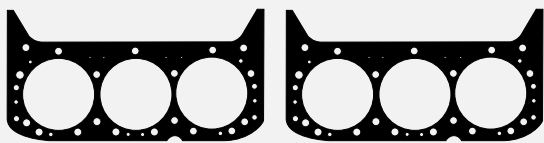

TC-704-07
Junta Culata de Cilindros
Junta de Cabeçote

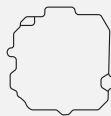

Junta



Chupador de aceite
Pescador de óleo



Junta Admisión
Junta Admissão



Junta Escape
Junta Escapamento



Distribución
Distribuição



Junta Tapa de Válvula Superior
Junta Tampa de Válvula Superior



Junta



Junta



Junta Carter
Junta Cárter



Junta



Junta



Juego Retenes Guía de Válvulas
Jogo Retentor haste de Válvulas



Retén Bancada
Retentor Traseiro do Virabrequim



Retén Distribución
Retentor Dianteiro do Virabrequim

Productos relacionados no incluidos en el juego. Los mismos pueden ser solicitados por separado.

Produtos relacionados não incluídos no jogo. Podem ser solicitados em separado.

Related products that were not included in the set but can be ordered separately.



MENÜ

DESCRIPCIÓN / Descrição / Description

CHRYSLER: PT Cruiser 2005/...

MOTOR / Engine	CM ³	HP	Ø PISTON
EDZ 16V	2429	140	87.50

Juego Completo de Reparación:

Jogo de Juntas do Motor / Full Set Gasket:

JR-802-11

R

Semi-Juego de Reparación:

Semi-Jogo de Juntas / Semi-Set Gasket:

Juego de Descarbonización:

Jogo de Juntas Superior / Head Set Gasket:

JUNTA CULATA DE CILINDROS	TC-664-11	Ø 88.50mm	0.80mm	↑ ↓
Junta de cabeçote	TC-664-15	Ø 90.00mm	1.80mm	↑ ↓
Cylinder Head gasket				↑ ↓

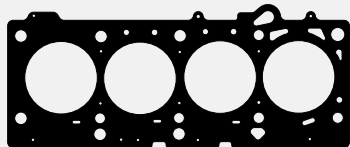

TC-664-11 - 4884407AA/48844443AD
Junta Culata de Cilindros
Junta Cabeçote



Salida de Escape
Saída escapamento



Junta



Juego Admisión
Jogo Admissão



Juego Admisión
Jogo Admissão



Junta Escape
Junta Escapamento

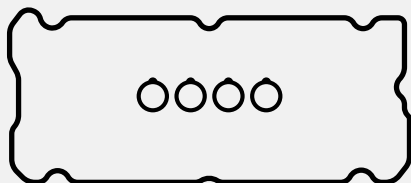

Junta Tapa Válvula Superior
Junta Tampa Válvula Superior



Junta



Bomba de agua
Bomba de água

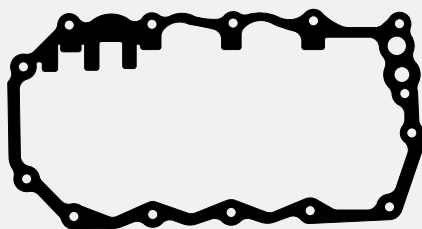

Junta Cáster
Junta Carter



Junta



Junta



Junta



Retén Árbol de Leva
Retentor do Eixo Comando
de Válvulas



Retén Distribución
Retentor Dianteiro
do Virabrequim



Retén Bancada
Retentor Traseiro
do Virabrequim



Juego Retenes Guía de Válvulas
Jogo Retentor da Haste de Válvulas

R

Productos relacionados no incluidos en el juego. Los mismos pueden ser solicitados por separado.

Produtos relacionados não incluídos no jogo. Podem ser solicitados em separado.

Related products that were not included in the set but can be ordered separately.

Juego Completo de Reparación:

Jogo de Juntas do Motor / Full Set Gasket:

JR-803-11**R**

DESCRIPCIÓN / Descrição / Description

CHRYSLER: Caravan 1995/00 - Voyager**Semi-Juego de Reparación:**

Semi-Jogo de Juntas / Semi-Set Gasket:

Juego de Descarbonización:

Jogo de Juntas Superior / Head Set Gasket:

JUNTA CULATA DE CILINDROS	TC-657-11	∅ 88.50mm	1.00mm	↑ ↓
Junta de cabeçote				↑ ↓
Cylinder Head gasket				↑ ↓

MOTOR / Engine	CM ³	HP	∅ PISTON
B00 16V	2429	151	87.50

ILLINOIS

CHRYSLER

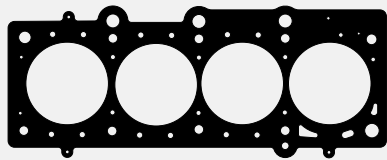

TC-657-11 - 4694324
Junta Culata de Cilindros
Junta Cabeçote



Salida escape
Saída escapamento



Junta



Junta Admisión
Junta Admissão

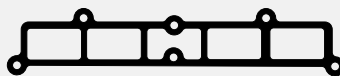

Junta Admisión
Junta Admissão



Junta Escape
Junta Escapamento

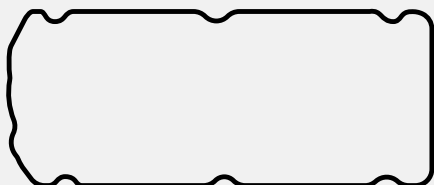

Junta Tapa Válvula Superior
Junta Tampa Válvula Superior



Junta



Junta

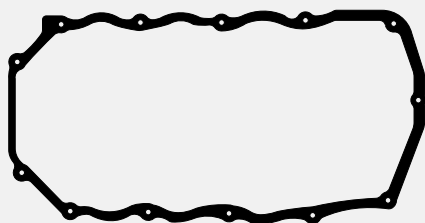

Junta Cárter
Junta Carter



Junta



Junta



Bomba de agua
Bomba de água



Retén Árbol de Levas
Retentor do Eixo Comando de Válvulas



Retén Auxiliar
Retentor Auxiliar



Juego Retenes Guía de Válvulas
Jogo Retentor Haste de Válvulas



Retén Bancada
Retentor Traseiro do Virabrequim



Retén Distribución
Retentor Dianteiro do Virabrequim

Productos relacionados no incluidos en el juego. Los mismos pueden ser solicitados por separado.

Produtos relacionados não incluídos no jogo. Podem ser solicitados em separado.

Related products that were not included in the set but can be ordered separately.

DESCRIPCIÓN / Descrição / Description

CHRYSLER: Stratus V6 2001/06
DODGE: Journey V6 2008/...

MOTOR / Engine	CM ³	HP	Ø PISTON
EER	2736	181	86.00
EES	2736	177	86.00

Juego Completo de Reparación:

Jogo de Juntas do Motor / Full Set Gasket:

JR-804-11

R

Semi-Juego de Reparación:

Semi-Jogo de Juntas / Semi-Set Gasket:

Juego de Descarbonización:

Jogo de Juntas Superior / Head Set Gasket:

JUNTA CULATA DE CILINDROS	TC-661-11	Ø 87.50mm	1.30mm	↕
Junta de cabeçote	TC-662-11	Ø 87.50mm	1.30mm	↕
Cylinder Head gasket				↕



TC-661-11 - 02298148356/4663694AC
 Junta Culata de Cilindros (Derecha)
 Junta Cabeçote (Direita)



TC-662-11 - 02270141341/4663693AC
 Junta Culata de Cilindros (Izquierda)
 Junta Cabeçote (Esquerda)



Bomba de agua
 Bomba de água



Junta Escape
 Junta Escapamento



Junta Admisión
 Junta Admissão



Junta Admisión
 Junta Admissão



Junta Tapa Válvula Superior (Derecha)
 Junta Tampa Válvula Superior (Direita)



Junta Tapa Válvula Superior (Izquierda)
 Junta Tampa Válvula Superior (Esquerda)



Junta



Junta

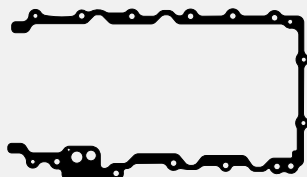

Junta Cáster
 Junta Carter

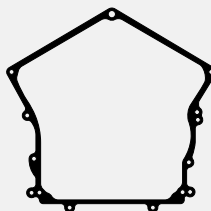

Distribución
 Distribuição



Junta

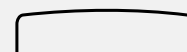

Junta



Retén Bancada
 Retentor Traseiro do Virabrequim



Retén Distribución
 Retentor Dianteiro do Virabrequim



Juego Retenes Guía de Válvulas
 Jogo Retentor da Haste de Válvulas

Productos relacionados no incluidos en el juego. Los mismos pueden ser solicitados por separado.

Produtos relacionados não incluídos no jogo. Podem ser solicitados em separado.

Related products that were not included in the set but can be ordered separately.

Juego Completo de Reparación:

Jogo de Juntas do Motor / Full Set Gasket:

JR-472-15**R**

DESCRIPCIÓN / Descrição / Description

CHRYSLER: Caravan - Grand Caravan - Imperial
Voyager - Grand Voyager - New Yorker
Town & Country 1990/99

MOTOR / Engine

CM³

HP

Ø PISTON

201 (R00) V6

3301

152/162

93.00

Juego de Descarbonización:

Jogo de Juntas Superior / Head Set Gasket:

JUNTA CULATA DE CILINDROS	TC-685-15	Ø 96.00mm	1.80mm	1.80mm
Junta de cabeçote	TC-686-15	Ø 96.00mm	1.80mm	1.80mm
Cylinder Head gasket				

ILLINOIS

CHRYSLER

TC-685-15
Junta Culata de Cilindros
Junta Cabeçote



TC-686-15
Junta Culata de Cilindros
Junta Cabeçote



JSA-305
Salida Escape
Saída Escapamento



JAE-367-E
Junta Escape
Junta Escapamento



1002600
Base termostato
Base termostato



1002700
Junta árbol de levas
Junta árvore de comando

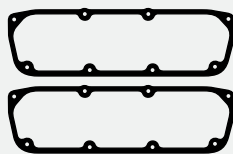

JVS-333-43
Junta Tapa Válvula Superior
Junta Tampa Válvula Superior



1002500
Tapa distribución
Tampa distribuição



1002800
Porta Retén Bancada
Flange Traseiro do Virabrequim

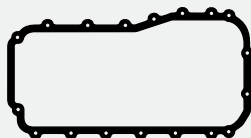

JC-369-43
Junta Cártel
Junta Carter

2751300
O'ring 21,82 x 3,53mm

2700900
O'ring 20,30 x 2,62mm



2748200
Entrada y salida tubo admisión
Entrada e saída tubo admissão
O'ring 34,4 x 3,2mm



2756300
Arandela (Goma)
Arruela (Borracha)
24,6 x 31 x 4,5mm



2756200
Arandela (Goma)
Arruela (Borracha)
35 x 42 x 4,5mm



2724800
O'ring 7,5 x 3,53mm



2632000
Arandela 13 x 23 x 1,5mm
Arruela (Cobre)



RT-9663Vit
Retén Bancada
Retenedor Traseiro do Virabrequim
A 278-R 91,00 x 110,00 x 10,00

Productos relacionados no incluidos en el juego. Los mismos pueden ser solicitados por separado.

Produtos relacionados não incluídos no jogo. Podem ser solicitados em separado.

Related products that were not included in the set but can be ordered separately.

DESCRIPCIÓN / Descrição / Description

DAIHATSU: Sirion 1998/... 12V
(0411197201000)

MOTOR / Engine	CM ³	HP	Ø PISTON
EJ-DE	989	54	72.00

Juego Completo de Reparación:

Jogo de Juntas do Motor / Full Set Gasket:

JR-690-11



Semi-Juego de Reparación:

Semi-Jogo de Juntas / Semi-Set Gasket:

Juego de Descarbonización:

Jogo de Juntas Superior / Head Set Gasket:

JUNTA CULATA DE CILINDROS	TC-923-07	Ø 73.50mm	1.50mm	↑ ↓
Junta de cabeçote		Ø	↑ ↓	↑ ↓
Cylinder Head gasket		Ø	↑ ↓	↑ ↓



TC-923 - 1111597201000
Junta Culata de Cilindros
Junta Cabeçote



Junta



Arandela Goma
Arruela Borracha



Junta Admisión
Junta Admissão



Junta Escape
Junta Escapamento



Salida Escape
Saída Escapamento

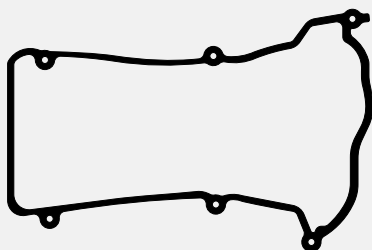

Junta Tapa de Válvula Superior
Junta Tampa de Válvula Superior



Distribución
Distribuição



Junta



Juego Retenes Guía de Válvulas
Jogo Retentor da Haste de Válvulas



Retén Bancada
Retentor Traseiro do
Virabrequim



Retén Árbol de Leva
Retentor do Eixo Comando
de Válvulas



Retén Distribución
Retentor Dianteiro do
Virabrequim

Productos relacionados no incluidos en el juego. Los mismos pueden ser solicitados por separado.

Produtos relacionados não incluídos no jogo. Podem ser solicitados em separado.

Related products that were not included in the set but can be ordered separately.

Juego Completo de Reparación:

Jogo de Juntas do Motor / Full Set Gasket:

JR-805-11**R**

DESCRIPCIÓN / Descrição / Description

DAIHATSU: Sirion - Storia 2005/...**TOYOTA:** IQ - Aygo - Yaris 2008/...**CITROEN:** C1 2005/...**PEUGEOT:** 107 2005/...

MOTOR / Engine	CM ³	HP	Ø PISTON
1KR-FE	998	65	71.00

ILLINOIS.

DAIHATSU

Semi-Juego de Reparación:

Semi-Jogo de Juntas / Semi-Set Gasket:

Juego de Descarbonización:

Jogo de Juntas Superior / Head Set Gasket:

JUNTA CULATA DE CILINDROS	TC-674-11	Ø 72.00mm	0.60mm	↑ ↓
Junta de cabeçote				↑ ↓
Cylinder Head gasket				↑ ↓

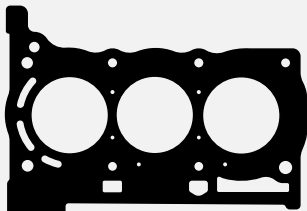

TC-674-11 - 1111540060/0209EC
Junta Culata de Cilindros
Junta Cabeçote



Junta Escape
Junta Escapamento



Junta

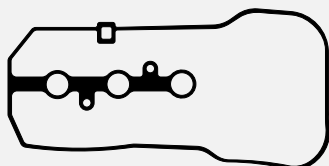

Junta Tapa Válvula Superior
Junta Tampa Válvula Superior



Junta Admisión
Junta Admissão



Juego Retenes Guía de Válvulas
Jogo Retentor haste de Válvulas



Retén Distribución
Retentor Dianteiro do Virabrequim



Retén Árbol de Leva
Retentor do Eixo Comando de Válvulas

R

Productos relacionados no incluidos en el juego. Los mismos pueden ser solicitados por separado.

Produtos relacionados não incluídos no jogo. Podem ser solicitados em separado.

Related products that were not included in the set but can be ordered separately.

DESCRIPCIÓN / Descrição / Description

DAIHATSU: Charade - Feroza 1988/...
Terios 1992/... - Applausse 1989/...
Rocky 1990/... (0411187108/09/11/12/16/23)

MOTOR / Engine	CM ³	HP	Ø PISTON
HC	1296	60/65	76.00
HD	1590	90/95	76.00

Juego Completo de Reparación:

Jogo de Juntas do Motor / Full Set Gasket:

JR-689-07

R

Semi-Juego de Reparación:

Semi-Jogo de Juntas / Semi-Set Gasket:

Juego de Descarbonización:

Jogo de Juntas Superior / Head Set Gasket:

JUNTA CULATA DE CILINDROS	TC-124-15	Ø 77.00mm	1.50mm	↑ ↓
Junta de cabeçote				↑ ↓
Cylinder Head gasket				↑ ↓

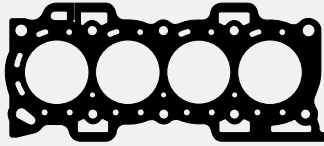

TC-124-15 - 1111587105/06
Junta Culata de Cilindros
Junta Cabeçote



Junta



Junta



Junta Admisión
Junta Admissão



Junta Escape
Junta Escapamento



Junta

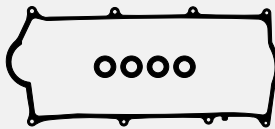

Junta Tapa de Válvula Superior
Junta Tampa de Válvula Superior



Junta



Junta



Junta



Retén Bancada
Retentor Traseiro do
Virabrequim



Juego Retenes Guía de Válvulas
Jogo Retentor da Haste
de Válvulas



Retén Distribución
Retentor Dianteiro do
Virabrequim



Retén Árbol de Leva
Retentor do Eixo Comando
de Válvulas

R

Productos relacionados no incluidos en el juego. Los mismos pueden ser solicitados por separado.

Produtos relacionados não incluídos no jogo. Podem ser solicitados em separado.

Related products that were not included in the set but can be ordered separately.

Juego Completo de Reparación:

Jogo de Juntas do Motor / Full Set Gasket:

JR-128-15

DESCRIPCIÓN / Descrição / Description

DI TELLA: Siam Ditella 1500 - Argenta 1961/67
 Traveller - Riley 1500 - Pick Up Riley 1500
 Magnette 1622 60/66 - Morris 1650
 (137541/48G131)

MOTOR / Engine	CM ³	HP	Ø PISTON
BMC 1500	1489		73.02
BMC 1600	1622		76.20

ILLINOIS

DI TELLA

Semi-Juego de Reparación:

Semi-Jogo de Juntas / Semi-Set Gasket:

Juego de Descarbonización:

Jogo de Juntas Superior / Head Set Gasket:

JUNTA CULATA DE CILINDROS	TC-184-15	Ø 76.60mm	1.60mm	↑ ↓
Junta de cabeçote				↑ ↓
Cylinder Head gasket				↑ ↓

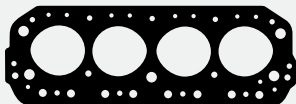

TC-184-15 - 137541
 Junta Culata de Cilindros
 Junta Cabeçote



1195500 - 8G619
 Filtro aceite
 Filtro óleo



1196300
 Junta carburador Nº 1
 Junta carburador Nº 1



JAE-160 - 140006
 Múltiple Admisión y Escape
 Coletor Admissão e Escapamento



1195400 - 140006
 Filtro aceite
 Filtro óleo



1196400
 Junta carburador Nº 2
 Junta carburador Nº 2



JVS-124-30 - 137561
 Junta Tapa Válvula Superior
 Junta Tampa Válvula Superior



1195800 - 1A2099
 Salida caño múltiple
 Saída cano múltiplo



1195000
 Junta carburador Nº 3
 Junta carburador Nº 3



JVL-118-30 - 137053
 Junta Tapa Válvula Lateral
 Junta Tampa Válvula Lateral



1196200 - 1G2342/137544
 Salida calefacción
 Saída aquecimento



1195600 - 1G2149/137543
 Termostato
 Termostato

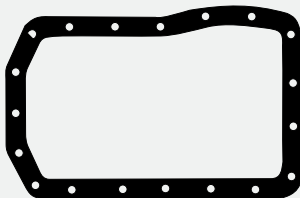

JC-132-30 - 137118
 Junta Cártel
 Junta Carter



1196000 - 11G97/137044
 Tapa placa distribución
 Tampa placa distribuição

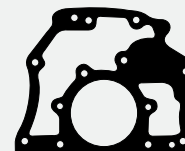

1195900 - 1G2425/137014
 Caja de velocidad
 Caixa de Câmbio



1195300 - 1H353
 Cabecera cárter
 Mancal carter



1195700 - 1G2302/139516
 Bomba de agua
 Bomba de água



1196100 - 11G95/137004
 Tapa distribución
 Tampa distribuição



RT-522Po1
 Jgo. Ret. Guía de Válvulas
 Jogo Retentor da Haste de Válvulas



RT-6692
 Retén Distribución
 Ret. Dianteiro do Virabrequim
 Lx-R 39,69 x 58,98 x 9,75

Productos relacionados no incluidos en el juego. Los mismos pueden ser solicitados por separado.

Produtos relacionados não incluídos no jogo. Podem ser solicitados em separado.

Related products that were not included in the set but can be ordered separately.



1085300 - 12081
 Junta Diferencial
 Junta Diferencial

DESCRIPCIÓN / Descrição / Description

DODGE: D1500 1971/81 - D1800 1975/81
Paikan - GT90 - GT100 1971/...
VOLKSWAGEN: 1500 - 1800 1982/...

MOTOR / Engine	CM ³	HP	Ø PISTON
Hillman	1498	72	86.00
Hillman	1798	110	86.00

Juego Completo de Reparación:

Jogo de Juntas do Motor / Full Set Gasket:

JR-130-15

R

Semi-Juego de Reparación:

Semi-Jogo de Juntas / Semi-Set Gasket:

Juego de Descarbonización:

Jogo de Juntas Superior / Head Set Gasket:

JD-106-15

R

JUNTA CULATA DE CILINDROS	TC-192-15	Ø 88.50mm	1.60mm	1.60mm	1.60mm
Junta de cabeçote	TC-192-18	Ø 88.50mm	2.30mm	2.30mm	2.30mm
Cylinder Head gasket					



JD-106-15

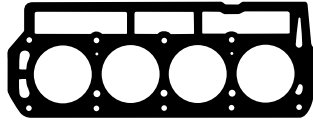

TC-192-15 - 71241047
Junta Culata de Cilindros
Junta Cabeçote



JSA-111 - 71248090
Salida Escape
Saída Escapamento



1023300 - 71241082
Base termostato
Base termostato



JAE-164 - 71241094
Múltiple Admisión y Escape
Coletor Admissão e Escapamento

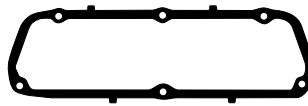

JVS-125-30 - 71244439
Junta Tapa Válvula Superior
Junta Tampa Válvula Superior



RT-511Pol
Juego Retenes Guía de Válvulas
Jogo Retentor da Haste de Válvulas



JC-135-30 - 7124432
Junta Cáster
Junta Carter

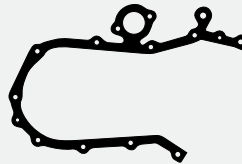

1023800 - 71300122
Tapa distribución
Tampa distribuição



1023700 - 71241043
Bomba de agua
Bomba de água



1023400 - 71235148
Base carburador
Base carburador



1023500 - 71240873
Cuerpo carburador
Corpo carburador



1023600 - 71240978
Bomba de nafta
Bomba de gasolina



2735300 - 71268779
Bancada cigueñal
Pino Virabrequim



1023900 - 71302031
Placa retén
Placa retentor



1121900 - D101
Bomba de aceite
Bomba de óleo



RT-6118Pol
Retén Bancada
Retentor Traseiro do Virabrequim
Lx-Hel 76,20 x 95,25 x 9,27



RT-6104Pol
Retén Distribución
Retentor Dianteiro do Virabrequim
Lx-Hel 44,00 x 63,50 x 9,50

Productos relacionados no incluidos en el juego. Los mismos pueden ser solicitados por separado
Produtos relacionados não incluídos no jogo. Podem ser solicitados em separado / Related products that were not included in the set but can be ordered separately.



BU-134
Bulones para
Culata de Cilindros
Parafusos de Cabeçote



JB-117
Jgo. Carb.
Jgo. Carb.



JB-169
Jgo. Carb.
Jgo. Carb.



JB-185
Jgo. Carb.
Jgo. Carb.



JB-211
Jgo. Carb.
Jgo. Carb.



JV-108
Jgo. Caja Vel.
Jogo Caixa
de Câmbio



1085100 - B4C9DZ4036A
Junta Diferencial
Junta Diferencial
(Dana 30)



1085400 - 71302502
Junta Diferencial
Junta Diferencial

Juego Completo de Reparación:

Jogo de Juntas do Motor / Full Set Gasket:

JR-135-05

DESCRIPCIÓN / Descrição / Description

IKA: Estanciera - Baqueano - Continental
 Manhattan 1955/... - Bergantin Super 1954/67
 Kaiser Carabela - Gladiator (2090610)

MOTOR / Engine	CM ³	HP	Ø PISTON
L226	3705	110	84.14

ILLINOIS

ESTANCIERA / IKA

Semi-Juego de Reparación:

Semi-Jogo de Juntas / Semi-Set Gasket:

Juego de Descarbonización:

Jogo de Juntas Superior / Head Set Gasket:

JUNTA CULATA DE CILINDROS	TC-199-05	Ø 87.00mm	1.80mm	↑ ↓
Junta de cabeçote	TC-199-01	Ø 87.00mm	1.90mm	↑ ↓
Cylinder Head gasket				↑ ↓

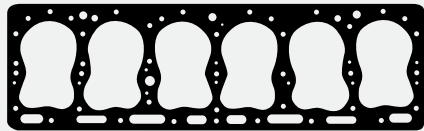

TC-199-05 - 19915/733567
 Junta Culata de Cilindros
 Junta Cabeçote



1024600 - 733612
 Base bomba de agua
 Base bomba de água



1024500 - 733809/711099
 Bomba de agua
 Bomba de água



JAE-168 - 2009066/18615
 Múltiple Admisión y Escape
 Coletor Admissão e Escapamento



JSA-112 - 2073972
 679023/745608/708130
 Salida Escape
 Saída Escapamento



1024900 - 854003
 Vaso bomba de nafta
 Copo bomba de gasolina



JVL-122-30 - 706158
 Junta Tapa Válvula Lateral
 Junta Tampa Válvula Lateral



1117900 - 731046
 Juego bancada
 Jogo mancal



1195500 - 8G619
 Filtro aceite
 Filtro óleo

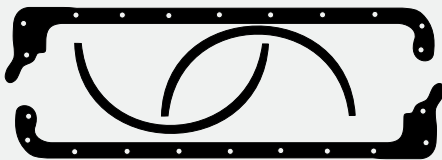

JC-137-30 - 2004800/2016712
 Junta Cáster
 Junta Carter



1024000 - 701290
 Tapa distribución
 Tampa distribuição



1024100 - 711930
 Placa distribución
 Placa distribuição



1025000 - 2000425
 2016726/C3AZ9417C
 Base bomba de nafta
 Base bomba de gasolina



1024300 - 731377
 Salida agua
 Saída água



1024800 - 746043
 Base carburador
 Base carburador



1024700 - 735493
 Caño múltiple
 Tubo coletor



1157000 - 121150
 Entre cuerpo carburador
 Entre corpo carburador



1157200 - 121171
 Tapa carburador
 Tampa carburador



1157100 - 121152
 Tapa carburador
 Tampa carburador



RT-6694Pol
 Retén Distribución
 Retentor Dianteiro
 do Virabrequim
 Lz-R 52,40 x 81,00 x 11,00

Productos relacionados no incluidos en el juego. Los mismos pueden ser solicitados por separado.

Produtos relacionados não incluídos no jogo. Podem ser solicitados em separado.

Related products that were not included in the set but can be ordered separately.



BU-074
 Bulones para Culata de Cilindros
 Parafusos de Cabeçote



JV-109
 Juego Caja Velocidad
 Jogo Caixa de Câmbio



JSA-112-11
 Salida Escape
 Saída Escapamento

DESCRIPCIÓN / Descrição / Description			
FIAT: 600 E.R.S. - 750 1961/80 800 Spider 1962/76 - 770 - 800 - 850 Coupe SEAT: 133 - 850 - 127 1972/78 - Ibiza 82/88 Zastava 750			
MOTOR / Engine	CM ³	HP	Ø PISTON
100D - 170R	767	32	62.00

Juego Completo de Reparación:
 Jogo de Juntas do Motor / Full Set Gasket:

JR-137-15 R

Semi-Juego de Reparación:
 Semi-Jogo de Juntas / Semi-Set Gasket:

Juego de Descarbonización:
 Jogo de Juntas Superior / Head Set Gasket:

JD-104-15 R

JUNTA CULATA DE CILINDROS	TC-208-15	Ø 64.00mm	1.60mm	1.60mm
Junta de cabeçote	TC-208-18	Ø 64.00mm	2.30mm	2.30mm
Cylinder Head gasket				



JD-104-15

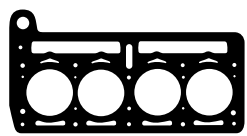

TC-208 - 4064640
 Junta Culata de Cilindros
 Junta Cabeçote



1025400 - 877361/4065247
 Salida agua
 Saída água



JSA-115 - 876075
 Salida Escape
 Saída Escapamento



JAE-176 - 881204/4135158
 Múltiple Admisión y Escape
 Coletor Admissão e Escapamento



JVS-127-30 - 881202/4117850
 Junta Tapa Válvula Superior
 Junta Tampa Válvula Superior

RT-510Pol
 Jgo. Ret. Guía de Válvulas
 Jogo Retentor da Haste de Válvulas

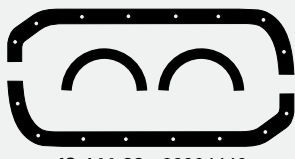

JC-144-30 - 88394446
 Junta Cártér
 Junta Carter



1026700 - 4179113/4081258
 Bomba de nafta
 Bomba de gasolina



1026000 - 883831
 Filtro aceite
 Filtro óleo



1025700 - 4227446
 Bomba de aceite
 Bomba de óleo



1025300 - 877356
 Bomba de agua
 Bomba de água



1026800 - 4220309/97050117
 Tapa termostato
 Tampa termostato



1026100 - 4052518
 Bomba de aceite
 Bomba de óleo



1026200 - 4057986
 Bomba de aceite
 Bomba de óleo



1025500 - 881426/4107391
 Tapa distribución
 Tampa distribuição



1025600 - 881428/4172904
 Tapa posterior
 Tampa posterior



1025900 - 882116
 Salida agua reforma
 Saída água reforma

RT-6487Pol
 Retén Bancada
 Ret. Traseiro do Virabrequim
 Lx-R 64,00 x 80,00 x 8,00

RT-5211Pol
 Retén Distribución
 Retentor Dianteiro do Virabrequim
 A 136-H 42,00 x 56,00 x 7,00

Productos relacionados no incluidos en el juego. Los mismos pueden ser solicitados por separado.
 Produtos relacionados não incluídos no jogo. Podem ser solicitados em separado.
 Related products that were not included in the set but can be ordered separately.

- BU-075**
 Bulones para Culata de Cilindros
 Parafusos de Cabeçote
- JV-110**
 Juego Caja Velocidad
 Jogo Caixa de Câmbio
- JB-122**
 Juego Carburador
 Jogo Carburador
- JB-123**
 Juego Carburador
 Jogo Carburador
- JB-170**
 Juego Carburador
 Jogo Carburador

Juego Completo de Reparación:

Jogo de Juntas do Motor / Full Set Gasket:

JR-283-15**R****Semi-Juego de Reparación:**

Semi-Jogo de Juntas / Semi-Set Gasket:

Juego de Descarbonización:

Jogo de Juntas Superior / Head Set Gasket:

JD-145-15**R**

JUNTA CULATA DE CILINDROS	TC-440-15	∅ 66.00mm	1.60mm	↕
Junta de cabeçote				↕
Cylinder Head gasket				↕

DESCRIPCIÓN / Descrição / Description

FIAT: 133 - 600S - Berlina 1977/82 - Uno 45
850 - 850 Van 1965/76 - 127 Especial 1974/...
SEAT: 133 - 850 - 127 1972/78 - Ibiza 82/88
Fura - Panda - Marbella - Terra

MOTOR / Engine	CM ³	HP	∅ PISTON
100R	843	32	62.50
100G	843	37	65.00
08NCA	843	35	65.00
08/09NCA - 146A	903	40/45	65.00

ILLINOIS

FIAT

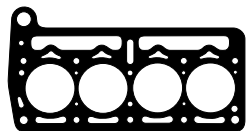
JD-145-15

TC-440-15 - 97051863
Junta Culata de Cilindros
Junta Cabeçote



1025400 - 877361/4065247
Salida agua
Saída água



RT-544Pol
Juego Retenes Guía de Válvulas
Jogo Retentor da Haste de Válvulas



JAE-349 - 4127971
Múltiple Admisión y Escape
Coletor Admissão e Escapamento



JVS-127-30 - 881202/4117850
Junta Tapa Válvula Superior
Junta Tampa Válvula Superior



JSA-115 - 876075
Salida Escape
Saída Escapamento

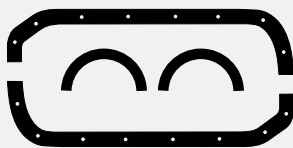

JC-144-30 - 88394446
Junta Carter
Junta Carter



1198700 - 4081258
21011106170
Base bomba de nafta
Base bomba de gasolina



1026000 - 883831
Filtro aceite
Filtro óleo



1198800 - 881452
Superior bomba de aceite
Superior bomba de óleo



1198100 - 4100576
Entre carburador y múltiple
Entre carburador e coletor



1198200 - 4100581
Tapa termostato
Tampa termostato



1026100 - 4052518
Bomba de aceite
Bomba de óleo



1026200 - 4057986
Bomba de aceite
Bomba de óleo



1198600 - 4107391
Tapa distribución
Tampa distribuição



1198300 - 97051581
Tapa bomba de agua
Tampa bomba de água



1198500 - 4101760
Tapa bomba de agua
Tampa bomba de água



1198400 - 4093440
Bomba de agua
Bomba de água



RT-6870Pol
Retén Bancada
Retentor Traseiro do Virabrequim
Lz-R 64,00 x 80,00 x 8,00



RT-6871Pol
Retén Distribución
Retentor Dianteiro do Virabrequim
A 083-R 42,00 x 56,00 x 7,00



1025600 - 881428
4172904
Tapa posterior
Tampa posterior

Productos relacionados no incluidos en el juego. Los mismos pueden ser solicitados por separado.

Produtos relacionados não incluídos no jogo. Podem ser solicitados em separado.

Related products that were not included in the set but can be ordered separately.



JV-131
Juego Caja Velocidad
Jogo Caixa de Câmbio



JB-171
Juego Carburador
Jogo Carburador



DESCRIPCIÓN / Descrição / Description

FIAT: Uno Mille - Palio - Siena 1983/... - Elba Fiorino - Premio

MOTOR / Engine

MOTOR / Engine	CM ³	HP	Ø PISTON
146B4	994	48/61	76.00
146A5	1301	67	76.00
Fiasa	1497	76	76.00

Juego Completo de Reparación:

Jogo de Juntas do Motor / Full Set Gasket:

JR-383-15



Semi-Juego de Reparación:

Semi-Jogo de Juntas / Semi-Set Gasket:

SJ-369



Juego de Descarbonización:

Jogo de Juntas Superior / Head Set Gasket:

JD-383-15



JUNTA CULATA DE CILINDROS

Junta de cabeçote
Cylinder Head gasket

TC-536-15	Ø 77.20mm	1.60mm	±0.05
TC-536-18	Ø 77.20mm	2.30mm	±0.05
	Ø		±0.05
	Ø		±0.05



JD-383-15

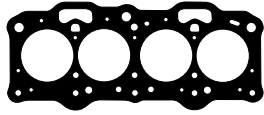

TC-536-15 - 7732330/7702873
Junta Culata de Cilindros
Junta Cabeçote



JSA-205
Salida Escape
Saída Escapamento



1030800 - 4206146/4428157
Base carburador
Base carburador



1179900 - 4249520
Tapa árbol de levas (0,8mm)
Tampa árvore de comando



JAE-341 - 4296119/4398359
Múltiple Admisión y Escape
Coletor Admissão e Escapamento



1122900 - 4325360
Tapa retén aceite
Tampa retentor óleo



1123000 - 4346415
Cuerpo bomba de agua
Corpo bomba de água



RT-508Pol
Juego Retenes Guía de Válvulas
Jogo Retentor da Haste de Válvulas



JVS-243-30 - 4323710
Junta Tapa Válvula Superior
Junta Tampa Válvula Superior



1122800 - 4296113
Tapa cámara agua
Tampa câmara água



1123100 - 4351195
Base termostato
Base termostato



RT-6121Pol
Retén Árbol de Levas
Ret. do Eixo Comando de Válv.
Mx-R 30,00 x 52,00 x 7,00



1122100 - 4109133
Distribución/Distribuição



1194600 - 4143730
Base bomba de nafta
Base bomba de gasolina



1030300 - 4193959
Soporte caño agua
Suporte cano água



1194700 - 4427495/4386839/40
Bomba de nafta (0,4mm)
Bomba de gasolina

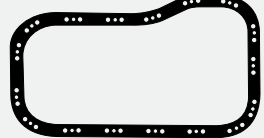

JC-286-30 - 4249510/7669585
Junta Cártier
Junta Carter



1122400 - 4249517
Placa distribución
Placa distribuição



1194500 - 4346834
Tensor de correa
Tensor de correia



1194800 - 4427495/4346839/40
Bomba de nafta (0,8mm)
Bomba de gasolina



1122300 - 4249516
Tapa distribución
Tampa distribuição



1194300 - 4346836/4427495
Colector de aspiración
Coletor aspiração



2735500 - 4184495
Termostato
Termostato



1194900 - 4427495/4346839/40
Bomba de nafta (1,6mm)
Bomba de gasolina



1194400 - 4346833
Tapa block a volante
Tampa bloco ao volante



1123200 - 4386806
Tapa block lado placa
Tampa bloco lado placa



1122600 - 4250500
Cuerpo bomba aceite
Corpo bomba óleo



1123300 - 4434100/4346836
Colector aspiración
Coletor aspiração



RT-8097Pol
Retén Bancada Mz-R
Retentor Traseiro do Virabrequim
70,00 x 85,00 x 8,00



RT-6123Pol
Retén Distribución Mx-R
Retentor Dianteiro do Virabrequim
40,00 x 56,00 x 7,00



1122700 - 4250780
Base bomba de agua
Base bomba de água



1123400 - 4477229/4386808
Tapa block lado volante
Tampa bloco lado volante

Productos relacionados no incluidos en el juego. Los mismos pueden ser solicitados por separado.

Produtos relacionados não incluídos no jogo. Podem ser solicitados em separado.

Related products that were not included in the set but can be ordered separately.



BU-004
Bulones para Culata de Cilindros
Parafusos de Cabeçote



1122500 (0,3mm)
1135200 (0,5mm)
Tapa Árbol de Levas
Tampa Eixo Comando de Válv.



JC-286-23 - 4249510
7669585
Junta Cártier
Junta Carter



JVS-243-25 - 4323710
Junta Tapa Válvula Superior
Junta Tampa Válvula Superior (1mm)



JSA-205-11
Salida Escape
Saída Escapamento

Juego Completo de Reparación:

Jogo de Juntas do Motor / Full Set Gasket:

JR-353-15**Semi-Juego de Reparación:**

Semi-Jogo de Juntas / Semi-Set Gasket:

SJ-353**Juego de Descarbonización:**

Jogo de Juntas Superior / Head Set Gasket:

JD-353-15

JUNTA CULATA DE CILINDROS	TC-536-15	Ø77.20mm	1.60mm	±0.05
Junta de cabeçote	TC-536-18	Ø77.20mm	2.30mm	±0.05
Cylinder Head gasket				

DESCRIPCIÓN / Descrição / Description

FIAT: Palio 1.0 ED/EDX MPI 96 - Uno Mille
Palio 1.5 EL MPI 96 - Siena - Albea - Young

MOTOR / Engine	CM ³	HP	Ø PISTON
ED/EDX MPI Fiasa	994	48/61	76.00
EL MPI	1495	76	76.00

ILLINOIS

FIAT

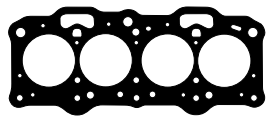
JD-353-15
TC-536-15 - 7732330/7702873
 Junta Culata de Cilindros
 Junta Cabeçote

JSA-118
 Salida Escape
 Saída Escapamento

1140100 - 46440387
 Tapa trasera
 Tampa traseira

1122800 - 4296113
 Tapa cámara agua
 Tampa câmara água

JAE-480 - 46451539
 Múltiple Admisión y Escape
 Coletor Admissão e Escapamento

JAE-481-A - 46435756
 Junta Admisión
 Junta Admissão

1140200 - 46435757
 Base inyección
 Base injeção

1122900 - 4325360
 Tapa retén aceite
 Tampa retentor óleo

JVS-320-25 - 4323710
 Junta Tapa Válvula Superior
 Junta Tampa Válvula Superior

1136800 - 46436930
 Termostato a block
 Termostato ao bloco

1122700 - 4250780
 Base bomba de agua
 Base bomba de água

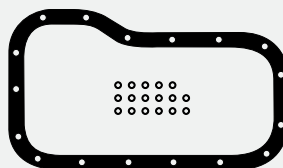
RT-508PoI
 Juego Retenes Guía de Válvulas
 Jogo Retentor da Haste de Válvulas

JC-346-30 - 4249510
 Junta Cáster c/arrandelas
 Junta Carter c/arruelas

1179900 - 4249520
 Tapa árbol de levas
 Tampa árvore de comando (0,8mm)

RT-6121PoI
 Retén Árbol de Levas
 Ret. do Eixo Comando de Válv.
 Mx-R 30,00 x 52,00 x 7,00

1194500 - 4346834
 Tensor de correa
 Tensor de correia

1122300 - 4249516
 Tapa distribución
 Tampa distribuição

1194400 - 4346833
 Tapa block a volante
 Tampa bloco ao volante

1122400 - 4249517
 Placa distribución
 Placa distribuição

1123300 - 4434100/4346836
 Colector aspiración
 Coletor aspiração

1030300 - 4193959
 Soporte caño agua
 Soporte cano água

1122600 - 4250500
 Cuerpo bomba de aceite
 Corpo bomba de óleo

1140300 - 7733577
 Bomba de aceite
 Bomba de óleo

1123200 - 4386806
 Tapa block lado placa
 Tampa bloco lado placa

1123400 - 4477229
 4386808
 Tapa block lado volante
 Tampa bloco lado volante

RT-8097PoI
 Retén Bancada
 Ret. Traseiro do Virabrequim
 Mz-R 70,00 x 85,00 x 8,00

RT-6123PoI
 Retén Distribución
 Ret. Dianteiro do Virabrequim
 Mx-R 40,00 x 56,00 x 7,00

Productos relacionados no incluidos en el juego. Los mismos pueden ser solicitados por separado.

Produtos relacionados não incluídos no jogo. Podem ser solicitados em separado.

Related products that were not included in the set but can be ordered separately.

BU-004
 Bulones para
 Culata de Cilindros
 Parafusos de Cabeçote

1122500 (0,3mm)
1135200 (0,5mm)
 4249520 Tapa Árbol de Levas
 Tampa Eixo Comando de Válvulas

DESCRIPCIÓN / Descrição / Description

FIAT: Uno - Smart - Punto SS 1993/99
Seicento - Cinquecento - Uno 45 - Fire
Panda - Tipo 1989/95 - Palio - Lancia Y10I

MOTOR / Engine	CM ³	HP	Ø PISTON
156A2000/2246	999	30/45	70.00
156C046	1108	49/55	70.00
146C3000	1108	49/55	70.00
176B2000	1108	49/55	70.00

Juego Completo de Reparación:

Jogo de Juntas do Motor / Full Set Gasket:

JR-352-15



Semi-Juego de Reparación:

Semi-Jogo de Juntas / Semi-Set Gasket:

SJ-352



Juego de Descarbonización:

Jogo de Juntas Superior / Head Set Gasket:

JD-352-15



JUNTA CULATA DE CILINDROS	TC-725-15	Ø 72.00mm	1.50mm	
Junta de cabeçote	TC-725-MG	Ø 72.00mm	1.30mm	
Cylinder Head gasket	TC-725-18	Ø 72.00mm	2.30mm	



JD-352-15

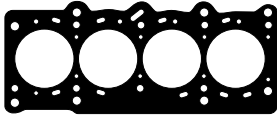

TC-725-15 -
46546120/5970285
7579741/42/7640784 Junta
Culata de Cilindros Junta
Cabeçote



JAE-459-E - 46546134/46404428
Juego Escape
Jogo Escapamento



JAE-484-A
Junta Admisión
Junta Admissão



1022900 - 7604488
Termostato
Termostato



JVS-322-43
Junta Tapa Válvula Superior
Junta Tampa Válvula Superior



RT-6858Pol
Retén Árbol de Levas
Ret. do Eixo Comando de Válvulas
Lz-R 30,00 x 42,00 x 7,00



RT-544Pol
Jgo. Ret. Guía de Vál.
Jogo Retentor da Haste
de Válvulas



1035000
Bancada grande
Virabrequim grande



1034900
Bancada chica
Virabrequim pequeno



1120100
Bomba de agua
Bomba de água

Productos relacionados no incluidos en el juego. Los mismos pueden ser solicitados por separado.

Produtos relacionados não incluídos no jogo. Podem ser solicitados em separado.

Related products that were not included in the set but can be ordered separately.



BU-009
Bulones para
Culata de Cilindros
Parafusos de Cabeçote

Juego Completo de Reparación:

Jogo de Juntas do Motor / Full Set Gasket:

JR-492**Semi-Juego de Reparación:**

Semi-Jogo de Juntas / Semi-Set Gasket:

SJ-492**Juego de Descarbonización:**

Jogo de Juntas Superior / Head Set Gasket:

JD-492**JUNTA CULATA DE CILINDROS**TC-725-15 \varnothing 72.00mm \times 1.50mmTC-725-MG \varnothing 72.00mm \times 1.30mmJunta de cabeçote
Cylinder Head gasketTC-725-18 \varnothing 72.00mm \times 2.30mm

DESCRIPCIÓN / Descrição / Description

FIAT: Uno - Palio - Siena - Punto - Mille Fire
Albea

MOTOR / Engine

CM³

HP

 \varnothing PISTON

Fire 8V MPI 999 55/65 70.00

Fire 8V MPI 1242 73/75 70.80

ILLINOIS

FIAT

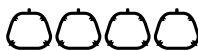
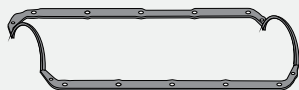
JD-492**TC-725** - 46546120/5970285
7579741/42/7640784
Junta Culata de Cilindros
Junta Cabeçote**JSA-285** - 46465291
Salida Escape
Saída Escapamento**2755300** - 46824135
Sensor de temperatura
Sensor de temperatura**JAE-459-E** - 46546134/46404428
Juego Escape
Jogo Escapamento**JAE-460-A** - 71716583
7082499/13187200
Juego Admisión
Jogo Admissão**2709900** - 46549928
Guarnição
Guarnição**JVS-299-43** - 46748519
Junta Tapa Válvula Superior
Junta Tampa Válvula Superior**1022900** - 7604488
Termostato
Termostato**RT-544Pol**
Juego Retenes Guía de Válvula
Jogo Retedor da Haste
de Válvulas**JC-341-43** - 4249510
Junta Carter
Junta Carter**1022800** - 46552427
Tapa distribución
Tampa distribuição**RT-6858Pol**
Retén Árbol de Levas
Retedor do Eixo Comando
de Válvulas
Lz-R 30,00 x 42,00 x 7,00**RT-9825Pol**
Retén Bomba de Aceite
Retedor Bomba de óleo
A 156-R 27,00 x 37,00 x 7,00**2710000** - 14463580
O'ring 30 x 3,53mm

Productos relacionados no incluidos en el juego. Los mismos pueden ser solicitados por separado.

Produtos relacionados não incluídos no jogo. Podem ser solicitados em separado.

Related products that were not included in the set but can be ordered separately.

**BU-009**
Bulones para
Culata de Cilindros
Parafusos de Cabeçote**RT-9945Vit**
Porta Retén Bancada
Flange Tras. do Virabrequim
A 351-AH 74,00**JSA-285-11**
Salida Escape
Saída Escapamento

DESCRIPCIÓN / Descrição / Description

FIAT: Palio - Siena - Palio Novo - Doblo
 Palio Weekend - Novo Siena - Brava - Bravo
 Stilo 16V 2000/... - Albea
 LANCIA: Ypsilon 2000/...

MOTOR / Engine	CM ³	HP	Ø PISTON
Fire 16V-1714130	999	70	70.00
Fire 16V	1242	80	71.00
188 A5000	1242	60	70.80

Juego Completo de Reparación:

Jogo de Juntas do Motor / Full Set Gasket:

JR-493

R

Semi-Juego de Reparación:

Semi-Jogo de Juntas / Semi-Set Gasket:

SJ-493

R

Juego de Descarbonización:

Jogo de Juntas Superior / Head Set Gasket:

JD-493

R

JUNTA CULATA DE CILINDROS	TC-726-15	Ø 72.00mm	1.50mm	±0.05
Junta de cabeçote	TC-726-MG	Ø 72.00mm	1.30mm	±0.05
Cylinder Head gasket	TC-726-18	Ø 72.00mm	2.30mm	±0.05



JD-493



TC-726 - 46541740
 Junta Culata de Cilindros
 Junta Cabeçote



JSA-286 - 46774747
 Salida Escape
 Saída Escapamento



2710200 - 71716584/7086225
 Sensor temperatura de agua
 (Admisión)
 Sensor de temperatura de água
 (Admissão)



JAE-460-A - 71716583
 7082499/13187200
 Juego Admisión
 Jogo Admissão



JAE-461-E - 46526271
 Junta Escape
 Junta Escapamento



2709900 - 46549928
 Guarnición
 Guarnição

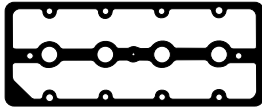

JVS-316-15 - 46513955
 Junta Tapa Válvula Superior
 Junta Tampa Válvula Superior



1022900 - 7604488
 Termostato
 Termostato



RT-581Pol
 Jgo. Retenes Guía de Válvulas
 Jogo Retentor da Haste de Válvulas



JC-342-30 - 46745223
 Junta Cáster
 Junta Carter



1118400 - 46751961
 Junta



RT-8573Pol
 Retén Árbol de Levas
 Ret. do Eixo Comando de Válvulas
 Lx-Hel 40,00 x 55,00 x 8,00



1118500 - 46552317
 Tapa distribución
 Tampa distribuição



2710000 - 14463580
 O'ring 30 x 3,53mm



RT-9825Pol
 Retén Distribución
 Retentor Dianteiro do Virabrequim
 A 156-R 27,00 x 37,00 x 7,00

Productos relacionados no incluidos en el juego. Los mismos pueden ser solicitados por separado.

Produtos relacionados não incluídos no jogo. Podem ser solicitados em separado.

Related products that were not included in the set but can be ordered separately.



BU-053
 Bulones para
 Culata de Cilindros
 Parafusos de Cabeçote



RT-9944Vit
 Porta Retén Bancada
 Flange Traseiro do Virabrequim
 A 350-AH 74,00



JSA-286-11 - 46774747
 Salida Escape
 Saída Escapamento

Juego Completo de Reparación:

Jogo de Juntas do Motor / Full Set Gasket:

JR-593**Semi-Juego de Reparación:**

Semi-Jogo de Juntas / Semi-Set Gasket:

SJ-593**Juego de Descarbonización:**

Jogo de Juntas Superior / Head Set Gasket:

JD-593

JUNTA CULATA DE CILINDROS	TC-448-15	∅ 73.00mm	± 1.50mm	↑ ↓
Junta de cabeçote	TC-448-MG	∅ 73.00mm	± 1.50mm	↑ ↓
Cylinder Head gasket	TC-448-18	∅ 73.00mm	± 2.30mm	↑ ↓

DESCRIPCIÓN / Descrição / Description

FIAT: Palio II/III 2007/13 - Grande Siena Uno Attractive/Way 2011/... - Punto Attractive Idea 2009/... - 500 2007/... - Línea 2007/... Strada III - Fiorino

MOTOR / Engine	CM ³	HP	∅ PISTON
350 A1.000	1242	70/77	72.00
169 A4.000	1368	80/82	72.00
Fire Evo 8V			

ILLINOIS

FIAT



JD-593

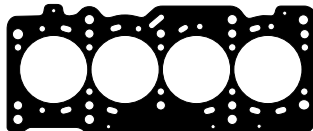

TC-448 - 55190882
Junta Culata de Cilindros
Junta Cabeçote



JSA-285 - 46465291
Salida Escape
Saída Escapamento



1022900 - 7604488
Termostato



JAE-460-A - 71716583
7082499/13187200
Juego Admisión
Jogo Admissão



JAE-459-E - 46546134
46404428/55199355
Juego Escape
Jogo Escapamento



2755300 - 46824135
Sensor de temperatura
Sensor de temperatura



JVS-380-43 - 55222898
Junta Tapa Válvula Superior
Junta Tampa Válvula Superior



2709900 - 46549928
Guarnición
Guarnição



RT-01922J
Juego Retenes Guía Válvulas
Jogo Retentor da Haste de Válvulas

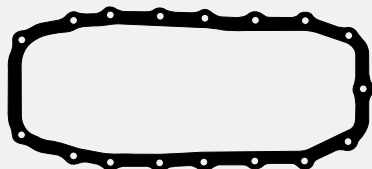

JC-342-30 - 46745223
Junta Carter
Junta Carter



1118500 - 46552317
Tapa distribución
Tampa distribuição



RT-8573Pol
Retén Árbol de Levas
Retentor do Eixo Comando de Válvulas
Lx-Hel 40,00 x 55,00 x 8,00



RT-9825Pol
Retén Distribución
Retentor Dianteiro do Virabrequim
A 156-R 27,00 x 37,00 x 7,00



2710000 - 14463580
O'ring 30 x 3,53mm

Productos relacionados no incluidos en el juego. Los mismos pueden ser solicitados por separado.

Produtos relacionados não incluídos no jogo. Podem ser solicitados em separado.

Related products that were not included in the set but can be ordered separately.



BU-009
Bulones para
Culata de Cilindros
Parafusos de Cabeçote



JSA-285-11 - 46465291
Salida Escape
Saída Escapamento



RT-9944Vit
Porta Retén Bancada
Flange Traseiro do Virabrequim
A 350-AH 74,00

DESCRIPCIÓN / Descrição / Description

FIAT: 147 - Oggi - Panorama - Uno - Elba Premio - Trend - Fiorino (7073000/418)

MOTOR / Engine	CM ³	HP	Ø PISTON
127AB 206	1049	60/70	76.00
127AB 2C	1300	60/70	76.00

Juego Completo de Reparación:

Jogo de Juntas do Motor / Full Set Gasket:

JR-369-15



Semi-Juego de Reparación:

Semi-Jogo de Juntas / Semi-Set Gasket:

SJ-369



Juego de Descarbonización:

Jogo de Juntas Superior / Head Set Gasket:

JD-369-15



JUNTA CULATA DE CILINDROS	TC-504-15	Ø 77.00mm	1.60mm	↑ ↓
Junta de cabeçote		Ø		↑ ↓
Cylinder Head gasket		Ø		↑ ↓



JD-369-15

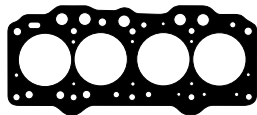

TC-504-15 - 5990020/4387346
Junta Culata de Cilindros
Junta Cabeçote



JSA-205
Salida Escape
Saída Escapamento



1030800 - 4206146
4428157
Base carburador
Base carburador



1179900 - 4249520
Tapa árbol de levas (0,8mm)
Tampa árvore de comando



JAE-341 - 4296119/4398359
Múltiple Admisión y Escape
Coletor Admissão e Escapamento



1122900 - 4325360
Tapa retén aceite
Tampa retentor óleo



1123000 - 4346415
Cuerpo bomba de agua
Corpo bomba de água



RT-508Pol
Juego Retenes Guía de Válvulas
Jogo Retentor da Haste de Válvulas



JVS-243-30 - 4323710
Junta Tapa Válvula Superior
Junta Tampa Válvula Superior



1122800 - 4296113
Tapa cámara agua
Tampa cámara água



1123100 - 4351195
Base termostato
Base termostato



RT-6121Pol
Retén Árbol de Levas
Ret. do Eixo Comando de Válvulas
Mx-R 30,00 x 52,00 x 7,00



1122100 - 4109133
Distribución/Distribuição



1194600 - 4143730
Base bomba de nafta
Base bomba de gasolina



1030300 - 4193959
Soporte caño agua
Soporte cano água



1194700 - 4427495/4386839/40
Bomba de nafta/
Bomba de gasolina (0,4mm)

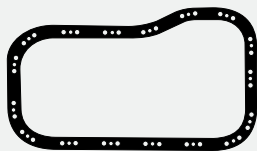

JC-286-30 - 4249510/7669585
Junta Cártier
Junta Carter



1122400 - 4249517
Placa distribución
Placa distribuição



1122300 - 4249516
Tapa distribución
Tampa distribuição



1194300 - 4346836/4427495
Colector de aspiración
Coletor aspiração



1122700 - 4250780
Base bomba de agua
Base bomba de água



1194400 - 4346833
Tapa block a volante
Tampa bloco ao volante



1194500 - 4346834
Tensor de correa
Tensor de correia



1123400 - 4477229/4386808
Tapa block lado volante
Tampa bloco lado volante



1194800 - 4427495/4346839/40
Bomba de nafta
Bomba de gasolina (0,8mm)



1123200 - 4386806
Tapa block lado placa
Tampa bloco lado placa



1122600 - 4250500
Cuerpo bomba de aceite
Corpo bomba de óleo



1123300 - 4434100/4346836
Colector aspiración
Coletor aspiração



1194900 - 4427495
4346839/40
Bomba de nafta
Bomba de gasolina (1,6mm)



2735500 - 4184495
Termostato
Termostato



RT-8097Pol
Retén Bancada
Retentor do Virabrequim
Mz-R 70,00 x 85,00 x 8,00



RT-6123Pol
Retén Distribución
Retentor Dianteiro do Virabrequim
Mx-R 40,00 x 56,00 x 7,00

Productos relacionados no incluidos en el juego. Los mismos pueden ser solicitados por separado.

Produtos relacionados não incluídos no jogo. Podem ser solicitados em separado.

Related products that were not included in the set but can be ordered separately.



BU-004
Bulones para Culata de Cilindros
Parafusos de Cabeçote



1122500 (0,3mm)
1135200 (0,5mm)
Tapa Árbol de Levas
Tampa Árvore de Comando



JC-286-23 - 4249510
7669585
Junta Cártier
Junta Carter

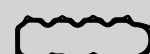

JVS-243-25 - 4323710
Junta Tapa Vál. Sup.
Junta Tampa Válvula Superior (1mm)



JSA-205-11
Salida Escape
Saída Escapamento

Juego Completo de Reparación:

Jogo de Juntas do Motor / Full Set Gasket:

JR-140-15

DESCRIPCIÓN / Descrição / Description

FIAT: 1100/103 1961/64

Semi-Juego de Reparación:

Semi-Jogo de Juntas / Semi-Set Gasket:

Juego de Descarbonización:

Jogo de Juntas Superior / Head Set Gasket:

JUNTA CULATA DE CILINDROS	TC-206-15	∅ 74.00mm	1.60mm	↑ ↓
Junta de cabeçote				↑ ↓
Cylinder Head gasket				↑ ↓

MOTOR / Engine	CM ³	HP	∅ PISTON
	1089	65	68.50

ILLINOIS

FIAT

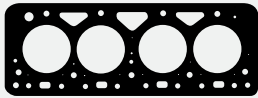

TC-206-15 - 4015455
Junta Culata de Cilindros
Junta Cabeçote



JSA-114 - 860639
Salida Escape
Saída Escapamento



1027300 - 810874
Bomba de aceite
Bomba de óleo



JAE-175 - 4015881
Múltiple Admisión y Escape
Coletor Admissão e Escapamento



1027500 - 853240
Bomba de agua
Bomba de água



1027600 - 854893
Base carburador
Base carburador



JVS-129-30 - 859472
Junta Tapa Válvula Superior
Junta Tampa Válvula Superior



JVL-124-30 - 367188
Junta Tapa Válvula Lateral
Junta Tampa Válvula Lateral



1027400 - 853238/367185
Salida agua
Saída água

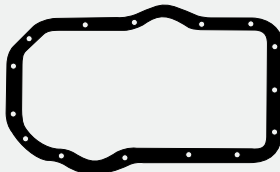

JC-142-30 - 869695
Junta Carter
Junta Carter



1027100 - 367198
Placa distribución
Placa distribuição



1027200 - 367200
Tapa distribución
Tampa distribuição



RT-6487Pol
Retén Bancada
Retentor Traseiro do Virabrequim
Lx-R 64,00 x 80,00 x 8,00



RT-5208
Retén Distribución
Retentor Dianteiro do Virabrequim
Lz-Hel 40,00 x 60,00 x 10,00

Productos relacionados no incluidos en el juego. Los mismos pueden ser solicitados por separado.

Produtos relacionados não incluídos no jogo. Podem ser solicitados em separado.

Related products that were not included in the set but can be ordered separately.

DESCRIPCIÓN / Descrição / Description

FIAT: 128 - 147 - Spazio - Brio - Ritmo 60
Europa C 1970/81 - Strada 60 1971/...
(1041169)

MOTOR / Engine	CM ³	HP	Ø PISTON
128A	1116	55/60	80.00

Juego Completo de Reparación:

Jogo de Juntas do Motor / Full Set Gasket:

JR-138-15

R

Semi-Juego de Reparación:

Semi-Jogo de Juntas / Semi-Set Gasket:

Juego de Descarbonización:

Jogo de Juntas Superior / Head Set Gasket:

JD-108-15

R

JUNTA CULATA DE CILINDROS	TC-209-15	Ø 82.00mm	1.60mm
Junta de cabeçote	TC-209-18	Ø 82.00mm	2.30mm
Cylinder Head gasket			

JD-108-15

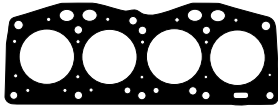

TC-209-15 - 4179084/4321213
Junta Culata de Cilindros
Junta Cabeçote



1030200 - 4179183
Tapa termostato
Tampa termostato



1030400 - 4194902
Brida caño calefactor
Flange cano aquecedor



1030100 - 4179155
Base bomba de agua
Base bomba de água



JAE-180 - 4195133/4309031
Múltiple Admisión y Escape
Coletor Admissão e Escapamento



1030800 - 4206146/4428157
Base carburador
Base carburador



1135300 - 4179117
Tapa árbol de levas
Tampa eixo Comando de válvula (0,8mm)



RT-508Pol
Juego Retenes Guía de Válvulas
Jogo Retentor da Haste de Válvulas



JVS-132-30 - 4195130
97052381/4300225
Junta Tapa Válvula Superior
Junta Tampa Válvula Superior



JVL-126-25 - 4217916/97051650
Junta Tapa Válvula Lateral
Junta Tampa Válvula Lateral (1mm)



1030600 - 4198159
97052380
Base termostato
Base termostato



RT-6121Pol
Retén Árbol de Levas Mx-R
Ret. do Eixo Comando de Válv.
30,00 x 52,00 x 7,00

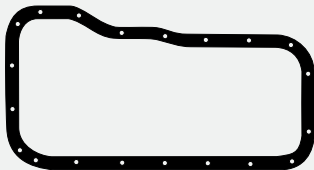

JC-147-30 - 4179038
Junta Carter
Junta Carter



1026700 - 4179113/4081258
Bomba de nafta
Bomba de gasolina



1138800
Base filtro de aceite
Base filtro de óleo



1029800 - 4179138
Bomba de aceite
Bomba de óleo



1029600 - 4179114
Bomba de nafta a block
Bomba de gasolina ao bloco (0,5mm)



1094600 - 4205663
Bomba de nafta a block
Bomba de gasolina ao bloco (0,8mm)



1094700 - 4205664
Bomba de nafta a block
Bomba de gasolina ao bloco (1,5mm)



1139000 - 7770023
Bomba de agua
Bomba de água



1030300 - 4193959
Soporte caño agua
Soporte cano água



1029200 - 4158100
Descarga gases
Retorno gases



1030500 - 4195119
7737204
Porta retén distribución
Flange dianteiro do virabrequim



RT-6123Pol
Retén Distribución
Retentor Dianteiro do Virabrequim
Mx-R 40,00 x 56,00 x 7,00



1029900 - 4179148
Caño bomba de aceite
Tubo bomba óleo



1029300 - 4179043
7737203
Tapa distribución
Tampa distriuição



1030000 - 4179154
97052378
Bomba de agua
Bomba de água



1029400 - 4179044
4302267
Porta retén bancada
Flange traseiro do virabrequim



RT-6487Pol
Retén Bancada
Ret. Traseiro do Virabrequim
Lx-R 64,00 x 80,00 x 8,00

Productos relacionados no incluidos en el juego. Los mismos pueden ser solicitados por separado
Produtos relacionados não incluídos no jogo. Podem ser solicitados em separado / Related products that were not included in the set but can be ordered separately.



BU-529
Bulones para Culata de Cilindros
Parafusos de cabeçote



JSA-233-21
JSA-233-22
Salida Escape
Saída Escape



JAE-180-09
JAE-180-11
JAE-280
Múltiple Admisión y Escape
Coletor Admissão e Escapamento



1029700 - (0,3mm)
1135100 - (0,5mm)
Tapa Árbol de Levas
Tampa Eixo Comando de Válv.



JC-147-23
Junta Carter
Junta Carter

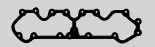

JVL-126-28 - (0,2mm)
JVL-126-29 - (0,3mm)
JVL-126-24 - (0,5mm)
JVL-126-34 - (0,8mm)
Tapa Válvula Lateral
Tampa Válvula Lateral



JSA-217
Arandela Suplemento
Arruela Suplemento



JVS-132-25
Tapa Válvula Superior
Tampa Vál. Superior



JB-131
Jgo. Carb.
Jogo Carb.



JV-112
Jgo. Caja Vel.
Jogo Caixa de Câmbio

Juego Completo de Reparación:

Jogo de Juntas do Motor / Full Set Gasket:

R

Semi-Juego de Reparación:

Semi-Jogo de Juntas / Semi-Set Gasket:

SJ-564

R

Juego de Descarbonización:

Jogo de Juntas Superior / Head Set Gasket:

JD-564-ST

R

JUNTA CULATA DE CILINDROS	TC-805-20 0M	∅ 70.50mm	∓ 0.70mm	∓
Junta de cabeçote	TC-805-20 1M	∅ 70.50mm	∓ 0.80mm	∓
Cylinder Head gasket	TC-805-20 2M	∅ 70.50mm	∓ 0.90mm	∓

DESCRIPCIÓN / Descrição / Description

DIESEL

FIAT: Palio JTD Punto ELX JTD 2003/...
Strada Trekking III JTD 2010/...

MOTOR / Engine	CM ³	HP	∅ PISTON
188 A9.000 (DOHC) 16V	1248	70	69.60

ILLINOIS

FIAT



JD-564-ST

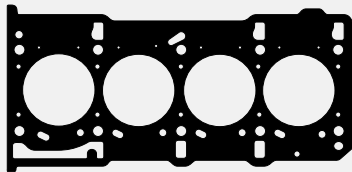

TC-805-20 0M - 55278854/55209070
TC-805-20 1M - 55278855/55209071
TC-805-20 2M - 55278856/55209072
Junta Culata de Cilindros/Junta Cabeçote



1400100
Separador Block
Separador bloco



JSA-337
Salida Escape
Saída Escapamento



1400200 - 73502578
Acople electroválvula
Acoplamento eletroválvula



JAE-622-E - 73500058
Junta Escape
Junta Escapamento



JAE-621-A - 73501362
Junta Admisión
Junta Admissão



1400300
Acople turbo
Acoplamento turbo



1400400
Junta

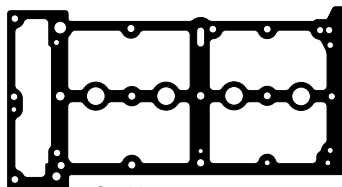

JVS-400-15 - 73500063
Junta Tapa Válvula Superior
Junta Tampa Válvula Superior



1400500
Junta

2754200
O'ring 21 x 1,5mm

2768400
O'ring 45,69 x 2,62mm



2732700 - 71732845
Junta inspección
Junta inspeção

2632800
Arandela 10 x 18 x 1mm
Arruela (Aluminio)

2707000
O'ring 15,64 x 2,62mm

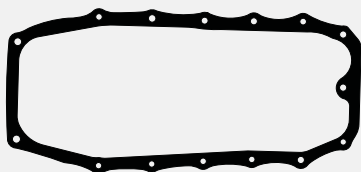

JC-405-26
Junta Cártér
Junta Carter



1400600
Base turbo

2707200
O'ring 40,8 x 3,53mm

RT-890Vit
Juego Retenes Guía de Válvulas
Jogo Retedor da Haste de Válvulas

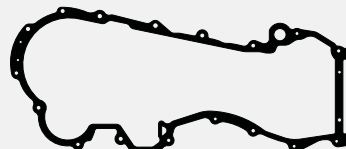

1400900 - 55265148/55186663
Tapa Distribución
Tampa Distribuição



1400700
Junta



1400800
Acople turbo
Acoplamento turbo

2613000
Arandela 10 x 16 x 1mm
Arruela (Aluminio)



2728700 - 55209071
Arandela 66,5 x 70,5 x 3mm
Bomba de agua / Bomba de água



1401000
Junta

2738000 - 71740366
Bomba de aceite
Bomba de óleo



2739500 - 73501332
Base radiador de aceite
Base radiador de óleo



1401100
Junta

RT-2970XTef
Retén Bancada
Retentor Traseiro do Virabrequim
78,00 x 100,00 x 9,00

RT-2971Vit
Retén Distribución
Retentor Dianteiro do Virabrequim
40,00 x 52,00 x 7,00

Productos relacionados no incluidos en el juego. Los mismos pueden ser solicitados por separado.

Produtos relacionados não incluídos no jogo. Podem ser solicitados em separado.

Related products that were not included in the set but can be ordered separately.

DESCRIPCIÓN / Descrição / Description

FIAT: 128 1971/81 - Ritmo - Spazio - Strada 78/85
 Europa - 147 - Fiorino - Uno 70 - Duna - Regatta
LANCIA: Delta - Prisma 1978/83 (1041194)

MOTOR / Engine	CM ³	HP	Ø PISTON
128A1	1290	73	86.40
138B2	1301	68/70	86.40
831B	1301	75/80	86.40
138A/A2/A4	1498	75/85	86.40

Juego Completo de Reparación:

Jogo de Juntas do Motor / Full Set Gasket:

JR-230-15

R

Semi-Juego de Reparación:

Semi-Jogo de Juntas / Semi-Set Gasket:

Juego de Descarbonización:

Jogo de Juntas Superior / Head Set Gasket:

JD-109-15

R

JUNTA CULATA DE CILINDROS	TC-405-15	Ø 87.70mm	1.60mm	±0.05
Junta de cabeçote	TC-405-18	Ø 87.70mm	2.30mm	±0.05
Cylinder Head gasket				



JD-109-15

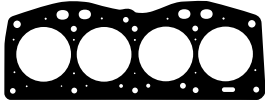

TC-405-15 - 4309957
 5957865/4444452
 Junta Culata de Cilindros
 Junta Cabeçote



JAE-180 - 4195133/4309031
 Múltiple Admisión y Escape
 Coletor Admissão e Escapamento



JVS-132-30 - 4195130
 97052381/4300225
 Junta Tapa Válvula Superior
 Junta Tampa Válvula Superior

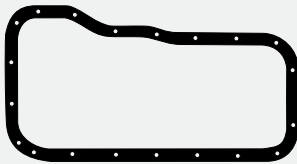

JC-147-30 - 4179038
 Junta Carter
 Junta Carter



1029300 - 4179043
 7737203
 Tapa distribución
 Tampa distribuição



1029800 - 4179138
 Bomba de aceite
 Bomba óleo



1026700 - 4179113
 4081258
 Bomba de nafta
 Bomba gasolina



1030500 - 4195119
 7737204
 Porta retén distribución
 Flange Dianteiro do Virabrequim



1131500 - 4218080
 Tapa árbol de levas trasero
 Tampa eixo comando traseira



1029400 - 4179044
 4302267
 Porta retén bancada
 Flange Traseiro do Virabrequim



1030400 - 4194902
 Brida caño calefactor
 Flange cano aquecedor



1135300 - 4179117
 Tapa árbol de levas (0,8mm)
 Tampa eixo comando de válvulas



JVL-126-25 - 4217916/97051650
 Junta Tapa Válvula Lateral
 Junta Tampa Válvula Lateral (1mm)



1030600 - 4198159/97052380
 Base termostato
 Base termostato



1030100 - 4179155
 Base bomba de agua
 Base bomba de água



1030200 - 4179183
 Tapa termostato
 Tampa termostato



1030800 - 4206146/4428157
 Base carburador
 Base carburador



RT-508PoI
 Juego Retenes
 Guia de Válvulas
 Jogo Retentor da Haste de Válvulas



RT-6121PoI
 Retén Arbol de Levas
 Retentor do Eixo Comando de Válvulas
 Mx-R 30,00 x 52,00 x 7,00



1030300 - 4193959
 Soporte caño agua
 Soporte cano de água



1139000 - 7770023
 Bomba de agua
 Bomba de água



1029600 - 4179114
 Bomba de nafta a block (1,5mm)
 Bomba de gasolina ao bloco



1138900 - 4230783
 Bomba de aceite tubo escape
 Bomba óleo tubo escape



1138800
 Base filtro aceite
 Base filtro óleo



1094700 - 4205664
 Bomba de nafta a block (1,5mm)
 Bomba de gasolina ao bloco



1029900 - 4179148
 Caño bomba de aceite
 Tubo bomba óleo



1029200 - 4158100
 Descarga gases
 Saída de gases



1094600 - 4205663
 Bomba de nafta a block (0,8mm)
 Bomba de gasolina ao bloco



1030000 - 4179154
 97052378
 Bomba de agua
 Bomba de água



1131600 - 4218077
 Tapa árbol de levas distribución
 Tampa eixo comando distribuição



RT-6487PoI
 Retén Bancada
 Retentor Traseiro do Virabrequim
 Lx-R 64,00 x 80,00 x 8,00



RT-6123PoI
 Retén distribución
 Retentor Dianteiro do Virabrequim
 Mx-R 40,00 x 56,00 x 7,00

Productos relacionados no incluidos en el juego. Los mismos pueden ser solicitados por separado

Produtos relacionados não incluídos no jogo. Podem ser solicitados em separado / Related products that were not included in the set but can be ordered separately.

BU-529
 Bulones para Culata de Cilindros
 Parafusos de cabeçote

JVS-132-25
 Tapa Válvula Superior
 Tampa Vál. Superior

JAE-180-09
JAE-180-11
 Múltiple Admisión y Escape
 Coletor Admissão e Escapamento

JAE-280
 Múltiple Admisión y Escape
 Coletor Admissão e Escapamento

JC-147-23
 Junta Carter
 Junta Carter

JV-112
 Jgo. Caja Vel.
 Jogo Caixa de Câmbio

JB-131
 Jgo. Carb.
 Jogo Carb.

JB-215
 Jgo. Carb.
 Jogo Carb.

JB-246
 Jgo. Carb.
 Jogo Carb.



JSA-217
 Arandela Suplemento
 Arruela Suplemento



JVL-126-28 - (0,2mm)
JVL-126-29 - (0,3mm)
JVL-126-24 - (0,5mm)
JVL-126-34 - (0,8mm)
 Junta Tapa Válvula Lateral
 Tampa Válvula Lateral



1029700 - (0,3mm)
1135100 - (0,5mm)
 Tapa Árbol de Levas
 Tampa árvore de comando



JSA-233-21
JSA-233-22
 Salida Escape
 Saída Escape



JV-134
 Jgo. Caja Vel.
 Jogo Caixa de Câmbio



JB-168
 Jgo. Carb.
 Jogo Carb



JB-181
 Jgo. Carb.
 Jogo Carb



JB-234
 Jgo. Carb.
 Jogo Carb



JB-187
 Jgo. Carb.
 Jogo Carb

Juego Completo de Reparación:

Jogo de Juntas do Motor / Full Set Gasket:

Semi-Juego de Reparación:

Semi-Jogo de Juntas / Semi-Set Gasket:

Juego de Descarbonización:

Jogo de Juntas Superior / Head Set Gasket:

JUNTA CULATA DE CILINDROS	TC-608-20 0M	∅ 77.00mm	1.65mm	... a 0,84mm
Junta de cabeçote	TC-608-20 1M	∅ 77.00mm	1.85mm	de 0,85 a 1,05mm
Cylinder Head gasket	TC-608-20 2M	∅ 77.00mm	1.95mm	de 1,06 a 1,25mm
	TC-608-20 3M	∅ 77.00mm	2.10mm	de 1,26mm...
	TC-608-20 4M	∅ 77.00mm	2.40mm	

DESCRIPCIÓN / Descrição / Description

DIESEL

FIAT: 147 - Duna - Fiorino - Spazio - A992
Uno 1985/...

MOTOR / Engine	CM ³	HP	∅ PISTON
4TD - 146B	1301	45	76.10

ILLINOIS

FIAT

MENÜ



TC-608-20 0M - 4467996
TC-608-20 1M - 4467997
TC-608-20 2M - 4467998
TC-608-20 3M
TC-608-20 4M
Junta Culata de Cilindros
Junta Cabeçote

JD-138-ST



2735500 - 4184495
Termostato
Termostato



1123100 - 4351195
Base termostato
Base termostato



2627000
Arandela parallama acero
Arruela bico injetor



1122100 - 4109133
Distribución
Distribuição



1122900 - 4325360
Tapa retén aceite
Tampa retentor óleo



1179900 - 4249520
Tapa árbol de levas (0,8mm)
Tampa árvore de comando



JAE-341 - 4296119/4398359
Múltiple Admisión y Escape
Coletor Admissão e Escapamento



JSA-205
Salida Escape
Saída Escapamento



1122800 - 4296113
Tapa cámara de agua
Tampa câmara de água



RT-508Pol
Juego Retenes Guía de Válvulas
Jogo Retentor da Haste de Válvulas



JVS-238-25 - 4424154
Junta Tapa Válvula Superior
Junta Tampa Válvula Superior



1123000 - 4346415
Cuerpo bomba de agua
Corpo bomba de água



1123500 - 5948368
Tapa bomba de agua
Tampa bomba de água



RT-6121Pol
Retén Árbol de Levas
Retentor do Eixo Comando de Válv.
Mx-R 30,00 x 52,00 x 7,00

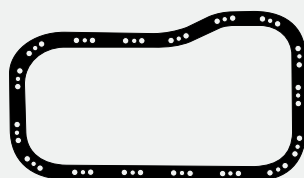

JC-286-30 - 4249510/7669585
Junta Cáster
Junta Carter



1122400 - 4249517
Placa distribución
Placa distribuição



1122300 - 4249516
Tapa distribución
Tampa distribuição



1123200 - 4386806
Tapa block lado placa
Tampa bloco lado placa



1122600 - 4250500
Cuerpo bomba de aceite
Corpo bomba de óleo



1030300 - 4193959
Soporte caño agua
Suporte cano água



1122700 - 4250780
Base bomba de agua
Base bomba de água



1123400 - 4477229/4386808
Tapa block lado volante
Tampa bloco lado volante



1123300 - 4434100
4346836
Colector aspiración
Coletor aspiração



RT-8097Pol
Retén Bancada Mz-R
Ret. Traseiro do Virabrequim
70,00 x 85,00 x 8,00



RT-6123Pol
Retén Distribución Mx-R
Ret. Dianteiro do Virabrequim
40,00 x 56,00 x 7,00

Productos relacionados no incluidos en el juego. Los mismos pueden ser solicitados por separado.

Produtos relacionados não incluídos no jogo. Podem ser solicitados em separado.

Related products that were not included in the set but can be ordered separately.



BU-004
Bulones para
Culata de Cilindros
Parafusos de Cabeçote



1122500 (0,3mm)
1135200 (0,5mm)
4249520 Tapa Árbol de Levas
Tampa Comando de Válvulas



JC-286-23 - 4249510
7669585
Junta Cáster
Junta Carter



JSA-205-11
Salida Escape
Saída Escapamento

DESCRIPCIÓN / Descrição / Description			
FIAT: Mobi Drive 2017/... - Argo Drive 2017/... Cronos Drive 2017/... - Uno Way			
MOTOR / Engine	CM ³	HP	Ø PISTON
Firefly GSE N4	1332	99	70.00

Juego Completo de Reparación: Jogo de Juntas do Motor / Full Set Gasket:	JR-806-11	R		
Semi-Juego de Reparación: Semi-Jogo de Juntas / Semi-Set Gasket:				
Juego de Descarbonización: Jogo de Juntas Superior / Head Set Gasket:				
JUNTA CULATA DE CILINDROS	TC-792-11	Ø 71.00mm	0.80mm	↕
Junta de cabeçote				↕
Cylinder Head gasket				↕

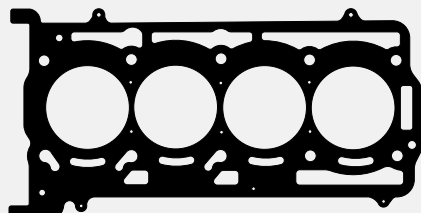

TC-792-11 - 55268170
Junta Culata de Cilindros
Junta Cabeçote



Juego Admisión
Jogo Admissão



Junta Lateral Admisión
Junta Lateral Admissão

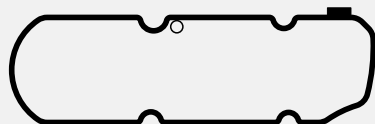

Junta Tapa Válvula Superior
Junta Tampa Válvula Superior



Juego Escape
Jogo Escapamento



Junta

Juego Retenes Guía de Válvulas
Jogo Retentor da Haste de Válvulas

Retén Distribución
Retentor Dianteiro do Virabrequim



Productos relacionados no incluidos en el juego. Los mismos pueden ser solicitados por separado.
Produtos relacionados não incluídos no jogo. Podem ser solicitados em separado.
Related products that were not included in the set but can be ordered separately.

Juego Completo de Reparación:

Jogo de Juntas do Motor / Full Set Gasket:

JR-496**R****Semi-Juego de Reparación:**

Semi-Jogo de Juntas / Semi-Set Gasket:

SJ-496**R****Juego de Descarbonización:**

Jogo de Juntas Superior / Head Set Gasket:

JD-496**R**

JUNTA CULATA DE CILINDROS	TC-448-15	∅ 73.50mm	1.50mm	↑ ↓
	TC-448-MG	∅ 73.50mm	1.50mm	↑ ↓
Junta de cabeçote	TC-448-18	∅ 73.50mm	2.30mm	↑ ↓
Cylinder Head gasket		∅		↑ ↓

DESCRIPCIÓN / Descrição / Description

FIAT: Palio - Siena - Strada

MOTOR / Engine	CM ³	HP	∅ PISTON
Fire 8V	1368	80/81	1.50mm

ILLINOIS

FIAT

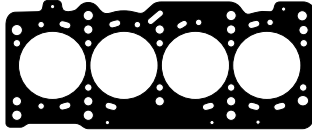
JD-496

TC-448 - 55190882
Junta Culata de Cilindros
Junta Cabeçote



JAE-460-A - 71716583
7082499/13187200
Juego Admisión
Jogo Admissão

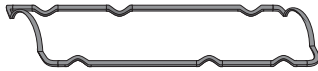

JVS-299-43 - 46748519
Junta Tapa Válvula Superior
Junta Tampa Válvula Superior

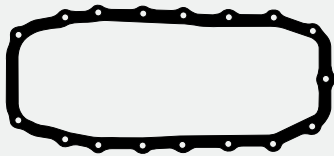

JC-342-30 - 46745223
Junta Cártel
Junta Carter

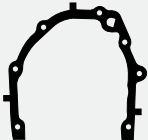

1118500 - 46552317
Tapa distribución
Tampa distribuição



JSA-285 - 46465291
Salida Escape
Saída Escapamento

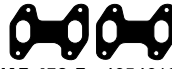

JAE-459-E - 46546134
46404428/55199355
Juego Escape
Jogo Escapamento



2709900 - 46549928
Guarnición
Guarnição



1022900 - 7604488
Termostato
Termostato



2755300 - 46824135
Sensor de temperatura
Sensor de temperatura



2710000 - 14463580
O'ring 30 x 3,53mm



RT-01922J
Juego Ret. Guía de Vál.
Jogo Retentor da
Haste de Válvulas



RT-6858Pol
Retén Árbol de Levas
Retentor do Eixo
Comando de Válvulas
Lz-R 30,00 x 42,00 x 7,00



RT-9825Pol
Retén Distribución
Retentor Dianteiro
do Virabrequim
A 156-R 27,00 x 37,00 x 7,00

Productos relacionados no incluidos en el juego. Los mismos pueden ser solicitados por separado.

Produtos relacionados não incluídos no jogo. Podem ser solicitados em separado.

Related products that were not included in the set but can be ordered separately.



BU-009
Bulones para
Culata de Cilindros
Parafusos de Cabeçote



JSA-285-11 - 46465291
Salida Escape
Saída Escapamento



RT-9944Vit
Porta Retén Bancada
Porta Retentor Mancal
A 350-AH 74,00

DESCRIPCIÓN / Descrição / Description

FIAT: Spazio - Duna - Tipo - Vivace - Palio
Siena 1988/91 - Uno - Fiorino 1993/95
Tempra (7604403)

MOTOR / Engine	CM ³	HP	Ø PISTON
160A1	1372	71	80.50
146C1/5	1372	67/72	80.50
159A2	1372	78	80.50

Juego Completo de Reparación:

Jogo de Juntas do Motor / Full Set Gasket:

JR-340-15



Semi-Juego de Reparación:

Semi-Jogo de Juntas / Semi-Set Gasket:

SJ-340



Juego de Descarbonización:

Jogo de Juntas Superior / Head Set Gasket:

JD-135-15



JUNTA CULATA DE CILINDROS	TC-534-15	Ø 82.00mm	1.60mm	1.60mm
Junta de cabeçote	TC-534-18	Ø 82.00mm	2.30mm	2.30mm
Cylinder Head gasket				

JD-135-15

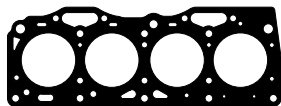

TC-534-15 - 7604403
Junta Culata de Cilindros
Junta Cabeçote



JSA-188-11 - 4309031
Salida Escape
Saída Escapamento



1187400
Base carburador



1187500
Base carburador



1187600
Base termostato



JAE-348 - 7665722/7772495
Múltiple Admisión y Escape
Coletor Admissão e Escapamento



JVS-244-30 - 7554851
Junta Tapa Válvula Superior
Junta Tampa Válvula Superior



1030800 - 4206146/4428157
Base carburador



RT-508Pol
Juego Retenes Guía de Válv.
Jogo Retentor da Haste de Válvulas



JVL-168-24 - 7784728
Junta Tapa Válvula Lateral
Junta Tampa Válvula Lateral (0,5mm)



1135300 - 4179117
Tapa árbol de levas (0,8mm)
Tampa eixo comando de válvulas



1127800 - 46584559/7615049
Termostato
Termostato



RT-6121Pol
Retén Árbol de Levas
Ret. Eixo Comando de Válv.
Mx-R 30,00 x 52,00 x 7,00

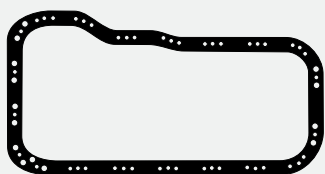

JC-292-30 - 50002911
Junta Cártér
Junta Carter



1030300 - 4193959
Soporte caño agua
Suporte cano água



1138900 - 4230783
Bomba de aceite tubo escape
Bomba de óleo tubo escapamento



1029900 - 4179148
Caño bomba de aceite
Tubo bomba óleo



1029300 - 4179043/7737203
Tapa distribución
Tampa distribuição



1127600 - 4302267/7737202
Porta retén bancada
Flange traseiro do virabrequim



1127500 - 4254031/7575660
Tapa block
Tampa bloco



1029200 - 4158100
Descarga gases
Retorno gases



1029800 - 4179138
Bomba de aceite
Bomba de óleo



1030500 - 4195119/7737204
Porta retén distribución
Flange dianteiro do Virabrequim



1199500 - 7668667/7597760
Tapa inspección
Tampa inspeção



1127700 - 4396562/5937811
Tapa block
Tampa bloco



1122100 - 4109133
Distribución
Distribuição



1030400 - 4194902
Brida caño calefactor
Flange cano aquecedor



1094600 - 4205663
Bomba de nafta a block (0,8mm)
Bomba de gasolina ao bloco



1094700 - 4205664
Bomba de nafta a block (1,5mm)
Bomba de gasolina ao bloco



1029600 - 4179114
Bomba de nafta a block (0,5mm)
Bomba de gasolina ao bloco



1026700 - 4179113
4081258
Bomba de nafta
Bomba de gasolina



1030000 - 4179154
97052378
Bomba de agua
Bomba de água



1030100 - 4179155
Base bomba de agua
Base bomba de água



RT-6487Pol
Retén Bancada
Retentor Traseiro do Virabrequim
Lx-R 64,00 x 80,00 x 8,00



RT-6123Pol
Retén Distribución
Ret. Dianteiro do Virabrequim
Mx-R 40,00 x 56,00 x 7,00

Productos relacionados no incluidos en el juego. Los mismos pueden ser solicitados por separado

Produtos relacionados não incluídos no jogo. Podem ser solicitados em separado / Related products that were not included in the set but can be ordered separately.



BU-006
Bulones para Culata de Cilindros
Parafusos de Cabeçote



JV-134
Juego Caja Velocidad
Jogo Caixa Velocidade



JB-206
Juego Carburador
Jogo Carburador



JVL-162-24 - (0,5mm)
JVL-162-28 - (0,2mm)
JVL-162-29 - (0,3mm)
JVL-162-34 - (0,8mm)
Junta Tapa Válvula Lateral
Junta Tampa Válvula Lateral



JVL-168-28 - (0,2mm)
JVL-168-29 - (0,3mm)
JVL-168-34 - (0,8mm)
Junta Tapa Válvula Lateral
Junta Tampa Válvula Lateral



JAE-348-09 - 766572/7772495
Múltiple Admisión y Escape
Coletor Admissão e Escapamento



1029700 - (0,3mm)
1135100 - (0,5mm)
Tapa Árbol de Levas
Tampa Árvore de Comando



JSA-188-17
Salida Escape
Saída Escapamento



JVS-244-23
Junta Tapa Vál. Sup.
Junta Tampa Válvula Superior



JC-292-23
Junta Cártér
Junta Carter

Juego Completo de Reparación:

Jogo de Juntas do Motor / Full Set Gasket:

JR-141-15**R****Semi-Juego de Reparación:**

Semi-Jogo de Juntas / Semi-Set Gasket:

Juego de Descarbonización:

Jogo de Juntas Superior / Head Set Gasket:

JD-102-15**R**

JUNTA CULATA DE CILINDROS	TC-211-15	∅ 79.00mm	1.60mm	↑ ↓
	TC-211-18	∅ 79.00mm	2.30mm	↑ ↓
Junta de cabeçote		∅	↑ ↓	↑ ↓
Cylinder Head gasket		∅	↑ ↓	↑ ↓

DESCRIPCIÓN / Descrição / Description

FIAT: 1500 Berlina - Multicarga 1963/72
Familiar - 1600 Berlina - Coupe 1969/72
SEAT: 1500 1963/71

MOTOR / Engine	CM ³	HP	∅ PISTON
115 C/BT.038	1481	72	77.00
115 C.2038/20	1600	76	78.00

ILLINOIS

FIAT

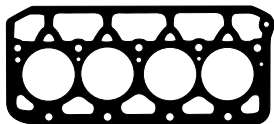
**JD-102-15**

TC-211-15 - 4056553
Junta Culata de Cilindros
Junta Cabeçote



JSA-116 - 4061096
Salida Escape
Saída Escapamento



1028900 - 4089702
Salida agua
Saída água



JAE-178-A - 40866977
Juego Admisión
Jogo Admissão (1500)



JAE-179-A - 412766570
Juego Admisión
Jogo Admissão (1600)



JAE-177-E - 4088354
Junta Escape
Junta Escapamento



JVS-131-30 - 4027732
Junta Tapa Válvula Superior
Junta Tampa Válvula Superior



1028300 - 4025778
Termostato
Termostato



RT-510Pol
Juego Retenes Guía de Válvulas
Jogo Retenedor da Haste de Válvulas

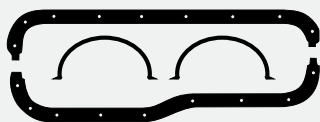

JC-146-30 - 4056384
Junta Carter
Junta Carter



1027800 - 4025572
Distribución anterior
Distribuição anterior



1027900 - 4025574
Distribución posterior
Distribuição posterior



1028100 - 4025775
Tapa bomba de agua
Tampa bomba de água



1028400 - 4026063
Brida caño aceite
Flange cano óleo



1028200 - 4025776
Cuerpo bomba de agua
Corpo bomba de água



1028800 - 4081258
Bomba de combustible
Bomba de gasolina



1028500 - 4026077
Bomba de aceite
Bomba de óleo



1028000 - 4025578
Tubo ventilación
Tubo ventilação



RT-5217Pol
Retén Bancada
Ret. Traseiro do Virabrequim
A 079-R 80,00 x 100,00 x 10,00



RT-5213Pol
Retén Distribución
Ret. Dianteiro do Virabrequim
079-Hel 45,00 x 65,00 x 10,00

Productos relacionados no incluidos en el juego. Los mismos pueden ser solicitados por separado

Produtos relacionados não incluídos no jogo. Podem ser solicitados em separado / Related products that were not included in the set but can be ordered separately.



1085700 - 4059702
Junta Tapa Diferencial
Junta Tampa Diferencial



JV-111
Jgo. Caja Vel.
Jogo Caixa Câmbio



JV-113
Jgo. Caja Vel.
Jogo Caixa Câmbio



JB-128
Jgo. Carb.
Jogo Carb.



JB-129
Jgo. Carb.
Jogo Carb.



JB-130
Jgo. Carb.
Jogo Carb.



JB-176
Jgo. Carb.
Jogo Carb.

DESCRIPCIÓN / Descrição / Description

FIAT: 128 - Regatta - Duna - Ritmo 1986/90
 Elba - Premio - Fiorino - Uno - S. Europa 83/...
LANCIA: Delta - Prisma 1986/... (1041254)

MOTOR / Engine	CM ³	HP	Ø PISTON
138C3	1498	75/85	86.40
831B1	1498	82/85	86.40

Juego Completo de Reparación:

Jogo de Juntas do Motor / Full Set Gasket:

JR-294-15



Semi-Juego de Reparación:

Semi-Jogo de Juntas / Semi-Set Gasket:

Juego de Descarbonización:

Jogo de Juntas Superior / Head Set Gasket:

JD-136-15



JUNTA CULATA DE CILINDROS	TC-454-15	Ø 87.70mm	1.60mm	↑ ↓
Junta de cabeçote	TC-454-18 <td>Ø 87.70mm <td>2.30mm <th>↑ ↓</th> </td></td>	Ø 87.70mm <td>2.30mm <th>↑ ↓</th> </td>	2.30mm <th>↑ ↓</th>	↑ ↓
Cylinder Head gasket				↑ ↓

JD-136-15

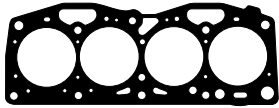

TC-454 - 5957865
 Junta Culata de Cilindros
 Junta Cabeçote



JAE-180 - 4195133/4309031
 Múltiple Admisión y Escape
 Coletor Admissão e Escapamento

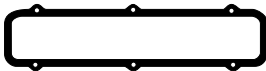

JVS-132-30
 Junta Tapa Válvula Superior
 Junta Tampa Válvula Superior

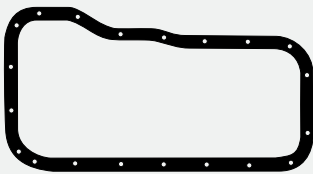

JC-147-30 - 4179038
 Junta Cártel
 Junta Carter



1029300 - 4179043
 7737203
 Tapa distribución
 Tampa distribuição



1029800 - 4179138
 Bomba de aceite
 Bomba de óleo



1026700 - 4179113
 4081258
 Bomba de nafta
 Bomba de gasolina



1030000 - 4179154
 97052378
 Bomba de agua
 Bomba de água



1127700 - 4396562
 5937811
 Tapa block
 Tampa bloco



1030500 - 4195119
 7737204
 Porta retén distribución
 Flange Diant. do Virabrequim



1139000 - 7770023
 Bomba de agua
 Bomba de água



1094600 - 4205663
 Bomba de nafta a block
 Bomba de gasolina ao bloco
 (0,8mm)



RT-6487Pol
 Retén Bancada
 Ret. Traseiro do Virabrequim
 Lx-R 64,00 x 80,00 x 8,00



RT-6123Pol
 Retén distribución
 Retentor Dianteiro do Virabrequim
 Mx-R 40,00 x 56,00 x 7,00



1030600 - 4198159/97052380
 Base termostato
 Base termostato



1030400 - 4194902
 Brida caño calefactor
 Flange cano aquecedor



1135300 - 4179117
 Tapa árbol de levas
 Tampa árvore de comando (0,8mm)



JVL-126-25 - 4217916/97051650
 Junta Tapa Válvula Lateral (1mm)



1138900 - 4230783
 Bomba de aceite tubo escape
 Bomba de óleo tubo escapamento



1030300 - 4193959
 Soporte caño agua



1029900 - 4179148
 Caño bomba de aceite
 Tubo bomba óleo



1029200 - 4158100
 Descarga gases
 Retorno gases



1138800
 Base filtro de aceite
 Base filtro de óleo



1029600 - 4179114
 Bomba de nafta a block
 Bomba de gasolina ao bloco (0,5mm)



1094700 - 4205664
 Bomba de nafta a block
 Bomba de gasolina ao bloco (1,5mm)



1127500
 Tapa block
 Tampa bloco



1029400
 Porta retén bancada
 Porta retentor mancal



1030000 - 4179154
 97052378
 Bomba de agua
 Bomba de água



1127700 - 4396562
 5937811
 Tapa block
 Tampa bloco

Productos relacionados no incluidos en el juego. Los mismos pueden ser solicitados por separado

Produtos relacionados não incluídos no jogo. Podem ser solicitados em separado / Related products that were not included in the set but can be ordered separately.



BU-006
 Bulones para Culata de Cilindros
 Parafusos de cabeçote

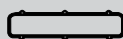

JVS-132-25
 Tapa Válvula Superior
 Tampa Vál. Superior



JAE-180-09
JAE-180-11
 Múltiple Admisión y Escape
 Coletor Admissão e Escapamento



JAE-280
 Múltiple Admisión y Escape
 Coletor Admissão e Escapamento



JC-147-23
 Junta Cártel
 Junta Carter



JB-253-INY
 Jgo. Carb.
 Jogo Carb.



JB-213
 Jgo. Carb.
 Jogo Carb.



JSA-188-17
 Salida Escape
 Saída Escapamento



JSA-217
 Arandela Suplemento
 Arruela Suplemento



JVL-126-28 - (0,2mm)
JVL-126-29 - (0,3mm)
JVL-126-24 - (0,5mm)
JVL-126-34 - (0,8mm)
 Tapa Válvula Lateral
 Tampa Válvula Lateral



1029700 - (0,3mm)
1135100 - (0,5mm)
 Tapa Árbol de Levas
 Tampa árvore de comando



JSA-233-21
JSA-233-22
 Salida Escape
 Saída Escape



JB-214
 Jgo. Carb.
 Jogo Carb



JB-231
 Jgo. Carb.
 Jogo Carb



JB-207
 Jgo. Carb.
 Jogo Carb

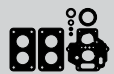

JB-212
 Jgo. Carb.
 Jogo Carb

Juego Completo de Reparación:

Jogo de Juntas do Motor / Full Set Gasket:

JR-384-15

DESCRIPCIÓN / Descrição / Description

DIESEL**Semi-Juego de Reparación:**

Semi-Jogo de Juntas / Semi-Set Gasket:

SJ-121**FIAT:** Ritmo - Premio - Fiorino - Uno 75CV IE Regatta 1986/...**Juego de Descarbonización:**

Jogo de Juntas Superior / Head Set Gasket:

JD-121-15

JUNTA CULATA DE CILINDROS	TC-537-15	Ø 87.70mm	1.60mm	↕
Junta de cabeçote				↕
Cylinder Head gasket				↕

MOTOR / Engine	CM ³	HP	Ø PISTON
149C1.000	1498	75	86.40
138/C3.048/1.048/3.048	1498	75	86.40
483C3.149	1498	75/76	86.40
149A5.000	1498	75	86.40

ILLINOIS

FIAT

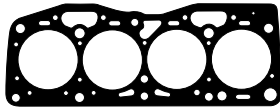
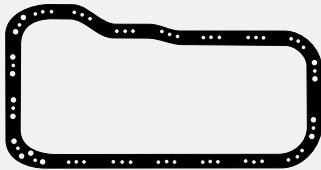
**JD-121-15****TC-537-15**Junta Culata de Cilindros
Junta Cabeçote**JAE-348** - 7665722/7772495
Múltiple Admisión y Escape
Coletor Admissão e Escapamento**JVS-244-30** - 7554851
Junta Tapa Válvula Superior
Junta Tampa Válvula Superior**JSA-188-11** - 4309031
Salida Escape
Saída Escapamento**1135300** - 4179117
Tapa árbol de levas (0,8mm)
Tampa árvore de comando**JVL-168-24** - 7784728
Junta Tapa Válvula Lateral
Junta Tampa Válvula Lateral (0,5mm)**1030300** - 4193959
Soporte caño agua/Suporte cano água**RT-508Pol**
Jgo. Ret. Guía de Válvulas
Jogo Retentor da Haste de Válvulas**RT-6121Pol**
Retén Árbol de Levas
Ret. do Eixo Comando de Válvulas
Mx-R 30,00 x 52,00 x 7,00**JC-292-30** - 50002911
Junta Carter
Junta Carter**1127500** - 4254031/7575660
Tapa block
Tampa bloco**1030500** - 4195119/7737204
Porta retén distribución
Porta retentor distribuição**1131500** - 4218080
Tapa árbol de levas trasero
Tampa eixo comando de válvulas traseiro**1127600** - 4302267/7737202
Porta retén bancada
Flange Traseiro do Virabrequim**1127700** - 4396562/5937811
Tapa block
Tampa bloco**1127800**
Termostato**1131600** - 4218077
Tapa árbol de levas distribución
Tampa eixo comando de válvulas distribución**1029300** - 4179043/7737203
Tapa distribución
Tampa distribuição**1199500** - 7668667/7597760
Tapa inspección
Tampa inspeção**1030100** - 4179155
Base bomba de agua
Base bomba de água**1029200** - 4158100
Descarga gases
Retorno gases**1029800** - 4179138
Bomba de aceite
Bomba de óleo**RT-6487Pol**
Retén Bancada
Ret. Traseiro do Virabrequim
Lx-R 64,00 x 80,00 x 8,00**RT-6123Pol**
Retén Distribución
Retentor Dianteiro do Virabrequim
Mx-R 40,00 x 56,00 x 7,00

Productos relacionados no incluidos en el juego. Los mismos pueden ser solicitados por separado

Produtos relacionados não incluídos no jogo. Podem ser solicitados em separado / Related products that were not included in the set but can be ordered separately.

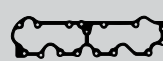
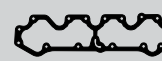
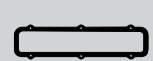
**BU-006**
Bulones para
Culata de Cilindros
Parafusos de Cabeçote**JB-252-INY**
Juego Carburador
Jogo Carburador**1029700** - 4179117 (0,3mm)
1135100 - 4179117 (0,5mm)
Tapa Árbol de Levas
Tampa Eixo Comando de Válv.**JVL-162-24** - (0,5mm)
JVL-162-28 - (0,2mm)
JVL-162-29 - (0,3mm)
JVL-162-34 - (0,8mm)
Junta Tapa Válvula Lateral
Junta Tampa Válvula Lateral**JVL-168-28** - (0,2mm)
JVL-168-29 - (0,3mm)
JVL-168-34 - (0,8mm)
Junta Tapa Válvula Lateral
Junta Tampa Válv. Lateral**JVS-244-23**
Junta Tapa/Tampa
Válvula Superior**JAE-348-09** - 7665722/7772495
Múltiple Admisión y Escape
Coletor Admissão e Escapamento**JC-292-23**
Junta Carter
Junta Carter**JSA-188-17** - 4309031
Salida Escape
Saída Escapamento

DESCRIPCIÓN / Descrição / Description

FIAT: Duna - Uno - Regatta - Palio - Siena - Punto Premio - Tipo - Elba - Fiorino 1988/... - Tempra
LANCIA: Dedra 1989/93 (7604404/7564332)

MOTOR / Engine	CM ³	HP	Ø PISTON
Sevel	1581	84/88	86.40
146C6	1581	75	86.40
159A3	1581	76/86	86.40
160A2 - 835A	1581	80/82/90	86.40

Juego Completo de Reparación:

Jogo de Juntas do Motor / Full Set Gasket:

JR-341-15



Semi-Juego de Reparación:

Semi-Jogo de Juntas / Semi-Set Gasket:

SJ-340



Juego de Descarbonización:

Jogo de Juntas Superior / Head Set Gasket:

JD-137-15



JUNTA CULATA DE CILINDROS

Junta de cabeçote
 Cylinder Head gasket

TC-535-15	Ø 87.70mm	1.60mm
TC-535-18	Ø 87.70mm	2.30mm

JD-137-15

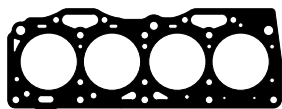

TC-535-15 - 7604404/7564332
 Junta Culata de Cilindros
 Junta Cabeçote



JSA-188-11 - 4309031
 Salida Escape
 Saída Escapamento



1187400
 Base carburador
 Base carburador



1187500
 Base carburador



1187600
 Base termostato



JAE-348 - 7665722/7772495
 Múltiple Admisión y Escape
 Coletor Admissão e Escapamento

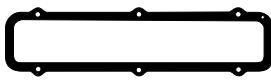

JVS-244-30 - 7554851
 Junta Tapa Válvula Superior
 Junta Tampa Válvula Superior



1030800 - 4206146/4428157
 Base carburador
 Base carburador



RT-508Pol
 Juego Retenes Guía de Válv.
 Jogo Retentor da Haste de Válvulas



JVL-168-24 - 7784728
 Junta Tapa Válvula Lateral
 Junta Tampa Válvula Lateral (0,5mm)



1135300 - 4179117
 Tapa árbol de levas
 Tampa eixo comando de válvulas (0,8mm)



1127800 - 46584559/7615049
 Termostato
 Termostato



RT-6121Pol
 Retén Árbol de Levas
 Ret. Eixo Comando de Válv.
 Mx-R 30,00 x 52,00 x 7,00

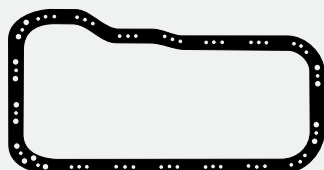

JC-292-30 - 50002911
 Junta Carter
 Junta Carter



1030300 - 4193959
 Soporte caño agua
 Soporte cano água



1138900 - 4230783
 Bomba de aceite tubo escape
 Bomba de óleo tubo escapamento



1029900 - 4179148
 Caño bomba de aceite
 Cano bomba de óleo



1029300 - 4179043/7737203
 Tapa distribución
 Tampa distribuição



1127600 - 4302267/7737202
 Porta retén bancada
 Flange Traseiro do Virabrequim



1127500 - 4254031/7575660
 Tapa block
 Tampa bloco



1029200 - 4158100
 Descarga gases
 Saída de gases



1029800 - 4179138
 Bomba de aceite
 Bomba de óleo



1030500 - 4195119/7737204
 Porta retén distribución
 Flange dianteiro do virabrequim



1199500 - 7668667/7597760
 Tapa inspección
 Tampa inspeção



1127700 - 4396562/5937811
 Tapa block
 Tampa bloco



1122100 - 4109133
 Distribución
 Distribuição



1030400 - 4194902
 Brida caño calefactor
 Flange cano aquecedor



1094600 - 4205663
 Bomba de nafta a block (0,8mm)
 Bomba de gasolina ao bloco



1094700 - 4205664
 Bomba de nafta a block (1,5mm)
 Bomba de gasolina ao bloco



1029600 - 4179114
 Bomba de nafta a block (0,5mm)
 Bomba de gasolina ao bloco



1026700 - 4179113
 4081258
 Bomba de nafta
 Bomba de gasolina



1030000 - 4179154
 97052378
 Bomba de agua
 Bomba de água



1030100 - 4179155
 Base bomba de agua
 Base bomba de água



RT-6487Pol
 Retén Bancada
 Ret. Traseiro do Virabrequim
 Lx-R 64,00 x 80,00 x 8,00



RT-6123Pol
 Retén Distribución
 Ret. Dianteiro do Virabrequim
 Mx-R 40,00 x 56,00 x 7,00

Productos relacionados no incluidos en el juego. Los mismos pueden ser solicitados por separado

Produtos relacionados não incluídos no jogo. Podem ser solicitados em separado / Related products that were not included in the set but can be ordered separately.



BU-006
 Bulones para Culata de Cilindros
 Parafusos de Cabeçote



JV-134
 Jgo. Caja Velocidad
 Jogo Caixa Câmbio



JB-206
 Jgo. Carburador
 Jogo Carburador



JC-292-23
 Junta Carter
 Junta Carter

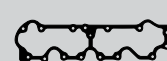

JVL-162-24 - (0,5mm)
JVL-162-28 - (0,2mm)
JVL-162-29 - (0,3mm)
JVL-162-34 - (0,8mm)
 Junta Tapa Válvula Lateral
 Junta Tampa Válvula Lateral

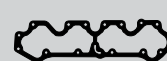

JVL-168-28 - (0,2mm)
JVL-168-29 - (0,3mm)
JVL-168-34 - (0,8mm)
 Junta Tapa/Tampa Vál. Lat.



1029700 - (0,3mm)
1135100 - (0,5mm)
 Tapa Árbol de Levas
 Tampa Árvore de Comando



JSA-188-17
 4309031
 Salida Escape
 Saída Escapamento



JB-233
 Jgo. Carburador
 Jogo Carburador



JAE-348-09 - 7665722
 7772495
 Múltiple Admisión y Escape
 Coletor Admissão e Escapamento



JVS-244-23
 Junta Tapa Vál. Sup.
 Junta Tampa Vál. Sup.

Juego Completo de Reparación:

Jogo de Juntas do Motor / Full Set Gasket:

JR-382-15**Semi-Juego de Reparación:**

Semi-Jogo de Juntas / Semi-Set Gasket:

SJ-382**Juego de Descarbonización:**

Jogo de Juntas Superior / Head Set Gasket:

JD-382-15

JUNTA CULATA DE CILINDROS	TC-618-15	∅ 87.70mm	1.60mm	∅
	TC-618-18	∅ 87.70mm	2.30mm	∅
Junta de cabeçote				∅
Cylinder Head gasket				∅

DESCRIPCIÓN / Descrição / Description

FIAT: Palio - Siena - Tipo 1,6 - Bravo - Marea Strada - Brava - Multipla 1999/...

LANCIA: Delta - Dedra - Lybra 1996/...

MOTOR / Engine	CM ³	HP	∅ PISTON
178B/182A4	1581	103	86.40
182A6	1581	90/103	86.40
185A3	1581	103	86.40
186A4 - Torque 16V	1581	103	86.40

ILLINOIS

FIAT

JD-382-15

TC-618-15 - 46410960
Junta Culata de Cilindros
Junta Cabeçote



2743100 - 46402220
Juego toberas admisión
Jogo coletor admissão



1192400
Mariposa aire tapa
Borboleta ar tampa



1029800 - 4179138
Bomba de aceite
Bomba de óleo



JAE-433-A - 46410505
Junta Admisión
Junta Admissão



JAE-432-E - 46412116
Junta Escape
Junta Escapamento



2704100
O'Ring 55,25 x 2,62mm



2704200 - 46428901
O'Ring 59,92 x 3,53mm

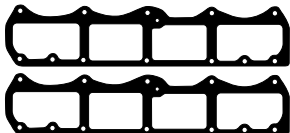

JVS-291-15 - 7773831
Junta Tapa Válvulas Superior
Junta Tampa Válvulas Superior



1029300 - 4179043/7737203
Tapa distribución
Tampa distribuição



JSA-188-11 - 4309031
Salida Escape
Saída Escapamento



RT-565Pol
Juego de Retenes Guía de Válvulas
Jogo Retedor da Haste de Válvulas

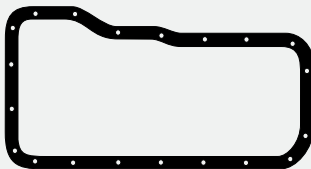

JC-326-26 - 7663366/4179038
Junta Cáster
Junta Carter



1030500 - 4195119/7737204
Porta retén distribución
Porta retentor distribuição



1192500
Tapa bomba de aceite
Tampa bomba de óleo



RT-6121Pol
Retén Árbol de Levas
Retentor do Eixo Comando de Válv.
Mx-R 30,00 x 52,00 x 7,00



1192200 - 4902267
Porta Retén
Porta Retentor



1192300 - 7770023
Pasaje de agua a tapa
Passagem de água ao cabeçote



RT-6123Pol
Retén Distribución
Ret. Dianteiro do Virabrequim
Mx-R 40,00 x 56,00 x 7,00

2727400 - Juego Arandelas de Goma/Jogo Arruelas de Borracha

Gráfico	Descripción/Descrição	Cant./Quant.
	O'ring 88,57x2,62mm	1
	O'ring 66,27x3,53mm	1
	O'ring 50,39x3,53mm	1
	O'ring 31,34x3,53mm	1
	O'ring 26,57x3,53mm	1
	O'ring 18,72x2,62mm 7792371	1
	O'ring 17,12x2,62mm 7792369	1
	O'ring 6,07x1,78mm	1

Productos relacionados no incluidos en el juego. Los mismos pueden ser solicitados por separado.

Produtos relacionados não incluídos no jogo. Podem ser solicitados em separado.

Related products that were not included in the set but can be ordered separately.



BU-008
Bulones para Culata de Cilindros
Parafusos de Cabeçote



JB-251-INY
Juego Carburador
Jogo Carburador



RT-9830Vit
Porta Retén Bancada
Flange Tras. do Virabrequim
A 316-R 64,00



JSA-188-17 - 4309031
Salida Escape
Saída Escapamento

DESCRIPCIÓN / Descrição / Description

FIAT: Palio - Siena - Marea - Multipla 2001/...

MOTOR / Engine	CM ³	HP	Ø PISTON
182 B6.000	1596	103	86.40
178 E7.000	1596	90/103	86.40
Torque 16V			

Juego Completo de Reparación:

Jogo de Juntas do Motor / Full Set Gasket:

JR-753-15

R

Semi-Juego de Reparación:

Semi-Jogo de Juntas / Semi-Set Gasket:

SJ-753

R

Juego de Descarbonización:

Jogo de Juntas Superior / Head Set Gasket:

JD-753-15

R

JUNTA CULATA DE CILINDROS	TC-955-15	Ø 81.00mm	1.50mm	↑ ↓
Junta de cabeçote				↑ ↓
Cylinder Head gasket				↑ ↓

JD-753-15

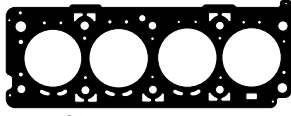

TC-955-15 - 46752127
Junta Culata de Cilindros
Junta Cabeçote



2743100 - 46402220
Juego toberas Admisión
Jogo coletor admissão



1192400
Mariposa aire tapa
Borboleta ar tampa



1029800 - 4179138
Bomba de aceite
Bomba de óleo



JAE-433-A - 46410505
Junta Admisión
Junta Admissão



JAE-432-E - 46412116
Junta Escape
Junta Escapamento



2704100
O'Ring 55,25 x 2,62mm



2704200 - 46428901
O'Ring 59,92 x 3,53mm

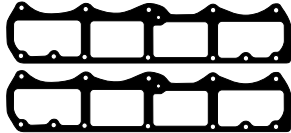

JVS-291-15 - 7773831
Junta Tapa Válvulas Superior
Junta Tampa Válvulas Superior



1029300 - 4179043/7737203
Tapa distribución
Tampa distribuição



JSA-188-11 - 4309031
Salida Escape
Saída Escapamento



RT-565Pol
Juego de Retenes Guía de Válvulas
Jogo Retentor da Haste de Válvulas



JC-326-26 - 7663366/4179038
Junta Cártel
Junta Carter



1030500 - 4195119/7737204
Porta retén distribución
Flange Dianteiro do Virabrequim



1192500
Tapa bomba de aceite
Tampa bomba de óleo



RT-6121Pol
Retén Árbol de Levas
Retentor do Eixo Comando
de Válvulas
Mx-R 30,00 x 52,00 x 7,00



1192200 - 4902267
Porta Retén
Flange Retentor



1192300 - 7770023
Pasaje de agua a tapa
Passagem de água ao cabeçote



RT-6123Pol
Retén Distribución
Retentor Dianteiro do
Virabrequim
Mx-R 40,00 x 56,00 x 7,00

2727400 - Juego Arandelas de Goma/Jogo Arruelas de Borracha

Gráfico	Descripción/Descrição	Cant./Quant.
○	O'ring 88,57x2,62mm	1
○	O'ring 66,27x3,53mm	1
○	O'ring 50,39x3,53mm	1
○	O'ring 31,34x3,53mm	1
○	O'ring 26,57x3,53mm	1
○	O'ring 18,72x2,62mm 7792371	1
○	O'ring 17,12x2,62mm 7792369	1
○	O'ring 6,07x1,78mm	1

Productos relacionados no incluidos en el juego. Los mismos pueden ser solicitados por separado.

Produtos relacionados não incluídos no jogo. Podem ser solicitados em separado.

Related products that were not included in the set but can be ordered separately.



BU-008
Bulones para Culata de Cilindros
Parafusos de Cabeçote



RT-9830Vit
Porta Retén Bancada
Flange Traseiro do Virabrequim
A 316-R 64,00



JSA-188-17 - 4309031
Salida Escape
Saída Escapamento

Juego Completo de Reparación:

Jogo de Juntas do Motor / Full Set Gasket:

JR-734**R****Semi-Juego de Reparación:**

Semi-Jogo de Juntas / Semi-Set Gasket:

SJ-734**R****Juego de Descarbonización:**

Jogo de Juntas Superior / Head Set Gasket:

JD-734**R**

JUNTA CULATA DE CILINDROS	TC-934-15	∅ 78.20mm	1.50mm	↑ ↓
Junta de cabeçote	TC-934-MG	∅ 78.20mm	1.50mm	↑ ↓
Cylinder Head gasket				↑ ↓

DESCRIPCIÓN / Descrição / Description

FIAT: Punto - Idea - Linea Palio Essence
Grand Siena - Weekend - Strada 2011/...

MOTOR / Engine	CM ³	HP	∅ PISTON
E-Torq Flex 16V	1598	117	77.00

ILLINOIS

FIAT

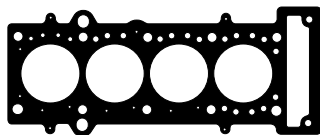
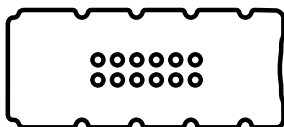
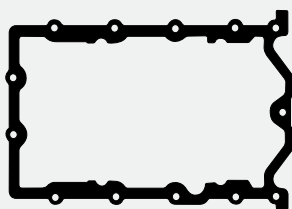
JD-734**TC-934** - 55226527
Junta Culata de Cilindros
Junta Cabeçote**2777000** - 55224542
Capuchon bujías
Protetor velas**2755300** - 46824135
Sensor de temperatura
Sensor de temperatura**JAE-567-A** - 7087745
Juego Admisión
Jogo Admissão**JAE-629-E** - 55224457
Junta Escape
Junta Escapamento**2777100** - 7087746
Cuerpo mariposa
Corpo borboleta**JVS-412-43** - 55224544
Junta Tapa Válvula Superior
Junta Tampa Válvula Superior**2777200**
O'ring Inyector/Injetor
10 x 2mm**RT-2961Pol**
Jgo. Retenes Guía de Válvulas
Jogo Retentor da Haste de Válvulas**2777300** - 7087876
Salida aceite bomba
Saída óleo bomba
22,5 x 27,5 x 5,5mm**2777400** - 7087877
Entrada aceite bomba
Entrada óleo bomba
27 x 32,5 x 4,5mm**RT-8573Pol**
Retén Árbol de Levas
Retentor do Eixo Comando
de Válvulas
Lx-Hel 40,00 x 55,00 x 8,00**JC-411-15** - 55226126
Junta Cáster
Junta Carter**2777500** - 55227126
Bomba de aceite
Bomba de óleo**RT-9663Vit**
Retén Bancada
Retentor Traseiro do Virabrequim
A 278-R 91,00 x 111,00 x 10,00**2700900** - 55229787
O'ring 20,3 x 2,62mm**2777600** - 55231652
Filtro aceite
Filtro óleo**RT-2962Vit**
Retén Distribución
Retentor Dianteiro do Virabrequim
32,00 x 45,00 x 6,50

Productos relacionados no incluidos en el juego. Los mismos pueden ser solicitados por separado.

Produtos relacionados não incluídos no jogo. Podem ser solicitados em separado.

Related products that were not included in the set but can be ordered separately.

**BU-243**
Bulones para
Culata de Cilindros
Parafusos de Cabeçote

DESCRIPCIÓN / Descrição / Description

FIAT: Argenta - Ritmo - Regatta 100S 1985/...
Strada - 131 Sup. Mirafiori - 124 72/78 - 132 77/85
LANCIA: Beta - Trevi - Prisma - Delta 1982/84

MOTOR / Engine	CM ³	HP	Ø PISTON
149A	1585	100	84.00
138 ARO/2ACT	1585	98/105	84.00
132 A70	1756	105/118	84.00
132 C2	1995	113/115	84.00

Juego Completo de Reparación:

Jogo de Juntas do Motor / Full Set Gasket:

JR-295-15

R

Semi-Juego de Reparación:

Semi-Jogo de Juntas / Semi-Set Gasket:

SJ-295

R

Juego de Descarbonización:

Jogo de Juntas Superior / Head Set Gasket:

JD-295-15

R

JUNTA CULATA DE CILINDROS	TC-455-15	Ø 85.00mm	1.60mm	1.60mm	1.60mm
Junta de cabeçote					
Cylinder Head gasket					

JD-295-15



TC-455-15 - 5951674
Junta Culata de Cilindros
Junta Cabeçote



JSA-117 - 4166914/4176386
Salida Escape
Saída Escapamento



RT-508Pol
Juego Retenes
Guía de Válvulas
Jogo Retentor da Haste
de Válvulas



RT-6121Pol
Retén Árbol de Levas
Retentor do Eixo Comando
de Válvulas
Mx-R 30,00 x 52,00 x 7,00



JVS-133-30 - 4158646
Junta Tapa Válvula Superior c/arandelas
Junta Tampa Válvula Superior c/arruelas



JAE-182-A - 4194060
Junta Admisión
Junta Admissão



2739200 - 5949822
O'ring 36 x 3mm
Salida de agua
Saída de água



JVL-125-34 - 4268806
Junta Tapa Válvula Lateral
Junta Tampa Válvula Lateral (0,8mm)



JAE-181-E - 4177112
Junta Escape
Junta Escapamento



1031400 - 4123150
Árbol de levas (0,3mm)
Eixo Comando de Válvulas

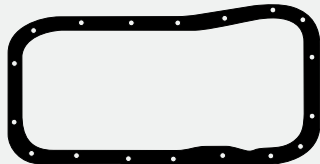

JC-308-30 - 4331606
Junta Cártel
Junta Carter



1151400 - 4336939
Pescador bomba de aceite
Pescador bomba óleo



1152100 - 4304656
Bomba de aceite
Bomba de óleo



1031300 - 4129820
Caño calefacción
Cano aquecedor



1152300 - 4319009
Bomba de nafta
Bomba de gasolina



1031700 - 4188704
Salida termostato
Saída termostato



1156200 - 97053144
Tapa inspección cámara de agua
Tampa inspeção câmara de água



1157300
Bomba de agua reforma
Bomba de água reforma



1151500 - 4475631
Base bomba de agua
Base bomba de água



1031800 - 4190916
Tapa del motor
Tampa do motor



1157400 - 4475631/7679976
Bomba de agua
Bomba de água



1154300
Base carburador
Base carburador



1152400 - 4337093
Base filtro de aceite
Base filtro de óleo



1031100 - 4129763
21011005155
Tapa retén bancada
Tampa retentor traseiro do virabrequim



1031500 - 4130903
Tapa retén distribución
Tampa retentor dianteiro do virabrequim



RT-8271Pol
Retén Bancada
Retentor Traseiro do Virabrequim
Mx-R 74,00 x 90,00 x 10,00



RT-8412Pol
Retén Distribución
Ret. Dianteiro do Virabrequim
Mz-R 30,00 x 43,00 x 8,00



1150200
Tapa inspección cámara de agua
Tampa inspeção câmara de água



1150300
Filtro lubricación
Filtro lubrificação

Productos relacionados no incluidos en el juego. Los mismos pueden ser solicitados por separado

Produtos relacionados não incluídos no jogo. Podem ser solicitados em separado / Related products that were not included in the set but can be ordered separately.



JB-226
Jgo. Carburador
Jogo Carburador



1131800 - 4123150
Árbol de Levas (0,5mm)
Eixo Comando de Válvulas



JVL-125-28 - (0,2mm)
JVL-125-29 - (0,3mm)
Junta Tapa/Tampa Vál. Lat.



JVL-125-24 - (0,5mm)
JVL-125-25 - (1mm)
Junta Tapa/Tampa Vál. Lat.



JVL-125-15 (1,2mm)
Junta Tapa/Tampa Vál. Lat.



JSA-117-11
Salida Escape
Saída Escapamento

Juego Completo de Reparación:

Jogo de Juntas do Motor / Full Set Gasket:

JR-358-15**Semi-Juego de Reparación:**

Semi-Jogo de Juntas / Semi-Set Gasket:

SJ-358**Juego de Descarbonización:**

Jogo de Juntas Superior / Head Set Gasket:

JD-358-15

JUNTA CULATA DE CILINDROS	TC-617-15	∅ 85.00mm	1.60mm	∓
	TC-617-18	∅ 85.00mm	2.30mm	∓
Junta de cabeçote				∓
Cylinder Head gasket				∓

DESCRIPCIÓN / Descrição / Description

FIAT: Regatta 100 - 2000 - Tempra 1989/...
Bialbero 8V - Tipo IE - Ritmo 100 - Cromia IE
LANCIA: Delta HF Turbo - Dedra Integrale
Prisma - Thema IE

MOTOR / Engine	CM ³	HP	∅ PISTON
149 A4048	1585	83/100	84.00
831B 6000	1585	90/96	84.00
835A 7000	1995	169/180	84.00
154C A1000	1995	90/110	84.00

ILLINOIS

FIAT

JD-358-15

TC-617-15 - 7709257/7604263
 Junta Culata de Cilindros
 Junta Cabeçote



1149300 - 7541231
 Tapa base termostato
 Tampa base termostato



JSA-117 - 4166914/4176386
 Salida Escape
 Saída Escapamento



1149400 - 7547667
 Inspección árbol de levas
 Inspeção eixo comando de válvulas



JAE-387-A - 7546474
 Junta Admisión
 Junta Admissão



JAE-181-E - 4177112
 Junta Escape
 Junta Escapamento



2739200 - 5949822
 O'ring 36 x 3mm
 salida de agua
 saída de agua



2736700 - 595923392
 Arandela goma inferior
 base termostato
 Arruela borracha inferior
 base termostato



JVS-253-25 - 7574967
 Junta Tapa Válvula Superior
 Junta Tampa Válvula Superior



1150400 - 97053371
 Base carburador
 Base carburador



2736200 - 4161222
 Tapa carga aceite
 Tampa abastecimiento óleo



JVL-164-24 - 5966008
 Junta Tapa Válvula Lateral
 Junta Tampa Válvula Lateral



RT-508Pol
 Juego Retenes Guía de Válvulas
 Jogo Retentor da Haste
 de Válvulas



RT-6121Pol
 Retén Árbol de Levas
 Ret. do Eixo Comando de Válvulas
 Mx-R 30,00 x 52,00 x 7,00

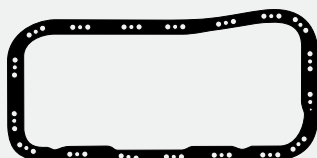

JC-305-30 - 7646248
 Junta Cártér
 Junta Carter



1142300 - 7625508/7589509
 Tapa distribución
 Tampa distribuição



1142600 - 46412804/5969318
 Bomba de aceite
 Bomba de óleo



1150500 - 5873131
 Tubo respiración
 Tubo respiração



1157400 - 4475631/7679976
 Bomba de agua
 Bomba de água



1031100 - 4129763
 21011005155
 Tapa retén bancada
 Retentor traseiro do virabrequim



1142900 - 7668658/5960717
 Tapa block
 Tampa bloco



1152400 - 4337093
 Base filtro de aceite
 Base filtro de óleo



1029200 - 4158100
 Descarga gases
 Saída de gases



RT-8271Pol
 Retén Bancada
 Retentor Traseiro do Virabrequim
 Mx-R 74,00 x 90,00 x 10,00



RT-8412Pol
 Retén Distribución
 Retentor Dianteiro do Virabrequim
 Mz-R 30,00 x 43,00 x 8,00

Productos relacionados no incluidos en el juego. Los mismos pueden ser solicitados por separado.

Produtos relacionados não incluídos no jogo. Podem ser solicitados em separado.

Related products that were not included in the set but can be ordered separately.



JB-216
 Juego Carburador
 Jogo Carburador



JSA-117-11 - 4166914/4176386
 Salida Escape
 Saída Escapamento

DESCRIPCIÓN / Descrição / Description

FIAT: 125 1973/81 - Berlina - Sport
Multicarga - Mirafiori 1972/74

MOTOR / Engine	CM ³	HP	Ø PISTON
125AB - 125A	1608	110	80.00

Juego Completo de Reparación:

Jogo de Juntas do Motor / Full Set Gasket:

JR-193-15



Semi-Juego de Reparación:

Semi-Jogo de Juntas / Semi-Set Gasket:

Juego de Descarbonización:

Jogo de Juntas Superior / Head Set Gasket:

JD-110-15



JUNTA CULATA DE CILINDROS	TC-210-15	Ø 81.30mm	1.60mm	1.60mm	1.60mm
Junta de cabeçote	TC-210-18	Ø 81.30mm	2.50mm	2.50mm	2.50mm
Cylinder Head gasket					



JD-110-15



TC-210-15 - 4185248/4315063
Junta Culata de Cilindros
Junta Cabeçote



JSA-117 - 4166914/4176386
Salida Escape
Saída Escapamento



JAE-182-A - 4194060
Junta Admisión
Junta Admissão



JAE-181-E - 4177112
Junta Escape
Junta Escapamento



1031400 - 4123150
Arbol de levas
Eixo Comando de Válvulas
(0,3mm)

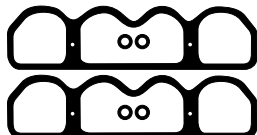

JVS-133-30 - 4158646
Junta Tapa Válvula Superior c/arrandelas
Junta Tampa Válvula Superior c/arruelas

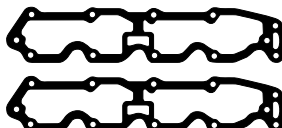

JVL-125-25 - 4268806
Junta Tapa Válvula Lateral
Junta Tampa Válvula Lateral
(1mm)



RT-508Pol
Juego Retenes Guía de Válv.
Jogo Retedor da Haste de Válvulas



RT-6121Pol
Retén Árbol de Levas
Ret. do Eixo Comando de Válv.
Mx-R 30,00 x 52,00 x 7,00

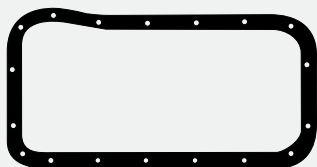

JC-148-30 - 4129756
Junta Carter
Junta Carter



1031700 - 4188704
Salida termostato
Saída termostato



1031300 - 4129820
Caño calefacción
Cano aquecedor



1031000 - 4121068
Bomba de aceite a block
Bomba de óleo a bloco



1030900 - 4109123
Distribuidor
Distribuidor



1031100 - 4129763
21011005155
Tapa retén bancada
Tampa retentor traseiro do virabrequim



1031800 - 4190916
Tapa del motor
Tampa do motor



1031600 - 4135490
Cámara agua posterior
Câmara água posterior



1031200 - 4129813
Bomba de agua block
Bomba de água ao bloco



1096500 - 4135604
Base bomba de aceite
Base bomba de óleo



1031500 - 4130903
Tapa retén distribución
Tampa retentor dianteiro do virabrequim



1198700 - 4081258
21011106170
Base bomba de nafta
Base bomba de gasolina



RT-6677Pol
Retén Bancada
Ret. Traseiro do Virabrequim
Lx-R 70,00 x 90,00 x 10,00



RT-6123Pol
Retén Distribución
Ret. Dianteiro do Virabrequim
Mx-R 40,00 x 56,00 x 7,00

Productos relacionados no incluidos en el juego. Los mismos pueden ser solicitados por separado
Produtos relacionados não incluídos no jogo. Podem ser solicitados em separado / Related products that were not included in the set but can be ordered separately.



JSA-117-11
Salida Escape
Saída Escap.



JV-113
Jgo. Caja. Vel.
Jgo. Caixa Câmbio



JB-134
Jgo. Carb.
Carb.



JB-226
Jgo. Carb.
Jogo Carb.



1131800
Á. de Levas (0,5mm)
Árvore de Comando



JVL-125-28 - (0,2mm)
JVL-125-29 - (0,3mm)
Junta Tapa/Tampa Vál. Lat.



JVL-125-24 - (0,5mm)
JVL-125-25 - (1mm)
Jta. Tapa/Tampa Vál. Lat.



JVL-125-15
Junta Tapa/Tampa
Vál. Lat. (1,2mm)

Juego Completo de Reparación:

Jogo de Juntas do Motor / Full Set Gasket:

R

Semi-Juego de Reparación:

Semi-Jogo de Juntas / Semi-Set Gasket:

SJ-246

R

Juego de Descarbonización:

Jogo de Juntas Superior / Head Set Gasket:

JD-152-ST

R

JUNTA CULATA DE CILINDROS	TC-615 0M	Ø 84.00mm	1.65mm	... a 0,80mm
Junta de cabeçote	TC-615 1M	Ø 84.00mm	1.85mm	de 0,81 a 0,95mm
Cylinder Head gasket	TC-615 2M	Ø 84.00mm	1.95mm	de 0,96 a 1,10mm
	TC-615 3M	Ø 84.00mm	2.10mm	de 1,11mm...
	TC-615 4M	Ø 84.00mm	2.40mm	

DESCRIPCIÓN / Descrição / Description

DIESEL

FIAT: Fiorino - Uno - Tipo - Palio - Duna
 Tempra - Regatta - Ducato - Siena TD
ALFA ROMEO: 145/146 - 155 TD 1993/99
LANCIA: Delta - Dedra 1994/99

MOTOR / Engine	CM ³	HP	Ø PISTON
149B	1697	58	82.60
176A	1697	69/71	82.60
160D-280A1	1929	65	82.60
675.01-336.01	1929	90	82.60

ILLINOIS

FIAT

MENÚ



TC-615-20 0M TC-615-MG 0M - 7785351
TC-615-20 1M TC-615-MG 1M - 7702774/7785352
TC-615-20 2M TC-615-MG 2M - 7647596/7785353
TC-615-20 3M TC-615-MG 3M - 7625508
TC-615-20 4M TC-615-MG 4M

Junta Culata de Cilindros
 Junta Cabeçote

JD-152-ST



JAE-362-E
 4436580/4129763/7765454
 Múltiple Admisión y Escape
 Coletor Admissão e Escapamento



1143300 - 7702768
 Tapa árbol de levas
 Tapa eixo comando de válvulas



1143600 - 7702773
 Tapa cámara agua
 Tapa cámara água



1143200 - 7565461
 Tapa cámara agua
 Tapa cámara água



JVS-252-25 - 4402774/7702774
 Junta Tapa Válvula Superior
 Junta Tapa Válvula Superior

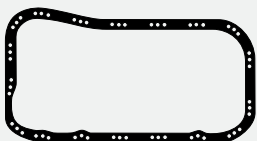

JC-299-30 - 7647596
 Junta Cártér
 Junta Carter



1143800 - 4364121
 Bomba de agua
 Bomba d'água



1143000 - 7696793
 Tapa block
 Tapa bloco



1142400 - 7702766
 Soporte bomba Inyectora
 Suporte bomba injetora



2736200 - 4161222
 Tapa carga aceite
 Tapa carga óleo



1142300 - 7625508/7589509
 Tapa distribución
 Tapa distribuição



1142900 - 7668658/5960717
 Tapa block
 Tapa bloco



1031100 - 4129763
 Tapa retén bancada
 Tapa Traseiro do Virabrequim



RT-6121Pol
 Retén Árbol de Levas
 Ret. do Eixo Comando de Válv.
 Mx-R 30,00 x 52,00 x 7,00



RT-508Pol
 Jgo. Ret. Guía de Vál.
 Jogo Retentor da Haste de Válvulas



1142600 - 46412804/5969318
 Bomba de aceite
 Bomba de óleo



1143400
 Brida
 Flange



1143700 - 7702771
 Base filtro aceite
 Base filtro óleo



1143100
 Salida agua
 Saída água



1011700 - 7702131
 Tapa cámara block
 Tapa cámara bloco



2680500
 Arandela 25 x 30 x1mm
 Arruela (Cobre)



RT-8271Pol
 Retén Bancada
 Retentor Traseiro do Virabrequim
 Mx-R 74,00 x 90,00 x 10,00



RT-8412Pol
 Retén Distribución
 Retentor Dianteiro do Virabrequim
 Mz-R 30,00 x 43,00 x 8,00

Productos relacionados no incluidos en el juego. Los mismos pueden ser solicitados por separado

Produtos relacionados não incluídos no jogo. Podem ser solicitados em separado / Related products that were not included in the set but can be ordered separately.



BU-005

Bul. p/Culata de Cil.
 Parafusos de Cabeçote



JV-160

Jgo. Caja Vel.
 Jgo. Caixa Câmb.



JT-109

Juego Turbo
 Jogo Turbo



JVS-252-15

Junta Tapa/Tampa
 Válvula Superior



JC-299-23

JC-299-26 - (1,5mm)
 Junta Cártér



JAE-362-09

Múltiple Adm. y Esc. (Turbo)
 Coletor Adm. e Escapamento



1152200 - 7704601

Bomba de agua
 Bomba d'água

DESCRIPCIÓN / Descrição / Description

FIAT: Punto - Bravo - Linea - Weekend Adventure
Strada Adventure - Doblo Adventure /Cargo
Idea Adventure 2011/...

MOTOR / Engine	CM ³	HP	Ø PISTON
E-Torq Flex 16V	1747	132	80,50

Juego Completo de Reparación:

Jogo de Juntas do Motor / Full Set Gasket:

JR-735

R

Semi-Juego de Reparación:

Semi-Jogo de Juntas / Semi-Set Gasket:

SJ-735

R

Juego de Descarbonización:

Jogo de Juntas Superior / Head Set Gasket:

JD-735

R

JUNTA CULATA DE CILINDROS	TC-935-15	Ø 82.00mm	1.50mm	
Junta de cabeçote	TC-935-MG	Ø 82.00mm	1.50mm	
Cylinder Head gasket				



JD-735

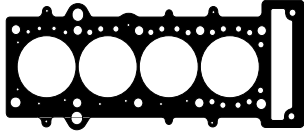

TC-935 - 55231762
Junta Culata de Cilindros
Junta Cabeçote



2777000 - 55224542
Capuchon bujías
Protetor velas



2755300 - 46824135
Sensor de temperatura
Sensor de temperatura



JAE-567-A - 7087745
Juego Admisión
Jogo Admissão



JAE-629-E - 55224457
Junta Escape
Junta Escapamento



2777100 - 7087746
Cuerpo mariposa
Corpo borboleta

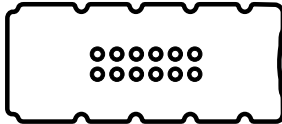

JVS-412-43 - 55224544
Junta Tapa Válvula Superior
Junta Tampa Válvula Superior

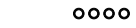

2777200 - 55224544
O'ring Inyector/Injetor
10 x 2mm



RT-2961Pol
Jgo. Retenes Guía de Válvulas
Jogo Retentor da Haste de Válvulas



2777300 - 7087876
Salida aceite bomba
Saída óleo bomba
22,5 x 27,5 x 5,5mm



2777400 - 7087877
Entrada aceite bomba
Entrada óleo bomba
27 x 32,5 x 4,5mm



RT-8573Pol
Retén Árbol de Levas
Retentor do Eixo Comando de Válv.
Lx-Hel 40,00 x 55,00 x 8,00

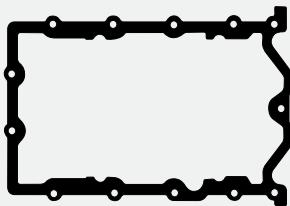

JC-411-15 - 55226126
Junta Cáster
Junta Carter



2777500 - 55227126
Bomba de aceite
Bomba de óleo



RT-9663Vit
Retén Bancada
Retentor Traseiro do Virabrequim
A 278-R 91,00 x 111,00 x 10,00



2700900 - 55229787
O'ring 20,3 x 2,62mm



2777600 - 55231652
Filtro aceite
Filtro óleo



RT-2962Vit
Retén Distribución
Retentor Dianteiro do Virabrequim
32,00 x 45,00 x 6,50



2702400 - 55229989
O'ring 12,37 x 2,62mm

Productos relacionados no incluidos en el juego. Los mismos pueden ser solicitados por separado.

Produtos relacionados não incluídos no jogo. Podem ser solicitados em separado.

Related products that were not included in the set but can be ordered separately.



BU-243
Bulones para
Culata de Cilindros
Parafusos de Cabeçote

Juego Completo de Reparación:

Jogo de Juntas do Motor / Full Set Gasket:

JR-354-15**R****Semi-Juego de Reparación:**

Semi-Jogo de Juntas / Semi-Set Gasket:

SJ-354**R****Juego de Descarbonización:**

Jogo de Juntas Superior / Head Set Gasket:

JD-354-15**R**

JUNTA CULATA DE CILINDROS	TC-617-15	∅ 85.00mm	1.60mm	∓
	TC-617-18	∅ 85.00mm	2.30mm	∓
Junta de cabeçote				∓
Cylinder Head gasket				∓

DESCRIPCIÓN / Descrição / Description

FIAT: Tempra IE 16V - Tipo IE 16V - Coupe IE 16V
Croma IE 16V 1990/96
ALFA ROMEO: 155 Turbo 16V
LANCIA: Delta Integrale 1986/92 - Thema Turbo 16V
Dedra IE - Kappa (7076950)

MOTOR / Engine	CM ³	HP	∅ PISTON
160 A5000	1756	138	84.00
836 A3000/11	1995	142	84.00
834 C1246/2 - Zact 16V	1995	126/145/180	84.00
154E1000/27/160A8046	1995	140/145	84.00

ILLINOIS

FIAT

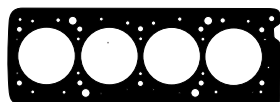
JD-354-15

TC-617-15 - 7709257/7604263
Junta Culata de Cilindros
Junta Cabeçote



JSA-117 - 4166914/4176386
Salida Escape
Saída Escapamento



1147400
Base termostato
Base termostato



JAE-475-A - 7668195
Junta Admisión
Junta Admissão



JAE-386-E - 7700581
Junta Escape
Junta Escapamento



2736200 - 4161222
Tapa carga aceite
Tampa carga óleo



2739200 - 5949822
O'ring 36 x 3mm
saída de agua
saída de água



JVS-318-43 - 7527826
Junta Tapa Válvula Superior
Junta Tampa Válvula Superior



1146100 - 7703016
Soporte turbina
Suporte turbina



RT-6121Pol
Retén Árbol de Levas
Ret. do Eixo Comando de Válvulas
Mx-R 30,00 x 52,00 x 7,00



RT-565Pol
Jgo. Ret.Guía de Válvulas
Jogo Retentor da Haste
de Válvulas

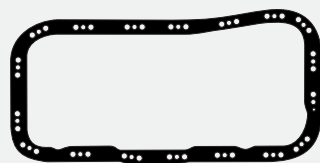

JC-305-30 - 7646248
Junta Carter
Junta Carter

1142600 - 46412804/5969318
Bomba de aceite
Bomba de óleo



1150500 - 5873131
Tubo respiración
Tubo respiração



1147700 - 7625793
Tubo respiradero
Tubo respirador



1145900 - 7639644
Tubo aspiración
Tubo aspiração



1142300 - 7625508/7589509
Tapa distribución
Tampa distribuição



1157400 - 4475631/7679976
Bomba de agua
Bomba de água



1147500 - 7700578
Cuerpo farfalliato
Injeção eletrônica



1152400 - 4337093
Base filtro aceite
Base filtro óleo



1147200 - 7748504
Inspección agua Tempra
Inspeção água Tempra



1031100 - 4129763
21011005155
Tapa retén bancada
Tampa retentor mancal



RT-8271Pol
Retén Bancada Mx-R
Ret. Traseiro do Virabrequim
74,00 x 90,00 x 10,00



RT-8412Pol
Retén Distribución Mz-R
Ret. Dianteiro do Virabrequim
30,00 x 43,00 x 8,00

Productos relacionados no incluidos en el juego. Los mismos pueden ser solicitados por separado.

Produtos relacionados não incluídos no jogo. Podem ser solicitados em separado.

Related products that were not included in the set but can be ordered separately.



JB-252-INY
Juego Carburador
Jogo Carburador



JSA-117-11 - 4166914/4176386
Salida Escape
Saída Escapamento

DESCRIPCIÓN / Descrição / Description

FIAT: Palio - Stilo - Palio Flex - Strada
Siena Flex 2003/... BR - Idea Adventure HLX
G2 - G3 2006/... BR

MOTOR / Engine	CM ³	HP	Ø PISTON
OHC 171/190	1796	103	80.50
17241C1	1796	103	80.50
G2	1796	102/105	80.50
G3	1796	110	80.50

Juego Completo de Reparación:

Jogo de Juntas do Motor / Full Set Gasket:

JR-466

R

Semi-Juego de Reparación:

Semi-Jogo de Juntas / Semi-Set Gasket:

SJ-466

R

Juego de Descarbonización:

Jogo de Juntas Superior / Head Set Gasket:

JD-466

R

JUNTA CULATA DE CILINDROS	TC-165-15	Ø 82.00mm	1.40mm	±0.05
Junta de cabeçote	TC-165-MG	Ø 82.00mm	1.40mm	±0.05
Cylinder Head gasket				



JD-466



TC-165 - 93294583
Junta Culata de Cilindros
Junta Cabeçote



JAE-379-A - 90571862/63
90409709/90106615/96183118
Junta Admisión
Junta Admissão

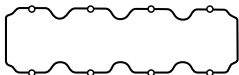

JVS-311-43 - 90409594/7083232/638260
Junta Tapa Válvula Superior
Junta Tampa Válvula Superior



2756500 - 7084981
Junta cuerpo mariposa aceleración G3
Junta corpo borboleta aceleração



JSA-250 - 90128293
854933/94649659
Salida Escape
Saída Escapamento



JAE-378-E - 93227660/90409642
Junta Escape
Junta Escapamento



JAE-368-A - 7084980
Junta Admisión
Junta Admissão



2756700
Guarnición acople admisión G3
Guarnição acoplamento admissão



JSA-306 - 73502844/09202367
Salida Escape G3
Saída Escapamento



2756600
O'ring 38 x 4mm



2710200 - 71716584/7086225
Sensor temperatura de agua (Admisión)
Sensor temperatura de água (Admissão)



RT-594Pol
Juego Retenes Guía de Válvulas
Jogo Retentor da Haste de Válvulas



RT-9205Pol
Retén Árbol de Levas
Ret. do Eixo Comando de Válvulas
Lx-R 35,00 x 48,00 x 7,00

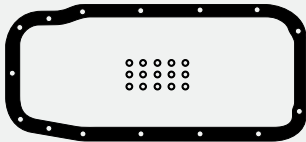

JC-306-30 - 90572656
90409693/93335433
Junta Cártar
c/arandelas limitadoras de apriete
Junta Carter
c/arruelas limitadoras de ajuste



1164700 - 90572062
Salida de gases
Saída de gases



1164600 - 90573301
90353564
Bomba de aceite a block
Bomba de óleo ao bloco



2706800
Bomba de agua
Bomba de água
O'ring 79,5 x 3mm



RT-9270Pol - 93309906
Retén Bancada
Retentor Traseiro do Virabrequim
Lmx-Hel 80,00 x 98,00 x 10,00



RT-9269Pol - 90501719
Retén Distribución
Retentor Dianteiro do Virabrequim
Mx-R 26,00 x 42,00 x 8,00

Productos relacionados no incluidos en el juego. Los mismos pueden ser solicitados por separado.

Produtos relacionados não incluídos no jogo. Podem ser solicitados em separado.

Related products that were not included in the set but can be ordered separately.



BU-052
Bulones para Culata de Cilindros
Parafusos de Cabeçote



JC-306-15
JC-306-25
Junta Cártar
Junta Carter



JSA-250-11
Salida Escape (Láminas)
Saída Escapamento (Camadas)



JAE-378-09
JAE-378-11
Junta Escape
Junta Escapamento

Juego Completo de Reparación:

Jogo de Juntas do Motor / Full Set Gasket:

JR-357-15**R****Semi-Juego de Reparación:**

Semi-Jogo de Juntas / Semi-Set Gasket:

SJ-357**R****Juego de Descarbonización:**

Jogo de Juntas Superior / Head Set Gasket:

JD-357-15**R**

JUNTA CULATA DE CILINDROS	TC-617-15	∅ 85.00mm	1.60mm	∓
Junta de cabeçote	TC-617-18	∅ 85.00mm	1.60mm	∓
Cylinder Head gasket				

DESCRIPCIÓN / Descrição / Description

FIAT: Cromia IE Turbo 1991/96 - Tipo IE
Tempra IE 1990/95 8v (7096175)
LANCIA: Thema IE 1985/92

MOTOR / Engine	CM ³	HP	∅ PISTON
154 C4000/46	1995	153/155	84.00
159 A6096/11	1995	115	84.00
834 B146	1995	115/120	84.00
Zact 8V	1995	120/153	84.00

ILLINOIS

FIAT

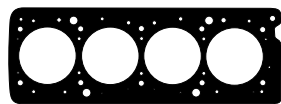
JD-357-15

TC-617-15 - 7709257/7604263
Junta Culata de Cilindros
Junta Cabeçote



1149300 - 7541231
Tapa base termostato
Tampa base termostato



JSA-117 - 4166914/4176386
Salida Escape
Saída Escapamento



1149400 - 7547667
Inspección árbol de levas
Inspeção eixo comando de válvulas



JAE-387-A - 7546474
Junta Admisión
Junta Admissão



JAE-181-E - 4177112
Junta Escape
Junta Escapamento



2739200 - 5949822
O'ring 36 x 3mm
Salida de agua
Saída de água



2736700 - 595923392
Arandela goma inferior base termostato
Arruela borracha inferior base termostato



JVS-319-43 - 7715789
Junta Tapa Válvula Superior c/arandelas y limitadores
Junta Tampa Válvula Superior c/arruelas y limitadores



1141100
Base carburador
Base carburador



2736200 - 4161222
Tapa carga aceite
Tampa carga óleo



JVL-164-24 - 5966008
Junta Tapa Válvula Lateral
Junta Tampa Válvula Lateral



RT-508Pol
Juego Retenes Guía de Válvulas
Jogo Retentor da Haste de Válvulas



RT-6121Pol
Retén Árbol de Levas
Retentor do Eixo Comando de Válv.
Mx-R 30,00 x 52,00 x 7,00

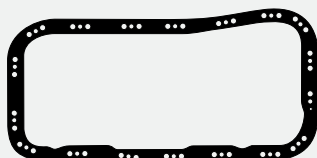

JC-305-30 - 7646248
Junta Carter
Junta Carter



1142300 - 7625508/7589509
Tapa distribución
Tampa distribuição



1031100 - 4129763
21011005155
Tapa retén bancada
Tampa retentor traseiro do virabrequim



1142900 - 7668658
5960717
Tapa block
Tampa bloco



1157400 - 4475631/7679976
Bomba de agua
Bomba de água



1152400 - 4337093
Base filtro aceite
Base filtro óleo



1029200 - 4158100
Descarga gases
Saída de gases



1122100 - 4109133
Distribución
Distribuição



1142600 - 46412804/5969318
Bomba de aceite
Bomba de óleo



1150500 - 5873131
Tubo respiración
Tubo respiração



RT-8271Pol
Retén Bancada
Retentor Traseiro do Virabrequim
Mx-R 74,00 x 90,00 x 10,00



RT-8412Pol
Retén Distribución
Retentor Dianteiro do Virabrequim
Mz-R 30,00 x 43,00 x 8,00

Productos relacionados no incluidos en el juego. Los mismos pueden ser solicitados por separado.

Produtos relacionados não incluídos no jogo. Podem ser solicitados em separado.

Related products that were not included in the set but can be ordered separately.



JSA-117-11 - 4166914/4176386
Salida Escape
Saída Escapamento

DESCRIPCIÓN / Descrição / Description

FIAT: Marea 1996/98 182 A1- Coupe 1996/2001
Bravo 1995/98 - Marea 1998/... 182 E
LANCIA: Kappa - Libra 1996/00

MOTOR / Engine	CM ³	HP	Ø PISTON
182A1	1998	147	82.00
838A1/A6	1998	145/155	82.00
182B3/B7	1998	147/155	82.00

Juego Completo de Reparación:

Jogo de Juntas do Motor / Full Set Gasket:

JR-527-15

R

Semi-Juego de Reparación:

Semi-Jogo de Juntas / Semi-Set Gasket:

SJ-505

R

Juego de Descarbonización:

Jogo de Juntas Superior / Head Set Gasket:

JD-527-15

R

JUNTA CULATA DE CILINDROS	TC-889-15	Ø 83.20mm	1.80mm	±0.05
Junta de cabeçote		Ø		±0.05
Cylinder Head gasket		Ø		±0.05

JD-527-15

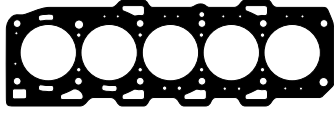

TC-899-15 - 7766268
Junta Tapa de Cilindros
Junta Cabeçote



1127400
Cierre estanqueidad
Garnição



RT-623Pol
Juego Retenes Guía de Válvulas
Jogo Retentor da Haste de Válvulas



JAE-519-A - 7765227
Junta Admisión
Junta Admissão



JAE-520-E - 4652557
Junta Escape
Junta Escapamento



RT-6858Pol
Retén Árbol de Levas
Retentor do Eixo Comando de Válvulas
A 156-R H 30,00 x 42,00 x 7,00

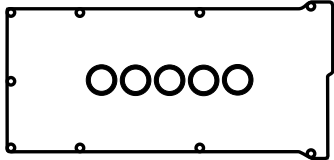

JVS-334-43
Junta Tapa Válvula Superior c/arandelas
Junta Tampa Válvula Superior c/arruelas



1127200
Catalizador
Catalisador



RT-9670Vit
Retén Árbol de Levas
Ret. do Eixo Comando de Válvulas
A 156-R 55,00 x 68,00 x 8,00

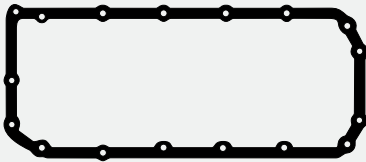

JC-360-30
Junta Cáster
Junta Carter



1126500
Junta Distribución
Junta Distribuição



1127300
Distribución
Distribuição



1126800
Bomba de agua
Bomba de água



2708100
O'ring 79 x 1,8mm



2748600
O'ring 53,64 x 2,62mm



2748500
O'ring 34,65 x 1,78mm



2748700
O'ring 17,17 x 1,78mm



2728400
O'ring 21,89 x 2,62mm



2748400
O'ring 11 x 1,8mm



2608300
Arandela 18 x 22 x 1,5mm
Arruela (Cobre)



RT-05730P
Retén Distribución
Retentor Dianteiro do Virabrequim
31,00 x 41,00 x 7,00

Productos relacionados no incluidos en el juego. Los mismos pueden ser solicitados por separado.

Produtos relacionados não incluídos no jogo. Podem ser solicitados em separado.

Related products that were not included in the set but can be ordered separately.



RT-3004
Porta Retén Bancada
Flange Tras. do Virabrequim
93,00

Juego Completo de Reparación:

Jogo de Juntas do Motor / Full Set Gasket:

Semi-Juego de Reparación:

Semi-Jogo de Juntas / Semi-Set Gasket:

Juego de Descarbonización:

Jogo de Juntas Superior / Head Set Gasket:

JUNTA CULATA DE CILINDROS	TC-694 1M	∅ 89.50mm	± 1.20mm	± de 0,30 a 0,39mm
Junta de cabeçote	TC-694 2M	∅ 89.50mm	± 1.10mm	± de 0,40 a 0,49mm
Cylinder Head gasket	TC-694 3M	∅ 89.50mm	± 1.30mm	± de 0,50 a 0,60mm

SJ-595

R

JD-595-ST

R

DESCRIPCIÓN / Descrição / Description

DIESEL

FIAT: Ducato JTD Multijet 16V 2002/...

IVECO: Daily III 16V 2002/...

CITROEN: Jumper 2010/...

PEUGEOT: Boxer 2010/... (504049360)

MOTOR / Engine	CM ³	HP	∅ PISTON
F1AE0481C	2286	110	88.00
F1AE0481D	2286	120	88.00
F1AE0481N	2286	127	88.00
F1AE0481A	2286	96	88.00

ILLINOIS

FIAT

MENÚ

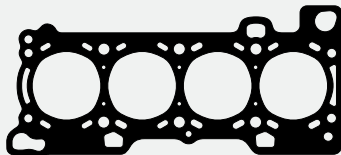

TC-694-20 1M TC-694-MG 1M - 500387068
TC-694-20 2M TC-694-MG 2M - 500387067
TC-694-20 3M TC-694-MG 3M - 500387069
 Junta Culata de Cilindros
 Junta Cabeçote

JD-595-ST



1122000 - 500326581
 Brida Turbo
 Flange Turbo

JT-114 Jgo. Turbo



JT-114-03
 Salida turbo
 Saída turbo



JT-102-02
 3520980280
 Base turbo
 Base turbo



JT-114-01
 Brida chica
 Flange pequena



JT-114-02
 Brida grande
 Flange grande

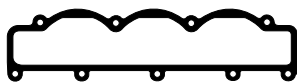

JAE-590 - 504037859
 Junta Admisión
 Junta Admissão



JAE-591 - 500376626
 Junta Escape
 Junta Escapamento

2681500 - Juego Arandelas de Goma/Jogo Arruelas Borracha

Gráfico	Descripción/Descrição	Cant./Quant.
○	O'ring 94x3mm	1
○	O'ring 63,40x2,62mm	1
○	O'ring 53,64x2,62mm	1
○	O'ring 45,69x2,62mm	1
○	O'ring 37,47x5,33mm	1
○	O'ring 32,69x5,33mm	1
○	O'ring 37,7x2,62mm	1
○	O'ring 34,59x2,62mm	1
○	O'ring 28,17x3,53mm	1
○	O'ring 21,82x3,53mm	1
○	O'ring 23,47x2,62mm	1
○	O'ring 9,25x1,78mm	4
○	O'ring 8x1,78mm	1

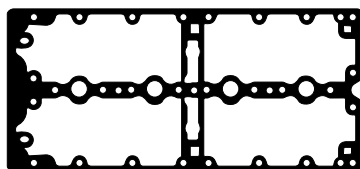

JVS-384-15 - 504019494
 Junta Tapa de Válvula
 Junta Tampa de Válvula



RT-3008Pol
 Juego Retenes Guía de Válvulas
 Jogo Retentor haste de Válvulas

R

2626700 - Juego Arandelas Metálicas/Jogo Arruelas Metalicas

Gráfico	Descripción/Descrição	Cant./Quant.
○	Aran./Arruela 20x26x1,50mm Cobre	1
○	Aran./Arruela 18x22x1,50mm Cobre	1
○	Aran./Arruela 17x21x1,25mm Cobre	2
○	Aran./Arruela 12x19x1,50mm Cobre	3
○	Aran./Arruela 12x17x1,50mm Cobre	8
○	Aran./Arruela 10x14x1,00mm Cobre	2
○	Aran./Arruela 6x9x1,00mm Cobre	1



JC-397-43 - 504018307
 Junta Carter
 Junta Carter



RT-3009Pol
 Retén Árbol de Levas
 Retentor Árvore de Comando
 Lx-R 34,00 x 60,00 x 10,00



2767900
 Semi Carter
 Semi Carter



1192100
 Brida
 Flange



2768000
 Distribución trasera
 Distribuição traseira

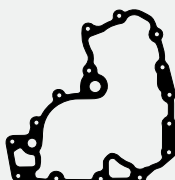

1192000
 Tapa distribución
 Tampa distribuição



1191600
 Bomba de aceite
 Bomba de óleo



RT-3011Pol
 Retén Bancada
 Retentor Traseiro do Virabrequim
 Lx-R 80,00 x 113,00 x 14,00

RT-3010Pol
 Retén Distribución
 Ret. Dianteiro do Virabrequim
 Lx-R 50 x 80,00 x 14,00

R

Productos relacionados no incluidos en el juego. Los mismos pueden ser solicitados por separado.

Produtos relacionados não incluídos no jogo. Podem ser solicitados em separado.

Related products that were not included in the set but can be ordered separately.

DESCRIPCIÓN / Descrição / Description

FIAT: Freemont 2011/...
 DODGE: Journey 2012/...
 JEEP: Compass 2010/...

MOTOR / Engine	CM ³	HP	Ø PISTON
ED3 16V	2360	170/175	88.00
EDG 16V	2360	170/175	88.00

Juego Completo de Reparación:

Jogo de Juntas do Motor / Full Set Gasket:

JR-807-11



Semi-Juego de Reparación:

Semi-Jogo de Juntas / Semi-Set Gasket:

Juego de Descarbonización:

Jogo de Juntas Superior / Head Set Gasket:

JUNTA CULATA DE CILINDROS	TC-650-11	Ø 89.00mm	0.60mm	RECARBONIZADO
Junta de cabeçote				
Cylinder Head gasket				

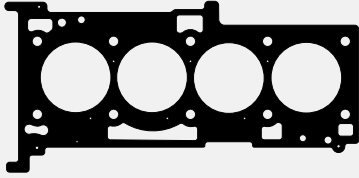

TC-650-11 - 4884798AB/5189976AA
 Junta Culata de Cilindros
 Junta Cabeçote



Junta



Junta



Junta Escape
 Junta Escapamento

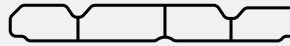

Junta Admisión
 Junta Admissão



Junta

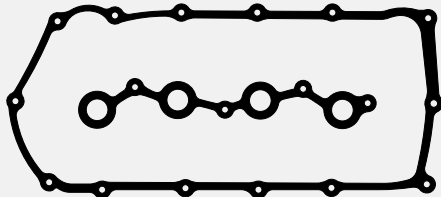

Junta Tapa Válvula Superior
 Junta Tampa Válvula Superior



Bomba de agua
 Bomba de água



Junta



Juego Retenes Guía de Válvulas
 Jogo Retentor da Haste de Válvulas



Retén Distribución
 Retentor Dianteiro do Virabrequim



Retén Bancada
 Retentor Traseiro do Virabrequim



Productos relacionados no incluidos en el juego. Los mismos pueden ser solicitados por separado.

Produtos relacionados não incluídos no jogo. Podem ser solicitados em separado.

Related products that were not included in the set but can be ordered separately.

Juego Completo de Reparación:

Jogo de Juntas do Motor / Full Set Gasket:



Semi-Juego de Reparación:

Semi-Jogo de Juntas / Semi-Set Gasket:

SJ-501



Juego de Descarbonización:

Jogo de Juntas Superior / Head Set Gasket:

JD-501-ST



JUNTA CULATA DE CILINDROS	TC-908-20 1M	Ø 95.00mm	≧ 1.50mm	± 0.05 ... a 0,85mm
	TC-908-20 2M	Ø 95.00mm	≧ 1.60mm	± 0.05 de 0,86 a 0,95mm
Junta de cabeçote	TC-908-20 3M	Ø 95.00mm	≧ 1.70mm	± 0.05 de 0,96 a...
Cylinder Head gasket				

DESCRIPCIÓN / Descrição / Description

DIESEL

FIAT: Nuovo Ducato 1989/94 - Ducato 1994/...

IVECO: Daily 30.8 - 35.8 1996/...

RENAULT: Master 1990/... - Trafic 1990/...

Serie 742/748/770/772/758/780/782 (Iny. Indirecta)

MOTOR / Engine	CM ³	HP	Ø PISTON
8140.67	2445	55	93.00
8140.67X230	2499	85	93.00
8140.67F37	2499	82	93.00
S8U	2499	57/75/80	93.00

ILLINOIS

FIAT

JD-501-ST



TC-908-20 1M
TC-908-20 2M
TC-908-20 3M

Junta Culata de Cilindros
Junta Cabeçote



JAE-412-A - 98425767
Juego Admisión
Jogo Admissão



1088600
Colector admisión
Coletor admissão



1078100 - 98421297
Porta termostato
Porta termostato



RT-3003Vit
Jgo. Ret. Guía de Válvulas
Jogo Retentor da Haste de Válvulas



JVS-268-43 - 500388381
Junta Tapa Válvula Superior
Junta Tampa Válvula Superior



JAE-413-16 - 98434020
Juego Escape (acero inoxidable)
Jogo Escapamento (aço inoxidável)



JSA-291
Salida Escape
Saída Escapamento



1094900 - 98430478
Brida agua
Flange água



RT-3001Pol
Retén Árbol de Levas
Retentor do Eixo
Comando de Válvulas
50,00 x 70,00 x 10,00



RT-2998Pol
Retén Auxiliar
Retentor Auxiliar
55,00 x 70,00 x 8,00



JC-356-30 - 99488483
Junta Carter c/limitadores de apriete
Junta Carter c/limitadores de ajuste



1084100
Tapa cigüeñal trasera
Tampa virabrequim traseira



1084200
Tapa cig. delantera
Tampa virabrequim dianteira



1185500
Filtro aceite
Filtro óleo

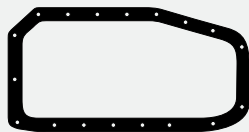

JC-359-30 - 99488486/500327440
Junta Carter c/limitadores de apriete
Junta Carter c/limitadores de ajuste



1084900
Tapa block trasera
Tampa bloco traseira



1088500
Junta tapa del. block
Junta tampa dianteira bloco



1083500
Filtro aceite
Filtro óleo



1008600
Junta distribución
Junta distribuição



1088700 - 98430444
Comando bomba inyectora
Comando bomba injetor



1083100
Bomba de vacío
Bomba de vácuo



1008400
Filtro aceite
Filtro óleo



1094800
Frente distribución
Frente distribuição



1087600
Tapa inspección block
Tampa inspeção bloco



1083300
Base filtro aceite
Base filtro óleo



1008700
Brida Flange



2729200
Intermedia block derecha
Intermediária bloco direita



1008300
Brida Flange



1008200
Brida Flange



1008800
Brida Flange



2729300
Intermedia block izquierda
Intermediária bloco esquerda



1008900
Brida Flange



2631400
Arandela 38 x 46 x 4mm
Arruela (Corcho/cortiça y goma/borracha)



RT-3002Vit
Retén Bancada
Ret. Traseiro do Virabrequim
90,00 x 115,00 x 13,00



RT-3000Pol
Retén Distribución
Ret. Dianteiro do Virabrequim
70,00 x 90,00 x 10,00

Productos relacionados no incluidos en el juego. Los mismos pueden ser solicitados por separado.

Produtos relacionados não incluídos no jogo. Podem ser solicitados em separado.

Related products that were not included in the set but can be ordered separately.



BU-003
Bulones para Culata de Cilindros
Parafusos de Cabeçote



JV-163
Juego Caja Velocidad
Jogo Caixa de Câmbio



RT-9646Vit
Porta Retén Bancada
Flange Traseiro do Virabrequim



RT-9948Vit
Porta Retén Bancada
Flange Traseiro do Virabrequim

2752200 - Juego Arandelas de Goma/Jogo Arruelas de Borracha

Gráfico	Descripción/Descrição	Cant./Quant.
○	O' ring 98,02x3,53mm	1
○	O' ring 64,77x2,62mm	1
○	O' ring 56,87x1,78mm	2
○	O' ring 44,12x2,62mm	1
○	O' ring 31,42x2,62mm	1
○	O' ring 23,47x2,62mm	2
○	O' ring 21,89x2,62mm	1
○	O' ring 21x1,5mm	2
○	O' ring 20,30x2,62mm	15
○	O' ring 20x2mm	2
○	O' ring 18,77x1,78mm	2
○	O' ring 17,12x2,62mm	1
○	O' ring 9,25x1,78mm	3

2630500 - Juego Arandelas Metálicas/Jogo Arruelas Metálicas

Gráfico	Descripción/Descrição	Cant./Quant.
○	Arand./Arruela 28x37x1,5mm Cobre	1
○	Arand./Arruela 22x28x1,5mm Cobre	4
○	Arand./Arruela 20x26x1,5mm Cobre	3
○	Arand./Arruela 14x18x1,5mm Cobre	4
○	Arand./Arruela 12x18x1mm Cobre	4
○	Arand./Arruela 10,3x14x1mm Cobre	2
○	Arand./Arruela 10x14x1mm Alum.	1
○	Arand./Arruela 9x13x0,5mm Cobre	5

DESCRIPCIÓN / Descrição / Description **DIESEL**

FIAT: Ducato TD 1990/94 - Ducato TDS 1994/96
 Ducato TDSE 1996/...
IVECO: Daily Turbo 1990/...

MOTOR / Engine	CM ³	HP	Ø PISTON
8140.27/S	2499	103	93.00
8140.47/R/S	2499	110/116	93.00
8140.47.X30	2499	116	93.00

Juego Completo de Reparación:

Jogo de Juntas do Motor / Full Set Gasket:

Semi-Juego de Reparación:

Semi-Jogo de Juntas / Semi-Set Gasket:

SJ-550

R

Juego de Descarbonización:

Jogo de Juntas Superior / Head Set Gasket:

JD-550-ST

R

JUNTA CULATA DE CILINDROS	TC-823 0M	Ø 96.00mm	1.30mm	de 0.40 a 0.50mm
Junta de cabeçote	TC-823 1M	Ø 96.00mm	1.40mm	de 0.51 a 0.60mm
Cylinder Head gasket	TC-823 2M	Ø 96.00mm	1.50mm	de 0.61 a 0.70mm
	TC-823 3M	Ø 96.00mm	1.60mm	de 0.71 a 0.80mm



TC-823-20 0M TC-823-MG 0M - 99432354
TC-823-20 1M TC-823-MG 1M - 99432353
TC-823-20 2M TC-823-MG 2M - 99460983
TC-823-20 3M TC-823-MG 3M - 99458402
 Junta Culata de Cilindros
 Junta Cabeçote



JVS-284-43
 Junta Tapa Válvula Superior
 Junta Tampa Válvula Superior

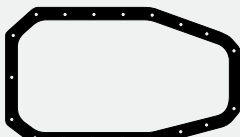

JC-356-30 - 99488483
 Junta Cártel c/limitadores de apriete
 Junta Carter c/limitadores de ajuste



1094800
 Frente distribución
 Frente distribuição



2729200
 Intermedia block derecha
 Intermediária bloco direita



2729300 - 98432857
 Intermedia block izquierda
 Intermediária bloco esquerda



1083500
 Filtro aceite
 Filtro óleo



1083100
 Bomba vacío
 Bomba vácuo



1185500
 Filtro aceite
 Filtro óleo

JD-550-ST



JAE-413-16 - 98434020
 Juego Escape
 (Acero inoxidable)
 Jogo Escapamento
 (Aço inoxidável)



JT-102-02
 213790936885008
 Base Turbo



1088600
 Colector admisión
 Coletor admissão



1008200
 Brida
 Flange



JAE-412-A - 98425767
 Juego Admisión
 Jogo Admissão



1078100 - 98421297
 Porta termostato
 Porta termostato



JSA-291
 98421297
 Salida Escape
 Saída Escapamento



1008800
 Brida/Flange



1008900
 Brida/Flange



1094900 - 98430478
 Brida agua/Flange água



RT-3003Vit
 Juego Retenes
 Guía de Válvulas
 Jogo Retedor da
 Haste de Válvulas



RT-3001Pol
 Retén Árbol de Levas
 Retenedor do Eixo
 Comando de Válvulas
 50,00 x 70,00 x 10,00



RT-2998Pol
 Retén Auxiliar
 Retenedor Auxiliar
 55,00 x 70,00 x 8,00

2752200 - Juego Arandelas de Goma/Jogo Arruelas de Borracha

Gráfico	Descripción/Descrição	Cant./Quant.
○	O' ring 98,02x3,53mm	1
○	O' ring 64,77x2,62mm	1
○	O' ring 56,87x1,78mm	2
○	O' ring 44,12x2,62mm	1
○	O' ring 31,42x2,62mm	2
○	O' ring 23,47x2,62mm	1
○	O' ring 21,89x2,62mm	1
○	O' ring 21x1,5mm	2
○	O' ring 20,30x2,62mm	15
○	O' ring 20x2mm	2
○	O' ring 18,77x1,78mm	2
○	O' ring 17,12x2,62mm	1
○	O' ring 9,25x1,78mm	3

2630500 - Juego Arandelas Metálicas/Jogo Arruelas Metálicas

Gráfico	Descripción/Descrição	Cant./Quant.
○	Arandela 28x37x1,5mm Cobre	1
○	Arandela 22x28x1,5mm Cobre	4
○	Arandela 20x26x1,5mm Cobre	3
○	Arandela 14x18x1,5mm Cobre	4
○	Arandela 12x18x1mm Cobre	4
○	Arandela 10,3x14x1mm Cobre	2
○	Arandela 10x14x1mm Aluminio	1
○	Arandela 9x13x0,5mm Cobre	5



RT-3002Vit
 Retén Bancada
 Ret. Tras. do Virabrequim
 90,00 x 115,00 x 13,00



RT-3000Pol
 Retén Distribución
 Ret. Diant. do Virabrequim
 70,00 x 90,00 x 10,00

Productos relacionados no incluidos en el juego. Los mismos pueden ser solicitados por separado.

Produtos relacionados não incluídos no jogo. Podem ser solicitados em separado.

Related products that were not included in the set but can be ordered separately.



BU-003
 Bulones para
 Culata de Cilindros
 Parafusos de Cabeçote



JV-163
 Juego Caja Velocidad
 Jogo Caixa de Câmbio



RT-9646Vit
 Porta Retén Bancada
 Flange Traseiro
 do Virabrequim



RT-9948Vit
 Porta Retén Bancada
 Flange Traseiro
 do Virabrequim

Juego Completo de Reparación:

Jogo de Juntas do Motor / Full Set Gasket:

R

Semi-Juego de Reparación:

Semi-Jogo de Juntas / Semi-Set Gasket:

SJ-450

R

Juego de Descarbonización:

Jogo de Juntas Superior / Head Set Gasket:

JD-450-ST

R

JUNTA CULATA DE CILINDROS	TC-823 0M	Ø 96.00mm	Δ 1.30mm	± 0.08	de 0,40 a 0,50mm
Junta de cabeçote	TC-823 1M	Ø 96.00mm	Δ 1.40mm	± 0.08	de 0,51 a 0,60mm
Cylinder Head gasket	TC-823 2M	Ø 96.00mm	Δ 1.50mm	± 0.08	de 0,61 a 0,70mm
	TC-823 3M	Ø 96.00mm	Δ 1.60mm	± 0.08	de 0,71 a 0,80mm

DESCRIPCIÓN / Descrição / Description

DIESEL

FIAT: Ducato 14TDS - Ducato Maxi 18TDS 1996/...
IVECO: Turbo Daily 3010 - 3510 - 4010 - 4510 - 4910
 3512 - 4012 - 4512 - 4912 - 5912 1996/...
RENAULT: Master TD 1998/...

MOTOR / Engine	CM ³	HP	Ø PISTON
8140.23	2799	99	94.40
8140.43	2799	122	94.40
S9W 700/702	2799	115	94.40

ILLINOIS

FIAT

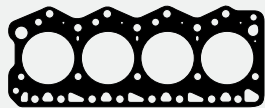

TC-823-20 0M TC-823-MG 0M - 99432354
TC-823-20 1M TC-823-MG 1M - 99432353
TC-823-20 2M TC-823-MG 2M - 99460983
TC-823-20 3M TC-823-MG 3M - 99458402

Junta Culata de Cilindros
Junta Cabeçote

JD-450-ST



1078100 - 98421297
Porta termostato
Porta termostato



2701900
O'ring 9,25 x 1,78mm



1088600
Colector admisión
Coletor admissão

JT-117 Jgo. Turbo



JT-117-01
Junta Turbo
Junta Turbo



JT-117-02
Junta Turbo
Junta Turbo



JAE-412-A - 98425767
Juego Admisión
Jogo Admissão



JAE-413-16 - 98434020
Juego Escape
(Acero inoxidable)
Jogo Escapamento
(Aço inoxidável)



JSA-291
Salida Escape
Saída Escapamento



JVS-268-43 - 98472291
Junta Tapa Válvula Superior
Junta Tampa Válvula Superior



1094900 - 98430478
Junta brida agua
Junta flange água



RT-3003Vit
Jgo. Ret. Guía de Vál.
Jogo Retentor
haste de Válvulas



RT-3001Pol
Retén Árbol de Levas
Ret. do Eixo Comando de Válvulas
50,00 x 70,00 x 10,00



RT-2998Pol
Retén Auxiliar
Retentor Auxiliar
55,00 x 70,00 x 8,00

2626800 - Juego Arandelas Metálicas/Jogo Arruelas Metálicas

Gráfico	Descripción/Descrição	Cant./Quant.
○	Arand./Arruela 14x20x1,5mm Cobre	4
●	Arand./Arruela 12x16x1,5mm Cobre	1
○	Arand./Arruela 10x14x1mm Cobre	6
○	Arand./Arruela 8x14x1mm Cobre	1



JC-356-30 - 99488483
Junta Carter c/limitadores de apriete
Junta Carter c/limitadores de ajuste



1094800
Frente distribución
Frente distribuição



1084900
Tapa block trasera
Tampa bloco traseira



1084200
Tapa cigüeñal del.
Tampa virabrequim dianteira



JC-359-30 - 99488486
Junta Carter c/limitadores de apriete
Junta Carter c/limitadores de ajuste



1084100
Tapa cigüeñal trasera
Tampa virabrequim traseira



1083100
Bomba vacío
Bomba vácuo



1185500
Filtro aceite
Filtro óleo



2729200
Intermedia block derecha
Intermediaria bloco direita



1088700
Com. bomba iny.
Comando bomba injetora



1083500
Filtro aceite
Filtro óleo



1087600
Tapa inspección block
Tampa inspeção bloco



2729300
Intermedia block izquierda
Intermediaria bloco esquerda

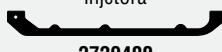

2729400
Intermedia block derecha
Intermediaria bloco direita



1083300
Base filtro aceite
Base filtro óleo



1087300
Entrada aceite
Entrada óleo



2729500
Intermedia block izquierda
Intermediaria bloco esquerda



RT-3002Vit
Retén Bancada
Ret. Tras. do Virabrequim
90,00 x 115,00 x 13,00



RT-3000Pol
Retén Distribución
Ret. Diant. do Virabrequim
70,00 x 90,00 x 10,00

2729100 - Juego Arandelas de Goma/Jogo Arruelas de Borracha

Gráfico	Descripción/Descrição	Cant./Quant.
○	3002230 O'ring 94x3,5mm Inf. Filtro aire	1
○	O'ring 64,77x2,62mm	1
○	46428901 O'ring 59,92x3,53mm	1
○	90353501/056115037 O'ring 56,4 x 1,78mm	1
○	O'ring 55,25x2,62mm	1
○	O'ring 48,9x2,62mm	2
○	O'ring 47,22x3,53mm	3
○	O'ring 44,04x3,53mm	1
○	Guarnición/Guarrição termostato	1
○	O'ring 39,34x2,62mm	1
○	O'ring 29,82x2,62mm	1
○	O'ring 28,24x2,62mm	1
○	O'ring 23x3mm	1
○	O'ring 22,1x3,6mm	2
○	O'ring 21,89x2,62mm	1
○	O'ring 18,64x3,53mm	1
○	O'ring 17x2,2mm	6
○	O'ring 12,37x2,62mm	1

2626700 - Juego Arandelas Metálicas/Jogo Arruelas Metálicas

Gráfico	Descripción/Descrição	Cant./Quant.
○	Arand./Arruela 22x27x1,5mm Cobre	1
○	Arand./Arruela 18x22x1,5mm Cobre	1
○	Arand./Arruela 16x20x1,5mm Cobre	6
○	Arand./Arruela 14x20x1,5mm Cobre	6
○	Arand./Arruela 12x18x1,5mm Cobre	1
○	Arand./Arruela 12x17x1,5mm Cobre	5
○	Arand./Arruela 8x14x1mm Cobre	4
○	Arand./Arruela 7x13x1,5mm Cobre	1

Productos relacionados no incluidos en el juego. Los mismos pueden ser solicitados por separado.

Produtos relacionados não incluídos no jogo. Podem ser solicitados em separado.

Related products that were not included in the set but can be ordered separately.



BU-003 BU-213
Bulones p/Culata de Cil.
Parafusos de Cabeçote



JV-163
Juego Caja Velocidad
Jogo Caixa de Câmbio



RT-9646Vit
Porta Retén Bancada
Flange Tras. do Virabrequim
.../1996 A 272-H 114,00



RT-9948Vit
Porta Retén Bancada
Flange Tras. do Virab.
1996/...A 272-H 114,00



JSA-325-21
Salida Escape
Saída Escapamento
(malla ac./malha aço)

DESCRIPCIÓN / Descrição / Description **DIESEL**

FIAT: Ducato 14 - Ducato 18 Maxi
 Ducato 14D - Ducato 18D Maxi 1998/...
IVECO: Daily 30.8 - 35.8 1996/...

MOTOR / Engine	CM ³	HP	Ø PISTON
8140.63	2799	87/89	94.40
Inyección Indirecta			

Juego Completo de Reparación:

Jogo de Juntas do Motor / Full Set Gasket:

Semi-Juego de Reparación:

Semi-Jogo de Juntas / Semi-Set Gasket:

SJ-526

R

Juego de Descarbonización:

Jogo de Juntas Superior / Head Set Gasket:

JD-526-ST

R

JUNTA CULATA DE CILINDROS	TC-898-20 0M	Ø 96.30mm	1.70mm
Junta de cabeçote	TC-898-20 1M	Ø 96.30mm	1.80mm
Cylinder Head gasket	TC-898-20 2M	Ø 96.30mm	1.90mm



JD-526-ST

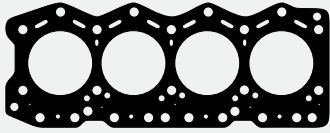

TC-898-20 0M - 500206171
TC-898-20 1M - 500206171
TC-898-20 2M - 500206171
 Junta Culata de Cilindros
 Junta Cabeçote



JAE-412-A - 98425767
 Juego Admisión
 Jogo Admissão



1122000
 Brida turbo
 Flange turbo



1126400
 Salida escape turbo
 Saída escapamento turbo



1094900 - 98430478
 Brida agua
 Brida água



JAE-413-16 - 98434020
 Juego Escape (Acero inoxidable)
 Jogo Escapamento (Aço inoxidável)



1078100 - 98421297
 Porta termostato
 Porta termostato



1088600
 Colector admisión
 Coletor admissão



JVS-265-43 - 500388381
 Junta Tapa Válvula Superior
 Junta Tapa Válvula Superior



RT-3003Vit
 Jgo. Ret. Guía de Vál.
 Jogo Retentor da Haste de Válvulas



RT-3001Pol
 Retén Árbol de Levas
 Retentor do Eixo Comando de Válvulas
 50,00 x 70,00 x 10,00



RT-2998Pol
 Retén Auxiliar
 Retentor Auxiliar
 55,00 x 70,00 x 8,00

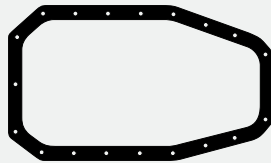

JC-356-30 - 99488483
 Junta Cártér c/limitadores de apriete
 Junta Carter c/limitadores de ajuste



1100000
 Tapa ciega insp. precámara
 Tampa cega inspeção pré-câmara



1088700 - 98430444
 Comando bomba inyectora
 Comando bomba injetor



JC-359-30 - 99488486
 Junta Cártér c/limitadores de apriete
 Junta Carter c/limitadores de ajuste



1094800
 Frente distribución
 Frente distribuição



1087600
 Tapa inspección block
 Tampa inspeção bloco



2729400
 Intermedia block derecha
 Intermediária bloco direita



1083100
 Bomba de vacío
 Bomba de vácuo



1083300
 Base filtro aceite
 Base filtro óleo



2729500
 Intermedia block izquierda
 Intermediária bloco esquerda



1118800
 Junta
 Junta



RT-3002Vit
 Retén Bancada
 Ret. Tras. do Virabrequim
 90,00 x 115,00 x 13,00



RT-3000Pol
 Retén Distribución
 Ret. Diant. do Virabrequim
 70,00 x 90,00 x 10,00

2629800 - Juego Arandelas Metálicas/Jogo Arruelas Metálicas

Gráfico	Descripción/Descrição	Cant./Quant.
○	Arand./Arruela 22x27x1,5mm Cobre	2
○	Arand./Arruela 20x26x1mm Cobre	2
○	Arand./Arruela 18x22x1,5mm Cobre	2
○	Arand./Arruela 14x20x1,5mm Cobre	2
○	Arand./Arruela 12x18x1,5mm Cobre	10
○	Arand./Arruela 10x14x1mm Cobre	4
○	Arand./Arruela 8x14x1mm Cobre	5

2748300 - Juego Arandelas de Goma/Jogo Arruelas de Borracha

Gráfico	Descripción/Descrição	Cant./Quant.
○	O'ring 94,62x5,33mm	1
○	O'ring 64,77x2,62mm	1
○	O'ring 59,92x3,53mm	1
○	O'ring 56,87x1,78mm	1
○	O'ring 55,25x2,62mm	1
○	O'ring 48,90x2,62mm	1
○	O'ring 47,22x3,53mm	2
○	O'ring 44,04x3,53mm	1
○	O'ring 37,47x5,33mm	1
○	O'ring 29,82x2,62mm	1
○	O'ring 23,47x2,62mm	1
○	O'ring 21,95x1,78mm	1
○	O'ring 18,72x2,62mm	2
○	O'ring 18,64x3,53mm	1
○	O'ring 17,17x1,78mm	4
○	O'ring 12,37x2,62mm	1
○	O'ring 9,25x1,78mm	4
○	Guarnición/Guarnição termostato	1

Productos relacionados no incluidos en el juego. Los mismos pueden ser solicitados por separado.

Produtos relacionados não incluídos no jogo. Podem ser solicitados em separado.

Related products that were not included in the set but can be ordered separately.



BU-213
 Bulones para Culata de Cilindros
 Parafusos de Cabeçote



JV-163
 Jgo. Caja Vel.
 Jogo Caixa de Câmbio



RT-9646Vit
 Porta Ret. Bancada
 Flange Traseiro do Virabrequim



RT-9948Vit
 Porta Retén Bancada
 Flange Traseiro do Virabrequim

Juego Completo de Reparación:

Jogo de Juntas do Motor / Full Set Gasket:

Semi-Juego de Reparación:

Semi-Jogo de Juntas / Semi-Set Gasket:

Juego de Descarbonización:

Jogo de Juntas Superior / Head Set Gasket:

JUNTA CULATA DE CILINDROS	TC-922 1M	∅ 97.00mm	1.20mm	±0.05
Junta de cabeçote	TC-922 2M	∅ 97.00mm	1.30mm	±0.05
Cylinder Head gasket	TC-922 3M	∅ 97.00mm	1.40mm	±0.05

JD-598-ST

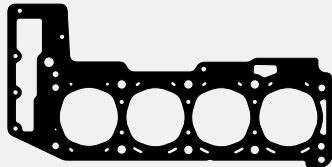

TC-922-20 1M TC-922-MG 1M - 504093499
 TC-922-20 2M TC-922-MG 2M - 504093499
 TC-922-20 3M TC-922-MG 3M - 504093499
 Junta Culata de Cilindros
 Junta Cabeçote

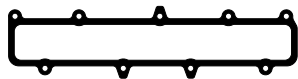

JAE-578-A - 504047974 / 0348T7
 Juego Admisión
 Jogo Admissão

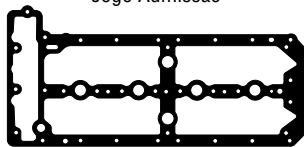

JVS-386-15 - 504161187 / 0249F7
 Junta Tapa Válvula Superior
 Junta Tampa Válvula Superior



1084700 - 504090524
 Junta termostato
 Junta termostato



1101600
 Junta cuerpo mariposa
 Junta corpo borboleta



JAE-579-E - 504022754/0349L8
 Juego Escape (Acero inoxidable)
 Jogo Escapamento (Aço inoxidável)



JSA-319 - 1350860080
 Salida Escape
 Saída Escapamento



1096100
 Junta cabezal TC
 Junta cabeça cabeçote



2767800
 Junta tapa delantera
 Junta tampa dianteira



1087300
 Junta Turbo



1122000
 Junta



1100900
 Junta válvula EGR



JSA-320
 Salida Escape
 Saída Escapamento

2777900 - Jgo. Arandelas Goma/Jogo Arruelas Borracha

Gráfico	Descripción/Descrição	Cant./Quant.
	O' Ring 34,59 x 2,62mm	1
	O' Ring 32,99 x 2,62mm	1
	O' Ring 23,47 x 2,62mm	1
	O' Ring 9,25 x 1,78mm	2



JC-399-43 - 504083813
 Junta Cáster
 Junta Carter

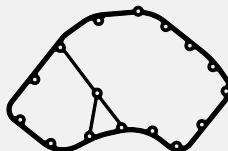

1069400
 Junta tapa distribución
 Junta tampa distribuição



1069800
 Junta intercambiador de calor
 Junta intertrocador de calor



1083600
 Junta bomba de aceite
 Junta bomba de óleo



1084800
 Junta bomba de agua
 Junta bomba de água



1069700
 Junta intercambiador de calor
 Junta intertrocador de calor



2706200
 O' Ring 94 x 3mm



2609600
 Arandela de aluminio
 Arruela de aluminio



1101900
 Junta



2638000
 Arandela blindada de cobre
 Arruela blindada de cobre



2750700
 Filtro de combustible
 Filtro de combustível



1101800
 Junta

Productos relacionados no incluidos en el juego. Los mismos pueden ser solicitados por separado.

Produtos relacionados não incluídos no jogo. Podem ser solicitados em separado.

Related products that were not included in the set but can be ordered separately.

DESCRIPCIÓN / Descrição / Description

DIESEL

FIAT: Ducato JTD Multijet 2006/...
 IVECO: Daily III/V 2006/...
 CITROEN: Jumper III HDI 2008/...
 PEUGEOT: Boxer Manager HDI 2006/...

MOTOR / Engine	CM ³	HP	∅ PISTON
F1CE0481/A/D (30DT)	2999	136/156	95.80
F30DT/FG30DT 16V	2999	156	94.40

ILLINOIS

FIAT



DESCRIPCIÓN / Descrição / Description

FORD: Escort 1.3 1983/...
 Escort Hobby 1.0 1993/...
VOLKSWAGEN: Gol 1993/...

MOTOR / Engine	CM ³	HP	Ø PISTON
CHT/AE	997		70.30
CHT/AE	1300		71.30

Juego Completo de Reparación:

Jogo de Juntas do Motor / Full Set Gasket:

JR-490-15



Semi-Juego de Reparación:

Semi-Jogo de Juntas / Semi-Set Gasket:

SJ-490



Juego de Descarbonización:

Jogo de Juntas Superior / Head Set Gasket:

JD-490-15



JUNTA CULATA DE CILINDROS	TC-719-15	Ø 73.30mm	1.50mm	↑ ↓
Junta de cabeçote				↑ ↓
Cylinder Head gasket				↑ ↓



JD-490-15

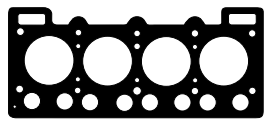

TC-719-15 - 84AU6051C
 Junta Culata de Cilindros
 Junta Cabeçote



JSA-195 - 85AU9451A
 84AV9451A
 Salida Escape
 Saída Escapamento



JSA-185 - 843253115B
 Salida Escape
 Saída Escapamento



JAE-347 - 84AU9448C
 Múltiple Admisión y Escape
 Coletor Admissão e Escapamento



1129400 - 84AU6W021A
 Bomba de agua
 Bomba de água



1128300 - 029121041/1
 84AV8513
 Bomba de agua
 Bomba de água



1129500 - 86AU8507A
 Bomba de agua
 Bomba de água



JVS-240-43 - BD1M6584A/7702220551
 Junta Tapa Válvula Superior
 c/arrandelas
 Junta Tampa Válvula Superior
 c/arruelas



1128400 - BDSM6417
 Entre múltiple escape
 Entre múltiplo escapamento



1112000
 Base bomba de agua
 Base bomba de água



RT-556PoI
 Juego Retenes
 Guia de Válvulas
 Jogo Retentor da Haste
 de Válvulas



JC-291-30 - A84SU6781A
 Junta Cártier
 Junta Carter



1121500 - 78MU6055A
 Suplemento camisa
 Suplemento camisa



1129000 - 0857726400
 78MU6659A
 Bomba de aceite
 Bomba de óleo



1109400 - 0607155700
 Base distribuidor
 Base distribuidor



1129100 - 7DBA2026A/73MU6020A
 Distribución
 Distribuição



1129200 - 75MU9417A
 Bomba de nafta
 Bomba de gasolina



RT-8087Vit
 Retén Bancada Lx-Hel
 Ret. Traseiro do Virabrequim
 82,00 x 105,00 x 12,00



RT-8006PoI
 Retén Distribución A 156-R
 Ret. Dianteiro do Virabrequim
 35,00 x 50,00 x 10,00



2605700
 Arandela 14 x 20 x 2mm
 Arruela (Cobre)

Productos relacionados no incluidos en el juego. Los mismos pueden ser solicitados por separado.

Produtos relacionados não incluídos no jogo. Podem ser solicitados em separado.

Related products that were not included in the set but can be ordered separately.



BU-038
 Bulones para
 Culata de Cilindros
 Parafusos de Cabeçote



JC-291-23
 Junta Cártier
 Junta Carter



JSA-185-11
 841253115B
 Salida Escape
 Saída Escapamento

Juego Completo de Reparación:

Jogo de Juntas do Motor / Full Set Gasket:

JR-758-07**Semi-Juego de Reparación:**

Semi-Jogo de Juntas / Semi-Set Gasket:

Juego de Descarbonización:

Jogo de Juntas Superior / Head Set Gasket:

JUNTA CULATA DE CILINDROS	TC-800-07	∅ 73.00mm	1.50mm	↑ ↓
Junta de cabeçote				↑ ↓
Cylinder Head gasket				↑ ↓

DESCRIPCIÓN / Descrição / Description

FORD: Ka - Ka+ - Fiesta 2014/...

MOTOR / Engine

CM³

HP

∅ PISTON

M1DA TiVCT 12V
Ecoboost

998

100

71.90

ILLINOIS.

■ FORD

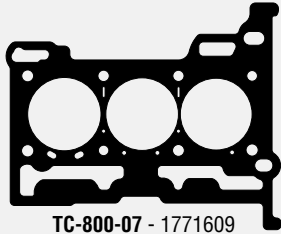

TC-800-07 - 1771609
Junta Culata de Cilindros
Junta Cabeçote

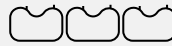

JAE-613-A
JuegoAdmisión
Jogo Admissão

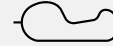

2778100
Junta

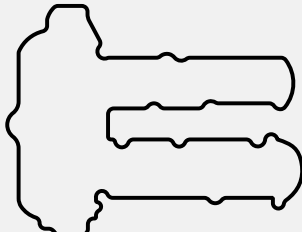

JVS-405-43 - 1799829
Junta Tapa Válvula Superior
Junta Tampa Válvula Superior



JAE-631-E
Junta Escape
Junta Escapamento



2778000
Conexión bomba de agua
Conexão bomba de água



1403800
1760680/CM5G8507AA
Bomba de agua
Bomba de água



JSA-341
1140134/1146867/1309484/2S619451AC
Salida Escape
Saída Escapamento



1403700
Bomba de vacío
Bomba de vácuo

Productos relacionados no incluidos en el juego. Los mismos pueden ser solicitados por separado.

Produtos relacionados não incluídos no jogo. Podem ser solicitados em separado.

Related products that were not included in the set but can be ordered separately.

DESCRIPCIÓN / Descrição / Description

**FORD: Ka - Fiesta - Courier - Escort
Ecosport 8V 1999/...**

MOTOR / Engine	CM ³	HP	Ø PISTON
Zetec Rocam ZL	999	65/95	68.69

Juego Completo de Reparación:

Jogo de Juntas do Motor / Full Set Gasket:

JR-388



Semi-Juego de Reparación:

Semi-Jogo de Juntas / Semi-Set Gasket:

SJ-388



Juego de Descarbonización:

Jogo de Juntas Superior / Head Set Gasket:

JD-388



JUNTA CULATA DE CILINDROS	TC-727-15	Ø 70.00mm	1.50mm	±0.05
Junta de cabeçote	TC-727-MG	Ø 70.00mm	1.30mm	±0.05
Cylinder Head gasket	TC-727-18	Ø 70.00mm	2.50mm	±0.05



JD-388



TC-727 - XS6E6051AC
Junta Culata de Cilindros
Junta Cabeçote



2714200 - 958F9F670BB
Guarnición válvula de gases
válvula IAC
Guarnição válvula de gases



2714100 - XS6E9P848AA
Guarnición válvula mariposa de gases
Guarnição válvula borboleta de gases



JAE-478-A - XS6E9441BA
Juego Admisión
Jogo Admissão



JAE-476-E - XS6E9448AC
Junta Escape
Junta Escapamento



2713900 - XS6E8255BB
Carcasa termostato
Carça termostato

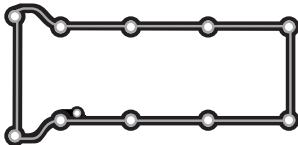

JVS-303-43 - XS6E6584AB/6710A2B
Junta Tapa Válvula Superior
Junta Tampa Válvula Superior



2714000 - XS6E6K780AC
Guarnición salida de gases
Guarnição saída de gases



2714300
O'ring 47,22 x 3,53mm



RT-2993PoI
Juego Retenes Guía de Válvulas
Jogo Retentor da Haste de Válvulas



JC-338-43 - XS6E6710A2B
Junta Carter (Goma-Metal)
Junta Carter (Borracha-Metal)



1140700 - XS6E6659A2B
Bomba de aceite
Bomba de óleo



1140800 - XS6E6L6221AD
Soporte filtro aceite
Suporte filtro óleo



RT-9826Vit
Retén Distribución
Retentor Dianteiro do Virabrequim
Lx-R 39,95 x 62,00 x 7,40

Productos relacionados no incluidos en el juego. Los mismos pueden ser solicitados por separado.

Produtos relacionados não incluídos no jogo. Podem ser solicitados em separado.

Related products that were not included in the set but can be ordered separately.



BU-022
Bulones para Culata de Cilindros
Parafusos de Cabeçote



BU-241
Bulones p/Culata de Cil. c/ Fijación Tapa de Válvula
Parafusos de Cabeçote c/Fixação Tampa de Válvula



RT-9946Tef
Porta Retén Bancada
Flange Traseiro do Virabrequim
A 352-R 79,00

Juego Completo de Reparación:

Jogo de Juntas do Motor / Full Set Gasket:

JR-523-15**Semi-Juego de Reparación:**

Semi-Jogo de Juntas / Semi-Set Gasket:

SJ-267**Juego de Descarbonización:**

Jogo de Juntas Superior / Head Set Gasket:

JD-523-15

JUNTA CULATA DE CILINDROS	TC-897-15	Ø 70.50mm	1.50mm	↑ ↓
Junta de cabeçote				↑ ↓
Cylinder Head gasket				↑ ↓

DESCRIPCIÓN / Descrição / Description

FORD: Ka 1997/99 - Fiesta 1996/99 53 HP
Fiesta 1988/95 45 HP

MOTOR / Engine	CM ³	HP	Ø PISTON
OHV (HCS)	999	45/53	68.70
Endura			

ILLINOIS

FORD

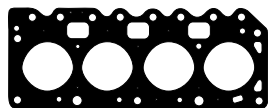
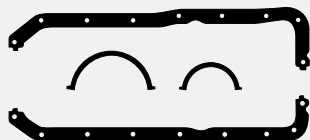
**JD-523-15****TC-897-15** - 1012728-89BM6051B1D
1020808-89MB6051B2C
Junta Culata de Cilindros
Junta Cabeçote**1162800** - 84BF8255AA/1628164
Termostato
Termostato**JAE-375-A** - 6173339
Junta Admisión
Junta Admissão**JAE-487-A**
Junta Admisión
Junta Admissão**JAE-374-E** - 95BM9448AC/7126483
Juego Escape
Jogo Escapamento**JVS-255-30** - 96BM6584A2A/6038115
Junta Tapa Válvula Superior
Junta Tampa Válvula Superior**JSA-204** - 92BB9451AA
1628164/6175938
Salida Escape
Saída Escapamento**RT-556Pol**
Juego Retenes Guía de Válvulas
Jogo Ret. da Haste de Válvulas**JC-303-30** - 89BM6344BA/6707927
Junta Cártér
Junta Carter**1162600** - 89BM8507AA/6165295
Tapa distribución
Tampa distribuição**1162900** - 89BM6020AA/6165221
Bancada trasera
Traseira do Virabrequim**1162700** - 96BM6659A1A/6189107
Bomba de agua
Bomba de água**2728100**
O'ring 23 x 3mm bomba de aceite
bomba de óleo**1163000** - 96BM6659A1A/1651769
Bomba de aceite
Bomba de óleo**2611100**
Arandela tapón cárter
Arruela tampão carter
15 x 21 x 2mm (Aluminio)**RT-8009Pol**
Retén Bancada
Retentor Traseiro do Virabrequim
Mx-R 79,00 x 95,25 x 11,11**RT-9268Pol**
Retén Distribución
Retentor Dianteiro do Virabrequim
A 161-R 36,60 x 52,35 x 8,00**2748100**
O'ring 23,5 x 1,8mm
bomba de nafta
bomba de gasolina

Productos relacionados no incluidos en el juego. Los mismos pueden ser solicitados por separado.

Produtos relacionados não incluídos no jogo. Podem ser solicitados em separado.

Related products that were not included in the set but can be ordered separately.

**BU-013**
Bulones para
Culata de Cilindros
Parafusos de Cabeçote**JC-385-43**
Junta Cártér
Junta Carter

DESCRIPCIÓN / Descrição / Description

FORD: Fiesta 2003/... - Ecosport 2003/...

MOTOR / Engine	CM ³	HP	Ø PISTON
Zetec Rocam Supercharger	999	98	68.70

Juego Completo de Reparación:

Jogo de Juntas do Motor / Full Set Gasket:

JR-565

R

Semi-Juego de Reparación:

Semi-Jogo de Juntas / Semi-Set Gasket:

SJ-565

R

Juego de Descarbonización:

Jogo de Juntas Superior / Head Set Gasket:

JD-565

R

JUNTA CULATA DE CILINDROS	TC-727-15	Ø 70.00mm	1.50mm	±0.05
Junta de cabeçote	TC-727-MG	Ø 70.00mm	1.30mm	±0.05
Cylinder Head gasket	TC-727-18	Ø 70.00mm	2.50mm	±0.05



JD-565



TC-727 - XS6E6051AC
Junta Culata de Cilindros
Junta Cabeçote



2714200 - 958F9F670BB
Guarnición válvula de gases
Guarnição válvula de gases
válvula IAC



2714100 - XS6E9P848AA
Guarnición válvula mariposa de gases
Guarnição válvula borboleta de gases



JAE-632-A - 2N1U9441BB
Juego Admisión
Jogo Admissão



JAE-633-E - 1212813/2S6G9448AD
Junta Escape
Junta Escapamento



2713900 - XS6E8255BB
Carcasa termostato
Carcaça termostato

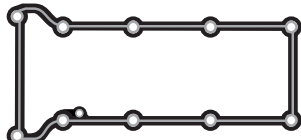

JVS-303-43 - XS6E6584AB/6710A2B
Junta Tapa Válvula Superior
Junta Tampa Válvula Superior



2714000 - XS6E6K780AC
Guarnición salida de gases
Guarnição saída de gases



2714300
O'ring 47,22 x 3,53mm



RT-2993Pol
Juego Retenes Guía de Válvulas
Jogo Retentor da Haste de Válvulas



JC-338-43 - XS6E6710A2B
Junta Carter (Goma-Metal)
Junta Carter (Borracha-Metal)



1140700 - XS6E6659A2B
Bomba de aceite
Bomba de óleo



1140800 - XS6E6L6221AD
Soporte filtro aceite
Suporte filtro óleo



RT-9826Vit
Retén Distribución
Ret. Dianteiro do Virabrequim
Lx-R 39,95 x 62,00 x 7,40

Productos relacionados no incluidos en el juego. Los mismos pueden ser solicitados por separado.

Produtos relacionados não incluídos no jogo. Podem ser solicitados em separado.

Related products that were not included in the set but can be ordered separately.



BU-022
Bulones para Culata de Cilindros
Parafusos de Cabeçote



BU-241
Bulones p/Culata de Cil. c/ Fijación Tapa de Válvula
Parafusos de Cabeçote c/Fixação Tampa de Válvula



RT-9946Tef
Porta Retén Bancada
Flange Traseiro do Virabrequim
A 352-R 79,00

Juego Completo de Reparación:

Jogo de Juntas do Motor / Full Set Gasket:

JR-356-15**Semi-Juego de Reparación:**

Semi-Jogo de Juntas / Semi-Set Gasket:

SJ-267**Juego de Descarbonización:**

Jogo de Juntas Superior / Head Set Gasket:

JD-169-15

JUNTA CULATA DE CILINDROS	TC-596-15	∅ 76.00mm	1.50mm	↑ ↓
Junta de cabeçote				↑ ↓
Cylinder Head gasket				↑ ↓

DESCRIPCIÓN / Descrição / Description

FORD: Fiesta 1988/95 - Courier 1991/...

Fiesta - Ka (Cárter de Acero)

(Cárter de Aluminio 1995/...)

MOTOR / Engine

CM³

HP

∅ PISTON

OHV (HCS)

1297

60

73.96

Endura

1299

50/60

73.96

ILLINOIS

FORD

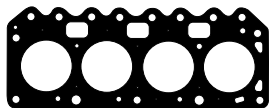
**JD-169-15**

TC-596-15 - 6176727/75-1000389
89BM6051C1C/C2B - 96BM6051A1A/A2A
Junta Culata de Cilindros
Junta Cabeçote



1162800 - 84BF8255AA/1628164
Termostato



JAE-375-A - 6173339
Junta Admisión 1988/95
Junta Admissão 1988/95



JAE-487-A
Junta Admisión 1995/...
Junta Admissão 1995/...



JAE-374-E - 95BM9448AC/7126483
Juego Escape
Jogo Escapamento



JVS-255-30 - 96BM6584A1A/6038115
Junta Tapa Válvula Superior
Junta Tampa Válvula Superior



JSA-204 - 92BB9451AA/1628164/6175938
Salida Escape
Saída Escapamento



RT-556PoI
Juego Retenes Guía de Válvulas
Jgo. Retentor da Haste de Válvulas

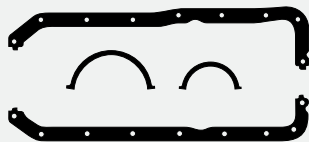

JC-303-30 - 89BM6344BA/6707927
Junta Cárter
Junta Carter

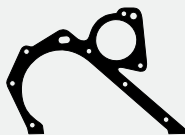

1162600 - 89BM8507AA/6165295
Tapa distribución
Tampa distribuição



1162900 - 89BM6020AA/6165221
Bancada trasera
Mancal traseira



1162700 - 96BM6659A1A/6189107
Bomba de agua
Bomba de água



2728100
O'ring 23 x 3mm
bomba de aceite
bomba de óleo



1163000 - 96BM6659A1A/1651769
Bomba de aceite
Bomba de óleo



2611100
Arandela tapón cárter
Arruela tampão carter
15 x 21 x 2mm (Aluminio)



2748100
O'ring 23,5 x 1,8mm
bomba de nafta
bomba de gasolina



RT-8009PoI
Retén Bancada
Retentor Traseiro do Virabrequim
Mx-R 79,00 x 95,25 x 11,11



RT-9268PoI
Retén Distribución
Retentor Dianteiro do Virabrequim
A 161-R 36,60 x 52,35 x 8,00

Productos relacionados no incluidos en el juego. Los mismos pueden ser solicitados por separado.

Produtos relacionados não incluídos no jogo. Podem ser solicitados em separado.

Related products that were not included in the set but can be ordered separately.



BU-013
Bulones para Culata de Cilindros
Parafusos de Cabeçote

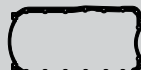

JC-385-43
Junta Cárter
Junta Carter

DESCRIPCIÓN / Descrição / Description			
FORD: Corcel 1971/77 - Corcel II 1978/83 Belina - Coupe GT 1.4 BR			
MOTOR / Engine	CM ³	HP	Ø PISTON
CHT	1300	73	77.00
CHT	1400	73	77.00

Juego Completo de Reparación: Jogo de Juntas do Motor / Full Set Gasket:	JR-316-15	R		
Semi-Juego de Reparación: Semi-Jogo de Juntas / Semi-Set Gasket:	SJ-316	R		
Juego de Descarbonización: Jogo de Juntas Superior / Head Set Gasket:	JD-316-15	R		
JUNTA CULATA DE CILINDROS Junta de cabeçote Cylinder Head gasket	TC-465-15	Ø 78.00mm	1.40mm	



JD-316-15

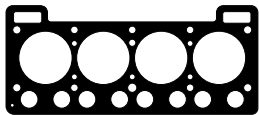

TC-465-15 - 78MU6051A2
Junta Culata de Cilindros
Junta Cabeçote



1077200 - 0607332300
Base carburador
Base carburador



1003000 - 48470
Placa bomba de agua
Placa bomba água



1003200
Base carburador
Base carburador



JVS-240-43 - BD1M6584A
7702220551/64293
Junta Tapa Válvula Superior c/arruelas
Junta Tampa Válvula Superior
c/arruelas



JAE-389 - 48262
Múltiple Admisión y Escape
Coletor Admissão e Escapamento



1003500 - 48469
Tapa trasera tapa de cilindros
Tampa traseira cabeçote



JSA-132 - C6AZ9450D
7ZAU9451A/3696990
Salida Escape
Saída Escapamento



JC-370-30 - 85958
Junta Carter
Junta Carter



1002900 - 48437
Bomba de agua
Bomba de água



1077100 - 0602349600
7702023292/BDIM9417A
Bomba de nafta
Bomba de gasolina

RT-556Pol
Juego Retenes
Guía de Válvulas
Jogo Retentor da Haste
de Válvulas



1129100 - 7DBA2026A
73MU6020A
Distribución
Distribuição



1003100 - 65689
Bomba de aceite
Bomba de óleo



1129300 - 78MU6659A
Bomba de aceite
Bomba de óleo



2632100 - 17138
Arandela tapón cárter
Arruela tampão carter
19 x 24 x 1,5mm
(Aluminio)



1129200
Bomba de nafta
Bomba de gasolina



1003300 - 75MU9417A
BD5M9417A
Bomba de nafta
Bomba de gasolina



1129000 - 65689
Bomba de aceite
Bomba de óleo



1109400 - 0607155700
Base distribuidor
Base distribuidor

RT-8087Vit
Retén Bancada Lx-Hel
Ret. Traseiro do Virabrequim
82,00 x 105,00 x 12,00

RT-8006Pol
Retén Distribución A 156-R
Ret. Dianteiro do Virabrequim
35,00 x 50,00 x 10,00

Productos relacionados no incluidos en el juego. Los mismos pueden ser solicitados por separado.
Produtos relacionados não incluídos no jogo. Podem ser solicitados em separado.
Related products that were not included in the set but can be ordered separately.

Juego Completo de Reparación:

Jogo de Juntas do Motor / Full Set Gasket:

JR-535-15**Semi-Juego de Reparación:**

Semi-Jogo de Juntas / Semi-Set Gasket:

SJ-535**Juego de Descarbonización:**

Jogo de Juntas Superior / Head Set Gasket:

JD-535-15

JUNTA CULATA DE CILINDROS	TC-906-15	∅ 77.00mm	1.50mm	↑ ↓
Junta de cabeçote	TC-906-MG	∅ 77.00mm <td>1.50mm <th>↑ ↓</th> </td>	1.50mm <th>↑ ↓</th>	↑ ↓
Cylinder Head gasket	TC-906-11	∅ 77.00mm <td>1.50mm <th>↑ ↓</th> </td>	1.50mm <th>↑ ↓</th>	↑ ↓
		∅		↑ ↓

DESCRIPCIÓN / Descrição / Description

FORD: Fiesta SE - Courier - Puma 1996/...
Focus 1998/...

MOTOR / Engine	CM ³	HP	∅ PISTON
Zetec SE 16V	1388	90/75	76.00

ILLINOIS

FORD

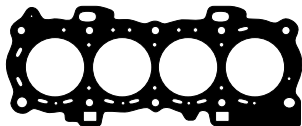
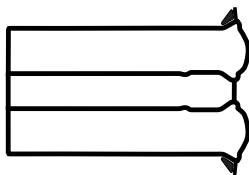
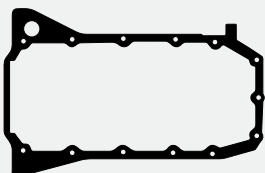
**JD-535-15****TC-906-15**
Junta Culata de Cilindros
Junta Cabeçote**1009100** - 1018250
Termostato
Termostato**2751600**
Válvula IAC
Válvula IAC**JVS-339-43** - 1072018/1072160
98MM6M293AC/BC
Junta Tapa Válvula Superior
Junta Tampa Válvula Superior**JAE-531-E** - 1072066/1004464/1031021
1E0513460A/96MM9448BB/AB
Junta Escape
Junta Escapamento**JAE-530-A** - 1004476/96MM9441AD
1072063/DI347901
Juego Admisión
Jogo Admissão**JC-384-15** - 1004459/96MM6710AD
Junta Cáster
Junta Carter**2751700**
Cuerpo mariposa
Corpo borboleta**RT-9649Vit**
Retén Árbol de Levas
Ret. do Eixo Comando de Válv.
Lx-R 38,00 x 52,00 x 6,00**1009300** - 1007715
Bomba de agua
Bomba de água**1009200** - 1004452/1107165
Tapa distribución
Tampa distribuição**2763900**
Junta**2610200** - 1663816
Arandela 15 x 21 x 1,5mm
Arruela (Aluminio)**2751800**
Termostato**RT-9648Vit**
Retén Distribución
Retentor Dianteiro do Virabrequim
Lx-R 33,00 x 47,00 x 5,00

Productos relacionados no incluidos en el juego. Los mismos pueden ser solicitados por separado.

Produtos relacionados não incluídos no jogo. Podem ser solicitados em separado.

Related products that were not included in the set but can be ordered separately.

**BU-012**
Bulones para Culata de Cilindros
Parafusos de Cabeçote**JC-384-43**
Junta Cáster
Junta Carter**RT-1144Tef**
Porta Reten Bancada
Flange Traseiro do Virabrequim
80,00 x 96,5/168,00 x 10,00

DESCRIPCIÓN / Descrição / Description **DIESEL**

FORD: Fiesta - EcoSport TD 2003/...
Duratorq TDCI 1996/98 - Fusion TDCI 2001/...
CITROEN: C3 - C2 HDI - C1 - Xsara HDI 2002/...
PEUGEOT: 107 - 206 - 307 - 1007
 Bipper HDI 2001/...

MOTOR / Engine	CM ³	HP	Ø PISTON
F6JA - F6JB	1398	68	73.70
DV4TD(8HX)	1398	54/70	73.70
DV4TD(8HZ)	1398	68	73.70
(SOHC) 8V DURATORQ	1398	68	73.70

Juego Completo de Reparación:

Jogo de Juntas do Motor / Full Set Gasket:

Semi-Juego de Reparación:

Semi-Jogo de Juntas / Semi-Set Gasket:

SJ-542

R

Juego de Descarbonización:

Jogo de Juntas Superior / Head Set Gasket:

JD-542-ST

R

JUNTA CULATA DE CILINDROS	TC-885 1M	Ø 75.00mm	1.25mm	de 0,61 a 0,72mm
Junta de cabeçote Cylinder Head gasket	TC-885 2M	Ø 75.00mm	1.35mm	de 0,73 a 0,77mm
	TC-885 3M	Ø 75.00mm	1.40mm	de 0,78 a 0,82mm
	TC-885 4M	Ø 75.00mm	1.45mm	de 0,83 a 0,87mm
	TC-885 5M	Ø 75.00mm	1.50mm	de 0,88 a 0,98mm
		Ø		

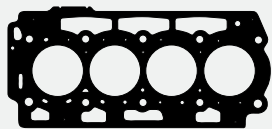

TC-885-20 1M TC-885-MG 1M
 TC-885-20 2M TC-885-MG 2M
 TC-885-20 3M TC-885-MG 3M
 TC-885-20 4M TC-885-MG 4M
 TC-885-20 5M TC-885-MG 5M

1146049
 Junta Culata de Cilindros
 Junta Cabeçote

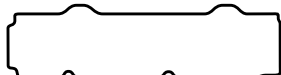

JVS-309-43 - 1148101
 Junta Tapa Válvula Superior
 Junta Tampa Válvula Superior



JC-358-34 - 12232358/1
 Junta Carter
 Junta Carter



2730000 - 1145944
 Juego anillo refrigerador de aceite
 Jogo anel refrigerador de óleo



2730300 - 7701049890
 Chupador bomba de aceite
 Pescador bomba óleo



2725100 - 1145938
 Anillo rectangular bomba de aceite
 Anel retangular bomba óleo



RT-8573Pol
 Retén Distribución
 Retenedor Dianteiro do Virabrequim
 A 156-R 40,00 x 55,00 x 8,00



RT-9196Vit
 Retén Bancada
 Retenedor Traseiro do Virabrequim
 Lx-R 85,00 x 105,00 x 8,00

JD-542-ST



2748200
 O'ring 34,4 x 3,2mm



2730400
 O'ring 43 x 3,7mm



JAE-512-A - 1148106
 Juego Admisión
 Jogo Admissão

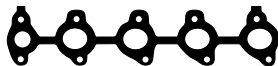

JAE-511-E - 1152194/0349V8
 Múltiple Escape
 Coletor Escapamento



1005800
 Bomba de agua
 Bomba de água



RT-898Vit
 Juego Retenes Guía de Válvulas
 Jogo Retenedor da Haste de Válvulas



RT-9910Vit
 Retén Árbol de Levas
 Retenedor do Eixo Comando de Válvulas
 Lx-R 27,00 x 47,00 x 7,00

Productos relacionados no incluidos en el juego. Los mismos pueden ser solicitados por separado.

Produtos relacionados não incluídos no jogo. Podem ser solicitados em separado.

Related products that were not included in the set but can be ordered separately.



BU-120
 Bulones para Culata de Cilindros
 Parafusos de Cabeçote



JT-124
 Juego Turbo
 Jogo Turbo

Juego Completo de Reparación:

Jogo de Juntas do Motor / Full Set Gasket:

JR-308-15**Semi-Juego de Reparación:**

Semi-Jogo de Juntas / Semi-Set Gasket:

SJ-308**Juego de Descarbonización:**

Jogo de Juntas Superior / Head Set Gasket:

JD-308-15

JUNTA CULATA DE CILINDROS	TC-465-15	∅ 78.00mm	1.50mm	↑ ↓
Junta de cabeçote				↑ ↓
Cylinder Head gasket				↑ ↓

DESCRIPCIÓN / Descrição / Description

FORD: Corcel II 1979/83 - Scala 1983/...
Pampa 1982/83 - Del Rey 1981/83 - Belina II

MOTOR / Engine	CM ³	HP	∅ PISTON
CHT	1555	73	77.00

ILLINOIS

FORD

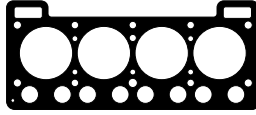
**JD-308-15**

TC-465-15 - 78MU6051A2
Junta Culata de Cilindros
Junta Cabeçote



1077200 - 0607332300
Base carburador
Base carburador



1003000 - 48470
Placa bomba de agua
Placa bomba de água



JSA-158 - 7702024218
73MU6020A
Salida Escape
Saída Escapamento



JVS-240-43 - BD1M6584A
7702220551/64293
Junta Tapa Válvula Superior
c/arandelas
Junta Tampa Válvula Superior
c/arruelas



JAE-390-E - BD9M6781A
Junta Escape
Junta Escapamento



1003500 - 48469
Tapa trasera tapa de cilindros
Tampa traseira cabeçote



1078800 - 7702020130
Tapón Tapa de Válvulas
Tampão cabeçote



JC-291-30 - A84SU6781A
BD9M6781A
Junta Cáster
Junta Carter



1002900 - 48437
Bomba de agua
Bomba de água



1129200
Bomba de nafta
Bomba de gasolina



RT-556Pol
Juego Ret. Guía de Vál.
Jogo Retentor da Haste
de Válvulas



1129100 - 7DBA2026A/73MU6020A
Distribución
Distribuição



1003100 - 65689
Bomba de aceite
Bomba de óleo



1129300 - 78MU6659A
Bomba de aceite
Bomba de óleo



2632200 - 6071557
Arandela tapón cáster
Arruela tampão carter
16 x 22 x 1mm
(Fibra)



1121500 - 78MU6055A
Suplemento camisa
Suplemento camisa



1077100 - 0602349600
7702023292/BDIM9417A
Bomba de nafta
Bomba de gasolina



1129000 - 65689
Bomba de aceite
Bomba de óleo



1109400 - 0607155700
Base distribuidor
Base distribuidor



1026700 - 4179113/4081258
Bomba de nafta
Bomba de gasolina



RT-8087Vit
Retén Bancada Lx-Hel
Ret. Traseiro do Virabrequim
82,00 x 105,00 x 12,00



RT-8006Pol
Retén Distribución A 156-R
Ret. Dianteiro do Virabrequim
35,00 x 50,00 x 10,00

Productos relacionados no incluidos en el juego. Los mismos pueden ser solicitados por separado.

Produtos relacionados não incluídos no jogo. Podem ser solicitados em separado.

Related products that were not included in the set but can be ordered separately.



JC-291-23
Junta Cáster
Junta Carter



JSA-158-11
Salida Escape
Saída Escapamento

DESCRIPCIÓN / Descrição / Description

FORD: Escort L/GL/GHIA - Corcel II - Scala
Del Rey - Verona 1989/... - Belina II - Pampa 83/...
VOLKSWAGEN: Saveiro - Gol - Voyage
Logus 1989/...

MOTOR / Engine	CM ³	HP	Ø PISTON
CHT	1555	73	77.00
AE	1555	73	77.00

Juego Completo de Reparación:

Jogo de Juntas do Motor / Full Set Gasket:

JR-339-15

R

Semi-Juego de Reparación:

Semi-Jogo de Juntas / Semi-Set Gasket:

SJ-339

R

Juego de Descarbonización:

Jogo de Juntas Superior / Head Set Gasket:

JD-339-15

R

JUNTA CULATA DE CILINDROS	TC-530-15	Ø 78.20mm	1.60mm	1.60mm
Junta de cabeçote	TC-530-18	Ø 78.20mm	2.50mm	2.50mm
Cylinder Head gasket				



JD-339-15

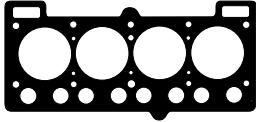

TC-530-15 - 84AU6051R
Junta Culata de Cilindros
Junta Cabeçote



1128500 - F203
Base carburador
Base carburador



1112000
Base bomba de agua
Base bomba de água



1129500 - 86AU8507A
Bomba de agua
Bomba de água



JAE-347 - 84AU9448C
Múltiple Admisión y Escape
Coletor Admissão e Escapamento



1128400 - BDSM6417
Entre múltiple escape
Entre multiplo escapamento



1129400 - 84AU6W021A
Bomba de agua
Bomba de água



2739200 - 5949822
O'ring 36 x 3mm
tapa de cilindro a calefactor
cabeçote ao aquecedor



JVS-240-43 - BD1M6584A/7702220551
Junta Tapa Válvula Superior
c/arrandelas
Junta Tampa Válvula Superior c/arruelas



JSA-195 - 85AU9451A
84AV9451A
Salida Escape
Saída Escapamento



1129600 - 86AU8255A
0291211392
Termostato
Termostato



RT-556Pol
Jgo. Ret. Guía de Vál.
Jogo Retentor da Haste
de Válvulas



JC-291-30 - A84SU6781A
Junta Cáster
Junta Carter



1128300 - 029121041/1
84AV8513
Bomba de agua
Bomba de água



1121500 - 78MU6055A
Suplemento camisa
Suplemento camisa



1109400 - 0607155700
Base distribuidor
Base distribuidor



1129100 - 7DBA2026A/73MU6020A
Distribución
Distribuição



1129000 - 0857726400
78MU6659A
Bomba de aceite
Bomba de óleo



1129300 - 78MU6659A
Bomba de aceite
Bomba de óleo



2611100 - EOFZ6734AA
Arandela tapón cáster
Arruela tampão carter
15 x 21x 2mm
(Aluminio)



1129200 - 75MU9417A
Bomba de nafta
Bomba de gasolina



RT-8087Vit
Retén Bancada
Retentor Traseiro do Virabrequim
Lx-Hel 82,00 x 105,00 x 12,00



RT-8006Pol
Retén Distribución
Retentor Dianteiro do Virabrequim
A 156-R 35,00 x 50,00 x 10,00

Productos relacionados no incluidos en el juego. Los mismos pueden ser solicitados por separado.

Produtos relacionados não incluídos no jogo. Podem ser solicitados em separado.

Related products that were not included in the set but can be ordered separately.



BU-038
Bulones para
Culata de Cilindros
Parafusos de Cabeçote



JV-158
Juego Caja Vel.
Jogo Caixa de
Câmbio



JB-203
Jgo. Carburador
Jogo Carburador



JC-291-23
Junta Cáster
Junta Carter



JSA-185
JSA-185-11
Salida Escape
Saída Escapamento



JSA-251
Salida Escape
Saída Escapamento

Juego Completo de Reparación:

Jogo de Juntas do Motor / Full Set Gasket:

Semi-Juego de Reparación:

Semi-Jogo de Juntas / Semi-Set Gasket:

Juego de Descarbonización:

Jogo de Juntas Superior / Head Set Gasket:

JUNTA CULATA DE CILINDROS Junta de cabeçote Cylinder Head gasket	TC-892 1M	∅ 76.00mm	1.25mm	de 0,61 a 0,72mm
	TC-892 2M	∅ 76.00mm	1.30mm	de 0,73 a 0,77mm
	TC-892 3M	∅ 76.00mm	1.35mm	de 0,78 a 0,82mm
	TC-892 4M	∅ 76.00mm	1.40mm	de 0,83 a 0,87mm
	TC-892 5M	∅ 76.00mm	1.45mm	de 0,88 a 0,98mm

DESCRIPCIÓN / Descrição / Description

DIESEL

FORD: CMax - Focus - Fusion TDCI 16V 2003/...

CITROEN: Xsara - Picasso - Jumpy -

Berlingo 1999/... - C2 - C3 - C4 - C5 TD 16V

PEUGEOT: 307 HDI 2004/... - 407 TD 2004/...

206 - 207 Compact - 1007 2003/... - Partner

VOLVO: S40 - V50 - C30 2005/... (DOHC) 16V

MOTOR / Engine	CM ³	HP	∅ PISTON
DV6TED4	1560	75/109	75.00
DV6TD4(9HZ)	1560	108	75.00
DV6TED4(9HZ)	1560	104	75.00
G8DA - DURATORQ	1560	90/109	75.00

ILLINOIS

FORD



JD-541-ST

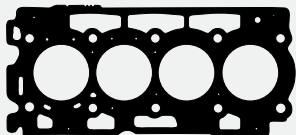

TC-892-20 1M TC-892-MG 1M - 0209CA
TC-892-20 2M TC-892-MG 2M - 0209CC
TC-892-20 3M TC-892-MG 3M - 0209CE
TC-892-20 4M TC-892-MG 4M - 0209CF
TC-892-20 5M TC-892-MG 5M - 0209CG

Junta Culata de Cilindros
Junta Cabeçote



JVS-330-43 - 0249C2
Junta Tapa Válvula Superior
Junta Tampa Válvula Superior



JC-358-34 - 12232358/1
Junta Cártel
Junta Carter

2626900
Arandela cárter
Arruela carter
17 x 21 x 1,25mm (Cobre)

2730300 - 7701049890
Chupador bomba de aceite
Pescador bomba óleo



2613500
Arandela asiento inyector
Arruela assento injetor
7 x 15 x 2mm (Cobre)



JAE-515-A - 0348R5
Juego Admisión
Jogo Admissão



JAE-511-E - 1152194/0349V8
Múltiple Escape
Coletor Escapamento



RT-9910Vit
Retén Árbol de Levas
Ret. do Eixo Comando de Válvulas
Lx-R 27,00 x 47,00 x 7,00



RT-896Vit
Juego Retenes Guía de Válvulas
Jogo Retedor da Haste de Válvulas



2714500
O'ring 18 x 3mm



2739800
O'ring 36 x 3mm



RT-8573Pol
Retén Distribución
Retedor Dianteiro do Virabrequim
A 156-R 40,00 x 55,00 x 8,00



RT-9196Vit
Retén Bancada
Retedor Traseiro do Virabrequim
Lx-R 85,00 x 105,00 x 8,00

Productos relacionados no incluidos en el juego. Los mismos pueden ser solicitados por separado.

Produtos relacionados não incluídos no jogo. Podem ser solicitados em separado.

Related products that were not included in the set but can be ordered separately.



BU-120
Bulones para
Culata de Cilindros
Parafusos Cabeçote



JAE-580-A
Conjunto Admisión
Conjunto Admissão



JT-141
Juego Turbo
Jogo Turbo

DESCRIPCIÓN / Descrição / Description

FORD: Focus 2004/... Fiesta Fusion 2003/...
CMax 2007/...
VOLVO: C30 S40 V50 2005/...

MOTOR / Engine	CM ³	HP	Ø PISTON
L4 Sigma (16V DOHC)	1596	100	79.00
FYJA/B/C (16V DOHC)	1596	100	79.00
HWDA/B (16V DOHC)	1596	100	79.00
SHDA/B/C B4164S3	1596	101	79.00

Juego Completo de Reparación:

Jogo de Juntas do Motor / Full Set Gasket:

JR-557

R

Semi-Juego de Reparación:

Semi-Jogo de Juntas / Semi-Set Gasket:

SJ-557

R

Juego de Descarbonización:

Jogo de Juntas Superior / Head Set Gasket:

JD-557

R

JUNTA CULATA DE CILINDROS

Junta de cabeçote
 Cylinder Head gasket

TC-936-15	Ø 80.00mm	1.50mm	±0.05
TC-936-MG	Ø 80.00mm	1.50mm	±0.05
TC-936-18	Ø 80.00mm	2.30mm	±0.05
	Ø		±0.05



JD-557

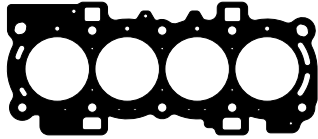

TC-936

7S7G6051CB/1471525/31216200
 Junta Culata de Cilindros
 Junta Cabeçote

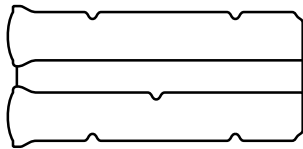

JVS-391-43 - 1S6G6K260AA/1141575
 Junta Tapa Válvula Superior
 Junta Tampa Válvula Superior



2771100

4M5G9P84BCA
 Junta mariposa
 Junta borboleta



2724800 - AM4S6G9186AA
 O'ring 7,52 x 3,53
 Inyector
 Injetor



JAE-601-A - 4M5G9441FA/EA/
 1142502/C20113111/30711597
 Juego Admisión
 Jogo Admissão



JAE-602-E - 844524J2WP/1326381/
 2S6G9448DA/C20113460/30681330
 Junta Escape
 Junta Escapamento

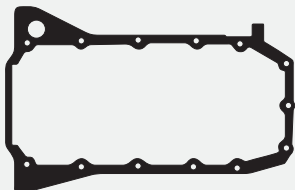

JC-384-15 - 1004459/96MM6710AD
 Junta Cárter
 Junta Carter



RT-9649Vit
 Retén Árbol de Levas
 Retentor do Eixo Comando de Válvulas
 Lx-R 38,00 x 52,00 x 6,00



RT-0811J
 Juego Retenes Guía de Válvulas
 Jogo Retentor da Haste de Válvulas



1009300 - 1007715/BE8Z8507A
 Bomba de agua
 Bomba de água



1009200 - 1004452/1107165/
 30711645
 Tapa distribución
 Tampa distribuição

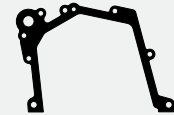

1141300 - BM5G6659BA/
 8S7G6659AB
 Tapa distribución
 Tampa distribuição



JSA-322 - 2S619451AC/
 1140134/1146867/1309484
 Salida Escape
 Saída Escapamento



2770900 - 1472862/
 7M5G8D020C
 Cuerpo termostato
 Corpo termostato



2737700 - 6465680/
 1021499/BE8Z8255Z
 Anillo termostato
 Anel termostato



2763900 - BE8Z8255A
 Salida de agua termostato
 Saída de água termostato



RT-9648Vit
 Retén Distribución
 Retentor Dianteiro do Virabrequim
 Lx-R 33,00 x 47,00 x 5,00

Productos relacionados no incluidos en el juego. Los mismos pueden ser solicitados por separado.

Produtos relacionados não incluídos no jogo. Podem ser solicitados em separado.

Related products that were not included in the set but can be ordered separately.



BU-012
 Bulones para
 Culata de Cilindros
 Parafusos de Cabeçote



JC-384-43
 Junta Cárter
 Junta Carter

Juego Completo de Reparación:

Jogo de Juntas do Motor / Full Set Gasket:

JR-696**R****Semi-Juego de Reparación:**

Semi-Jogo de Juntas / Semi-Set Gasket:

SJ-696**R****Juego de Descarbonización:**

Jogo de Juntas Superior / Head Set Gasket:

JD-696**R**

JUNTA CULATA DE CILINDROS	TC-936-15	∅ 80.00mm	∓ 1.50mm	↑ ↓
Junta de cabeçote	TC-936-MG	∅ 80.00mm	∓ 1.50mm	↑ ↓
Cylinder Head gasket	TC-936-18	∅ 80.00mm	∓ 2.30mm	↑ ↓

DESCRIPCIÓN / Descrição / Description

FORD: New Fiesta - EcoSport 2013/...
Focus - Mondeo 2007/...

MOTOR / Engine	CM ³	HP	∅ PISTON
Zetec-S Sigma (16HDEZ)	1596	100	79.00

ILLINOIS

FORD

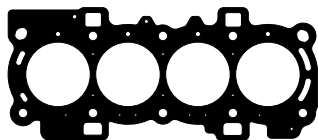
JD-696

TC-936
7S7G6051CB/1471525/31216200
Junta Culata de Cilindros
Junta Cabeçote

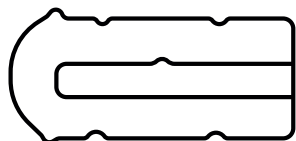

JVS-410-43
Junta Tapa Válvula Superior
Junta Tampa Válvula Superior



2771100
4M5G9P84BCA
Junta mariposa
Junta borboleta



2719700 - AM4S6G9186AA
O'ring 7,52 x 3,53
Inyector
Injetor



JAE-601-A - 4M5G9441FA/EA/
1142502/C20113111/30711597
Juego Admisión
Jogo Admissão



JAE-602-E - 844524J2WP/1326381/
2S6G9448DA/C20113460/30681330
Junta Escape
Junta Escapamento

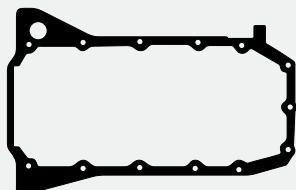

JC-384-15 - 1004459/96MM6710AD
Junta Cáster
Junta Carter



1009200 - 1004452/1107165/
30711645
Tapa distribución
Tampa distribuição



RT-0811J
Juego Retenes Guía de Válvulas
Jogo Retentor da Haste de Válvulas



1009300 - 1007715/BE8Z8507A
Bomba de agua
Bomba de água



2762700
Ventilación Cáster
Ventilação Cáster



RT-2957Pol
Retén Árbol de Levas
Retentor do Eixo Comando
de Válvulas
45,00 x 56,00 x 7,00



JSA-322 - 2S619451AC/
1140134/1146867/1309484
Salida Escape
Saída Escapamento



2770900 - 1472862/
7M5G8D020C
Cuerpo termostato
Corpo termostato



2737700 - 6465680/
1021499/BE8Z8255Z
Anillo termostato
Anel termostato



2763900 - BE8Z8255A
Salida de agua termostato
Saída de água termostato



RT-9648Vit
Retén Distribución
Retentor Dianteiro do Virabrequim
Lx-R 33,00 x 47,00 x 5,00

Productos relacionados no incluidos en el juego. Los mismos pueden ser solicitados por separado.

Produtos relacionados não incluídos no jogo. Podem ser solicitados em separado.

Related products that were not included in the set but can be ordered separately.

DESCRIPCIÓN / Descrição / Description

FORD: Sierra L/GL 1984/...

MOTOR / Engine	CM ³	HP	Ø PISTON
OHC	1597	75	81.30

Juego Completo de Reparación:

Jogo de Juntas do Motor / Full Set Gasket:

JR-296-15

R

Semi-Juego de Reparación:

Semi-Jogo de Juntas / Semi-Set Gasket:

Juego de Descarbonización:

Jogo de Juntas Superior / Head Set Gasket:

JD-296-15

R

JUNTA CULATA DE CILINDROS	TC-453-15	Ø 83.50mm	1.75mm	↑ ↓
Junta de cabeçote				↑ ↓
Cylinder Head gasket				↑ ↓

JD-296-15



TC-453-15 - 84HM6051AC
Junta Culata de Cilindros
Junta Cabeçote



JSA-194 - 81AB9451DA
Salida Escape
Saída Escapamento



JAE-345-A - 71HM9441AB
Junta Admisión
Junta Admissão



JAE-346-E
Junta Escape
Junta Escapamento



1130200 - 84BR8255A
Termostato
Termostato

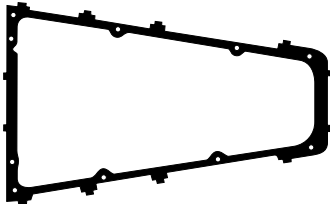

JVS-241-30 - 83HM6584AA
Junta Tapa Válvula Superior
Junta Tampa Válvula Superior



1130100 - 84HF9447AA
Base carburador
Base carburador



RT-546Pol
Juego Ret. Guía de Válvulas
Jogo Ret. da Haste de Válvulas

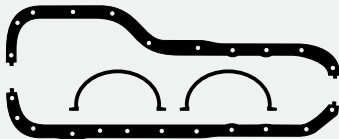

JC-290-30
Junta Cártér
Junta Carter



1129900 - 72HM6020AA
Distribución
Distribuição



1129700 - 70HM8507AA
Bomba de agua
Bomba de água



1030400 - 4194902
Soporte caño agua
Suporte cano água



1129800 - 71HM6659AB
Tubo bomba de aceite
Tubo bomba óleo



1130000 - 81SM9417CIA
Bomba de nafta
Bomba de gasolina



RT-8009Pol
Retén Bancada
Retentor Traseiro do Virabrequim
Mx-R 79,00 x 95,25 x 11,11



RT-8038Pol
Retén Distribución
Retentor Dianteiro do Virabrequim
Lx-Hel 42,00 x 56,00 x 7,00

Productos relacionados no incluidos en el juego. Los mismos pueden ser solicitados por separado.

Produtos relacionados não incluídos no jogo. Podem ser solicitados em separado.

Related products that were not included in the set but can be ordered separately.



BU-079
Bulones para Culata de Cilindros
Parafusos de Cabeçote



JB-200
Juego Carburador
Jogo Carburador

Juego Completo de Reparación:

Jogo de Juntas do Motor / Full Set Gasket:

JR-389

DESCRIPCIÓN / Descrição / Description

FORD: Courier - Ka 1997/... - Fiesta 1999/...
Fiesta Ikon 2000/... - Escort 2000/...
Ecosport 8V 2003/...**Semi-Juego de Reparación:**

Semi-Jogo de Juntas / Semi-Set Gasket:

SJ-389**Juego de Descarbonización:**

Jogo de Juntas Superior / Head Set Gasket:

JD-389

JUNTA CULATA DE CILINDROS	TC-728-15	Ø 83.50mm	1.50mm	↑ ↓
Junta de cabeçote	TC-728-MG	Ø 83.50mm	1.30mm	↑ ↓
Cylinder Head gasket	TC-728-18	Ø 83.50mm	2.30mm	↑ ↓

MOTOR / Engine	CM ³	HP	Ø PISTON
Zetec Rocam ZL	1598	95/98	82.00

ILLINOIS

FORD

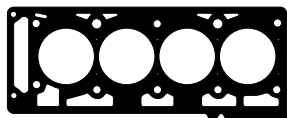
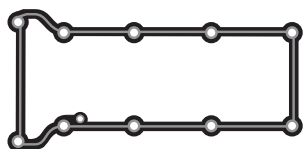
JD-389**TC-728** - XS6E6051BE
Junta Culata de Cilindros
Junta Cabeçote**2714200** - 958F9F670BB
Guarnición válvula IAC de gases
Guarnição válvula IAC de gases**2714100** - XS6E9P848AA
Guarnición válvula mariposa de gases
Guarnição válvula borboleta de gases**JAE-479-A** - XS6E9441AB
Juego Admisión
Jogo Admissão**JAE-477-E** - XS6E9448BB
Junta Escape
Junta Escapamento**2713900** - XS6E8255BB
Carcasa termostato
Carcaça termostato**JVS-303-43** - XS6E6584AB/6710A2B
Junta Tapa Válvula Superior
Junta Tampa Válvula Superior**2714000** - XS6E6K780AC
Guarnición salida de gases
Guarnição saída de gases**2714300**
O'ring 47,22 x 3,53mm
Termostato
Termostato**RT-2993PoI**
Juego Ret. Guía de Válvulas
Jogo Retenedor da Haste de Válv.**JC-338-43** - XS6E6710A2B
Junta Cártel (Goma-Metal)
Junta Carter (Borracha-Metal)**1140700** - XS6E6659A2B
Bomba de aceite
Bomba de óleo**1140800** - XS6E6L6221AD
Soporte filtro aceite
Suporte filtro óleo**RT-9826Vit**
Retén Distribución
Retenedor Diant. do Virabrequim
Lx-R 39,95 x 62,00 x 7,40

Productos relacionados no incluidos en el juego. Los mismos pueden ser solicitados por separado.

Produtos relacionados não incluídos no jogo. Podem ser solicitados em separado.

Related products that were not included in the set but can be ordered separately.

**BU-022**
Bulones para Culata de Cilindros
Parafusos de Cabeçote**BU-241**
Bulones p/Culata de Cil. con Fijación Tapa de Vál.
Parafusos de Cabeçote c/Fixação Tampa de Vál.**JV-151**
Juego Caja Velocidad
Jogo Caixa Câmbio**JSA-273-21**
2S659451BA/AA/5S659451AA
Salida Escape (Anillo Malla Ac.)
Saída Escapamento (Anel Malha Aço)**RT-9946Tef**
XS6E6K301BF/CA
Porta Retén Bancada
Flange Tras. do Virabrequim A 352-R 79,00

DESCRIPCIÓN / Descrição / Description **DIESEL**

FORD: Fiesta - Courier - Escort - Mondeo Orion D - Sierra TD - Mondeo TD 1991/... Escort TDI 1994/...

MOTOR / Engine	CM ³	HP	Ø PISTON
D18	1753	60/75	82.50
D18 T/TI	1753	75/90	82.50

Juego Completo de Reparación:

Jogo de Juntas do Motor / Full Set Gasket:

Semi-Juego de Reparación:

Semi-Jogo de Juntas / Semi-Set Gasket:

SJ-265

R

Juego de Descarbonización:

Jogo de Juntas Superior / Head Set Gasket:

JD-166-ST

R

JUNTA CULATA DE CILINDROS	TC-637-20 1M	Ø 84.00mm	1.20mm	± ... a 0,49mm
Junta de cabeçote	TC-637-20 2M	Ø 84.00mm	1.36mm	± de 0,50 a 0,68mm
Cylinder Head gasket	TC-637-20 3M	Ø 84.00mm	1.42mm	± de 0,69 a 0,74mm
	TC-637-20 4M	Ø 84.00mm	1.52mm	± de 0,75 a 0,84mm



TC-637-20 1M
TC-637-20 2M
TC-637-20 3M
TC-637-20 4M
Junta Culata de Cilindros
Junta Cabeçote

JD-166-ST



JAE-394-E - 1092074
Junta Escape
Junta Escapamento



JSA-204 - 92BB9451AA
1628164/6175938
Salida Escape
Saída Escapamento



1168300 - 89FF8255AA
6465080/1032504
Termostato
Termostato



JAE-354-A - 6180424
Junta Admisión
Junta Admissão



JAE-395-A - 6740296
Junta Admisión
Junta Admissão



JAE-510-A
Juego Admisión
Jogo Admissão



2737700 - 6465680
1021499
Anillo termostato
Anel termostato

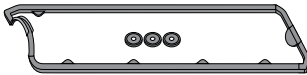

JVS-267-43 - 6765358
Junta Tapa Válvula Superior
c/arruelas
Junta Tampa Válvula Superior c/arruelas



1168000 - 6175933
Válvula reguladora de gases
Válvula reguladora de gases



JSA-287 - 6740297
Salida Escape Turbo
Saída Escapamento Turbo



RT-9204Pol
Retén Árbol de Levas
Retentor do Eixo
Comando de Válvulas
Lx-R 28,00 x 38,00 x 7,00

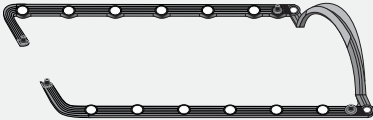

JC-311-43 - 1075963
Junta Cártel
Junta Carter



1167900 - 6169448
Distribución
Distribuição



1168100 - 6175096
Bomba de agua
Bomba de água



RT-546Pol
Juego Ret. Guía de Válvulas
Jogo Retentor da
Haste de Válvulas



2738200
O'ring 91 x 1,80mm



2707100
O'ring 40 x 3mm



1168500 - 96FF8507BA
6148285
Cuerpo bomba de agua
Corpo bomba de água



2714300
O'ring 47,20 x 3,53mm



2611100
Arandela 15 x 21 x 2mm
Arruela (Aluminio)



1168400 - 91FF6344AA/1630835
Brida trasera
Flange traseira



2737800
O'ring 20,50 x 2,50mm



2738100
O'ring 52,20 x 2,62mm



1167800 - 91FF6344AA
Mando bomba de agua
Comando bomba de água



2713800 - 6561244
Guarnición silicona bomba de aceite
Guarnição silicone bomba óleo



2713700 - 6175909
Guarnición silicona fij. placa de dist.
Guarnição silicone fixação
placa de distribuição



RT-8009Pol
Retén Bancada
Retentor Traseiro do Virabrequim
Mx-R 79,00 x 95,25 x 11,11



RT-9278Pol
Retén Distribución
Ret. Dianteiro do Virabrequim
Mx-R 66,67 x 89,30 x 10,00

Productos relacionados no incluidos en el juego. Los mismos pueden ser solicitados por separado

Produtos relacionados não incluídos no jogo. Podem ser solicitados em separado / Related products that were not included in the set but can be ordered separately.



BU-010
Bulones p/Cul. Cil.
Parafusos Cabeçote



RT-9947Tef
Porta Retén Bancada
Porta Retentor Mancal



RT-9616Vit
Porta Retén Auxiliar
Porta Retentor Auxiliar



JC-311-46 - 1075963
Junta Cártel
(Silicona/e)



1015000
Acople Caño Escape
Acoplamento cano escapamento



1014400
Acople Caño Escape
Acoplamento cano escapamento



JAE-394-09
JAE-394-11
Junta Escape/Escapamento

Juego Completo de Reparación:

Jogo de Juntas do Motor / Full Set Gasket:

Semi-Juego de Reparación:

Semi-Jogo de Juntas / Semi-Set Gasket:

Juego de Descarbonización:

Jogo de Juntas Superior / Head Set Gasket:

JUNTA CULATA DE CILINDROS	TC-263 1M	∅ 84.00mm	± 1.20mm	± 0.08	de 0,55 a 0,65mm
Junta de cabeçote	TC-263 2M	∅ 84.00mm	± 1.30mm	± 0.08	de 0,66 a 0,75mm
Cylinder Head gasket	TC-263 3M	∅ 84.00mm	± 1.40mm	± 0.08	de 0,76 a 0,85mm
	TC-263 4M	∅ 84.00mm	± 1.50mm	± 0.08	de 0,86 a ...

DESCRIPCIÓN / Descrição / Description

DIESEL

FORD: Fiesta TDDI 2000/...
Focus TDDI/TDCI/DI - Transit TDI/TDCI 2002/...

MOTOR / Engine	CM ³	HP	∅ PISTON
BHPA/BHPB/BHDA/BHDB	1753	75/90	82.50
LYNX (C9DC)	1753	75/90	82.50
DURATORQ	1753	115	82.50
ENDURA	1753	75	82.50

ILLINOIS

FORD



JD-379-ST

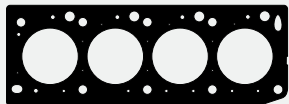

TC-263-20 1M TC-263-MG 1M
TC-263-20 2M TC-263-MG 2M
TC-263-20 3M TC-263-MG 3M
TC-263-20 4M TC-263-MG 4M
Junta Culata de Cilindros
Junta Cabeçote



JAE-395-A - 6740296
Junta Admisión
Junta Admissão



1156900 - 1113210
Intercooler
Intercooler



1168300 - 89FF8255AA
6465080/1032504
Termostato
Termostato



JAE-354-A - 6180424
Junta Admisión
Junta Admissão



1156700 - 1078500
Bomba de agua
Bomba de água



2737700 - 6465680/1021499
Anillo termostato
Anel termostato

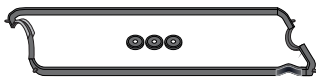

JVS-285-43 - 1078524
Junta Tapa Válvula Superior
c/arandelas
Junta Tampa Válvula Superior c/arruelas



JAE-394-E - 1092074
Junta Escape
Junta Escapamento



1156800 - 1094599
Bomba inyectora
Bomba injetora



RT-546Pol
Juego Retenes Guía de Vál.
Jogo Retentor da Haste
de Válvulas

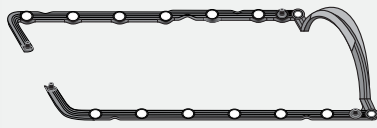

JC-345-43 - 1078498
Junta Cártel
Junta Carter

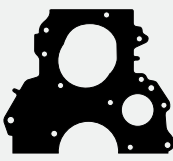

1156600 - 1078522
Frente motor
Frente motor



JSA-287 - 6740297
Salida Escape Turbo
Saída Escapamento
Turbo



RT-9204Pol
Retén Árbol de Levas
Ret. do Eixo Comando de Válvulas
Lx-R 28,00 x 38,00 x 7,00



1156400
Cártel inferior
Carter inferior

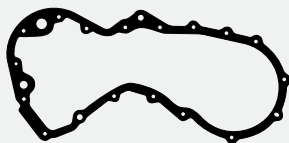

1156500 - 1113202
Frente bomba de aceite
Frente bomba óleo



RT-9193Vit
Retén Distribución
Ret. Dianteiro do Virabrequim
Lx-R 30,00 x 50,00 x 8,00

Productos relacionados no incluidos en el juego. Los mismos pueden ser solicitados por separado.

Produtos relacionados não incluídos no jogo. Podem ser solicitados em separado.

Related products that were not included in the set but can be ordered separately.



RT-9947Tef
Porta Retén Bancada
Flange Traseiro do Virabrequim
A 353-R 79,38



JAE-394-09
JAE-394-11- 1092074
Junta Escape
Escapamento

DESCRIPCIÓN / Descrição / Description

FORD: Escort - Fiesta/XR2 - Orion - Escort XR3I 1992/...

MOTOR / Engine	CM ³	HP	Ø PISTON
Zetec 16V	1796	105/115	80.60

Juego Completo de Reparación:

Jogo de Juntas do Motor / Full Set Gasket:

JR-390-15

R

Semi-Juego de Reparación:

Semi-Jogo de Juntas / Semi-Set Gasket:

SJ-390

R

Juego de Descarbonización:

Jogo de Juntas Superior / Head Set Gasket:

JD-390-15

R

JUNTA CULATA DE CILINDROS	TC-630-15	Ø 82.00mm	1.60mm	
Junta de cabeçote	TC-630-11	Ø 82.00mm	1.60mm	
Cylinder Head gasket	TC-630-18	Ø 82.00mm	2.50mm	



JD-390-15

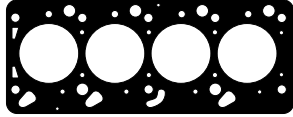

TC-630-15 - 6847748/928M/6051/BH
Junta Culata de Cilindros
Junta Cabeçote



JAE-446-A - 1048093/988M9461MA
Juego toberas admisión
Jogo coletor admissão



JAE-414-A - 1663383/928F9441D
Junta Admisión
Junta Admissão



JAE-408-09 - 7181761/938M9448A
Junta Escape
Junta Escapamento

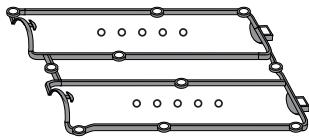

JVS-280-43 - 1663394/928M6584C1B
Junta Tapa Válvula Superior c/arandelas
Junta Tampa Válvula Superior c/arruelas

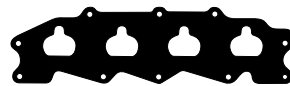

JAE-445-A - 6669767/928M9441GB
Junta Admisión
Junta Admissão



RT-2985A
Juego Retenes Guía de Válvulas
Jogo Retentor da Haste de Válvulas



RT-9283Pol
Retén Árbol de Levas
Ret. do Eixo Comando de Válvulas
Lx-R 42,00 x 53,00 x 7,00



JC-315-43 - 7008824/938M6710AC
Junta Cártel
Junta Carter



1197500 - 1663861/928M6344AA
Bancada trasera
Mancal traseira



1197400 - 7378788/968M6659AB
Frente bomba de aceite
Frente bomba de óleo



1197600 - 6691888
Bomba de agua
Bomba de água



1197800 - 7090340/9S8F9P848AD
Mariposa de gases
Borboleta de gases



1197700
Caja termostato
Caixa termostato



1197900 - 1663908/928M6625AA
Chupador aceite
Pescador óleo



2611100
Arandela 15 x 21 x 2mm
Arruela (Aluminio)



2714200 - 958F9F670BB
Guarnición/Guanirção válvula de gases
válvula IAC



RT-9608Vit
Retén Bancada Lx-Hel
Retentor Traseiro do Virabrequim
88,00 x 108,00 x 10,00



RT-8130Pol
Retén Distribución
Retentor Dianteiro do Virabrequim
Lx-R 35,00 x 50,00 x 8,00

Productos relacionados no incluidos en el juego. Los mismos pueden ser solicitados por separado
Produtos relacionados não incluídos no jogo. Podem ser solicitados em separado / Related products that were not included in the set but can be ordered separately.



BU-011
Bulones para
Culata de Cilindros
Parafusos de Cabeçote



JSA-265-22
Salida Escape
Saída Escapamento
(Fundición/Ferro)



JSA-265-21
Salida Escape
Saída Escapamento
(Anillo Malla Acero/Anel Malha Aço)



JC-315-46
Junta Cártel
Junta Carter
(Silicona/e)



JVS-280-46
Junta Tapa Válvula Superior c/arandelas
Junta Tampa Válvula Superior c/arruelas
(Silicona/e)

Juego Completo de Reparación:

Jogo de Juntas do Motor / Full Set Gasket:

JR-392-15**Semi-Juego de Reparación:**

Semi-Jogo de Juntas / Semi-Set Gasket:

SJ-392**Juego de Descarbonización:**

Jogo de Juntas Superior / Head Set Gasket:

JD-392-15

JUNTA CULATA DE CILINDROS	TC-630-15	∅ 82.00mm	∓ 1.60mm	∓
Junta de cabeçote	TC-630-11	∅ 82.00mm	∓ 1.60mm	∓
Cylinder Head gasket	TC-630-18	∅ 82.00mm	∓ 2.50mm	∓

DESCRIPCIÓN / Descrição / Description

FORD: Mondeo 1993/...

MOTOR / Engine

CM³

HP

∅ PISTON

Zetec 16V (DOHC)

1796

115

80.60

ILLINOIS

FORD

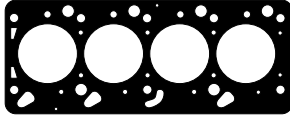
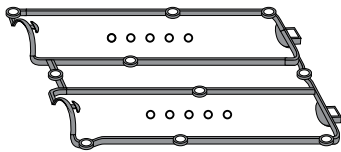
JD-392-15**TC-630-15** - 6847748/928M6051BH
Junta Culata de Cilindros
Junta Cabeçote**JAE-451-E** - 7181761
Junta Escape
Junta Escapamento**RT-2985A**
Juego Retenes Guía de Válvulas
Jogo Retentor da Haste de Válvulas**JVS-280-43** - 1663394/928M6584C1B
Junta Tapa Válvula Superior c/arrandelas
Junta Tampa Válvula Superior c/arruelas**JAE-450-A** - 6669767
Junta Admisión
Junta Admissão**RT-9283Pol**
Retén Árbol de Levas
Retentor do Eixo Comando de Válvulas
Lx-R 42,00 x 53,00 x 7,00**JC-315-43** - 7008824 - 938M6710AC
Junta Cártter
Junta Carter**1197500** - 1663861/928M6344AA
Bancada trasera
Traseira do Virabrequim**1197400** - 7378788/968M6659AB
Frente bomba de aceite
Frente bomba de óleo**1197600** - 6691888
Bomba de agua
Bomba de água**1197800** - 7090340/9S8F9P848AD
Mariposa de gases
Borboleta de gases**1197700**
Caja termostato
Caixa termostato**1197900** - 1663908/928M6625AA
Chupador aceite
Pescador óleo**261100**
Arandela 15 x 21 x 2mm
Arruela (Aluminio)**RT-9608Vit**
Retén Bancada Lx-Hel
Retentor Traseiro do Virabrequim
88,00 x 108,00 x 10,00**RT-8130Pol**
Retén Distribución
Retentor Dianteiro do Virabrequim
Lx-R 35,00 x 50,00 x 8,00

Productos relacionados no incluidos en el juego. Los mismos pueden ser solicitados por separado

Produtos relacionados não incluídos no jogo. Podem ser solicitados em separado / Related products that were not included in the set but can be ordered separately.

**BU-011**
Bulones p/ Culata de Cil.
Parafusos de Cabeçote**JSA-265-22**
Salida Escape
Saída Escapamento
(Fundición/Ferro)**JSA-265-21**
Salida Escape
Saída Escapamento
(Anillo Malla Acero/Anel Malha Aço)**JC-315-46**
Junta Cártter
(Silicona/e)**JVS-280-46**
Junta Tapa Válvula Superior c/arrandelas
Junta Tampa Válvula Superior c/arruelas
(Silicona/e)

Juego Completo de Reparación:

Jogo de Juntas do Motor / Full Set Gasket:

JR-360-15

DESCRIPCIÓN / Descrição / Description

FORD: Galaxy - Versailles - Verona - Escort 92/96
VOLKSWAGEN: Carat - Quantum - Pointer - Gol Golf - Santana 1989/...**Semi-Juego de Reparación:**

Semi-Jogo de Juntas / Semi-Set Gasket:

SJ-266**Juego de Descarbonización:**

Jogo de Juntas Superior / Head Set Gasket:

JD-171-15

JUNTA CULATA DE CILINDROS	TC-600-15	Ø 83.50mm	1.60mm	±0.05
	TC-600-18	Ø 83.50mm	2.50mm	±0.05
Junta de cabeçote				±0.05
Cylinder Head gasket				±0.05

MOTOR / Engine	CM ³	HP	Ø PISTON
Audi 827 AP	1984	107/115	82.50

ILLINOIS

FORD

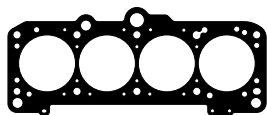
JD-171-15**TC-600-15** - 0531033834
Junta Culata de Cilindros
Junta Cabeçote**1177300** - 129799/94649659
Base carburador Brosol
Base carburador Brosol**2736400**
O'ring 35,3 x 3mm
Conexión TC a calefactor
Conexão cabeçote ao aquecedor**2736600**
Conducto admisión
Conduto admissão**JAE-339-A** - 026129717
Junta Admisión
Junta Admissão**JAE-337-E** - 056129589A
028129589B
Juego Escape
Jogo Escapamento**1114000** - 056121139B
Entrada agua
Entrada água**2736000** - 059121119
O'ring termostato
50 x 3,9mm**JVS-231-KIT** - 056103483C
Junta Tapa Válvula Superior
Junta Tampa Válvula Superior**1114100** - 056121149
Conector
Conector**RT-8422Pol**
Retén Distribución y Árbol de Levas
Retenedor Dist. y Árvore de Comando
Lx-Bidi 32,00 x 47,00 x 10,00**RT-562Pol**
Juego Retenes Guía de Válvulas
Jogo Retenedor haste de Válvulas**JC-278-30** - 056103609B
0491036091
Junta Cártér
Junta Carter**1113400** - 049121041B
056121041A
Bomba de agua
Bomba de água**1113600** - 056103161
Bancada delantera
Dianteira do Virabrequim**1113500** - 056103181B
Bancada trasera
Traseira do Virabrequim**1113800** - 056115441
Base filtro aceite
Base filtro óleo**JSA-185** - 843253115B
Salida Escape
Saída Escapamento**1113200** - 026905261A
Base distribuidor
Base distribuidor**2737200** - 90353501/056115037
O'ring 56,4 x 1,78mm
eje intermedio/eixo intermediário**1197100**
Bomba de aceite
Bomba de óleo**1144800** - 059127311A
Bomba de combustible
Bomba combustível**RT-6863Vit**
Retén Bancada
Retenedor Traseiro do Virabrequim
Lx-R 85,00 x 105,00 x 12,00**RT-6864Pol**
Retén Distribución y Árbol de Levas
Ret. Diam. do Virab. e Eixo Com. de Válv.
Lx-Bidi 32,00 x 47,00 x 10,00

Productos relacionados no incluidos en el juego. Los mismos pueden ser solicitados por separado

Produtos relacionados não incluídos no jogo. Podem ser solicitados em separado / Related products that were not included in the set but can be ordered separately.

**BU-042**
Bulones para
Culata de Cilindros
Parafusos de Cabeçote**JAE-337-09** - 056129589A
Juego Escape
Jogo Escapamento**JB-237**
Juego Carburador
Jogo Carburador**JB-217**
Juego Carburador
Jogo Carburador**JSA-218-21**
JSA-218-22
Salida Escape
Saída Escapamento**JC-278-15**
JC-278-23
JC-278-43
Junta Cártér
Junta Carter**2754900**
Tubo Sellador Válvula Venteo
Tubo vedação**JVS-231-23** - 056103483C
Junta Tapa Válvula Superior
Junta Tampa Válvula Superior**JSA-185-11**
Salida Escape
Saída Escapamento

DESCRIPCIÓN / Descrição / Description

FORD: Escort - Fiesta - Orion - Mondeo

MOTOR / Engine CM³ HP Ø PISTON

Zetec 16V 1989 136 84.80

Juego Completo de Reparación:

Jogo de Juntas do Motor / Full Set Gasket:

JR-391-15

R

Semi-Juego de Reparación:

Semi-Jogo de Juntas / Semi-Set Gasket:

SJ-390

R

Juego de Descarbonización:

Jogo de Juntas Superior / Head Set Gasket:

JD-391-15

R

JUNTA CULATA DE CILINDROS	TC-629-15	Ø 87.00mm	1.60mm	
Junta de cabeçote	TC-629-11	Ø 87.00mm	1.60mm	
Cylinder Head gasket	TC-629-18	Ø 87.00mm	2.30mm	



JD-391-15

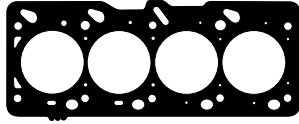

TC-629-15 - 7114447/938M6051CE
Junta Culata de Cilindros
Junta Cabeçote



JAE-446-A - 1048093/988M9461MA
Juego toberas admisión
Jogo coletor admissão



JAE-414-A - 1663383/928F9441D
Junta Admisión
Junta Admissão



JAE-408-09 - 7181761/938M9448A
Junta Escape
Junta Escapamento

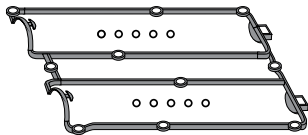

JVS-280-43 - 1663394/928M6584C1B
Junta Tapa Válvula Superior c/arruelas
Junta Tampa Válvula Superior c/arruelas



JAE-445-A - 6669767/928M9441GB
Junta Admisión
Junta Admissão



RT-2985A
Juego Retenes Guía de Válvulas
Jogo Retentor da Haste de Válvulas



RT-9283Pol
Retén Árbol de Levas
Ret. do Eixo Comando de Válvulas
Lx-R 42,00 x 53,00 x 7,00



JC-315-43 - 7008824/938M6710AC
Junta Cártel
Junta Carter



1197500 - 1663861/928M6344AA
Bancada trasera
Mancal traseira



1197400 - 7378788/968M6659AB
Frente bomba de aceite
Frente bomba de óleo



1197600 - 6691888
Bomba de agua
Bomba de água



1197800 - 7090340/9S8F9P848AD
Mariposa de gases
Borboleta de gases



1197700
Caja termostato
Caixa termostato



1197900 - 1663908/928M6625AA
Chupador aceite
Pescador óleo



2611100
Arandela 15 x 21 x 2mm
Arruela (Aluminio)



2714200 - 958F9F670BB
Guarnición/Guarnição válvula de gases
válvula IAC



RT-9608Vit
Retén Bancada Lx-Hel
Retentor Traseiro do Virabrequim
88,00 x 108,00 x 10,00



RT-8130Pol
Retén Distribución
Retentor Dianteiro do Virabrequim
Lx-R 35,00 x 50,00 x 8,00

Productos relacionados no incluidos en el juego. Los mismos pueden ser solicitados por separado
Produtos relacionados não incluídos no jogo. Podem ser solicitados em separado / Related products that were not included in the set but can be ordered separately.



BU-011
Bulones p/Culata de Cil.
Parafusos de Cabeçote



JSA-265-22
Salida Escape
Saída Escapamento
(Fundición/Ferro)



JSA-265-21
Salida Escape
Saída Escapamento
(Anillo Malla Acero/Anel Malha Aço)



JC-315-46
Junta Cártel
Junta Carter
(Silicona/e)



JVS-280-46
Junta Tapa/Tampa Válvula Superior
(Silicona/e) c/arruelas/arruelas

Juego Completo de Reparación:

Jogo de Juntas do Motor / Full Set Gasket:

JR-393-15

DESCRIPCIÓN / Descrição / Description

FORD: Mondeo 1993/01**Semi-Juego de Reparación:**

Semi-Jogo de Juntas / Semi-Set Gasket:

SJ-393**Juego de Descarbonización:**

Jogo de Juntas Superior / Head Set Gasket:

JD-393-15

JUNTA CULATA DE CILINDROS	TC-629-15	Ø 87.00mm	1.60mm	1.60mm
Junta de cabeçote	TC-629-11	Ø 87.00mm	1.60mm	1.60mm
Cylinder Head gasket	TC-629-18	Ø 87.00mm	2.30mm	2.30mm

MOTOR / Engine	CM ³	HP	Ø PISTON
Zetec 16V (DOHC)	1989	136	84.80

ILLINOIS

FORD

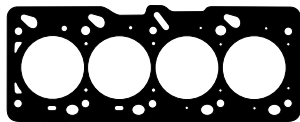
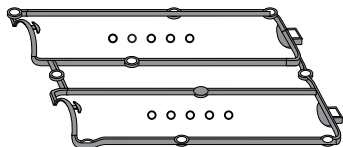
**JD-393-15****TC-629-15** - 7114447/938M6051CE
Junta Culata de Cilindros
Junta Cabeçote**JAE-446-A** - 1048093/988M9461MA
Juego toberas admisión
Jogo coletor admissão**JAE-414-A** - 1663383/938M9441D
Junta Admisión
Junta Admissão**JAE-451-E** - 7181761
Junta Escape
Junta Escapamento**JVS-280-43** - 1663394/928M6584C1B
Junta Tapa Válvula Superior c/arandelas
Junta Tampa Válvula Superior c/arruelas**JAE-450-A** - 6669767
Junta Admisión
Junta Admissão**RT-2985A**
Juego Retenes Guía de Válvulas
Jogo Retentor da Haste de Válvulas**RT-9283Pol**
Retén Árbol de Levas
Retentor do Eixo Comando de Válvulas
Lx-R 42,00 x 53,00 x 7,00**JC-315-43** - 7008824/938M6710AC
Junta Cáster
Junta Carter**1197500** - 1663861/928M6344AA
Bancada trasera
Mancal traseira**1197400** - 7378788/968M6659AB
Frente bomba de aceite
Frente bomba de óleo**1197600** - 6691888
Bomba de agua
Bomba de água**1197800** - 7090340/9S8F9P848AD
Mariposa de gases
Borboleta de gases**1197700**
Caja termostato
Caixa termostato**1197900** - 1663908/928M6625AA
Chupador aceite
Pescador óleo**2611100**
Arandela 15 x 21 x 2mm
Arruela (Aluminio)**RT-9608Vit**
Retén Bancada Lx-Hel
Retentor Traseiro do Virabrequim
88,00 x 108,00 x 10,00**RT-8130Pol**
Retén Distribución
Retentor Dianteiro do Virabrequim
Lx-R 35,00 x 50,00 x 8,00

Productos relacionados no incluidos en el juego. Los mismos pueden ser solicitados por separado

Produtos relacionados não incluídos no jogo. Podem ser solicitados em separado / Related products that were not included in the set but can be ordered separately.

**BU-011**
Bulones p/Culata de Cilindro
Parafusos de Cabeçote**JSA-265-22**
Salida Escape
Saída Escapamento
(Fundición/Ferro)**JSA-265-21**
Salida Escape
Saída Escapamento
(Anillo Malla Acero/Anel Malha Aço)**JC-315-46**
Junta Cáster
(Silicona/e)**JVS-280-46**
Junta Tapa de Válvula Superior c/arandelas
Junta Tampa de Válvula Superior c/arruelas
(Silicona/Silicone)

DESCRIPCIÓN / Descrição / Description

FORD: Focus 1992/02 - Maverick 2000/...
Cougar 1999/...

MOTOR / Engine	CM ³	HP	Ø PISTON
YF	1989	124	84.80
EDBA/EDBB	1989	124	84.80
EDBC/EDBD	1989	131	84.80

Juego Completo de Reparación:

Jogo de Juntas do Motor / Full Set Gasket:

JR-566-15

R

Semi-Juego de Reparación:

Semi-Jogo de Juntas / Semi-Set Gasket:

SJ-566

R

Juego de Descarbonización:

Jogo de Juntas Superior / Head Set Gasket:

JD-566-15

R

JUNTA CULATA DE CILINDROS	TC-818-15	Ø 87.00mm	1.50mm	1.50mm	1.50mm
Junta de cabeçote					
Cylinder Head gasket					



JD-566-15

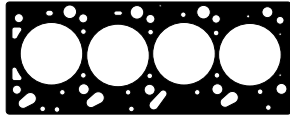

TC-818-15 - 1105772
Junta Culata de Cilindros
Junta Cabeçote



1197800 - 7090340/9S8F9P848AD
Cuerpo mariposa
Corpo borboleta

RT-2985A
Juego Retenes Guía de Válvulas
Jogo Retentor da Haste de Válvulas

RT-9283Pol
Retén Árbol de Levas
Retentor do Eixo Comando de Válvulas
Lx-R 42,00 x 53,00 x 7,00



JAE-574-A - 1090949
Juego Admisión
Jogo Admissão



JAE-575-E - 1053902
Junta Escape
Junta Escapamento

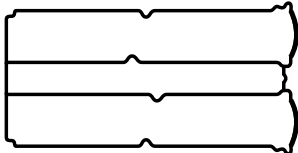

JVS-376-43 - 11261200
Junta Tapa Válvula Superior
Junta Tampa Válvula Superior



JAE-445-A - 6669767/928M9441GB
Junta Admisión
Junta Admissão



1401900 - 115070
Cierre bomba de agua
Fechamento bomba de água

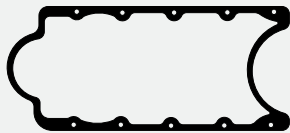

JC-407-43 - 1078307
Junta Carter
Junta Carter

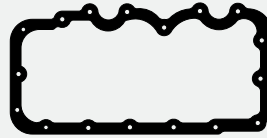

JC-408-25 -
Junta Carter Inferior
Junta Carter Inferior



1401700 - 1211001
Frente bomba de aceite
Frente bomba de óleo



1197600 - 6691888
Bomba de agua
Bomba de água



1401800 - 978Z6344AA
Bancada trasera
Traseiro do Virabrequim

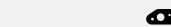

1197900 - 1663908/928M6625AA
Chupador aceite
Pescador óleo



2714200 - 958F9F670BB
Guarnición/Guarinição válvula de gases
válvula IAC



2760500 - 1092262
Termostato



2760400 - 6974940
Base termostato



2761000
O'ring 69,44 x 3,53mm
Bomba de agua/água



RT-9608Vit
Retén Bancada
Retentor Traseiro do Virabrequim
Lx-Hel 88,00 x 108,00 x 10,00



RT-8130Pol
Retén Distribución
Retentor Dianteiro do Virabrequim
Lx-R 35,00 x 50,00 x 8,00

Productos relacionados no incluidos en el juego. Los mismos pueden ser solicitados por separado.

Produtos relacionados não incluídos no jogo. Podem ser solicitados em separado.

Related products that were not included in the set but can be ordered separately.

Juego Completo de Reparación:

Jogo de Juntas do Motor / Full Set Gasket:

JR-274-15**R****Semi-Juego de Reparación:**

Semi-Jogo de Juntas / Semi-Set Gasket:

Juego de Descarbonización:

Jogo de Juntas Superior / Head Set Gasket:

JD-116-15**R**

JUNTA CULATA DE CILINDROS	TC-426-15	Ø 91.20mm	1.80mm	↑ ↓
Junta de cabeçote		Ø		↑ ↓
Cylinder Head gasket		Ø		↑ ↓

DESCRIPCIÓN / Descrição / Description

FORD: Taunus L 1974/81 - GXL - Ghia 1974/...

MOTOR / Engine	CM ³	HP	Ø PISTON
OHC	1990	63	89.32

ILLINOIS.

FORD

**JD-116-15**

TC-426-15 - 74BR6051H
Junta Culata de Cilindros
Junta Cabeçote



JAE-303-A - 74BR9439A
Junta Admisión
Junta Admissão



JAE-311-E - 74BR9430A/78BR9448A
Junta Escape
Junta Escapamento

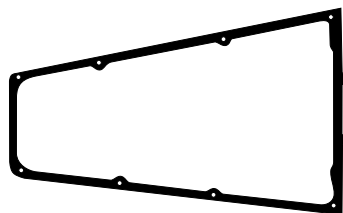

JVS-201-30 - 74BR6584B
Junta Tapa Válvula Superior
Junta Tampa Válvula Superior



1042900 - 74BR8255A
Termostato
Termostato



RT-506PoI
Juego Retenes Guía de Válvulas
Jogo Retentor da Haste de Válvulas



JC-244-30 - 74BR6710/11
Junta Carter
Junta Carter



1042700 - 74BR6020A
Tapa distribución
Tampa distribuição



1043000 - 74BR8507A
Bomba de agua
Bomba de água



1043100 - 74BR9417A
Bomba de combustible
Bomba de combustível



1042800 - 74BR6625A
Bomba de aceite
Bomba de óleo



RT-8010PoI
Retén Bancada
Retentor Traseiro do Virabrequim
Lx-Hel 92,00 x 108,00 x 9,80



RT-6684PoI
Retén Reforma Bancada
Retentor Reforma Traseiro do Virabrequim
Lx-Hel 92,00 x 106,50 x 5,40



RT-6680PoI
Retén Distribución
Ret. Dianteiro do Virabrequim
A 083-R 43,40 x 56,10 x 9,00

Productos relacionados no incluidos en el juego. Los mismos pueden ser solicitados por separado.

Produtos relacionados não incluídos no jogo. Podem ser solicitados em separado.

Related products that were not included in the set but can be ordered separately.



BU-080
Bulones p/Culata de Cil.
Parafusos de Cabeçote



JV-115
Juego Caja Vel.
Jgo. Caixa de Câmbio



JV-142
Juego Caja Vel. (5 Vel.)
Jogo Caixa de Câmbio



JB-144
Juego Carburador
Jogo Carburador

DESCRIPCIÓN / Descrição / Description

FORD: Mondeo 2001/... - Focus 2000/... - Ecosport 2003/...
MAZDA: 3 2003/... - 5 2005/...
 (Tapa de válvulas plástica)

MOTOR / Engine	CM ³	HP	Ø PISTON
CJBA/B	1999	143/145	87.50
AOBA/C	1999	145	87.50
LF/LH	1999	104	87.50
DURATEC HE 16V			

Juego Completo de Reparación:

Jogo de Juntas do Motor / Full Set Gasket:

JR-362

R

Semi-Juego de Reparación:

Semi-Jogo de Juntas / Semi-Set Gasket:

SJ-362

R

Juego de Descarbonización:

Jogo de Juntas Superior / Head Set Gasket:

JD-362

R

JUNTA CULATA DE CILINDROS	TC-807-15	Ø 89.00mm	1.20mm
Junta de cabeçote	TC-807-MG	Ø 89.00mm	1.20mm
Cylinder Head gasket	TC-807-18	Ø 89.00mm	2.30mm
	TC-807-11	Ø 89.00mm	0.50mm

JD-362

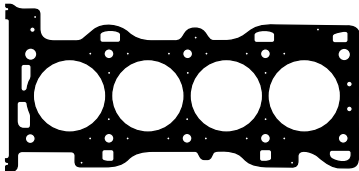

TC-807 - 1S7G6051AJ/1S7Z6051AA/
L30910271/LF0110271/LF0210271
Junta Culata de Cilindros
Junta Cabeçote



2757000 - 1S7Z9E9360A
Válvula mariposa aceleración
Válvula borboleta aceleração



JSA-307
1S719451AA/1133143
Salida Escape
Saída Escapamento



2757200 - 1S7Z8255BC
Válvula termostato
Válvula termostato



JAE-416-E - 1S7Z9448AA
Junta Escape
Junta Escapamento



JAE-417-A - 1S7Z9439AA
Juego Admisión
Jogo Admissão



2756900
Caja mariposa
Caixa borboleta



2756800 - 1S7Z9F670AA
Válvula reguladora paso a paso
Válvula reguladora passo a passo

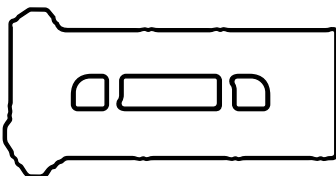

JVS-348-43 - 1220025/LF0210230
Junta Tapa Válvula Superior
Junta Tampa Válvula Superior



1003600 - 1S7Z6659AA
Base bomba de aceite
Base bomba de óleo



1004100 - 1119275
Conexión salida agua
Conexão saída água

RT-894Vit
Juego Retenes Guía de Válvulas
Jogo Retentor da Haste de Válvulas



2757300 - 1S7Z6B752AA
Separador bomba aceite
Separador bomba óleo



2713500 - 1119277
O'ring 64 x 3mm
Bomba agua
Bomba água



1004000 - 1S7Z6840AA
Base filtro aceite
Base filtro óleo



1187200 - 1355115
Válvula EGR



1187300
Arandela (Acero Inoxidable)
Arruela (Aço Inoxidável)
2,6 x 3,2 mm



2757400 - 1119253
Chupador bomba de aceite
Pescador bomba de óleo

RT-2986Pol
Retén Distribución
Ret. Dianteiro do Virabrequim
37,00 x 50,00 x 8,00

Productos relacionados no incluidos en el juego. Los mismos pueden ser solicitados por separado.

Produtos relacionados não incluídos no jogo. Podem ser solicitados em separado.

Related products that were not included in the set but can be ordered separately.



RT-3005
Porta Retén Bancada
Flange Traseiro do Virabrequim
88 x 169,6 x 14

Juego Completo de Reparación:

Jogo de Juntas do Motor / Full Set Gasket:

JR-363**R****Semi-Juego de Reparación:**

Semi-Jogo de Juntas / Semi-Set Gasket:

SJ-363**R****Juego de Descarbonización:**

Jogo de Juntas Superior / Head Set Gasket:

JD-363**R**

JUNTA CULATA DE CILINDROS	TC-807-15	Ø 89.00mm	± 1.20mm	± 0.05
	TC-807-MG	Ø 89.00mm	± 1.20mm	± 0.05
Junta de cabeçote	TC-807-18	Ø 89.00mm	± 2.30mm	± 0.05
Cylinder Head gasket	TC-807-11	Ø 89.00mm	± 0.50mm	± 0.05

DESCRIPCIÓN / Descrição / Description

FORD: Mondeo 2001/... - Focus 2000/... - Ecosport 2003/...
MAZDA: 3 2003/... - 5 2005/...
 (Tapa de válvulas de aluminio)

MOTOR / Engine	CM ³	HP	Ø PISTON
CJBA/B	1999	143/145	87.50
AOBA/C	1999	145	87.50
LF/LH	1999	104	87.50
DURATEC HE 16V			

ILLINOIS

FORD

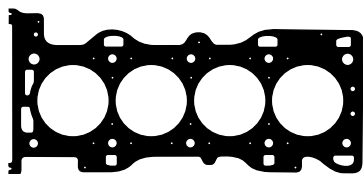
**JD-363**

TC-807 - 1S7G6051AJ/1S7Z6051AA/
L30910271/LF0110271/LF0210271
Junta Culata de Cilindros
Junta Cabeçote



2757000 - 1S7Z9E9360A
Válvula mariposa aceleración
Válvula borboleta aceleração



JSA-307
1S719451AA/1133143
Salida Escape
Saída Escapamento



2757200 - 1S7Z8255BC
Válvula termostato
Válvula termostato



JAE-416-E - 1S7Z9448AA
Junta Escape
Junta Escapamento



JAE-417-A - 1S7Z9439AA
Juego Admisión
Jogo Admissão



2756900
Caja mariposa
Caixa borboleta



2756800 - 1S7Z9F670AA
Válvula reguladora paso a paso
Válvula reguladora passo a passo

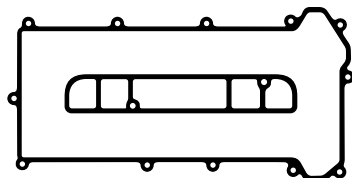

JVS-349-43 - 1S7G6584AE/LF0110230
Junta Tapa Válvula Superior
Junta Tampa Válvula Superior



1003600 - 1S7Z6659AA
Base bomba de aceite
Base bomba de óleo



1004100 - 1119275
Conexión salida agua
Conexão saída água



RT-894Vit
Juego Retenes Guía de Válvulas
Jogo Retentor da Haste de Válvulas



2757300 - 1S7Z6B752AA
Separador bomba aceite
Separador bomba óleo



2713500 - 1119277
O'ring bomba agua
bomba de água
64 x 3mm



1004000 - 1S7Z6840AA
Base filtro aceite
Base filtro óleo



1187200 - 1355115
Válvula EGR



1187300
Arandela (Acero Inoxidable)
Arruela (Aço Inoxidável)
2,6 x 3,2 mm



2757400 - 1119253
Chupador bomba de aceite
Pescador bomba de óleo



RT-2986Pol
Retén Distribución
Ret. Dianteiro do Virabrequim
37,00 x 50,00 x 8,00

Productos relacionados no incluidos en el juego. Los mismos pueden ser solicitados por separado.

Produtos relacionados não incluídos no jogo. Podem ser solicitados em separado.

Related products that were not included in the set but can be ordered separately.



RT-3005
Porta Retén Bancada
Flange Traseiro do Virabrequim
88 x 169,6 x 14

DESCRIPCIÓN / Descrição / Description

FORD: Mondeo IV 2010/... - S-Max 2010/...

MOTOR / Engine	CM ³	HP	Ø PISTON
TNBA	1999	203	87.50
TNWA/TNWB	1999	199/203	87.50
TPBA	1999	240	87.50
TPWA	1999	240	87.50

Juego Completo de Reparación:

Jogo de Juntas do Motor / Full Set Gasket:

JR-809-11



Semi-Juego de Reparación:

Semi-Jogo de Juntas / Semi-Set Gasket:

Juego de Descarbonización:

Jogo de Juntas Superior / Head Set Gasket:

JUNTA CULATA DE CILINDROS	TC-645-11	Ø 89.00mm	0.90mm	RECORRIDO
Junta de cabeçote				RECORRIDO
Cylinder Head gasket				RECORRIDO

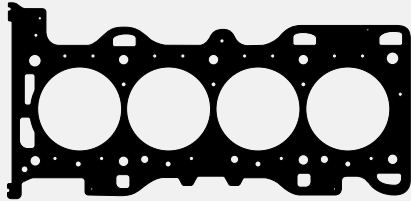

TC-645-11

5194031/1682135/5170592/5194031/BB5E6051BA/BB
Junta Culata de Cilindros
Junta Cabeçote



Junta Escape
Junta Escapamento



Junta

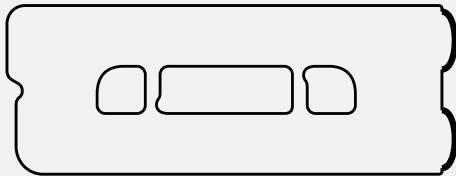

Junta Tapa Válvula Superior
Junta Tampa Válvula Superior



Junta Admisión
Junta Admissão



Junta



Juego Retenes Guía de Válvulas
Jogo Retentor da Haste de Válvulas



Retén Distribución
Retentor Dianteiro do Virabrequim



Productos relacionados no incluidos en el juego. Los mismos pueden ser solicitados por separado.

Produtos relacionados não incluídos no jogo. Podem ser solicitados em separado.

Related products that were not included in the set but can be ordered separately.

Juego Completo de Reparación:

Jogo de Juntas do Motor / Full Set Gasket:

JR-810-11**R**

DESCRIPCIÓN / Descrição / Description

FORD: Focus III 2013/...**Semi-Juego de Reparación:**

Semi-Jogo de Juntas / Semi-Set Gasket:

Juego de Descarbonización:

Jogo de Juntas Superior / Head Set Gasket:

JUNTA CULATA DE CILINDROS	TC-644-11	Ø 89.00mm	0.60mm	↑ ↓
Junta de cabeçote				↑ ↓
Cylinder Head gasket				↑ ↓

MOTOR / Engine	CM ³	HP	Ø PISTON
MGDA	1999	170	87.50
XQDA	1999	150	87.50

ILLINOIS.

FORD

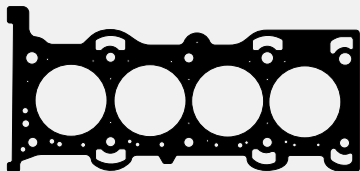

TC-644-11 - 5185441/CM5E6051DF
Junta Culata de Cilindros
Junta Cabeçote

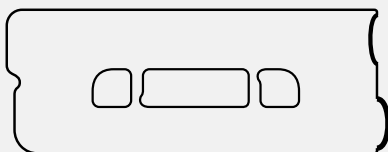
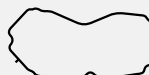

Junta

Base filtro aceite
Base filtro óleoJunta Escape
Junta EscapamentoJuego Admisión
Jogo AdmissãoConexión salida agua
Conexão saída águaJunta Tapa Válvula Superior
Junta Tampa Válvula SuperiorSeparador bomba aceite
Separador bomba óleo

Válvula EGR



Junta



Junta

Válvula termostato
Válvula termostatoJuego Retenes Guía de Válvulas
Jogo Retentor da Haste de VálvulasRetén Distribución
Retentor Dianteiro do VirabrequimRetén Árbol de Leva
Retentor do Eixo Comando de VálvulasPorta Retén Bancada
Flange Traseiro do Virabrequim

Productos relacionados no incluidos en el juego. Los mismos pueden ser solicitados por separado.

Produtos relacionados não incluídos no jogo. Podem ser solicitados em separado.

Related products that were not included in the set but can be ordered separately.

DESCRIPCIÓN / Descrição / Description

FORD: A - AA 1928/31

MOTOR / Engine	CM ³	HP	Ø PISTON
Autos (3 7/8 x 4 1/2)	2100	24	98.40
	3286	24	98.40

Juego Completo de Reparación:

Jogo de Juntas do Motor / Full Set Gasket:

JR-154-05

Semi-Juego de Reparación:

Semi-Jogo de Juntas / Semi-Set Gasket:

Juego de Descarbonización:

Jogo de Juntas Superior / Head Set Gasket:

JUNTA CULATA DE CILINDROS	TC-234-05	Ø 100.00mm	1.80mm	1103200
Junta de cabeçote				1103200
Cylinder Head gasket				1103200

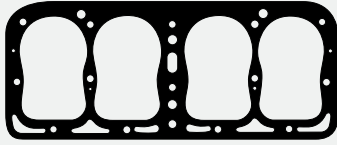

TC-234-05 - A6051A
Junta Culata de Cilindros
Junta Cabeçote



1121300 - A8255
Salida agua
Saída água



1121400 - R6619
Bomba de aceite
Bomba de óleo



JAE-197 - A18511
Múltiple Admisión y Escape
Coletor Admissão e Escapeamento



1103600 - A9447
Base carburador
Base carburador



1103200 - A8280
Entrada agua
Entrada água

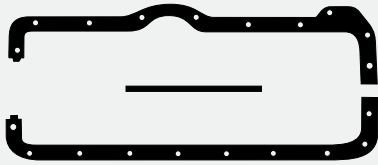

JC-159-30 - A6871
Junta Cáster
Junta Carter



1102700 - A6020
Tapa distribución
Tampa distribuição



1128700 - B6396
Cubierta embrague
Cobertura embreagem



1103100 - A6521
Tapa de válvula
Tampa de válvula



1121100 - A8507
Bomba de agua
Bomba de água

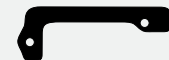

1128800 - B6018
Tapa distribución
Tampa distribuição

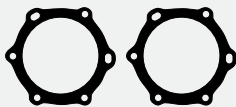

1104400 - A4515/B6393
Junta universal
Junta universal



1121200 - A9592
Carburador
Carburador



1104500 - B6700
Bancada
Mancal



1103500 - A6648
Caño aceite
Tubo óleo

Productos relacionados no incluidos en el juego. Los mismos pueden ser solicitados por separado.

Produtos relacionados não incluídos no jogo. Podem ser solicitados em separado.

Related products that were not included in the set but can be ordered separately.

Juego Completo de Reparación:

Jogo de Juntas do Motor / Full Set Gasket:

Semi-Juego de Reparación:

Semi-Jogo de Juntas / Semi-Set Gasket:

Juego de Descarbonización:

Jogo de Juntas Superior / Head Set Gasket:

SJ-560**JD-560-ST**

JUNTA CULATA DE CILINDROS	TC-695-MG 2M	∅ 87.00mm	1.15mm	∅
	TC-695-MG 3M	∅ 87.00mm	1.20mm	∅
Junta de cabeçote	TC-695-MG 4M	∅ 87.00mm	1.25mm	∅
Cylinder Head gasket				

DESCRIPCIÓN / Descrição / Description

DIESEL**FORD:** Ranger XL 4x2/4x4 TDCi Transit TDCi 2006/...**FIAT:** Ducato 2006/...**CITROEN:** Jumper HDI 2006/...**PEUGEOT:** Boxer HDI 2006/...

MOTOR / Engine	CM ³	HP	∅ PISTON
Puma TDCi eTGV	2198	123	86.00
4HU/4HV (P22DTE)	2198	101/120	86.00
(DOHC) 16V			

ILLINOIS

FORD

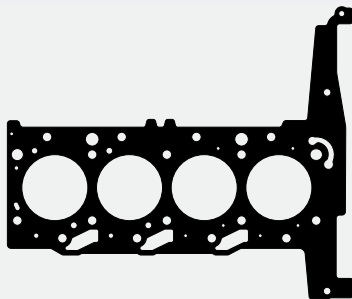
**TC-695-MG 2M** - 1776501/1717594/BK3Q6051B1C/B1B**TC-695-MG 3M** - 1776502/1717596/BK3Q6051C1C/C1B**TC-695-MG 4M** -

Junta Culata de Cilindros/Junta Cabeçote

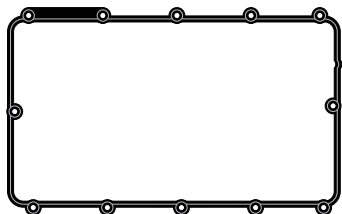
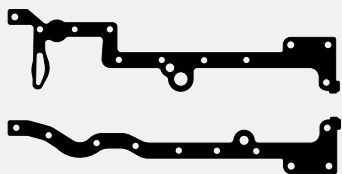
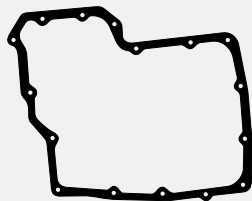
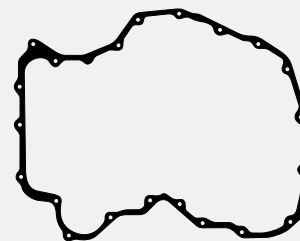
JD-560-ST**JVS-367-43** - 1760799/1848542/
BK2Q6K260AB/9677747480
Junta Tapa Válvula Superior
Junta Tampa Válvula Superior**JAE-609-A** - 1138392/9661743180/0348T1
Juego Admisión
Jogo Admissão**JAE-610-E** - 1120402/1137860
Junta Escape
Junta Escapamento**2703500** - 1738590
Anillo Admisión
Anel Admissão**2704800** - 1098228
Termostato**JC-402-15** - 1228836/112953
Junta Carter
Junta Carter**JC-403-25**
Junta Carter Intermedia
Junta Carter Intermediária**1185000** - 1102681
Frente Distribución
Frente Distribuição**1156800** - 1094599
Bomba inyectora
Bomba injetora**1198000** - 1322526/1107599/
4C1Q8K525AB/YC1Q8K525AC
Tubo refrigerante
Tubo refrigeração**1199400** - 1121210
Distribución a block
Distribuição ao bloco**1177500** - 1096559
Bomba de agua
Bomba de água**2701100** - 1721342
Filtro de aceite
Filtro de óleo**1194200** - 1105321
Chupador aceite
Pescador óleo**1196600** - 1146959
Bomba vacío
Bomba vácuo

Productos relacionados no incluidos en el juego. Los mismos pueden ser solicitados por separado.

Produtos relacionados não incluídos no jogo. Podem ser solicitados em separado.

Related products that were not included in the set but can be ordered separately.

DESCRIPCIÓN / Descrição / Description			
FORD: Ranger 2001/... - Ecosport 2003/... Mondeo 2002/...			
MOTOR / Engine	CM ³	HP	Ø PISTON
Duratec L3 IVC 16V	2261	141	87.50

Juego Completo de Reparación: Jogo de Juntas do Motor / Full Set Gasket:	JR-780	R		
Semi-Juego de Reparación: Semi-Jogo de Juntas / Semi-Set Gasket:	SJ-780	R		
Juego de Descarbonización: Jogo de Juntas Superior / Head Set Gasket:	JD-780	R		
JUNTA CULATA DE CILINDROS Junta de cabeçote Cylinder Head gasket	TC-808-15 TC-808-MG	Ø 89.00mm Ø 89.00mm	1.20mm 1.20mm	±0.05 ±0.05 ±0.05 ±0.05

JD-780

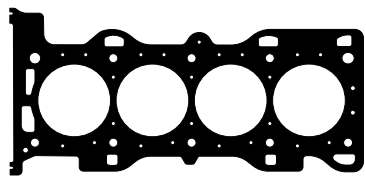

TC-808 - 6M8Z6051AA/AG/1355862
Junta Culata de Cilindros
Junta Cabeçote



2757000 - 1S7Z9E9360A
Válvula mariposa aceleración
Válvula borboleta aceleração



JSA-307
1S719451AA/1133143
Salida Escape
Saída Escapamento



2757200 - 1S7Z8255BC
Válvula termostato
Válvula termostato



JAE-416-E - 1S7Z9448AA
Junta Escape
Junta Escapamento



JAE-417-A - 1S7Z9439AA
Juego Admisión
Jogo Admissão



2756900
Caja mariposa
Caixa borboleta



2756800 - 1S7Z9F670AA
Válvula reguladora paso a paso
Válvula reguladora passo a passo

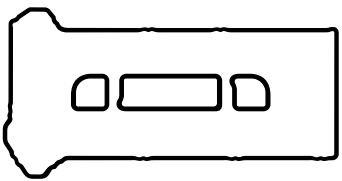

JVS-348-43 - 1220025/LF0210230
Junta Tapa Válvula Superior
Junta Tampa Válvula Superior



1003600 - 1S7Z6659AA
Base bomba de aceite
Base bomba de óleo



1004100 - 1119275
Conexión salida agua
Conexão saída água

RT-894Vit
Juego Retenes Guía de Válvulas
Jogo Retentor da Haste de Válvulas



2757300 - 1S7Z6B752AA
Separador bomba aceite
Separador bomba óleo



2713500 - 1119277
O'ring bomba agua
64 x 3mm



1004000 - 1S7Z6840AA
Base filtro aceite
Base filtro óleo



1187200 - 1355115
Válvula EGR



1187300
Arandela (acero inoxidable)
Arruela (aço inoxidável)
2,6 x 3,2 mm



2757400 - 1119253
Chupador bomba de aceite
Pescador bomba de óleo

RT-2986Pol
Retén Distribución
Retentor Dianteiro do Virabrequim
37,00 x 50,00 x 8,00

Productos relacionados no incluidos en el juego. Los mismos pueden ser solicitados por separado.
Produtos relacionados não incluídos no jogo. Podem ser solicitados em separado.
Related products that were not included in the set but can be ordered separately.

RT-3005
Porta Retén Bancada
Flange Traseiro do Virabrequim
88 x 169,6 x 14

Juego Completo de Reparación:

Jogo de Juntas do Motor / Full Set Gasket:

JR-250-15**R****Semi-Juego de Reparación:**

Semi-Jogo de Juntas / Semi-Set Gasket:

Juego de Descarbonización:

Jogo de Juntas Superior / Head Set Gasket:

JD-117-15**R**

JUNTA CULATA DE CILINDROS	TC-421-15	∅ 98.30mm	1.60mm	↑ ↓
Junta de cabeçote				↑ ↓
Cylinder Head gasket				↑ ↓

DESCRIPCIÓN / Descrição / Description

FORD: Taunus - Sierra - XR4 - GXL/GT
 SP/Ghia - Coupe 1974/81 - Mustang 1980/...
 Maverick 1975/79 - Falcon 1974/...

MOTOR / Engine	CM ³	HP	∅ PISTON
OHC	2299	100/114	96.00

ILLINOIS

FORD

**JD-117-15**

TC-421-15 - DSFZ6051A/76BR6051A
 Junta Culata de Cilindros
 Junta Cabeçote



JAE-303-A - 74BR9439A
 Junta Admisión
 Junta Admissão



JAE-311-E - 74BR9430A/78BR9448A
 Junta Escape
 Junta Escapamento



JSA-165 - 2638526
 Salida Escape
 Saída Escapamento

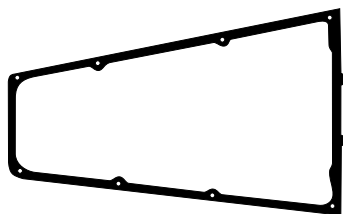

JVS-201-30 - 74BR6584B
 Junta Tapa Válvula Superior
 Junta Tampa Válvula Superior



1042900 - 74BR8255A
 Termostato
 Termostato



RT-506PoI
 Juego Retenes Guía de Válvulas
 Jogo Retentor da Haste de Válvulas

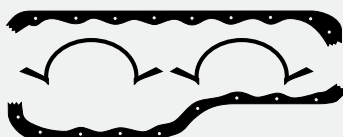

JC-244-30 - 74BR6710/11
 Junta Cáster
 Junta Carter



1042700 - 74BR6020A
 Tapa distribución
 Tampa distribuição



1043000 - 74BR8507A
 Bomba de agua
 Bomba de água



1042800 - 74BR6625A
 Bomba de aceite
 Bomba de óleo



1043100 - 74BR9417A
 Bomba de combustible
 Bomba de combustível



RT-8010PoI
 Retén Bancada
 Retentor Traseiro do Virabrequim
 Lx-Hel 92,00 x 108,00 x 9,80



RT-6684PoI
 Retén Reforma Bancada
 Retentor Reforma Traseiro do Virabrequim
 Lx-Hel 92,00 x 106,50 x 5,40



RT-6680PoI
 Retén Distribución
 Retentor Dianteiro do Virabrequim
 A 083-R 43,40 x 56,10 x 9,00

Productos relacionados no incluidos en el juego. Los mismos pueden ser solicitados por separado.

Produtos relacionados não incluídos no jogo. Podem ser solicitados em separado.

Related products that were not included in the set but can be ordered separately.



JV-142
 Juego Caja Velocidad
 Jogo Caixa de Câmbio



JB-197
 Juego Carburador
 Jogo Carburador



JB-201
 Juego Carburador
 Jogo Carburador



JB-204
 Juego Carburador
 Jogo Carburador

DESCRIPCIÓN / Descrição / Description

DIESEL

FORD: Transit TD 2000/...

MOTOR / Engine	CM ³	HP	Ø PISTON
Duratorq 16V	2402	120/125	89.90

Juego Completo de Reparación:

Jogo de Juntas do Motor / Full Set Gasket:

Semi-Juego de Reparación:

Semi-Jogo de Juntas / Semi-Set Gasket:

SJ-567

Juego de Descarbonización:

Jogo de Juntas Superior / Head Set Gasket:

JD-567-ST

JUNTA CULATA DE CILINDROS	TC-819-MG 1M	Ø 91.00mm	1.10mm	±0.05
Junta de cabeçote	TC-819-MG 2M	Ø 91.00mm	1.20mm	±0.05
Cylinder Head gasket	TC-819-MG 3M	Ø 91.00mm	1.30mm	±0.05

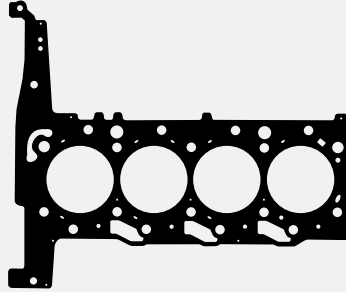

TC-819-MG 1M - 1096227/1256146/1349874/5C1Q6051AA
TC-819-MG 2M - 1096228/1256130/1349875/5C1Q6051BA
TC-819-MG 3M - 1096230/1256149/1349876/5C1Q6051CA
 Junta Culata de Cilindros/Junta Cabeçote

JD-567-ST

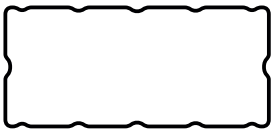

JVS-414-43 - 1099778/1143176/0249E9
 Junta Tapa Válvula Superior
 Junta Tampa Válvula Superior



JAE-609-A - 1138392/9661743180/0348T1
 Juego Admisión
 Jogo Admissão



2703500 - 1738590
 Anillo Admisión
 Anel Admissão



1403200
 Junta



JAE-610-E - 1120402/1137860
 Junta Escape
 Junta Escapamento



2704800 - 1098228
 Termostato



1403400
 Junta

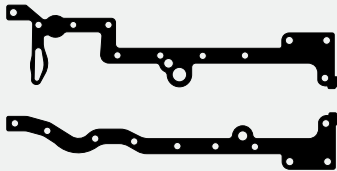

JC-402-15 - 1228836/112953
 Junta Cártel
 Junta Carter

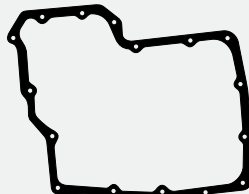

JC-403-25
 Junta Cártel Intermedia
 Junta Carter Intermediária

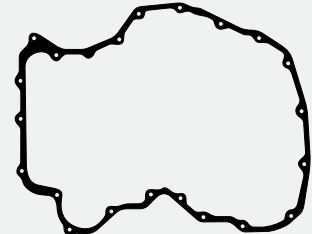

1185000 - 1102681
 Frente Distribución
 Frente Distribuição



1156800 - 1094599
 Bomba inyectora
 Bomba injetora



1199400 - 1121210
 Distribución a block
 Distribuição ao bloco



1403300
 Junta



1198000 - 1322526/1107599/
 4C1Q8K525AB/YC1Q8K525AC
 Tubo refrigerante
 Tubo refrigeração



1403500
 Junta

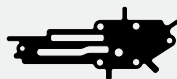

1403600
 Filtro de aceite
 Filtro de óleo



1194200 - 1105321
 Chupador aceite
 Pescador óleo



1196600 - 1146959
 Bomba vacío
 Bomba vácuo

Productos relacionados no incluidos en el juego. Los mismos pueden ser solicitados por separado.

Produtos relacionados não incluídos no jogo. Podem ser solicitados em separado.

Related products that were not included in the set but can be ordered separately.

Juego Completo de Reparación:

Jogo de Juntas do Motor / Full Set Gasket:

JR-811-11

DESCRIPCIÓN / Descrição / Description

FORD: Ranger 2001/12 - Ecosport 2003/07
Mondeo 2002/06 (9E5Z6079B/9E5Z6E078A)**Semi-Juego de Reparación:**

Semi-Jogo de Juntas / Semi-Set Gasket:

Juego de Descarbonización:

Jogo de Juntas Superior / Head Set Gasket:

JUNTA CULATA DE CILINDROS	TC-642-11	Ø 91.00mm	0.60mm	↑ ↓
Junta de cabeçote				↑ ↓
Cylinder Head gasket				↑ ↓

MOTOR / Engine	CM ³	HP	Ø PISTON
GBVAF	2488	166	89.00
GBVAL	2488	166	89.00
GBVAK	2488	166	89.00
EV2GD Duratec	2488	166	89.00

ILLINOIS.

FORD

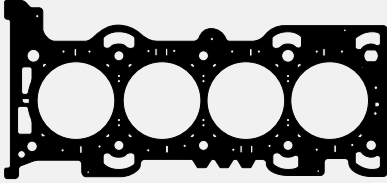
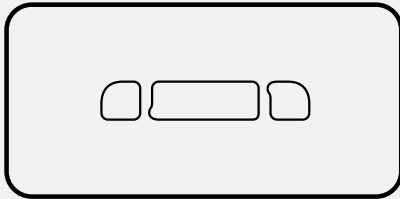
**TC-642-11 - 5201387/8E5E6051CE**
Junta Culata de Cilindros
Junta CabeçoteConexión salida agua
Conexão saída águaBase filtro aceite
Base filtro óleoJunta Escape
Junta EscapamentoJunta Admisión
Junta AdmissãoVálvula termostato
Válvula termostatoJunta Tapa Válvula Superior
Junta Tampa Válvula Superior

Junta

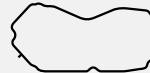
Separador bomba aceite
Separador bomba óleo

Válvula EGR

Juego Retenes Guía de Válvulas
Jogo Retentor da Haste de VálvulasRetén Distribución
Retentor Dianteiro do Virabrequim

Productos relacionados no incluidos en el juego. Los mismos pueden ser solicitados por separado.

Produtos relacionados não incluídos no jogo. Podem ser solicitados em separado.

Related products that were not included in the set but can be ordered separately.

DESCRIPCIÓN / Descrição / Description **DIESEL**

FORD: Transit - Transit D/DI 1985/99
Tourneo D/TD 1994/99

MOTOR / Engine	CM ³	HP	Ø PISTON
4EB/BC/CA/FB/CC/FA/FC/FD	2496	70/80	93.64
4HC/EA/HB/HC/EB/EC	2496	76/100	93.64
4CB	2496	70	93.64
4GA/GB/GC/FC/GB/GE/GD	2496	70/85	93.64

Juego Completo de Reparación:

Jogo de Juntas do Motor / Full Set Gasket:

Semi-Juego de Reparación:

Semi-Jogo de Juntas / Semi-Set Gasket:

SJ-273

R

Juego de Descarbonización:

Jogo de Juntas Superior / Head Set Gasket:

JD-717-ST

R

JUNTA CULATA DE CILINDROS	TC-201-20	Ø 96.00mm	1.40mm	±0.05
Junta de cabeçote	TC-201-MG	Ø 96.00mm	1.40mm	±0.05
Cylinder Head gasket				

JD-717

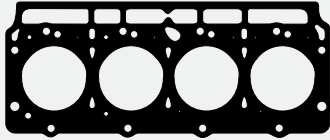

TC-201-20 TC-201-MG - 6518302
Junta Culata de Cilindros
Junta Cabeçote

JD-717-ST



JSA-288
Salida Escape
Saída Escapamento



1034800 - 6909744
Entre múltiples
Entre coletor



2618900
Arandela inyector
Arruela inyector
7,3 x 15,8 x 0,8mm (Cobre)



JAE-483-A - 6525915
Junta Admisión
Junta Admissão



JAE-482-E - 6193676
Junta Escape
Junta Escapamento



1034700
Acople termostato
Acoplamento termostato



2714900
Arandela tapa de válvula
Arruela tampa de válvula
8,5 x 13,4 x 5mm



JVS-321-30 - 6201251
Junta Tapa Válvula Superior
Junta Tampa Válvula Superior



1168000 - 6175933
Válvula reguladora de gases
Válvula reguladora de gases



1034100
Termostato
Termostato



RT-2901Sil
Juego Ret. Guía de Válvulas
Jgo. Retenedor da Haste de Válv.

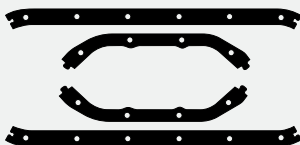

JC-347-30 - 6193087
Junta Cáster
Junta Carter

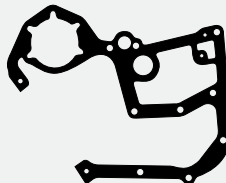

1033500 - 6193530
Placa distribución
Placa distribuição



1034000
Porta retén
Porta retentor



1033700 - 6182958
Tapa distribución
Tampa distribuição



2710000 - 1166041
O'ring 30 x 3,53mm
Goma bancada delantera (0130)
Borracha mancal dianteira



2714600 - ERR4685B
O'ring 21 x 3mm



2714500
O'ring 18 x 3mm



2714400
O'ring 19 x 3mm



1034200
Brida
Flange



2714700
O'ring 70 x 3mm



1177500
Bomba de agua a distribución
Bomba de água de distribuição



1034500
Calefactor
Aquecedor



1033800 - 6771114
Tapa bomba de agua
Tampa bomba de água



RT-9623Vit
Retén Árbol de Levas
Retenedor do Eixo Comando de Válv.
Lx-R H 47,60 x 66,70 x 11,30



RT-9872Vit
Retén Distribución
Retenedor Dianteiro do Virabrequim
Mx-R 66,70 x 85,70 x 10,00



RT-9870Vit
Retén Bancada
Retenedor Traseiro do Virabrequim
Mx-R 79,00 x 99,00 x 9,60

2619000 - Juego Arandelas Metálicas/Jogo Arruelas Metálicas

Gráfico	Descripción/Descrição	Cant./Quant.
	Arand./Arruela 19x27x1,5mm Alum.	1
	Arand./Arruela 15x21x2mm Alum.	2
	Arand./Arruela 14x19x1,5mm Alum.	8
	Arand./Arruela 12x18x1,5mm Alum.	6
	Arand./Arruela 10x15x1,5mm Alum.	2
	Arand./Arruela 6x10x1mm Cobre	4

Productos relacionados no incluidos en el juego. Los mismos pueden ser solicitados por separado.

Produtos relacionados não incluídos no jogo. Podem ser solicitados em separado.

Related products that were not included in the set but can be ordered separately.



BU-014
Bulones para Culata de Cilindros
Parafusos de Cabeçote



JT-109
Juego Turbo
Jogo Turbo

Juego Completo de Reparación:

Jogo de Juntas do Motor / Full Set Gasket:

JR-161-15

DESCRIPCIÓN / Descrição / Description

FORD: Falcon 4B - STD - De Luxe - Futura Rural 1962/68

MOTOR / Engine

CM³

HP

Ø PISTON

170 4B

2780

84

88.90

187 4B

3052

96

90.42

Semi-Juego de Reparación:

Semi-Jogo de Juntas / Semi-Set Gasket:

Juego de Descarbonización:

Jogo de Juntas Superior / Head Set Gasket:

JUNTA CULATA DE CILINDROS	TC-250-15	Ø 97.30mm	1.50mm	↑ ↓	↑ ↓	↑ ↓	↑ ↓	↑ ↓	↑ ↓
Junta de cabeçote				↑ ↓	↑ ↓	↑ ↓	↑ ↓	↑ ↓	↑ ↓
Cylinder Head gasket				↑ ↓	↑ ↓	↑ ↓	↑ ↓	↑ ↓	↑ ↓

ILLINOIS

FORD

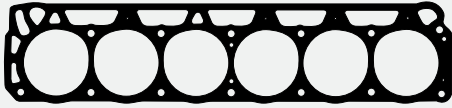
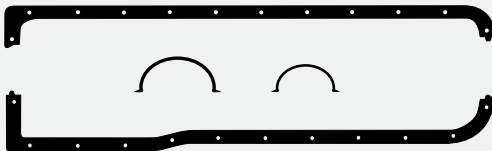
**TC-250-15 - BAD3DZ6051A**
Junta Culata de Cilindros
Junta Cabeçote**JSA-129 - CIDD9453/C6AZ9450D**
Salida Escape
Saída Escapamento**1041000 - CODE8255A**
Salida Termostato
Saída Termostato**JAE-202 - CODE9448A/BAC8DZ9448A**
Múltiple Admisión y Escape
Coletor Admissão e Escapamento**1042300 - BAC9DZ9447A**
Base carburador
Base carburador**1025000 - 2000425**
2016726/C3AZ9417C
Base bomba de nafta
Base bomba de gasolina**JVS-142-30 - CODE6584B**
Junta Tapa Válvula Superior
Junta Tampa Válvula Superior**1042100 - CODE8507A**
Bomba de agua
Bomba de água**1040700 - CODE6020C/BAC9DZ6020A**
Tapa distribución
Tampa distribuição**JC-171-30 - CODE6781A/BAC9DZ6781A**
Junta Cártar
Junta Carter**1041300 - CODE9516B**
Base carburador
Base carburador**1041500**
Base calefactora
Base aquecedora**1040800 - CODE6626A**
Bomba de aceite
Bomba de óleo**1041600**
Bomba de aceite 4 agujeros
Bomba de óleo 4 furos**RT-8098Pol**
Retén Reforma Bancada
Retentor Traseiro do Virabrequim
Lz-R 85,70 x 100,00 x 5,30**RT-6679Pol**
Retén Distribución
Retentor Dianteiro do Virabrequim
Mx-R 44,45 x 60,30 x 11,11**RT-505Pol**
Juego Retenes Guía de Válvulas
Jogo Retentor da Haste de Válvulas

Productos relacionados no incluidos en el juego. Los mismos pueden ser solicitados por separado

Produtos relacionados não incluídos no jogo. Podem ser solicitados em separado / Related products that were not included in the set but can be ordered separately.

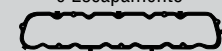
**BU-061**
Bolones para
Culata de Cilindros
Parafusos de Cabeçote**JSA-129-11**
CIDD9453/C6AZ9450D
Salida Escape
Saída Escapamento**RT-531Pol**
Capuchón Guía de Vál.
Capa haste de Válvulas**JB-140**
Jgo. Carburador
Jogo Carburador**JB-130**
Jgo. Carburador
Jogo Carburador**JAE-202-09**
Múltiple Admisión y Escape
Coletor Admissão e Escapamento**1041400 - CODE9516**
Interm. Carb. Bca. Chica
Intermediária carburador
bca. pequena 37mm**1042400 - BAC9DZ9516**
Interm. Carb. Bca. Grande
Intermediária carburador
bca. grande 40mm**1041700**
Cuba Carburador
Cuba Carburador
Sobremedida**1044600**
Cuba Carburador
Cuba Carburador**JVS-142-23**
Junta Tapa Válvula Superior
Junta Tampa Válvula Superior

DESCRIPCIÓN / Descrição / Description

FORD: Fusion 2009/12 - Maverick 2001/...
Mondeo (9L8Z6079B)

MOTOR / Engine	CM ³	HP	Ø PISTON
Duratec V6 24V	2967	197/226	89.00
AJ	2967	197	89.00
MEBA	2967	226	89.00

Juego Completo de Reparación:

Jogo de Juntas do Motor / Full Set Gasket:

JR-812-11



Semi-Juego de Reparación:

Semi-Jogo de Juntas / Semi-Set Gasket:

Juego de Descarbonización:

Jogo de Juntas Superior / Head Set Gasket:

JUNTA CULATA DE CILINDROS	TC-635-11	Ø 91.00mm	---mm	↑ ↓
Junta de cabeçote	TC-636-11	Ø 91.00mm	---mm	↑ ↓
Cylinder Head gasket				↑ ↓

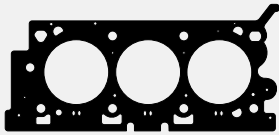

TC-635-11
 4832568/6E5E6051AA/AJ0310271
 Junta Culata de Cilindros (Derecha)
 Junta Cabeçote (Direita)

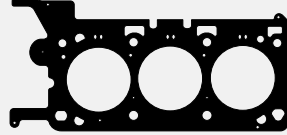

TC-636-11
 4921510/6F9E6083AB/AJ0310272
 Junta Culata de Cilindros (Izquierda)
 Junta Cabeçote (Esquerda)



Junta



Junta



Junta Escape
 Junta Escapamento



Junta Admisión
 Junta Admissão



Junta

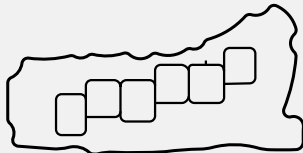

Junta Tapa Válvula Superior
 Junta Tampa Válvula Superior



Junta Tapa Válvula Superior
 Junta Tampa Válvula Superior



Junta



Junta Tapa Válvula Superior
 Junta Tampa Válvula Superior



Retén
 Retentor



Juego Retenes Guía de Válvulas
 Jogo Retentor da Haste de Válvulas



Retén Bancada
 Retentor Traseiro do Virabrequim



Retén Árbol de Leva
 Retentor do Eixo Comando de Válvulas



Retén Distribución
 Retentor Dianteiro do Virabrequim

Productos relacionados no incluidos en el juego. Los mismos pueden ser solicitados por separado.

Produtos relacionados não incluídos no jogo. Podem ser solicitados em separado.

Related products that were not included in the set but can be ordered separately.

Juego Completo de Reparación:

Jogo de Juntas do Motor / Full Set Gasket:

JR-164-15**R****Semi-Juego de Reparación:**

Semi-Jogo de Juntas / Semi-Set Gasket:

Juego de Descarbonización:

Jogo de Juntas Superior / Head Set Gasket:

JD-101-15**R**

JUNTA CULATA DE CILINDROS	TC-250-15	Ø 97.30mm	1.50mm	↕
Junta de cabeçote				↕
Cylinder Head gasket				↕

DESCRIPCIÓN / Descrição / Description

FORD: Falcon 7B - F100 - Fairlane 1969/...

MOTOR / Engine	CM ³	HP	Ø PISTON
187 7B	3052	108	90.62
188 7B	3075	108	93.47
221 7B	3618	108	93.47

ILLINOIS

FORD

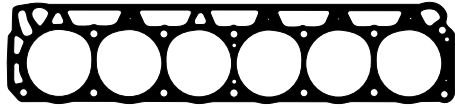
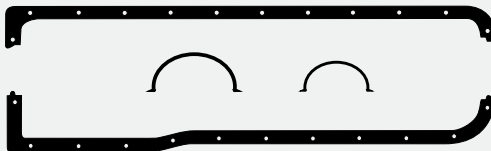
JD-101-15**TC-250-15 - BAD3DZ6051A**
Junta Culata de Cilindros
Junta Cabeçote**JAE-202 - CODE9448A/BAC8DZ9448A**
Múltiple Admisión y Escape
Coletor Admissão e Escapamento**JVS-142-30 - CODE6584B**
Junta Tapa Válvula Superior
Junta Tampa Válvula Superior**JSA-132 - C6AZ9450D/3696990**
7ZAU951A
Salida Escape
Saída Escapamento**1041000 - CODE8255A**
Entrada agua
Entrada água**1041500**
Base calefactora
Base aquecedora**1042300 - BAC9DZ9447A**
Base carburador
Base carburador**1041300 - CODE9516B**
Intermedia carburador
Intermediária carburador**RT-505PoI**
Juego Retenes Guía de Válvulas
Jogo Retentor da Haste de Válvulas**JC-172-30 - BAC9DZ6781A**
Junta Carter
Junta Carter**1040700 - CODE6020C**
BAC9DZ6020A
Tapa distribución
Tampa distribuição**1042100 - CODE8507A**
Bomba de agua
Bomba de água**1040800 - CODE6626A**
Bomba de aceite
Bomba de óleo**1041600**
Bomba de aceite 4 agujeros
Bomba de óleo 4 furos**1025000 - 2000425**
2016726/C3AZ9417C
Base bomba de nafta
Base bomba de gasolina**RT-8237PoI**
Retén Bancada
Retentor Traseiro do Virabrequim
Lx-Hel 85,70 x 102,62 x 9,73**RT-8098PoI**
Retén Reforma Bancada
Retentor Reforma Traseiro do Virabrequim
Lz-R 85,70 x 100,00 x 5,30**RT-6679PoI**
Retén Distribución
Retentor Dianteiro do Virabrequim
Mx-R 44,45 x 60,30 x 11,11

Productos relacionados no incluídos en el juego. Los mismos pueden ser solicitados por separado

Produtos relacionados não incluídos no jogo. Podem ser solicitados em separado / Related products that were not included in the set but can be ordered separately.

**BU-061**
Bulones para Culata de Cilindros
Parafusos de Cabeçote**1044600**
Cuba Carburador
Cuba Carburador**JB-140**
Juego Carburador
Jogo Carburador**JB-141**
Juego Carburador
Jogo Carburador**JSA-171-22**
Salida Escape
Saída Escapamento
(Fundición/Ferro)**JSA-171-21**
Salida Escape
(Anillo Malla Acero)
Saída Escapamento
(Anel Malha Aço)**JC-172-15**
Junta Carter
Junta Carter**RT-531PoI**
Capuchón Guía de Válvulas
Capa haste de Válvula**JV-130**
Juego Caja Veloc.
Jogo Caixa de Câmbio**JB-236**
Juego Carburador
Jogo Carburador**JB-183**
Juego Carburador
Jogo Carburador**JB-190**
Juego Carburador
Jogo Carburador**1042400**
Intermedia Carburador
Bca. Grande 40mm**JAE-202-09**
Múltiple Admisión y Escape
Coletor Admissão e Escapamento**JVS-142-23**
Junta Tapa Válvula Superior
Junta Tampa Válvula Sup.

DESCRIPCIÓN / Descrição / Description **DIESEL**

FORD: Ranger XLS/XLT 4x2/4x4 TDCi 2013/...

MOTOR / Engine	CM ³	HP	Ø PISTON
Puma TDCi eTGV	3198	200	90.00

Juego Completo de Reparación:

Jogo de Juntas do Motor / Full Set Gasket:

Semi-Juego de Reparación:

Semi-Jogo de Juntas / Semi-Set Gasket:

SJ-561

Juego de Descarbonización:

Jogo de Juntas Superior / Head Set Gasket:

JD-561-ST

JUNTA CULATA DE CILINDROS	TC-696-MG 2M	Ø 91.00mm	1.15mm
Junta de cabeçote	TC-696-MG 3M	Ø 91.00mm	1.20mm
Cylinder Head gasket	TC-696-MG 4M	Ø 91.00mm	1.25mm

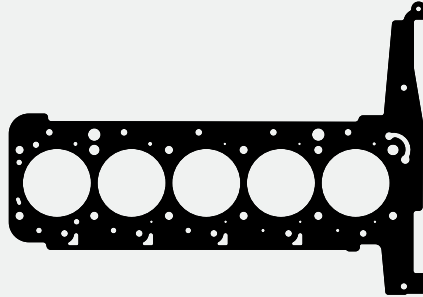

TC-696-MG 2M - 1720353/1459471/BB3Q6051B1A
TC-696-MG 3M - 1720354/1459472/BB3Q6051C1A
TC-696-MG 4M -
 Junta Culata de Cilindros/Junta Cabeçote

JD-561-ST

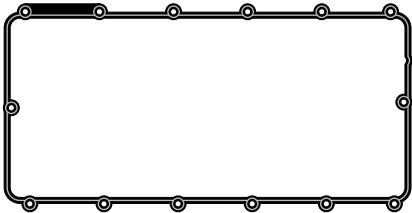

JVS-368-43 - 1760800
 Junta Tapa Válvula Superior
 Junta Tampa Válvula Superior



JAE-619-A - 1138392/9661743180/0348T1
 Juego Admisión
 Jogo Admissão



2703500 - 1738590
 Anillo Admisión
 Anel Admissão



JAE-620-E - 1712448
 Junta Escape
 Junta Escapamento



2704800 - 1098228
 Termostato

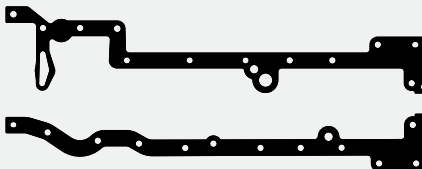

JC-404-15 - 11748634/1508582
 Junta Cártel
 Junta Carter

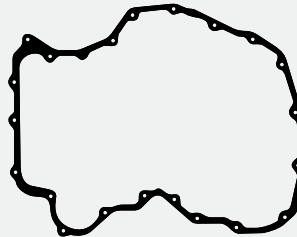

1185000 - 1102681
 Frente Distribución
 Frente Distribuição



1198000 - 1322526/1107599/
 4C1Q8K525AB/YC1Q8K525AC
 Tubo refrigerante
 Tubo refrigeração



1156800 - 1094599
 Bomba inyectora
 Bomba injetora



1199400 - 1121210
 Distribución a block
 Distribuição ao bloco



1196600 - 1146959
 Bomba vacío
 Bomba vácuo



1177500 - 1096559
 Bomba de agua
 Bomba de água



2701100 - 1721342
 Filtro de aceite
 Filtro de óleo



1194200 - 1105321
 Chupador aceite
 Pescador óleo

Productos relacionados no incluidos en el juego. Los mismos pueden ser solicitados por separado.

Produtos relacionados não incluídos no jogo. Podem ser solicitados em separado.

Related products that were not included in the set but can be ordered separately.

Juego Completo de Reparación:

Jogo de Juntas do Motor / Full Set Gasket:

JR-813-11

DESCRIPCIÓN / Descrição / Description

FORD: Edge SEL 2009/16 - Explorer 2011/18**Semi-Juego de Reparación:**

Semi-Jogo de Juntas / Semi-Set Gasket:

Juego de Descarbonización:

Jogo de Juntas Superior / Head Set Gasket:

JUNTA CULATA DE CILINDROS	TC-631-11	∅	--mm	∞	--mm	∞	∞	∞	∞	∞	∞
Junta de cabeçote	TC-632-11	∅	--mm	∞	--mm	∞	∞	∞	∞	∞	∞
Cylinder Head gasket		∅		∞		∞	∞	∞	∞	∞	∞

MOTOR / Engine	CM ³	HP	∅ PISTON
213 CID	3496	269	92.50

ILLINOIS.

FORD

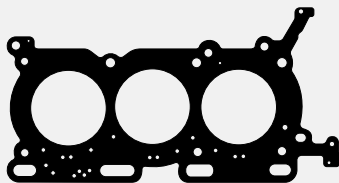
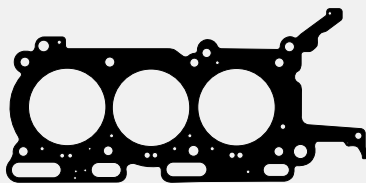
**TC-631-11**Junta Culata de Cilindros (Derecha)
Junta Cabeçote (Direita)**TC-632-11**Junta Culata de Cilindros (Izquierda)
Junta Cabeçote (Esquerda)Junta Admisión
Junta AdmissãoJunta Escape
Junta EscapamentoJunta Admisión
Junta AdmissãoJunta Tapa Válvula Superior
Junta Tampa Válvula SuperiorJunta Tapa Válvula Superior
Junta Tampa Válvula Superior

Junta



Junta

Juego Retenes Guía de Válvulas
Jogo Retentor da Haste de VálvulasRetén Distribución
Retentor Dianteiro do Virabrequim

Productos relacionados no incluidos en el juego. Los mismos pueden ser solicitados por separado.

Produtos relacionados não incluídos no jogo. Podem ser solicitados em separado.

Related products that were not included in the set but can be ordered separately.

DESCRIPCIÓN / Descrição / Description

FORD: Falcon SP - Sprint 7B 1973/...

MOTOR / Engine	CM ³	HP	Ø PISTON
221 Sprint SP	3618	132	93.47

Juego Completo de Reparación:

Jogo de Juntas do Motor / Full Set Gasket:

JR-268-15

R

Semi-Juego de Reparación:

Semi-Jogo de Juntas / Semi-Set Gasket:

Juego de Descarbonización:

Jogo de Juntas Superior / Head Set Gasket:

JUNTA CULATA DE CILINDROS	TC-250-15	Ø 97.30mm	1.50mm	1.50mm	1.50mm
Junta de cabeçote		Ø			
Cylinder Head gasket		Ø			

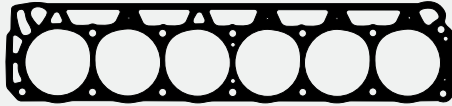

TC-250-15 - BAD3DZ6051A
Junta Culata de Cilindros
Junta Cabeçote



1043900 - B7A9364A
Vaso bomba de nafta
Copo bomba gasolina



JSA-165 - 2638526
Salida Escape
Saída Escapamento



JAE-309 - BAD3DZ9448A
Multiple Admisión y Escape
Coletor Admissão e Escapamento



1040800 - CODE6626A
Bomba de aceite
Bomba de óleo



1044200 - B9AE9447A
BAD00Z9447A
Base carburador
Base carburador



JVS-142-30 - CODE6584B
Junta Tapa Válvula Superior
Junta Tampa Válvula Superior



1041000 - CODE8255A
Entrada agua
Entrada água



1041600
Bomba de aceite 4 agujeros
Bomba de óleo 4 furos

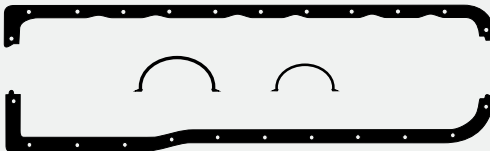

JC-172-30 - BAC9DZ6781A
Junta Cártter
Junta Carter



1040700 - CODE6020C/BAC9DZ6020A
Tapa distribución
Tampa distribuição



1042100 - CODE8507A
Bomba de agua
Bomba de água



RT-505Pol
Juego Retenes Guía de Válvulas
Jogo Retentor da Haste de Válvulas



RT-6679Pol
Retén Distribución
Ret. Dianteiro do Virabrequim
Mx-R 44,45 x 60,30 x 11,11



1025000 - 2000425
2016726/C3AZ9417C
Base bomba de nafta
Base bomba de gasolina



RT-8237Pol
Retén Bancada
Retentor Traseiro do Virabrequim
Lx-Hel 85,70 x 102,62 x 9,73



RT-8098Pol
Retén Reforma Bancada
Ret. Reforma Tras. do Virabrequim
Lz-R 85,70 x 100,00 x 5,30

Productos relacionados no incluidos en el juego. Los mismos pueden ser solicitados por separado.

Produtos relacionados não incluídos no jogo. Podem ser solicitados em separado.

Related products that were not included in the set but can be ordered separately.



BU-061
Bulones para Culata de Cilindros
Parafusos de Cabeçote



JB-191
Juego Carburador
Jogo Carburador



RT-531Pol
Capuchón
Guía de Válvulas
Capa haste de Válvulas



JVS-142-23
Junta Tapa Válvula Superior
Junta Tampa Válvula Superior



JC-172-15
JC-172-23
Junta Cártter
Junta Carter

Juego Completo de Reparación:

Jogo de Juntas do Motor / Full Set Gasket:

JR-337-15**R****Semi-Juego de Reparación:**

Semi-Jogo de Juntas / Semi-Set Gasket:

Juego de Descarbonización:

Jogo de Juntas Superior / Head Set Gasket:

JD-146-15**R**

JUNTA CULATA DE CILINDROS	TC-250-15	Ø 97.30mm	1.50mm	↑ ↓
Junta de cabeçote				↑ ↓
Cylinder Head gasket				↑ ↓

DESCRIPCIÓN / Descrição / Description

FORD: Falcon GL - Pick Up F100 1989/...

MOTOR / Engine	CM ³	HP	Ø PISTON
Max Econo 7B	3618	106	93.47

ILLINOIS

FORD

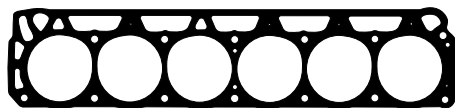
JD-146-15

TC-250-15 - BAD3DZ6051A
Junta Culata de Cilindros
Junta Cabeçote



1041000 - CODE8255A
Entrada agua
Entrada água



JAE-344 - BAC9DZ9448A
Múltiple Admisión y Escape
Coletor Admissão e Escapamento



JSA-191-22
Salida Escape (Fundición)
Saída Escapamento (Ferro)



JVS-142-30 - CODE6584B
Junta Tapa Válvula Superior
Junta Tampa Válvula Superior



RT-505Pol
Juego Retenes Guía de Válvulas
Jogo Retentor da Haste de Válvulas

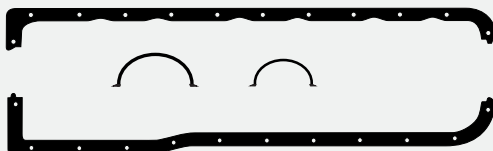

JC-172-30 - BAC9DZ6781A
Junta Carter
Junta Carter



1041600
Bomba de aceite 4 agujeros
Bomba de óleo 4 furos



1040700 - CODE6020C/BAC9DZ6020A
Tapa distribución
Tampa distribuição



1040800 - CODE6626A
Bomba de aceite
Bomba de óleo



1025000 - 2000425
2016726/C3AZ9417C
Base bomba de nafta
Base bomba de gasolina



1042100 - CODE8507A
Bomba de agua
Bomba de água



RT-8237Pol
Retén Bancada
Retentor Traseiro do Virabrequim
Lx-Hel 85,70 x 102,62 x 9,73



RT-8098Pol
Retén Reforma Bancada
Retentor Reforma Traseiro do Virabrequim
Lz-R 85,70 x 100,00 x 5,30



RT-6679Pol
Retén Distribución
Retentor Dianteiro do Virabrequim
Mx-R 44,45 x 60,30 x 11,11

Productos relacionados no incluidos en el juego. Los mismos pueden ser solicitados por separado
Produtos relacionados não incluídos no jogo. Podem ser solicitados em separado / Related products that were not included in the set but can be ordered separately.



BU-061
Bulones para
Culata de Cilindros
Parafusos de Cabeçote



JB-218
Juego Carburador
Jogo Carburador



RT-531Pol
Capuchón
Guía de Válvulas
Capa haste de Válvulas



JSA-191-21
Salida Escape
(Anillo Malla Acero)
Saída Escapamento
(Anel Malha Aço)



JVS-142-23
Junta Tapa Vál. Superior
Junta Tampa Válvula Sup.



JC-172-15
JC-172-23
Junta Carter
Junta Carter

DESCRIPCIÓN / Descrição / Description			
FORD: F100 - 350 - 600 - Fairlane 1961/70 Fase I			
MOTOR / Engine	CM ³	HP	Ø PISTON
272 - V8 Fase I	4458	170	92.00
292 - V8 Fase I	4785	170	95.25

Juego Completo de Reparación: Jogo de Juntas do Motor / Full Set Gasket:	JR-166-15	R		
Semi-Juego de Reparación: Semi-Jogo de Juntas / Semi-Set Gasket:				
Juego de Descarbonización: Jogo de Juntas Superior / Head Set Gasket:				
JUNTA CULATA DE CILINDROS Junta de cabeçote Cylinder Head gasket	TC-256-15	Ø 98.00mm	1.80mm	↕
		Ø	↕	↕
		Ø	↕	↕
		Ø	↕	↕

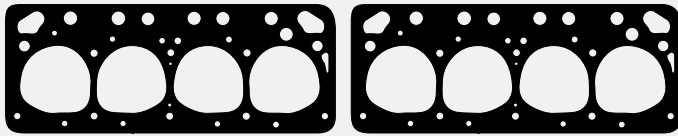

TC-256-15 - B6A6051A
Junta Culata de Cilindros
Junta Cabeçote



JSA-126 - 1GA9450A
Acople Múltiple Escape
Acoplamento Múltiplo Escapamento



JSA-125 - 1GA9450
Salida Escape
Saída Escapamento



JAE-206-A - B6T943941A
Juego Admisión
Jogo Admissão



1043600 - B5A8255A
Termostato
Termostato



1043800 - EAN8563B
Salida agua
Saída água



JAE-205-E - ZEAN9433
Juego Escape
Jogo Escapamento



1043300 - COAE6521A/B6A6521A
Tapa lateral botadores
Tampa lateral tuchos



1043900 - B7A9364 A
Vaso bomba de nafta
Copo bomba de gasolina



JVS-146-30 - COAE6584A
Junta Tapa Válvula Superior
Junta Tampa Válvula Superior



1175900 - B5A9417A
Bomba de nafta
Bomba de gasolina



1043700 - A5A8507A
Bomba de agua
Bomba de água



JC-175-30 - BGA6710
Junta Cártel
Junta Carter



1043200 - B4A6020A
Tapa distribución
Tampa distribuição



2729800 - B9A6570A
Arandela tapa de válvula
Arruela tampa de válvula



RT-507PoI
Juego Retenes Guía de Válvulas
Jogo Retentor da Haste de Válvulas



RT-6686PoI
Retén Distribución
Retentor Dianteiro do Virabrequim
Lz-Hel 47,63 x 64,95 x 8,28



1043400 - B6Q6659A
Bomba de aceite
Bomba de óleo

Productos relacionados no incluidos en el juego. Los mismos pueden ser solicitados por separado
Produtos relacionados não incluídos no jogo. Podem ser solicitados em separado / Related products that were not included in the set but can be ordered separately.



1086600 - B47Z1001A
Junta Palier
Junta Palier



1132100 - RTPJP1
Junta Palier
Junta Palier



1149900
Junta Palier
Junta Palier



JSA-126-11 - 1GA9450A
Acople Múltiple Escape
Acoplamento Múlt. Escapamento



JSA-125-11 - 1GA9450
Salida Escape
Saída Escapamento



JB-142
Juego Carburador
Jogo Carburador



JV-132
Juego Caja Vel.
Jogo Caixa de Câmb.

Juego Completo de Reparación:

Jogo de Juntas do Motor / Full Set Gasket:

JR-259-15**R**

DESCRIPCIÓN / Descrição / Description

**FORD: F100 - 350 - 600 - Fairlane 1/8
LTD 500 - Fase II 1969/76**

MOTOR / Engine	CM ³	HP	Ø PISTON
V8 Fase II	4785	180	95.25

ILLINOIS

FORD

Juego de Descarbonización:

Jogo de Juntas Superior / Head Set Gasket:

JUNTA CULATA DE CILINDROS	TC-419-15	Ø 102.30mm	1.80mm	1.80mm	1.80mm	1.80mm	1.80mm
Junta de cabeçote	TC-420-15	Ø 102.30mm	1.80mm	1.80mm	1.80mm	1.80mm	1.80mm
Cylinder Head gasket		Ø					

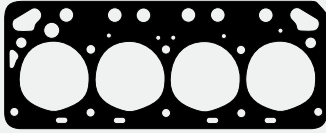

TC-420-15 - BAD0AZ6051B
Junta Culata de Cilindros (Izquierda)
Junta Cabeçote (Esquerda)

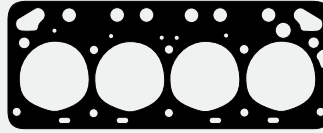

TC-419-15 - BAD0AZ6051A
Junta Culata de Cilindros (Derecha)
Junta Cabeçote Direita



JSA-126 - 1GA9450A
Acople Múltiple Escape
Acoplamento Múltiplo Escapamento



JAE-305-A - BAD0AZ9339
Juego Admisión
Jogo Admissão

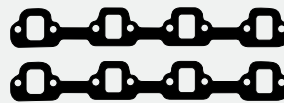

JAE-307-E - BAD0TZ9433
Juego Escape
Jogo Escapamento



JSA-125 - 1GA9450
Salida Escape
Saída Escapamento

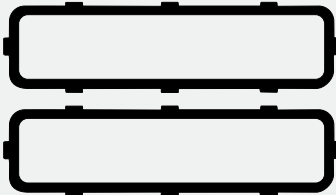

JVS-146-30 - COAE6584A
Junta Tapa Válvula Superior
Junta Tampa Válvula Superior



JC-175-30 - BGA6710
Junta Carter
Junta Carter

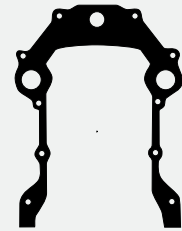

1043200 - B4A6020A
Tapa distribución
Tampa distribuição



1043300 - COAE6521A/B6A6521A
Tapa lateral botadores
Tampa lateral tuchos



1043700 - A5A8507A
Bomba de agua
Bomba de água



1043400 - B6Q6659A
Bomba de aceite
Bomba de óleo



1175900 - B5A9417A
Bomba de nafta
Bomba de gasolina



2729800 - B9A6570A
Arandela tapa de válvula
Arruela tampa de válvula



1043800 - EAN8563B
Salida agua
Saída água



1043900 - B7A9364A
Vaso bomba de nafta
Copo bomba de gasolina



1044700 - BAC90Z6A636A
Bomba de aceite
Bomba de óleo



1043600 - B5A8255A
Termostato
Termostato



RT-507Pol
Juego Ret. Guía de Válvulas
Jogo Retentor da Haste de Válvulas



RT-6686Pol
Retén Distribución
Retentor Dianteiro do Virabrequim
Lz-Hel 47,63 x 64,95 x 8,28

Productos relacionados no incluidos en el juego. Los mismos pueden ser solicitados por separado

Produtos relacionados não incluídos no jogo. Podem ser solicitados em separado / Related products that were not included in the set but can be ordered separately.



1086600 - B47Z1001A
Junta Palier
Junta Palier



1132200 - RTPJP2
Junta Palier
Junta Palier



1149900
Junta Palier
Junta Palier



JSA-126-11 - 1GA9450A
Acople Múltiple Escape
Acoplamento Mult. Escap.



JSA-125-11 - 1GA9450
Salida Escape
Saída Escapamento



JV-132
Juego Caja Vel.
Jogo Caixa de Câmbio



JB-143
Juego Carb.
Jogo Carb.

DESCRIPCIÓN / Descrição / Description

FORD: F100 - 150 1991/...

MOTOR / Engine	CM ³	HP	Ø PISTON
300 CID Inyección	4900	145	101.60

Juego Completo de Reparación:

Jogo de Juntas do Motor / Full Set Gasket:

JR-476-15



Semi-Juego de Reparación:

Semi-Jogo de Juntas / Semi-Set Gasket:

SJ-472

Juego de Descarbonización:

Jogo de Juntas Superior / Head Set Gasket:

JD-476-15

JUNTA CULATA DE CILINDROS	TC-543-15	Ø 105.50mm	1.20mm	±0.05
Junta de cabeçote				
Cylinder Head gasket				



JD-476-15



TC-543-15 - FOUZ6051A
Junta Culata de Cilindros
Junta Cabeçote



1004800
Entrada aire
Entrada ar



JAE-535-E - E7TZ9H486B
Junta Escape
Junta Escapamento



JAE-536-A - E7TZ9439A
Junta Admisión
Junta Admissão



2702700
O'ring 28 x 3,5mm

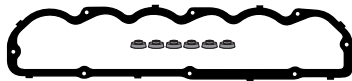

JVS-345-30
Junta Tapa Válvula Superior c/arandelas
Junta Tampa Válvula Superior c/arruelas



JVL-166-30 - E4TZ6521A
Junta Tapa Válvula Lateral
Junta Tampa Válvula Lateral



1004700 - E6FZ90476A
Válvula ERG

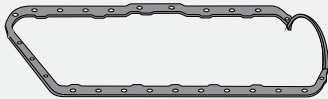

JC-371-30 - E7TZ6710B
Junta Cártér
Junta Carter



1004200 - E6TZ6020B
Tapa distribución
Tampa distribuição



1004300 - C5AZ8507A
Bomba de agua
Bomba de água



1004400 - E67Z8255B
Termostato
Termostato



1004500 - E7TZ9E936B
Válvula mariposa
Válvula borboleta



1004600 - E0TZ6626A
Aspiración bomba aceite
Aspiração bomba óleo



1004900
Arandela 67 x 80 x 1,6mm
Arruela



2611000
Arandela blindada 14 x 18 x 2,5mm
Arruela blindada (Cobre)



2634700
Arandela 12,8 x 22,8 x 2mm
Arruela (Fibra)



RT-6753PoI
Retén Distribución
Retentor Dianteiro do Virabrequim
MZ-L 47,65 x 65,20 x 11,90

Productos relacionados no incluidos en el juego. Los mismos pueden ser solicitados por separado.

Produtos relacionados não incluídos no jogo. Podem ser solicitados em separado.

Related products that were not included in the set but can be ordered separately.

Juego Completo de Reparación:

Jogo de Juntas do Motor / Full Set Gasket:

JR-153-05

DESCRIPCIÓN / Descrição / Description

FORD: T 1926/27**Semi-Juego de Reparación:**

Semi-Jogo de Juntas / Semi-Set Gasket:

Juego de Descarbonización:

Jogo de Juntas Superior / Head Set Gasket:

JUNTA CULATA DE CILINDROS	TC-233-05	∅ 98.00mm	1.80mm	↑ ↓
Junta de cabeçote				↑ ↓
Cylinder Head gasket				↑ ↓

MOTOR / Engine	CM ³	HP	∅ PISTON
3 3/4 x 4	2900	20	

ILLINOIS.

FORD

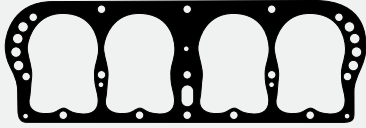

TC-233-05
Junta Culata de Cilindros
Junta Cabeçote



1018200 - T3381
Cubierta del Bendix
Cobertura do Bendix



1017700 - T5056
Cubierta transmisión
Cobertura transmissão



JAE-196
Múltiple Admisión y Escape
Coletor Admissão e Escapamento



1018300 - T3111
Tapa de válvula
Tampa válvula

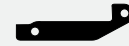

1017600 - T3102C
Interior cárter
Interior carter



JC-157-30 - T6781
Junta Cárter
Junta Carter



1018400 - T3017
Tapa distribución
Tampa distribuição

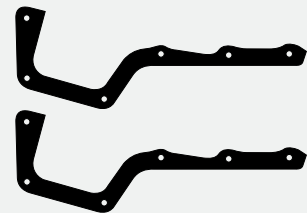

1017500 - T3377
Caja de velocidad
Jogo Caixa de Câmbio

Productos relacionados no incluidos en el juego. Los mismos pueden ser solicitados por separado.

Produtos relacionados não incluídos no jogo. Podem ser solicitados em separado.

Related products that were not included in the set but can be ordered separately.

DESCRIPCIÓN / Descrição / Description

HAFEI: Towner Jr. - YRV Jr.

MOTOR / Engine

CD 8V

CM³

970

HP

48

Ø PISTON

65.50

Juego Completo de Reparación:

Jogo de Juntas do Motor / Full Set Gasket:

JR-737-07



Semi-Juego de Reparación:

Semi-Jogo de Juntas / Semi-Set Gasket:

Juego de Descarbonización:

Jogo de Juntas Superior / Head Set Gasket:

JUNTA CULATA DE CILINDROS	TC-730-07	Ø 67.00mm	1.60mm	↑ ↓
Junta de cabeçote	TC-730-15	Ø 67.50mm	1.20mm	↑ ↓
Cylinder Head gasket				↑ ↓

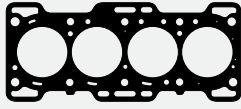

TC-730 - 1114175101/2
Junta Culata de Cilindros
Junta Cabeçote



Junta



Junta Inspección
Junta Inspeção



Salida escape
Saída escapamento



Admisión
Admissão



Escape
Escapamento



Bancada
Mancal



Bomba combustible
Bomba combustível



Junta Tapa Válvula Superior
Junta Tampa Válvula Superior



Bancada
Virabrequim



Bomba de agua
Bomba de água



Bomba de agua
Bomba de água



Junta Cártel
Junta Carter

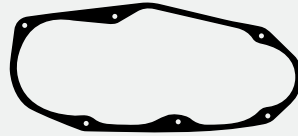

Sobre cárter
Sobre carter



Junta



Junta



Junta



Junta



Junta



Juego Retenes Guía de Válvulas
Jogo Retentor da Haste de Válvulas



Retén Bancada
Retentor Traseiro do Virabrequim



Retén Árbol de Leva
Retentor do Eixo Comando de Válvulas



Productos relacionados no incluidos en el juego. Los mismos pueden ser solicitados por separado.

Produtos relacionados não incluídos no jogo. Podem ser solicitados em separado.

Related products that were not included in the set but can be ordered separately.

Juego Completo de Reparación:

Jogo de Juntas do Motor / Full Set Gasket:

JR-350-15**Semi-Juego de Reparación:**

Semi-Jogo de Juntas / Semi-Set Gasket:

SJ-350**Juego de Descarbonización:**

Jogo de Juntas Superior / Head Set Gasket:

JD-350-15

JUNTA CULATA DE CILINDROS	TC-516-15	∅ 73.80mm	1.50mm	↑ ↓
	TC-516-MG	∅ 73.80mm	1.50mm	↑ ↓
Junta de cabeçote		∅	↑ ↓	↑ ↓
Cylinder Head gasket		∅	↑ ↓	↑ ↓

DESCRIPCIÓN / Descrição / Description

HONDA: Fit 2003/... - City 2004/...
Jazz 2005/...

MOTOR / Engine	CM ³	HP	∅ PISTON
L13A3/L13A5 8V	1339	82/88	73.00
I-DSI-TWIN SPARK	1339		73.00

ILLINOIS

HONDA

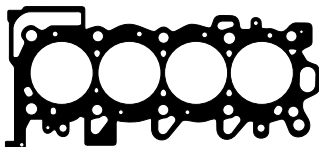
**JD-350-15**

TC-516-15 - 12251REAZ01
Junta Culata de Cilindros
Junta Cabeçote



JAE-264-A
Juego Admisión
Jogo Admissão

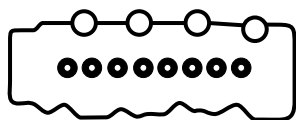

JVS-350-43 - 56033300
Junta Tapa Válvula Superior c/arandelas
Junta Tampa Válvula Superior c/arruelas



JAE-541-A - 13187200
Junta Admisión
Junta Admissão



JAE-543-E - 13187300
Junta Escape
Junta Escapamento

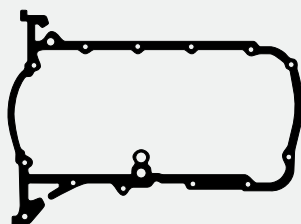

JC-372-43 - 14090600
Junta Carter
Junta Carter



2771300
Válvula EGR



1005000
Bomba aceite
Bomba óleo



2757600
Bomba de agua
Bomba de água



1010000
Válvula EGR

2757700 - Juego Arandelas Goma/Jogo Arruelas Borracha

Gráfico	Descripción/Descrição	Cant./Quant.
○	O'ring 46,69x2,62mm	1
○	O'ring 26,57x3,53mm	2
○	O'ring 25x2,62mm	1
○	O'ring 18,72x2,62mm	1
○	O'ring 15,64x2,62mm	1
○	O'ring 10,82x1,78mm	1
○	O'ring 9x2mm	1

Productos relacionados no incluidos en el juego. Los mismos pueden ser solicitados por separado.

Produtos relacionados não incluídos no jogo. Podem ser solicitados em separado.

Related products that were not included in the set but can be ordered separately.

DESCRIPCIÓN / Descrição / Description

HONDA: Civic 1987/... - CRX 1988/...
(06110P03000)

MOTOR / Engine	CM ³	HP	Ø PISTON
D13B1/2	1343	75	75.00
D15B1/2/3/4/7/8	1493	70/84/94/98	75.00
D16A1/6/7/9	1590	107/115	75.00
D16Z1/2	1590	106/110	75.00

Juego Completo de Reparación:

Jogo de Juntas do Motor / Full Set Gasket:

JR-687-07

Semi-Juego de Reparación:

Semi-Jogo de Juntas / Semi-Set Gasket:

Juego de Descarbonización:

Jogo de Juntas Superior / Head Set Gasket:

JUNTA CULATA DE CILINDROS	TC-838-07	Ø 76.00mm	1.40mm	RECARBONIZADO
Junta de cabeçote				
Cylinder Head gasket				

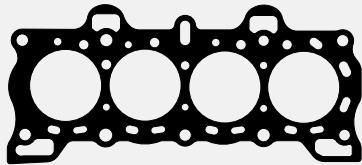

TC-838-07
Junta Culata de Cilindros
Junta Cabeçote



Junta



Junta Admisión
Junta Admissão



Junta Escape
Junta Escapamento

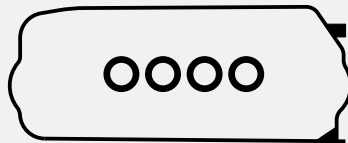

Junta Tapa de Válvula
Junta Tampa de Valvula



Junta



Junta



Junta

Productos relacionados no incluidos en el juego. Los mismos pueden ser solicitados por separado.

Produtos relacionados não incluídos no jogo. Podem ser solicitados em separado.

Related products that were not included in the set but can be ordered separately.

Juego Completo de Reparación:

Jogo de Juntas do Motor / Full Set Gasket:

JR-814-11**R**

DESCRIPCIÓN / Descrição / Description

HONDA: Civic 2015/...

MOTOR / Engine

CM³

HP

Ø PISTON

L15B8

1490

120

73.00

Juego de Descarbonización:

Jogo de Juntas Superior / Head Set Gasket:

JUNTA CULATA DE CILINDROS

TC-646-11

∅ ---mm

X ---mm

↑

↓

↑

↓

↑

↓

↑

↓

↑

↓

↑

↓

↑

↓

↑

↓

↑

↓

↑

↓

↑

↓

↑

↓

↑

↓

↑

Junta de cabeçote

Cylinder Head gasket

ILLINOIS.

HONDA

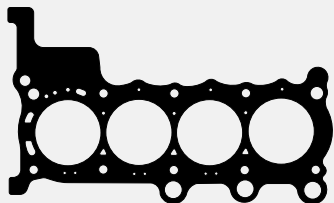
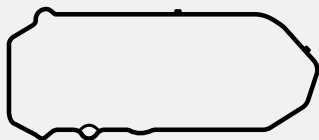
**TC-646-11**Junta Culata de Cilindros
Junta CabeçoteJuego Admisión
Jogo AdmissãoBomba de agua
Bomba de águaJunta Tapa Válvula Superior
Junta Tampa Válvula Superior

Junta



Junta



Junta



Junta



Junta



Junta



Junta

Juego Retenes Guía de Válvulas
Jogo Retentor da Haste de VálvulasRetén Distribución
Retentor Dianteiro do VirabrequimRetén Bancada
Retentor Traseiro do Virabrequim**R**

Productos relacionados no incluidos en el juego. Los mismos pueden ser solicitados por separado.

Produtos relacionados não incluídos no jogo. Podem ser solicitados em separado.

Related products that were not included in the set but can be ordered separately.

DESCRIPCIÓN / Descrição / Description

HONDA: City 2005/... - City ZX 2007/...
Jazz 2006/...

MOTOR / Engine	CM ³	HP	Ø PISTON
L15A VTEC 16V	1497	87/107	73.00

Juego Completo de Reparación:

Jogo de Juntas do Motor / Full Set Gasket:

JR-351-15

Semi-Juego de Reparación:

Semi-Jogo de Juntas / Semi-Set Gasket:

SJ-351

Juego de Descarbonización:

Jogo de Juntas Superior / Head Set Gasket:

JD-351-15

JUNTA CULATA DE CILINDROS	TC-416-15	Ø 73.80mm	1.50mm	↕
Junta de cabeçote	TC-416-MG	Ø 73.80mm	1.50mm	↕
Cylinder Head gasket				↕

MENÜ

JD-351-15

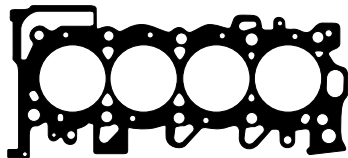

TC-416-15 - 12251REBZ01
Junta Culata de Cilindros
Junta Cabeçote



JAE-264-A
Juego Admisión
Jogo Admissão
17105PWA007

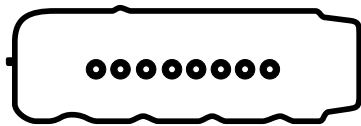

JVS-351-43
Junta Tapa Válvula Superior c/ arandelas
Junta Tampa Válvula Superior c/ arruelas



JAE-541-A - 13187200
Junta Admisión
Junta Admissão



JAE-543-E - 13187300
Junta Escape
Junta Escapamento

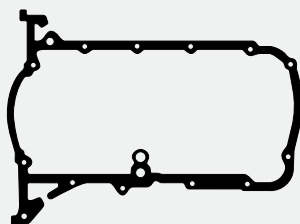

JC-372-43 - 14090600
Junta Cáster
Junta Carter



2771300
Valvula EGR



1005000
Bomba aceite
Bomba óleo



2757600
Bomba de agua
Bomba de água



1010000
Valvula EGR

2757700 - Juego Arandelas Goma/Jogo Arruelas Borracha

Gráfico	Descripción/Descrição	Cant./Quant.
○	O'ring 46,69x2,62mm	1
○	O'ring 26,57x3,53mm	2
○	O'ring 25x2,62mm	1
○	O'ring 18,72x2,62mm	1
○	O'ring 15,64x2,62mm	1
○	O'ring 10,82x1,78mm	1
○	O'ring 9x2mm	1

Productos relacionados no incluidos en el juego. Los mismos pueden ser solicitados por separado.

Produtos relacionados não incluídos no jogo. Podem ser solicitados em separado.

Related products that were not included in the set but can be ordered separately.

Juego Completo de Reparación:

Jogo de Juntas do Motor / Full Set Gasket:

JR-740-07

DESCRIPCIÓN / Descrição / Description

HONDA: Civic VI VTEC 2005/...
Civic VII VTEC 2005/09
Accord Tourer 2009/... - CRV 2009/...

ILLINOIS

HONDA

Semi-Juego de Reparación:

Semi-Jogo de Juntas / Semi-Set Gasket:

Juego de Descarbonización:

Jogo de Juntas Superior / Head Set Gasket:

JUNTA CULATA DE CILINDROS	TC-349-07	∅ 82.00mm	1.50mm	↑ ↓
	TC-349-11	∅ 82.00mm	1.40mm	↑ ↓
Junta de cabeçote				↑ ↓
Cylinder Head gasket				↑ ↓

MOTOR / Engine	CM ³	HP	∅ PISTON
R16A1/2 16V	1586	114	76.00
R18A1/2 16V	1798	140	81.00
R20A1/3 16V	1998	150/156	81.00

**TC-349-07**
12251R60U01/RNA002/A02
Junta Culata de Cilindros
Junta CabeçoteJunta Escape
Junta Escapamento

Junta

Junta Tapa de Válvula Superior
Junta Tampa Válvula SuperiorJuego Admisión
Jogo Admissão

Junta

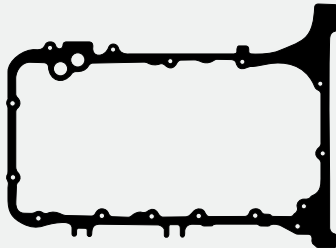
Junta Carter
Junta Carter

Junta



Junta

Juego Retenes Guía de Válvulas
Jogo Retentor haste de VálvulasRetén Bancada
Retentor Traseiro do Virabrequim
80,00 x 98,00 x 10,00Retén Distribución
Retentor Dianteiro do Virabrequim
43,00 x 58,00 x 7,00

Productos relacionados no incluidos en el juego. Los mismos pueden ser solicitados por separado.

Produtos relacionados não incluídos no jogo. Podem ser solicitados em separado.

Related products that were not included in the set but can be ordered separately.

DESCRIPCIÓN / Descrição / Description

HONDA: Civic Vtec 16V - Civic del Sol Vtec 16V
CRX Vtec 16V - Civic Coupe Vtec 16V

MOTOR / Engine	CM ³	HP	Ø PISTON
D16Z 6/7/9	1590	125	75.00

Juego Completo de Reparación:

Jogo de Juntas do Motor / Full Set Gasket:

JR-460-07



Semi-Juego de Reparación:

Semi-Jogo de Juntas / Semi-Set Gasket:

Juego de Descarbonización:

Jogo de Juntas Superior / Head Set Gasket:

JUNTA CULATA DE CILINDROS	TC-360-07	Ø 76.00mm	▶▶	◀◀
Junta de cabeçote			▶▶	◀◀
Cylinder Head gasket			▶▶	◀◀

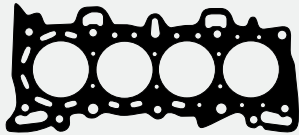

TC-360-07 -
12251PM5S02P08004/P2J004
Junta Culata de Cilindros
Junta Cabeçote



Junta



19222P01004
Bomba de agua
Bomba de água

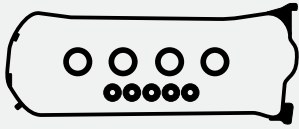

12341P10A0
Junta Tapa Válvula Superior c/arruelas
Junta Tampa Válvula Superior c/arruelas



17105P00T03
Junta Admisión
Junta Admissão



Junta Escape
Junta Escapamento

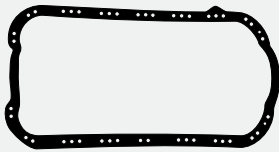

11251P01004
Junta Cáster
Junta Cáster



Junta

Productos relacionados no incluidos en el juego. Los mismos pueden ser solicitados por separado.

Produtos relacionados não incluídos no jogo. Podem ser solicitados em separado.

Related products that were not included in the set but can be ordered separately.

Juego Completo de Reparación:

Jogo de Juntas do Motor / Full Set Gasket:

JR-739-07

DESCRIPCIÓN / Descrição / Description

HONDA: Civic VTI Vtec 1991/00 - Civic SI Vtec 1999/00 - CRX VT Vtec 1992/00

MOTOR / Engine

CM³

HP

Ø PISTON

B16A1/2/3 16V

1595

160

81.00

Semi-Juego de Reparación:

Semi-Jogo de Juntas / Semi-Set Gasket:

Juego de Descarbonización:

Jogo de Juntas Superior / Head Set Gasket:

JUNTA CULATA DE CILINDROS	TC-938-07	Ø 81.50mm	1.80mm	1.30mm	1.30mm
Junta de cabeçote	TC-938-11	Ø 81.50mm	1.80mm	1.30mm	1.30mm
Cylinder Head gasket					

ILLINOIS

HONDA

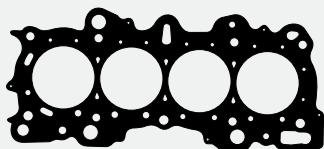
**TC-938-07** - 12251PR3004/P30004/014
Junta Culata de Cilindros
Junta Cabeçote

Junta

Bomba de Agua
Bomba de águaJunta Admisión
Junta AdmissãoJunta Escape
Junta Escapamento

Junta

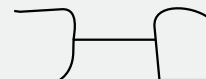
Junta Tapa de Válvula Superior
Junta Tampa Válvula SuperiorBrida
Flange

Junta

Junta Cártel
Junta CarterJuego Retenes Guía de Válvulas
Jogo Retentor da Haste de VálvulasRetén Bancada
Retentor Traseiro do Virabrequim
80,00 x 100,00 x 10,00Retén Árbol de Leva
Retentor do Eixo Comando de Válvulas
29,00 x 45,00 x 8,00

Productos relacionados no incluidos en el juego. Los mismos pueden ser solicitados por separado.

Produtos relacionados não incluídos no jogo. Podem ser solicitados em separado.

Related products that were not included in the set but can be ordered separately.

DESCRIPCIÓN / Descrição / Description

HONDA: Civic VII 2005/12 - CRV III 2007/...

MOTOR / Engine	CM ³	HP	Ø PISTON
R16A1 16V	1595	114	81.00
R18A1/2 16V	1799	132/140	81.00
R20A1/2/3 16V	1997	150/155	81.00

Juego Completo de Reparación:

Jogo de Juntas do Motor / Full Set Gasket:

JR-815-11



Semi-Juego de Reparación:

Semi-Jogo de Juntas / Semi-Set Gasket:

Juego de Descarbonización:

Jogo de Juntas Superior / Head Set Gasket:

JUNTA CULATA DE CILINDROS	TC-349-07	Ø 82.00mm	1.50mm	1.50mm
Junta de cabeçote	TC-349-11	Ø 82.00mm	1.40mm	1.40mm
Cylinder Head gasket				

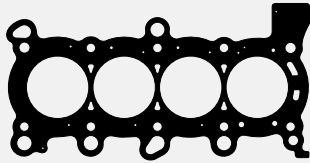

TC-349-11 - 12251RNA002/AA01/AA02/2251R60U01
Junta Culata de Cilindros
Junta Cabeçote



Juego Admisión
Jogo Admissão



Junta



Junta Escape
Junta Escapamento



Salida de Escape
Saída Escapamento



Junta



Junta Tapa Válvula Superior
Junta Tampa Válvula Superior



Junta



Retén Bancada
Retentor Traseiro do Virabrequim



Retén Distribución
Retentor Dianteiro do Virabrequim



Juego Retenes Guía de Válvulas
Jogo Retentor da Haste de Válvulas



Productos relacionados no incluidos en el juego. Los mismos pueden ser solicitados por separado.

Produtos relacionados não incluídos no jogo. Podem ser solicitados em separado.

Related products that were not included in the set but can be ordered separately.

Juego Completo de Reparación:

Jogo de Juntas do Motor / Full Set Gasket:

JR-738-11

DESCRIPCIÓN / Descrição / Description

HONDA: Civic 1997/05 - Civic Coupe 2001/...
Stream 2001/... (06110PLC010)

MOTOR / Engine

CM³

HP

Ø PISTON

D17A2/9

1668

116/120

75.00

D17Z1

1668

118

75.00

Semi-Juego de Reparación:

Semi-Jogo de Juntas / Semi-Set Gasket:

Juego de Descarbonización:

Jogo de Juntas Superior / Head Set Gasket:

JUNTA CULATA DE CILINDROS	TC-937-11	Ø 76.00mm	0.80mm	↑ ↓
	TC-937-07	Ø 75.50mm	1.75mm	↑ ↓
Junta de cabeçote		Ø		↑ ↓
Cylinder Head gasket		Ø		↑ ↓

ILLINOIS

HONDA

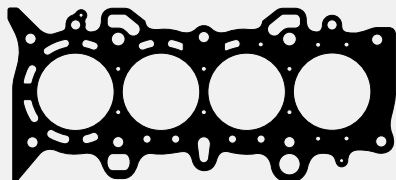
TC-937 - 12251PLC003/4
Junta Culata de Cilindros
Junta CabeçoteJunta Escape
Junta Escapamento

Junta

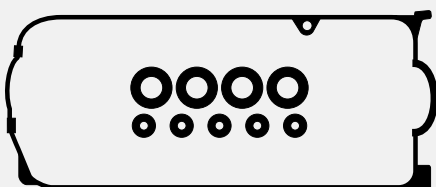
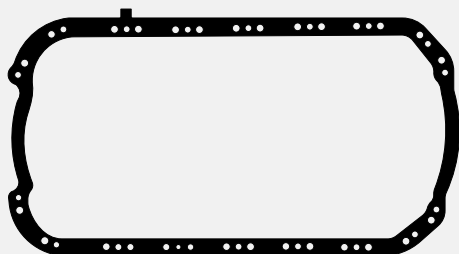
Junta Tapa de Válvula Superior
Junta Tampa de Válvula SuperiorJunta Admisión
Junta AdmissãoBomba de agua
Bomba de águaJunta Carter
Junta Cárter

Junta

Juego Retenes Guía de Válvulas
Jogo Retentor da Haste de VálvulasRetén Bancada
Retentor Traseiro do VirabrequimRetén Árbol de Leva
Retentor do Eixo Comando de VálvulasRetén Distribución
Retentor Dianteiro do Virabrequim

Productos relacionados no incluidos en el juego. Los mismos pueden ser solicitados por separado.

Produtos relacionados não incluídos no jogo. Podem ser solicitados em separado.

Related products that were not included in the set but can be ordered separately.

DESCRIPCIÓN / Descrição / Description

HONDA: Accord - Prelude 1979/83

MOTOR / Engine	CM ³	HP	Ø PISTON
EK1	1751	69	77.00

Juego Completo de Reparación:

Jogo de Juntas do Motor / Full Set Gasket:

JR-685-07



Semi-Juego de Reparación:

Semi-Jogo de Juntas / Semi-Set Gasket:

Juego de Descarbonización:

Jogo de Juntas Superior / Head Set Gasket:

JUNTA CULATA DE CILINDROS	TC-348-07	Ø 78.50mm	1.70mm	↑ ↓
Junta de cabeçote		Ø	↑ ↓	↑ ↓
Cylinder Head gasket		Ø	↑ ↓	↑ ↓

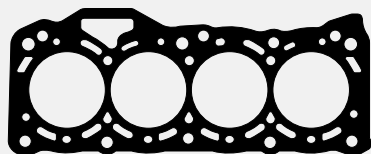

TC-348-07
Junta Culata de Cilindros
Junta Cabeçote



Junta



Bomba de agua
Bomba d'água



Junta Escape
Junta Escapamento



Junta



Junta

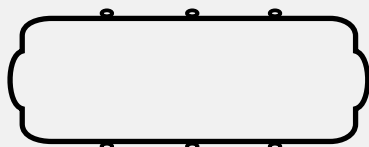

Junta Tapa Válvula Superior
Junta Tampa Válvula Superior



Junta



Junta



Junta Cártar
Junta Carter



Retén Bancada
Ret. Traseiro do Virabrequim
74,00 x 98,00 x 12,00



Juego Retenes Guía de Válvulas
Jogo Retedor da Haste de Válvulas



Retén Distribución
Ret. Dianteiro do Virabrequim
35,00 x 50,00 x 8,00



Retén Árbol de Leva
Ret. do Eixo Comando de Válvulas
27,00 x 43,00 x 9,00

Productos relacionados no incluidos en el juego. Los mismos pueden ser solicitados por separado.

Produtos relacionados não incluídos no jogo. Podem ser solicitados em separado.

Related products that were not included in the set but can be ordered separately.

Juego Completo de Reparación:

Jogo de Juntas do Motor / Full Set Gasket:

JR-688-11

DESCRIPCIÓN / Descrição / Description

HONDA: Accord 1989/98 - Prelude 1992/96
(06110PT5000/010)

MOTOR / Engine	CM ³	HP	Ø PISTON
F18A	1849	105	85.00

ILLINOIS

HONDA

Semi-Juego de Reparación:

Semi-Jogo de Juntas / Semi-Set Gasket:

Juego de Descarbonización:

Jogo de Juntas Superior / Head Set Gasket:

JUNTA CULATA DE CILINDROS	TC-921-07	Ø 86.00mm	1.80mm	1.20mm	1.20mm	1.20mm	1.20mm	1.20mm	1.20mm
Junta de cabeçote	TC-921-11	Ø 86.00mm	1.80mm	1.20mm	1.20mm	1.20mm	1.20mm	1.20mm	1.20mm
Cylinder Head gasket									

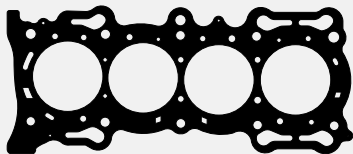
**TC-921 - 12251PT0J02/004/014**
Junta Culata de Cilindros
Junta Cabeçote

Junta



Junta

Junta Admisión
Junta AdmissãoJunta Escape
Junta Escapamento

Junta

Junta Tapa de Válvula Superior
Junta Tampa de Válvula Superior

Junta



Junta

Junta Carter
Junta Cârtter

Junta



Junta



Junta



Junta

Retén Bancada
Retentor Traseiro do
VirabrequimRetén Árbol de Leva
Retentor do Eixo Comando
de VálvulasJuego Retenes Guía de Válvulas
Jogo Retentor da Haste de VálvulasRetén Distribución
Retentor Dianteiro do
VirabrequimRetén Auxiliar
Retentor Auxiliar

Productos relacionados no incluidos en el juego. Los mismos pueden ser solicitados por separado.

Produtos relacionados não incluídos no jogo. Podem ser solicitados em separado.

Related products that were not included in the set but can be ordered separately.

DESCRIPCIÓN / Descrição / Description			
HONDA: Prelude CRV 1997/00 (06110P8R004)			
MOTOR / Engine	CM ³	HP	Ø PISTON
B20B	1972	125	84.00

Juego Completo de Reparación: Jogo de Juntas do Motor / Full Set Gasket:	JR-686-11	R		
Semi-Juego de Reparación: Semi-Jogo de Juntas / Semi-Set Gasket:				
Juego de Descarbonización: Jogo de Juntas Superior / Head Set Gasket:				
JUNTA CULATA DE CILINDROS	TC-798-11	Ø 85.00mm	1.20mm	↑ ↓
Junta de cabeçote				↑ ↓
Cylinder Head gasket				↑ ↓

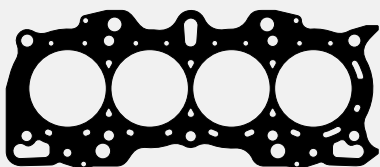

TC-798-11 - 12251P8R004/12251P3F005
Junta Culata de Cilindros
Junta Cabeçote



Bomba de agua
Bomba d'água



Junta Admisión
Junta Admissão



Junta



Junta Escape
Junta Escapamento



Junta Carter
Junta Cártter

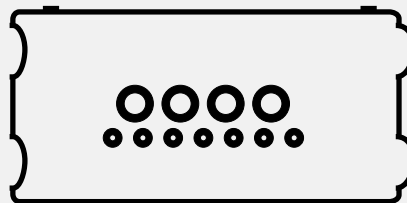

Junta Tapa de Válvula
Junta Tampa de Valvula



Retén Bancada
Retentor Traseiro do Virabrequim



Juego Retenes Guía de Válvulas
Jogo Retentor da Haste de Válvulas



Retén Distribución
Retentor Dianteiro do Virabrequim



Retén Árbol de Leva
Retentor do Eixo Comando de Válvulas

Productos relacionados no incluidos en el juego. Los mismos pueden ser solicitados por separado.

Produtos relacionados não incluídos no jogo. Podem ser solicitados em separado.

Related products that were not included in the set but can be ordered separately.

Juego Completo de Reparación:

Jogo de Juntas do Motor / Full Set Gasket:

JR-816-11

DESCRIPCIÓN / Descrição / Description

HYUNDAI: i10 2012/... EON 2013/...**KIA:** Picanto 2011/...**Semi-Juego de Reparación:**

Semi-Jogo de Juntas / Semi-Set Gasket:

Juego de Descarbonización:

Jogo de Juntas Superior / Head Set Gasket:

JUNTA CULATA DE CILINDROS	TC-653-11	∅ 72.00mm	0.50mm	↑ ↓
Junta de cabeçote		∅		↑ ↓
Cylinder Head gasket		∅		↑ ↓

MOTOR / Engine	CM ³	HP	∅ PISTON
G3LA	998	67/69	71.00

ILLINOIS.

HYUNDAI

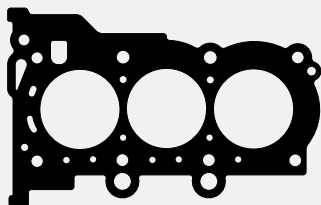

TC-653-11 - 2231104020
Junta Culata de Cilindros
Junta Cabeçote



Juego Admisión
Jogo Admissão



Arandela goma
Arruela borracha

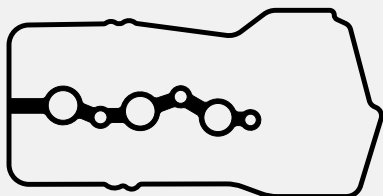

Junta Tapa Válvula Superior
Junta Tampa Válvula Superior



Junta Escape
Junta Escapamento



Junta



Juego Retenes Guía de Válvulas
Jogo Retentor da Haste de Válvulas



Retén Distribución
Retentor Dianteiro do Virabrequim



Retén Bancada
Retentor Traseiro do Virabrequim



Productos relacionados no incluidos en el juego. Los mismos pueden ser solicitados por separado.

Produtos relacionados não incluídos no jogo. Podem ser solicitados em separado.

Related products that were not included in the set but can be ordered separately.

DESCRIPCIÓN / Descrição / Description

HYUNDAI: i20 - i30
KIA: Rio

MOTOR / Engine	CM ³	HP	Ø PISTON
G3LC	998	101	71.00

Juego Completo de Reparación:
Jogo de Juntas do Motor / Full Set Gasket:

JR-817-11



Semi-Juego de Reparación:
Semi-Jogo de Juntas / Semi-Set Gasket:

Juego de Descarbonización:
Jogo de Juntas Superior / Head Set Gasket:

JUNTA CULATA DE CILINDROS	TC-651-11	Ø 72.50mm	0.60mm	↑ ↓
Junta de cabeçote		Ø		↑ ↓
Cylinder Head gasket		Ø		↑ ↓

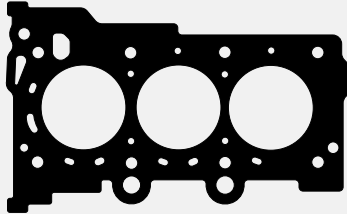

TC-651-11
Junta Culata de Cilindros
Junta Cabeçote



Juego Admisión
Jogo Admissão



Arandela goma
Arruela borracha

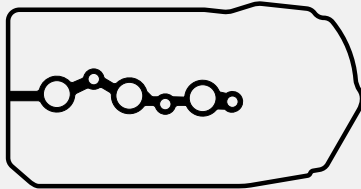

Junta Tapa Válvula Superior
Junta Tampa Válvula Superior



Salida Escape
Saída Escapamento



Junta



Juego Retenes Guía de Válvulas
Jogo Retentor da Haste de Válvulas



R
Retén Bancada
Retentor Traseiro do
Virabrequim

Productos relacionados no incluidos en el juego. Los mismos pueden ser solicitados por separado.

Produtos relacionados não incluídos no jogo. Podem ser solicitados em separado.

Related products that were not included in the set but can be ordered separately.

Juego Completo de Reparación:

Jogo de Juntas do Motor / Full Set Gasket:

JR-568-15**Semi-Juego de Reparación:**

Semi-Jogo de Juntas / Semi-Set Gasket:

SJ-568**Juego de Descarbonización:**

Jogo de Juntas Superior / Head Set Gasket:

JD-568-15

JUNTA CULATA DE CILINDROS	TC-820-15	∅ 72.70mm	1.50mm	↑ ↓
Junta de cabeçote		∅	↑ ↓	↑ ↓
Cylinder Head gasket		∅	↑ ↓	↑ ↓

DESCRIPCIÓN / Descrição / Description

HYUNDAI: HB20 2012/...
KIA: Picanto 2011/...

MOTOR / Engine	CM ³	HP	∅ PISTON
Kappa 12V	998	80/98	71.00

ILLINOIS

HYUNDAI

JD-568-15

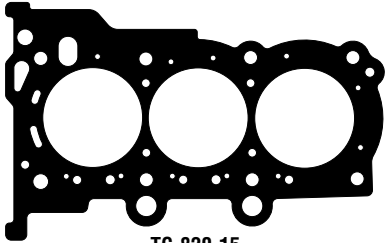

TC-820-15
 Junta Culata de Cilindros
 Junta Cabeçote



JAE-634-A
 Juego Admisión
 Jogo Admissão

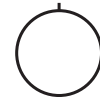

2778300
 Cuerpo mariposa
 Corpo borboleta

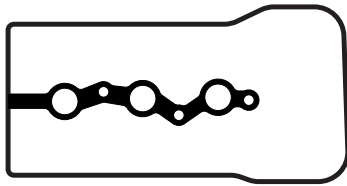

JVS-415-43
 Junta Tapa Válvula Superior
 Junta Tampa Válvula Superior



JAE-635-E
 Junta Escape
 Junta Escapamento



2778300
 Juego Retenes Guía de Válvulas
 Jogo Retentor da Haste de Válvulas



2778200
 Bomba de agua
 Bomba de água



Retén Bancada
 Retentor Traseiro do Virabrequim
 72,00 x 98,00 x 8,00



Retén Distribución
 Ret. Dianteiro do Virabrequim
 34,00 x 48,00 x 7,00

Productos relacionados no incluidos en el juego. Los mismos pueden ser solicitados por separado.

Produtos relacionados não incluídos no jogo. Podem ser solicitados em separado.

Related products that were not included in the set but can be ordered separately.

DESCRIPCIÓN / Descrição / Description

HYUNDAI: Atos 1998/03 - Santro 1997/...
(2091002B00)

MOTOR / Engine	CM ³	HP	Ø PISTON
G4HC	999	54	66.00

Juego Completo de Reparación:

Jogo de Juntas do Motor / Full Set Gasket:

JR-684-07

R

Semi-Juego de Reparación:

Semi-Jogo de Juntas / Semi-Set Gasket:

Juego de Descarbonización:

Jogo de Juntas Superior / Head Set Gasket:

JUNTA CULATA DE CILINDROS	TC-872-15	∅ 67.50mm	1.60mm	∅
Junta de cabeçote				
Cylinder Head gasket				

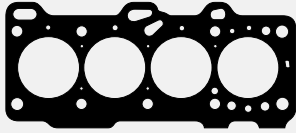

TC-782-15 - 2231102700
Junta Culata de Cilindros
Junta Cabeçote



Salida Escape
Saída Escapamento



Junta



Junta Admisión
Junta Admissão



Junta Escape
Junta Escapamento



Bomba de agua
Bomba d'água

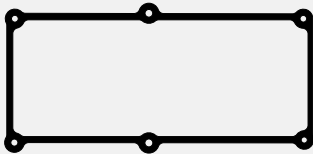

Junta Tapa de Válvula
Junta Tampa de Válvula



Junta



Junta

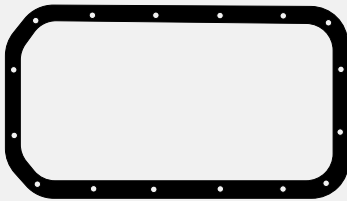

Junta Carter
Junta Cártier



Distribución
Distribuição



Distribución
Distribuição



Junta



Junta



Junta



Junta



Junta



Junta



Retén Bancada
Retentor Traseiro do
Virabrequim



Retén Distribución
Retentor Dianteiro do
Virabrequim



Retén Árbol de Leva
Retentor do Eixo Comando
de Válvulas



Juego Retenes Guía de Válvulas
Jogo Retentor da Haste
de Válvulas

R

Productos relacionados no incluidos en el juego. Los mismos pueden ser solicitados por separado.

Produtos relacionados não incluídos no jogo. Podem ser solicitados em separado.

Related products that were not included in the set but can be ordered separately.

Juego Completo de Reparación:

Jogo de Juntas do Motor / Full Set Gasket:

JR-818-11**R**

DESCRIPCIÓN / Descrição / Description

HYUNDAI: Atos Prime 2005/08 - Getz 2005/08
Santro 2005/08 - Picanto 2004/12**Semi-Juego de Reparación:**

Semi-Jogo de Juntas / Semi-Set Gasket:

Juego de Descarbonización:

Jogo de Juntas Superior / Head Set Gasket:

JUNTA CULATA DE CILINDROS	TC-918-07	∅ 68.00mm	0.65mm	↑ ↓
Junta de cabeçote				↑ ↓
Cylinder Head gasket				↑ ↓

MOTOR / Engine	CM ³	HP	∅ PISTON
G4HG	1086	61/65	67.00

ILLINOIS.

HYUNDAI

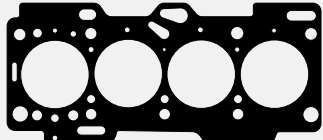

TC-918-07 - 2237402700
Junta Culata de Cilindros
Junta Cabeçote



Distribución
Distribuição



Distribución
Distribuição



Junta Escape
Junta Escapamento



Junta Admisión
Junta Admissão



Colector Admisión
Coletor Admissão

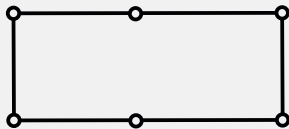

Junta Tapa Válvula Superior
Junta Tampa Válvula Superior



Bomba de agua
Bomba de água



Junta



Junta



Retén Bancada
Retentor Traseiro do Virabrequim



Juego Retenes Guía de Válvulas
Jogo Retentor da Haste de Válvulas



Retén Distribución
Retentor Dianteiro do Virabrequim



Retén Árbol de Leva
Retentor do Eixo Comando de Válvulas

Productos relacionados no incluidos en el juego. Los mismos pueden ser solicitados por separado.

Produtos relacionados não incluídos no jogo. Podem ser solicitados em separado.

Related products that were not included in the set but can be ordered separately.

DESCRIPCIÓN / Descrição / Description

HYUNDAI: HB20 2006/... - I20 2009/...
I30 2010/... - Elantra 2006/... - Veloster 2013/...
KIA: Soul 2009/... - Cerato 2010/...

MOTOR / Engine	CM ³	HP	Ø PISTON
G4FC Gamma	1591	126	77.00

Juego Completo de Reparación:

Jogo de Juntas do Motor / Full Set Gasket:

JR-741-07



Semi-Juego de Reparación:

Semi-Jogo de Juntas / Semi-Set Gasket:

Juego de Descarbonización:

Jogo de Juntas Superior / Head Set Gasket:

JUNTA CULATA DE CILINDROS	TC-945-07	Ø 78.50mm	1.60mm	↑ ↓
Junta de cabeçote				↑ ↓
Cylinder Head gasket				↑ ↓



TC-945-07 - 223112B002/3
Junta Culata de Cilindros
Junta Cabeçote

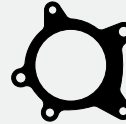

Junta



Junta



JAE-606-E - 285212B001/400
Junta Escape
Junta Escapamento

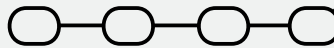

JAE-605-A - 284112B000
Junta Admisión
Junta Admissão



2774200
Cuerpo mariposa
Corpo borboleta

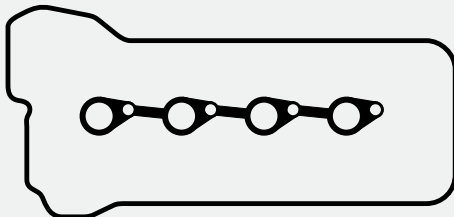

JVS-401-43 - 224412B000/2
Junta Tapa Válvula Superior
Junta Tampa Válvula Superior



Junta



Junta



Junta



RT-993Vit
Juego Retenes Guía de Válvulas
Jogo Retentor da Haste de Válvulas



RT-2981Sil
Retén Bancada
Retentor Traseiro do Virabrequim
26,00 x 37,50 x 6,00



RT-2982Sil
Retén Auxiliar
Retentor Auxiliar
76,00 x 108,00 x 8,00



Productos relacionados no incluidos en el juego. Los mismos pueden ser solicitados por separado.

Produtos relacionados não incluídos no jogo. Podem ser solicitados em separado.

Related products that were not included in the set but can be ordered separately.

Juego Completo de Reparación:

Jogo de Juntas do Motor / Full Set Gasket:

JR-683-07**Semi-Juego de Reparación:**

Semi-Jogo de Juntas / Semi-Set Gasket:

Juego de Descarbonización:

Jogo de Juntas Superior / Head Set Gasket:

JUNTA CULATA DE CILINDROS	TC-145-06	∅ 83.80mm	1.40mm	↑ ↓
Junta de cabeçote				↑ ↓
Cylinder Head gasket				↑ ↓

DESCRIPCIÓN / Descrição / Description

HYUNDAI: Elantra 1990/95 - Lantra 1990/95
(2091033A10)

MOTOR / Engine	CM ³	HP	∅ PISTON
G4CR	1596	106	82.30
G4CN	1836	127	81.50

ILLINOIS

HYUNDAI

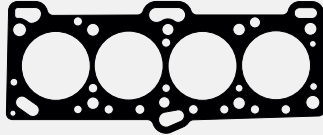

TC-145-06
Junta Culata de Cilindros
Junta Cabeçote



Junta



Distribución
Distribuição



Junta Admisión
Junta Admissão



Junta Escape
Junta Escapamento



Junta

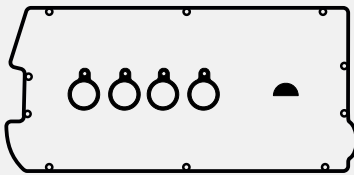

Junta Carter
Junta Câter



Distribución
Distribuição



Junta

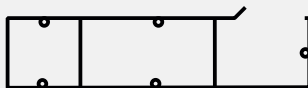

Junta



Arbol de leva
Eixo Comando de Válvulas

Productos relacionados no incluidos en el juego. Los mismos pueden ser solicitados por separado.

Produtos relacionados não incluídos no jogo. Podem ser solicitados em separado.

Related products that were not included in the set but can be ordered separately.

DESCRIPCIÓN / Descrição / Description **DIESEL**

HYUNDAI: Tucson HDI Elantra Santa Fe 2000/06
(2091027A00)

MOTOR / Engine	CM ³	HP	Ø PISTON
D4EA	1991	113	83.00

Juego Completo de Reparación:

Jogo de Juntas do Motor / Full Set Gasket:

JR-682-11

R

Semi-Juego de Reparación:

Semi-Jogo de Juntas / Semi-Set Gasket:

Juego de Descarbonización:

Jogo de Juntas Superior / Head Set Gasket:

JUNTA CULATA DE CILINDROS	TC-676-11	Ø 84.00mm	1.10mm	INCLUIDO
Junta de cabeçote				
Cylinder Head gasket				

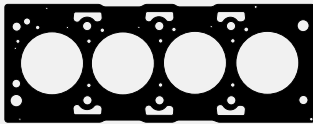

TC-676-11 - 2231127401
Junta Culata de Cilindros
Junta Cabeçote



Bomba de agua
Bomba de água



Junta Turbo
Junta Turbo



Junta Admisión
Junta Admissão



Junta Escape
Junta Escapamento



Junta Turbo
Junta Turbo

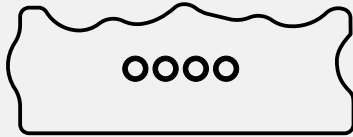

Junta Tapa de Válvula
Junta Tampa de Valvula



Junta



Junta



Junta



Junta



Junta



Junta



Junta



Junta



Juego Retenes Guía de Válvulas
Jogo Retentor da Haste de Válvulas



Retén Bancada
Retentor Traseiro do
Virabrequim



Retén Árbol de Leva
Retentor do Eixo Comando
de Válvulas



Retén Distribución
Retentor Dianteiro do
Virabrequim

R

Productos relacionados no incluidos en el juego. Los mismos pueden ser solicitados por separado.

Produtos relacionados não incluídos no jogo. Podem ser solicitados em separado.

Related products that were not included in the set but can be ordered separately.

Juego Completo de Reparación:

Jogo de Juntas do Motor / Full Set Gasket:

JR-820-11

DESCRIPCIÓN / Descrição / Description

HYUNDAI: Sonata 2007/...**KIA:** Rondo 2006/... - Magentis 2005/...**Semi-Juego de Reparación:**

Semi-Jogo de Juntas / Semi-Set Gasket:

Juego de Descarbonización:

Jogo de Juntas Superior / Head Set Gasket:

JUNTA CULATA DE CILINDROS	TC-654-11	∅ 87.50mm	0.60mm	↑ ↓
Junta de cabeçote				↑ ↓
Cylinder Head gasket				↑ ↓

MOTOR / Engine	CM ³	HP	∅ PISTON
G4KA	1998	100/106	86.00

ILLINOIS.

HYUNDAI

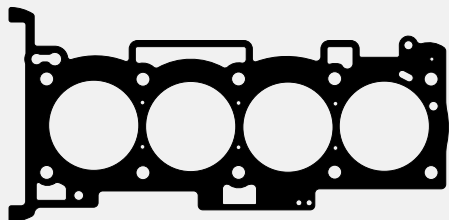

TC-654-11 - 223112B012/2231125013
Junta Culata de Cilindros
Junta Cabeçote



Bomba de agua
Bomba d'água



Junta

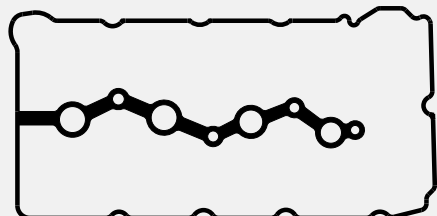

Junta Tapa Válvula Superior
Junta Tampa Válvula Superior



Junta



Junta



Junta Escape
Junta Escapamento



Juego Admisión
Jogo Admissão



Retén Bancada
Retentor Traseiro do Virabrequim



Retén Distribución
Retentor Dianteiro do Virabrequim



Juego Retenes Guía de Válvulas
Jogo Retentor da Haste de Válvulas



Productos relacionados no incluidos en el juego. Los mismos pueden ser solicitados por separado.

Produtos relacionados não incluídos no jogo. Podem ser solicitados em separado.

Related products that were not included in the set but can be ordered separately.

DESCRIPCIÓN / Descrição / Description

HYUNDAI: Santa Fe - iX35 - Tucson 2009/...
 Sonata 2007/...
KIA: Sorento - Rondo 2009/...
 Sportage 2011/...

MOTOR / Engine	CM ³	HP	Ø PISTON
G4KE	2359	177	88.00

Juego Completo de Reparación:

Jogo de Juntas do Motor / Full Set Gasket:

JR-821-11



Semi-Juego de Reparación:

Semi-Jogo de Juntas / Semi-Set Gasket:

Juego de Descarbonización:

Jogo de Juntas Superior / Head Set Gasket:

JUNTA CULATA DE CILINDROS	TC-656-11	Ø 89.50mm	0.60mm	↑ ↓
Junta de cabeçote		Ø		↑ ↓
Cylinder Head gasket		Ø		↑ ↓



TC-656-11 - 2231125212
 Junta Culata de Cilindros
 Junta Cabeçote



Bomba de agua
 Bomba d'água



Junta



Junta



Junta

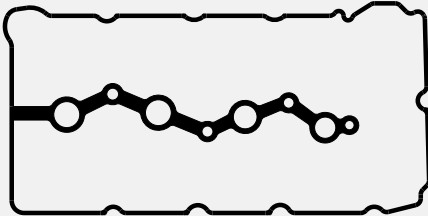

Junta Tapa Válvula Superior
 Junta Tampa Válvula Superior



Junta Escape
 Junta Escapamento



Juego Admisión
 Jogo Admissão



Retén Bancada
 Retentor Traseiro do Virabrequim



Retén Distribución
 Retentor Dianteiro do Virabrequim



Juego Retenes Guía de Válvulas
 Jogo Retentor da Haste de Válvulas



Productos relacionados no incluidos en el juego. Los mismos pueden ser solicitados por separado.

Produtos relacionados não incluídos no jogo. Podem ser solicitados em separado.

Related products that were not included in the set but can be ordered separately.

Juego Completo de Reparación:

Jogo de Juntas do Motor / Full Set Gasket:

Semi-Juego de Reparación:

Semi-Jogo de Juntas / Semi-Set Gasket:

Juego de Descarbonización:

Jogo de Juntas Superior / Head Set Gasket:

JUNTA CULATA DE CILINDROS Junta de cabeçote Cylinder Head gasket	TC-441 2M	Ø 92.20mm	1.40mm	de 0,55 a 0,62mm
	TC-441 3M	Ø 92.20mm	1.50mm	de 0,63 a 0,74mm
	TC-441 4M	Ø 92.20mm	1.60mm	de 0,75mm ...
	TC-441 5M	Ø 92.20mm	1.70mm	
	TC-441 6M	Ø 92.20mm	1.80mm	
	TC-441 7M	Ø 92.20mm	2.10mm	

DESCRIPCIÓN / Descrição / Description

DIESEL

HYUNDAI: H100 HR 8V 2008/11
MITSUBISHI: L200 1987/... L300 Canter T35
Pajero Montero 1986/...

MOTOR / Engine	CM ³	HP	Ø PISTON
D4B/H	2476	115/130	91.00
4D56T	2476	115	91.00

ILLINOIS

HYUNDAI

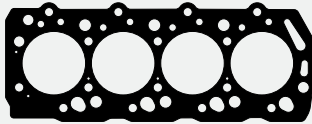

TC-441-20 2M TC-441-MG 2M
TC-441-20 3M TC-441-MG 3M
TC-441-20 4M TC-441-MG 4M
TC-441-20 5M TC-441-MG 5M
TC-441-20 6M TC-441-MG 6M
TC-441-20 7M TC-441-MG 7M

MD050545/088581/112531

Junta Culata de Cilindros/Junta Cabeçote

JD-488-ST



1102600

Tapa bomba de agua
Tampa bomba d'água



1111000

Filtro de aceite
Filtro de óleo



1133100

Termostato
Termostato



1135600

Chupador de aceite
Pescador óleo



1133200

Tapa termostato
Tampa termostato



RT-550Pol

Juego Retenes Guía de Válvulas
Jogo Retentor da Haste de Válvulas



RT-8130Vit

Retén Árbol de Levas
Ret. do Eixo Comando de Válvulas
Lx-R 35,00 x 50,00 x 8,00



JAE-597

Múltiple Admisión y Escape
Coletor Admissão e Escapamento



JVS-388-43

Junta Tapa de Válvula
Junta Tampa de Válvula

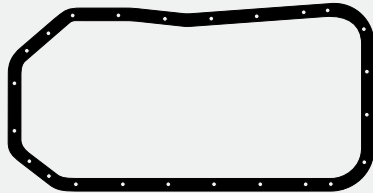

JC-400-34

Junta Cártel
Junta Carter



1130300

Porta retén trasero
Porta retentor trasero



1110300

Retorno aceite
Retorno óleo



1109600

Varilla aceite
Varela óleo



1122200

Base bomba de agua
Base bomba d'água



1103000

Base bomba de agua
Base bomba d'água



1102400

Tapa distribución
Tampa distribuição



2769800

Bomba de aceite
Bomba de óleo

2769000 - Juego Arandelas de Goma/Jogo Arruelas de Borracha

Gráfico	Descripción/Descrição	Cant./Quant.
	Medialuna Goma/Meia lua Borracha	1
	O'ring 25x3,5mm	1
	O'ring 25x2,5mm	1
	O'ring 8x1,78mm	2
	O'ring 4,5x1,78mm	1

2638100 - Juego Arandelas Metálicas/Jogo Arruelas Metálicas

Gráfico	Descripción/Descrição	Cant./Quant.
	Aran./Arruela 12x18x1mm Cobre	12
	Ar./Arruela 14x18x1,5mm Aluminio	1
	Aran./Arruela 18x23x1mm Aluminio	1
	Aran./Arruela 8x12x1mm Aluminio	4



RT-8311Pol

Retén Bancada
Retentor Trasero do Virabrequim
Lx-R 80,00 x 96,00 x 9,00



RT-8129Pol

Retén Distribución
Retentor Dianteiro do Virabrequim
Lx-R 44,20 x 60,00 x 7,00



RT-9501Pol

Retén Distribución
Retentor Dianteiro do Virabrequim
Lx-R-H 25,00 x 35,00 x 6,00



RT-9500Pol

Retén Distribución
Retentor Dianteiro do Virabrequim
Lx-R-H 17,00 x 28,00 x 7,00

Productos relacionados no incluidos en el juego. Los mismos pueden ser solicitados por separado.

Produtos relacionados não incluídos no jogo. Podem ser solicitados em separado.

Related products that were not included in the set but can be ordered separately.



BU-510

Bulones para
Culata de Cilindros

DESCRIPCIÓN / Descrição / Description

DIESEL

HYUNDAI: HR 2013/...
KIA: Sorento 2007/... - Bongo 2013/...

MOTOR / Engine	CM ³	HP	Ø PISTON
D4CB	2497	130	91.00

Juego Completo de Reparación:

Jogo de Juntas do Motor / Full Set Gasket:

JR-569-11

R

Semi-Juego de Reparación:

Semi-Jogo de Juntas / Semi-Set Gasket:

Juego de Descarbonización:

Jogo de Juntas Superior / Head Set Gasket:

JUNTA CULATA DE CILINDROS	TC-821-11	Ø 92.50mm	0.90mm	↑ ↓
Junta de cabeçote		Ø		↑ ↓
Cylinder Head gasket		Ø		↑ ↓

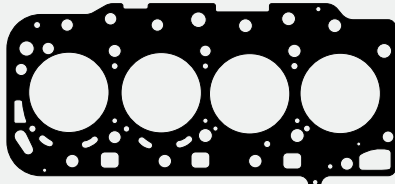

TC-821-11 - 223114A100
Junta Culata de Cilindros
Junta Cabeçote

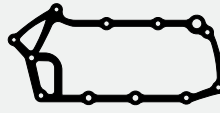

Junta



Bomba de agua
Bomba d'água



Juego Admisión
Jogo Admissão



Junta Escape
Junta Escapamento



Junta

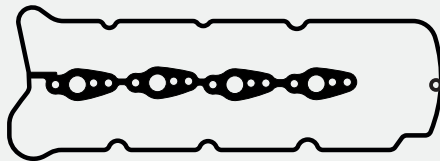

Junta Tapa Válvula Superior
Junta Tampa Válvula Superior



Junta



Junta Turbo



Juego Retenes Guía de Válvulas
Jogo Retentor da Haste de Válvulas



R
Retén Bancada
Retentor Traseiro do Virabrequim
91,00 x 114,00 x 9,00



Junta Turbo

Productos relacionados no incluidos en el juego. Los mismos pueden ser solicitados por separado.

Produtos relacionados não incluídos no jogo. Podem ser solicitados em separado.

Related products that were not included in the set but can be ordered separately.

Juego Completo de Reparación:

Jogo de Juntas do Motor / Full Set Gasket:

JR-723-11

DESCRIPCIÓN / Descrição / Description

DIESEL**ISUZU: Campo 1983/90 - Trooper 1988/...**
(5878102892/4572)

MOTOR / Engine	CM ³	HP	Ø PISTON
4JA1	2499	76	93.00

ILLINOIS

ISUZU

Juego de Descarbonización:

Jogo de Juntas Superior / Head Set Gasket:

JUNTA CULATA DE CILINDROS	TC-687-20 1M	∅ 94.00mm	1.50mm	↑ ↓
	TC-687-20 2M	∅ 94.00mm	1.60mm	↑ ↓
Junta de cabeçote	TC-687-20 3M	∅ 94.00mm	1.70mm	↑ ↓
Cylinder Head gasket				↑ ↓

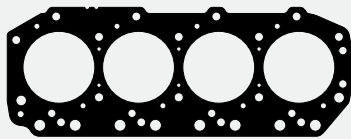

TC-687-20 1M - 8943323260/80/8944337330
TC-687-20 2M - 8943323260/80/8944337330
TC-687-20 3M - 8943323260/80/8944337330
 Junta Culata de Cilindros
 Junta Cabeçote



Junta



Junta

Junta Admisión
Junta AdmissãoJunta Escape
Junta EscapamentoBrida
FlangeJunta Tapa Válvula
Superior
Junta Tampa Válvula Superior

Junta

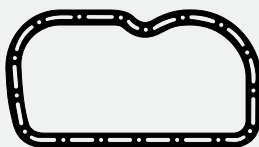
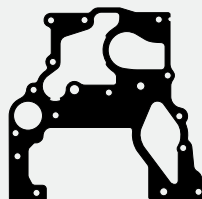
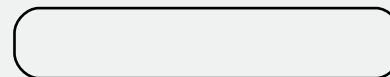
Bomba de agua
Bomba d'águaJunta Cárter
Junta CarterPlaca distribución
Placa distribuiçãoTapa distribución
Tampa distribuiçãoBancada
VirabrequimBancada
VirabrequimJuego Retenes Guía de Válvulas
Jogo Retentor da Haste de VálvulasRetén Bancada
Retentor Traseiro do Virabrequim
50,00 x 68,00 x 9,00Retén Distribución
Retentor Dianteiro do Virabrequim
95,00 x 118,00 x 10,00

Productos relacionados no incluidos en el juego. Los mismos pueden ser solicitados por separado.

Produtos relacionados não incluídos no jogo. Podem ser solicitados em separado.

Related products that were not included in the set but can be ordered separately.



BU-506
 Bulones para
 Culata de Cilindros
 Parafusos Cabeçote

DESCRIPCIÓN / Descrição / Description **DIESEL**

ISUZU: D-Max D/DT 2007/... - Rodeo 2005/...
(5878153592)

MOTOR / Engine	CM ³	HP	Ø PISTON
4JK1-TC	2499	136	95.40
4JJ1-TC	2997	160	95.40

Juego Completo de Reparación:

Jogo de Juntas do Motor / Full Set Gasket:

JR-725-11

R

Semi-Juego de Reparación:

Semi-Jogo de Juntas / Semi-Set Gasket:

Juego de Descarbonización:

Jogo de Juntas Superior / Head Set Gasket:

JUNTA CULATA DE CILINDROS	TC-387-11	Ø 97.00mm	1.20mm	↑ ↓
Junta de cabeçote				↑ ↓
Cylinder Head gasket				↑ ↓

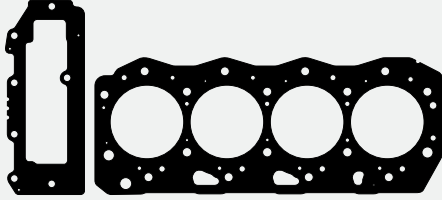

TC-387-11 - 8973288282/682
8981359530
Junta Culata de Cilindros
Junta Cabeçote



Junta Escape
Junta Escapamento



Junta

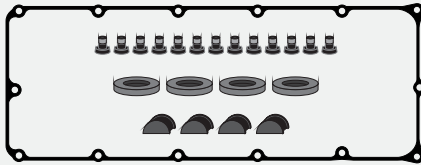

Junta Tapa Válvulas Superior
Junta Tampa Válvula Superior



Junta Admisión
Junta Admissão



Junta

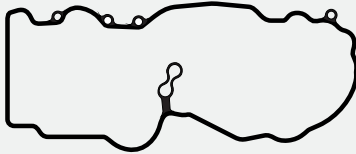

Junta Tapa Válvulas
Junta Tampa Válvulas



Bomba de agua
Bomba de água



Junta



Junta



Junta

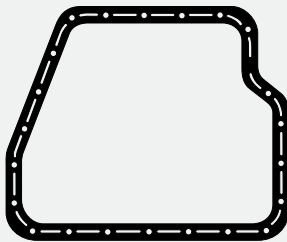

Junta Cártier
Junta Carter

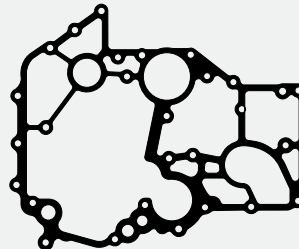

Junta Distribución
Junta Distribuição

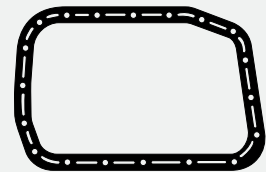

Junta Cártier
Junta Carter

Juego Ar. Met. y Goma/Jogo Arruelas Met. y Borracha



Juego Ret. Guía de Válvulas
Jogo Retentor da Haste de Válvulas



Retén Bancada
Retentor Traseiro do Virabrequim
50,00 x 68,00 x 9,00



Retén Distribución
Retentor Dianteiro do Virabrequim
95 x 118,00 x 9,5/13,00

R

Productos relacionados no incluidos en el juego. Los mismos pueden ser solicitados por separado.

Produtos relacionados não incluídos no jogo. Podem ser solicitados em separado.

Related products that were not included in the set but can be ordered separately.

Juego Completo de Reparación:

Jogo de Juntas do Motor / Full Set Gasket:

JR-726-11

DESCRIPCIÓN / Descrição / Description

DIESEL**ISUZU: D-Max DITD (8DH) 2002/...**
(5878143163)

MOTOR / Engine

CM³

HP

Ø PISTON

4JH1-TC

2997

131

95.40

ILLINOIS

ISUZU

Semi-Juego de Reparación:

Semi-Jogo de Juntas / Semi-Set Gasket:

Juego de Descarbonización:

Jogo de Juntas Superior / Head Set Gasket:

JUNTA CULATA DE CILINDROS	TC-389-11	Ø 96.50mm							
Junta de cabeçote									
Cylinder Head gasket									

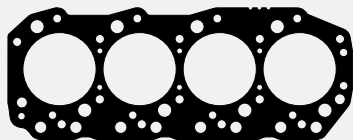

TC-389-11 -8974908951/61
8972596010
Junta Culata de Cilindros
Junta Cabeçote



Bomba de agua
Bomba d' água



Junta



Brida
Flange



Junta Admisión
Junta Admissão



Junta Escape
Junta Escapamento



Junta



Junta



Junta Tapa Válvula Superior
Junta Tampa Válvula Superior



Junta



Junta



Junta



Junta Cáster
Junta Carter

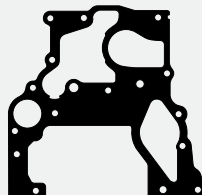

Placa distribución
Placa distribuição



Bancada
Mancal



Bancada
Mancal



Tapa distribución
Tampa distribuição



Juego Ret. Guía de Válvulas
Jogo Retenedor da Haste de Válvulas



Retén Bancada
Retenedor Traseiro do Virabrequim
50,00 x 68,00 x 9,00



Retén Distribución
Retenedor Dianteiro do Virabrequim
95,00 x 118,00 x 10,00



Productos relacionados no incluidos en el juego. Los mismos pueden ser solicitados por separado.

Produtos relacionados não incluídos no jogo. Podem ser solicitados em separado.

Related products that were not included in the set but can be ordered separately.

DESCRIPCIÓN / Descrição / Description **DIESEL**

ISUZU: Trooper 1992/... ELF 1993/...
Campo 1991/... (5878129040)

MOTOR / Engine	CM ³	HP	Ø PISTON
4JG2	3059	82	95.40
4JG2T	3059	109	95.40

Juego Completo de Reparación:

Jogo de Juntas do Motor / Full Set Gasket:

JR-680-11

R

Semi-Juego de Reparación:

Semi-Jogo de Juntas / Semi-Set Gasket:

Juego de Descarbonización:

Jogo de Juntas Superior / Head Set Gasket:

JUNTA CULATA DE CILINDROS	TC-919-11	Ø 96.50mm	1.60mm	1000000
Junta de cabeçote				1000000
Cylinder Head gasket				1000000

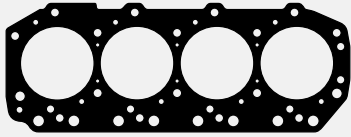

TC-919-11 - 8970661960/980/607637/608801/
97062774/970661968944337330
Junta Culata de Cilindros
Junta Cabeçote



Bomba de agua
Bomba de água



Junta



Junta Admisión
Junta Admissão



Junta Escape
Junta Escapamento



Brida
Flange



Junta Tapa Válvula Superior
Junta Tampa Válvula Superior



Junta



Bomba de agua
Bomba de água

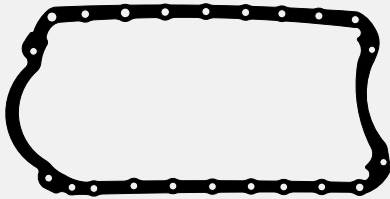

Junta Cártel
Junta Carter

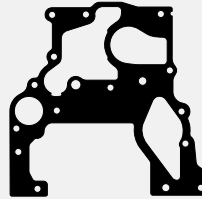

Placa distribución
Placa distribuição



Junta Cártel
Junta Carter



Tapa distribución
Tampa distribuição



Bancada
Virabrequim



Bancada
Virabrequim



Junta



Junta



Junta



Junta



Juego Retenes Guía de Válvulas
Jogo Retentor da Haste de Válvulas



Retén Bancada
Retentor Traseiro do Virabrequim



Retén Distribución
Retentor Dianteiro do Virabrequim

Productos relacionados no incluidos en el juego. Los mismos pueden ser solicitados por separado.

Produtos relacionados não incluídos no jogo. Podem ser solicitados em separado.

Related products that were not included in the set but can be ordered separately.

Juego Completo de Reparación:

Jogo de Juntas do Motor / Full Set Gasket:

JR-176-05**R****Semi-Juego de Reparación:**

Semi-Jogo de Juntas / Semi-Set Gasket:

Juego de Descarbonización:

Jogo de Juntas Superior / Head Set Gasket:

JD-286-05**R**

JUNTA CULATA DE CILINDROS	TC-299-05	∅ 80.50mm	1.80mm	↑ ↓
Junta de cabeçote				↑ ↓
Cylinder Head gasket				↑ ↓

DESCRIPCIÓN / Descrição / Description

JEEP: Willys - CPW Universal - Rastrojero
4 - 63 - 2WD - 4WD 1940/74
Guerrero 1941/43

MOTOR / Engine	CM ³	HP	∅ PISTON
CJ2A - CJ3A - DJ3A	2199	52	79.38

ILLINOIS

JEEP

JD-286-05

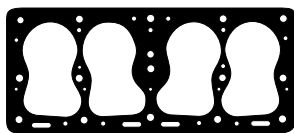

TC-299-05 - WOA8558US
Junta Culata de Cilindros
Junta Cabeçote



JAE-233 - W0638640
Múltiple Admisión y Escape
Coletor Admissão e Escapamento



JVS-157-30 - W0630305
Junta Tapa Válvula Superior
Junta Tampa Válvula Superior



JSA-140 - 2000695/2009067/W0634814
Salida Escape
Saída Escapamento



1023100 - W0639650
Bomba de agua
Bomba de água



1027000 - W0634811
Entre caño
Entre tubo



2630600 - W051875
Arandela 8 x 12,5 x 2mm
Arruela (Cobre)



1007000 - W0630299
Junta ventilación tapa de válvulas
Junta ventilação tampa válvulas



RT-5792
Retén Distribución
Ret. Dianteiro do Virabrequim
Mz 44,45 x 61,95 x 9,52



JC-187-30 - W0639980
Junta Cártér
Junta Carter

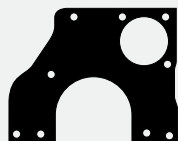

1024400 - W0630359
Tapa placa distribución
Tampa placa distribuição



1006800 - W0641096
Tapa distribución
Tampa distribuição

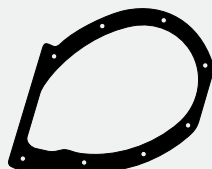

1023000 - W0630365
Tapa distribución
Tampa distribuição



1023200 - W0637053
Bomba de agua
Bomba de água



1006900 - W0630394
Bomba de aceite a block
Bomba de óleo ao bloco



1006300 - W0641482
Tapa bomba de aceite
Tampa bomba de óleo



1006400 - W0639870
Tapa bomba de aceite
Tampa bomba de óleo



1006700 - W0334103
Junta cigüeñal
Junta virabrequim



1006500 - W0638737
Bomba de combustible
Bomba de combustível



1021900 - WOA7280
Vaso de nafta
Copo de gasolina



2607700 - W0314338
Arandela 22 x 27 x 1,5mm
Arruela (Cobre)



1006600 - W0630398
Soporte filtro aceite
Suporte filtro óleo

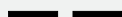

2752500 - W0637790
Guarnición goma
Guarnição borracha



1117900 - 731046
Juego bancada
Jogo virabrequim

Productos relacionados no incluidos en el juego. Los mismos pueden ser solicitados por separado.

Produtos relacionados não incluídos no jogo. Podem ser solicitados em separado.

Related products that were not included in the set but can be ordered separately.

DESCRIPCIÓN / Descrição / Description

JEEP: Renegade 2014/... Cherokee 2013/...
(68191818AA)

MOTOR / Engine	CM ³	HP	Ø PISTON
ED6	2360	175/180	88.00

Juego Completo de Reparación:

Jogo de Juntas do Motor / Full Set Gasket:

JR-808-11



Semi-Juego de Reparación:

Semi-Jogo de Juntas / Semi-Set Gasket:

Juego de Descarbonización:

Jogo de Juntas Superior / Head Set Gasket:

JUNTA CULATA DE CILINDROS	TC-670-11	Ø 89.50mm	0.80mm	↑ ↓
Junta de cabeçote				↑ ↓
Cylinder Head gasket				↑ ↓

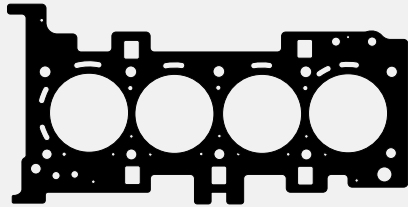

TC-670-11 - 6818889AF
Junta Culata de Cilindros
Junta Cabeçote



Junta



Junta



Junta Escape
Junta Escapamento



Juego Admisión
Jogo Admissão



Bomba de agua
Bomba d'água

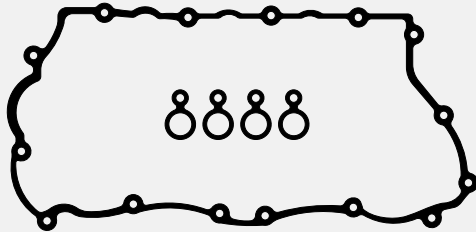

Junta Tapa Válvula Superior
Junta Tampa Válvula Superior



Arandela Goma
Arruela Borracha



Arandela Goma
Arruela Borracha



Juego Retenes Guía de Válvulas
Jogo Retentor da Haste de Válvulas



Retén Árbol de Leva
Retentor do Eixo Comando
de Válvulas



Retén Bancada
Retentor Traseiro do
Virabrequim



Productos relacionados no incluidos en el juego. Los mismos pueden ser solicitados por separado.

Produtos relacionados não incluídos no jogo. Podem ser solicitados em separado.

Related products that were not included in the set but can be ordered separately.

Juego Completo de Reparación:

Jogo de Juntas do Motor / Full Set Gasket:

JR-178-05**R**

DESCRIPCIÓN / Descrição / Description

JEEP IKA: Jeep Continental
Bergantin 1954/78 (2090523)

MOTOR / Engine

CM³

HP

Ø PISTON

4L - 151

2470

80

84.14

Juego de Descarbonización:

Jogo de Juntas Superior / Head Set Gasket:

JUNTA CULATA DE CILINDROS

TC-301-05

Ø 86.50mm

1.80mm

1.80mm

Junta de cabeçote

TC-301-02

Ø 86.50mm

1.90mm

Cylinder Head gasket

ILLINOIS

JEEP

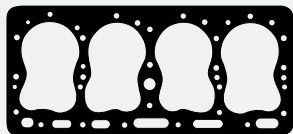
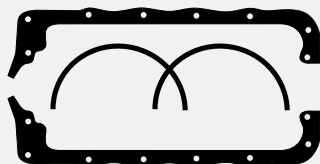
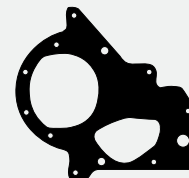
**TC-301-05** - 2009064/2000047
Junta Culata de Cilindros
Junta Cabeçote**JSA-140** - 2000695/2009067/WO634814
Salida Escape
Saída Escapamento**1048100** - 2000129
Caño múltiple
Cano múltiplo**JAE-235** - 2000050/2009065
Múltiple Admisión y Escape
Coletor Admissão e Escapamento**1024500** - 733809-711099
Bomba de agua
Bomba de água**1024600** - 733612
Base bomba de agua
Base bomba de água**JVL-154-30** - 2000343
Junta Tapa Válvula Lateral
Junta Tampa Válvula Lateral**1047200** - 12153
Cuerpo carburador
Corpo carburador**1025000** - 2000425
2016726/C3AZ9417C
Base bomba de nafta
Base bomba de gasolina**JC-190-30** - 2000169/2016713
Junta Cártier
Junta Carter**1024000** - 701290
Tapa distribución
Tampa distribuição**1024100** - 711930
Placa distribución
Placa distribuição**1048300** - 2002850/2000437
Base carburador
Base carburador**1047100** - 12154
Tapa carburador
Tampa carburador**1024300** - 731377
Salida agua
Saída água**1117900** - 731046
Juego bancada
Jogo mancal**RT-6694PoI**
Retén Distribución
Ret. Dianteiro do Virabrequim
Lz-R 52,40 x 81,00 x 11,00

Productos relacionados no incluidos en el juego. Los mismos pueden ser solicitados por separado.

Produtos relacionados não incluídos no jogo. Podem ser solicitados em separado.

Related products that were not included in the set but can be ordered separately.

**BU-084**
Bulones para Culata de Cilindros
Junta Cabeçote**JV-109**
Juego Caja Velocidad
Jogo Caixa de Câmbio

DESCRIPCIÓN / Descrição / Description **DIESEL**

KIA: Sportage TD 1996/... - Besta DE - Bongo Ceres 1992/...
MAZDA: 626TD 1993/97 - 323D 1998/...

MOTOR / Engine	CM ³	HP	Ø PISTON
RF	1998	83	86.00
RF - CX	1998	75/82	86.00
HW	2184	72	86.00

Juego Completo de Reparación:

Jogo de Juntas do Motor / Full Set Gasket:

JR-345

R

Semi-Juego de Reparación:

Semi-Jogo de Juntas / Semi-Set Gasket:

SJ-345

R

Juego de Descarbonización:

Jogo de Juntas Superior / Head Set Gasket:

JD-345

R

JUNTA CULATA DE CILINDROS	TC-961-11	Ø 87.50mm	1.50mm	↑ ↓
Junta de cabeçote		Ø		↑ ↓
Cylinder Head gasket		Ø		↑ ↓



JD-345

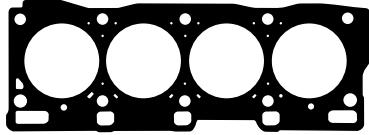

TC-961-11 - RF7110271F/RFJ510271A/D
 Junta Culata de Cilindros
 Junta Cabeçote



JAE-545-A - OK71013111
 Junta Admisión
 Junta Admissão

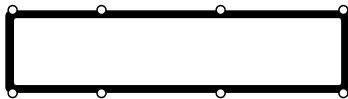

JVS-352-43 - OK77010235B
 Junta Tapa Válvula Superior
 Junta Tampa Válvula Superior



1013900 - ORF80110161
 Base termostato
 Base termostato



1011600 - OS71115173
 Termostato
 Termostato



JSA-308 - O63613483
 Salida Escape
 Saída Escapamento



JAE-544-E - OK71013462
 Junta Escape
 Junta Escapamento



1011000
 Bomba inyectora
 Bomba injetora

RT-893Pol
 Juego Retenes Guía de Válvulas
 Jogo Retentor da Haste de Válvulas

RT-8574Pol
 Retén Árbol de Levas
 Ret. do Eixo Comando de Válvulas
 30,00 x 44,00 x 7,00

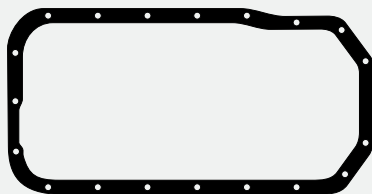

JC-373-30 - OK80111318
 Junta Cártér
 Junta Carter



1010300 - OK80111318
 Porta retén trasero
 Flange Traseiro do Virabrequim



2757800
 O'ring 56,82 x 2,62mm



2754500
 O'ring 17,12 x 2,62mm



2700900
 O'ring 20,30 x 2,62mm



1013300 - OK71015162
 Soporte bomba de aceite
 Suporte bomba de óleo



1020400
 Caño aceite
 Cano óleo

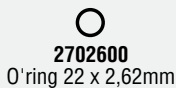

2702600
 O'ring 22 x 2,62mm



1020300 - OF80114248
 Filtro bomba
 Filtro bomba

RT-8429Vit
 Retén Bancada
 Retentor Traseiro do Virabrequim
 90,00 x 110,00 x 11,00

RT-8525Pol
 Retén Distribución
 Ret. Dianteiro do Virabrequim
 34,00 x 48,00 x 7,00

Productos relacionados no incluidos en el juego. Los mismos pueden ser solicitados por separado.

Produtos relacionados não incluídos no jogo. Podem ser solicitados em separado.

Related products that were not included in the set but can be ordered separately.



BU-520
 Bulones para Culata de Cilindros
 Parafusos de Cabeçote

Juego Completo de Reparación:

Jogo de Juntas do Motor / Full Set Gasket:

JR-544-07**R****Semi-Juego de Reparación:**

Semi-Jogo de Juntas / Semi-Set Gasket:

Juego de Descarbonización:

Jogo de Juntas Superior / Head Set Gasket:

JD-544-07**R**

JUNTA CULATA DE CILINDROS	TC-754-20	∅ 98.50mm	1.60mm	↑ ↓
Junta de cabeçote	TC-754-MG	∅ 98.50mm	1.60mm	↑ ↓
Cylinder Head gasket				↑ ↓

DESCRIPCIÓN / Descrição / Description

DIESEL**KIA: Besta GS 1998 (SOHC) - K2700 - Bongo Pregio**

MOTOR / Engine	CM ³	HP	∅ PISTON
J2	2665	78/83	94.50

ILLINOIS.

KIA

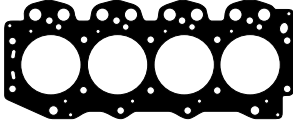
JD-544-07

TC-754-20 - 0K65A-10271B
Junta Culata de Cilindros
Junta Cabeçote



Junta Admisión
Junta Admissão

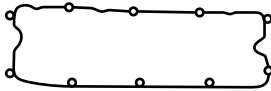

JVS-396-43
Junta Tapa Válvula Superior
Junta Tampa Válvula Superior



Salida Escape
Saída Escapamento



Junta Escape
Junta Escapamento

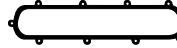

Guarnición
Guarnição



Guarnición
Guarnição



Guarnición
Guarnição



Soporte de sensor
Suporte de sensor



Bomba de agua
Bomba de água



Junta Carter
Junta Carter

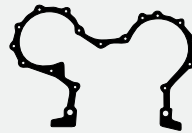

Distribución
Distribuição

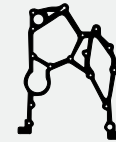

Soporte de ventilación
Suporte de ventilação



Porta retén
Flange retentor



Bomba inyectora
Bomba injetora



Guarnición
Guarnição



Bomba inyectora
Bomba injetora



Guarnición
Guarnição



Guarnición
Guarnição



RT-8835PaI
Retén Bancada
Retentor Traseiro
do Virabrequim
101,57 x 125 x 13



RT-8577PaI
Retén Distribución
Retentor Dianteiro
do Virabrequim
51,00 x 70,00 x 11,00

R

Productos relacionados no incluidos en el juego. Los mismos pueden ser solicitados por separado.

Produtos relacionados não incluídos no jogo. Podem ser solicitados em separado.

Related products that were not included in the set but can be ordered separately.

DESCRIPCIÓN / Descrição / Description **DIESEL**

KIA: Besta GS/Grand 2000/05 - Pregio

MOTOR / Engine	CM ³	HP	Ø PISTON
JT/JTA 8V	2956	85	98.00

Juego Completo de Reparación:

Jogo de Juntas do Motor / Full Set Gasket:

JR-748-07

R

Semi-Juego de Reparación:

Semi-Jogo de Juntas / Semi-Set Gasket:

Juego de Descarbonización:

Jogo de Juntas Superior / Head Set Gasket:

JD-748-07

R

JUNTA CULATA DE CILINDROS	TC-913-07	Ø 101.00mm	1.50mm	↑ ↓
Junta de cabeçote		Ø		↑ ↓
Cylinder Head gasket		Ø		↑ ↓



JD-748-07

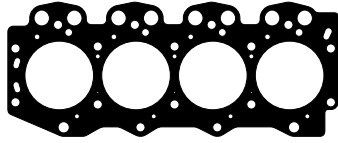

TC-913-07 - OK75A10271
Junta Culata de Cilindros
Junta Cabeçote



Salida Escape
Saída Escapamento



Juego Admisión
Jogo Admissão



Junta Admisión
Junta Admissão



Junta Escape
Junta Escapamento



Soporte de sensor
Suporte de sensor

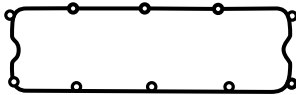

JVS-396-43
Junta Tapa Válvula Superior
Junta Tampa Válvula Superior



Guarnición
Guarnição



Bomba de agua
Bomba d'água



Junta Cártel
Junta Carter



Soporte de ventilación
Suporte de ventilação

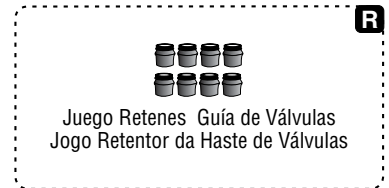

Juego Retenes Guía de Válvulas
Jogo Retentor da Haste de Válvulas



Porta retén
Porta retentor

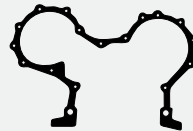

Distribución
Distribuição



Guarnición
Guarnição



Bomba inyectora
Bomba injetora



Guarnición
Guarnição



Guarnición
Guarnição



Bomba inyectora
Bomba injetora

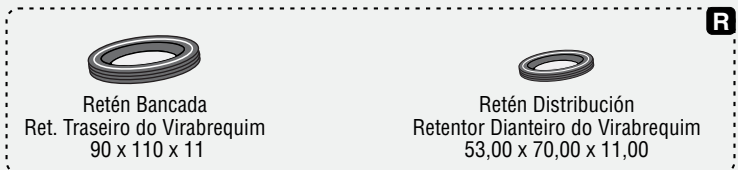

Retén Bancada
Ret. Traseiro do Virabrequim
90 x 110 x 11

Retén Distribución
Retentor Dianteiro do Virabrequim
53,00 x 70,00 x 11,00

Productos relacionados no incluidos en el juego. Los mismos pueden ser solicitados por separado.

Produtos relacionados não incluídos no jogo. Podem ser solicitados em separado.

Related products that were not included in the set but can be ordered separately.

Juego Completo de Reparación:

Jogo de Juntas do Motor / Full Set Gasket:

JR-447-15**R****Semi-Juego de Reparación:**

Semi-Jogo de Juntas / Semi-Set Gasket:

SJ-447**R****Juego de Descarbonización:**

Jogo de Juntas Superior / Head Set Gasket:

JD-447-15**R**

JUNTA CULATA DE CILINDROS	TC-542-15	Ø 81.00mm	1.40mm	↕
Junta de cabeçote				↕
Cylinder Head gasket				↕

DESCRIPCIÓN / Descrição / Description

LADA: Laica - Niva - 2101 - 2102 1970/...
2103 - 2107 1972/... (21011004024)

MOTOR / Engine	CM ³	HP	Ø PISTON
OHC	1198	60	76.00
OHC	1452	75	76.00

ILLINOIS

LADA

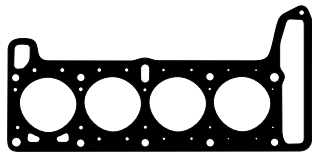
**JD-447-15**

TC-542-15 - 21011003020
Junta Culata de Cilindros
Junta Cabeçote



JAE-110 - 21011008081
Múltiple Admisión y Escape
Coletor Admissão e Escapamento

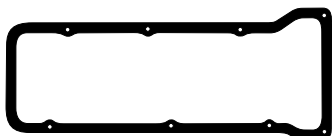

JVS-295-30 - 21011003270
Junta Tapa Válvula Superior
Junta Tampa Válvula Superior



1069600 - 21011303038
Junta calefactor
Junta aquecedor



JSA-188-11 - 4309031
Salida Escape
Saída Escapamento



1047800 - 0608201900
21081107990/7702086169
Base carburador
Base carburador



1068500 - 2101100608
Base bomba de aceite
Base bomba de óleo



RT-552Pol
Jgo. Ret. Guía de Válvulas
Jogo Retenedor da Haste de Válvulas

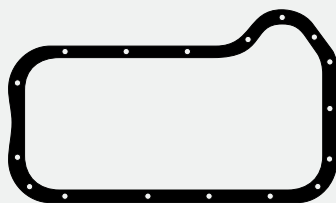

JC-331-30 - 21011003070
Junta Cártar
Junta Carter



1044000 - 21051002064
Placa distribución
Placa distribuição

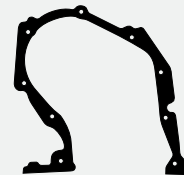

1041200 - 21011002064
Tapa distribución
Tampa distribuição



1198700 - 21011106170/4081258
Base bomba de nafta
Base bomba de gasolina



1031000 - 21011011021
Bomba de aceite a block
Bomba de óleo ao bloco



1013800 - 21011303017
Carcasa termostato
Carcaça termostato



1031100 - 4129763
21011005155
Tapa retén bancada
Tampa retentor mancal



1072900 - 21011307046
Tapa bomba de agua
Tampa bomba de água



1013700 - 21051005255
Tapa árbol de levas
Tampa árvore de comando



1071200 - 21011307048
Placa bomba de agua
Placa bomba de água



RT-6677Pol
Retén Bancada Lx-R
Ret. Traseiro do Virabrequim
70,00 x 90,00 x 10,00



RT-6123Pol
Retén Distribución Mx-R
Retenedor Dianteiro do Virabrequim
40,00 x 56,00 x 7,00

Productos relacionados no incluidos en el juego. Los mismos pueden ser solicitados por separado.

Produtos relacionados não incluídos no jogo. Podem ser solicitados em separado.

Related products that were not included in the set but can be ordered separately.



JSA-188-17 - 4309031
Salida Escape
Saída Escapamento

DESCRIPCIÓN / Descrição / Description

M. BENZ: A160 1997/04 - A140 - Vaneo 2001/...

MOTOR / Engine	CM ³	HP	Ø PISTON
MB166.960/961	1598	82	80.00

Juego Completo de Reparación:

Jogo de Juntas do Motor / Full Set Gasket:

JR-677-11

Semi-Juego de Reparación:

Semi-Jogo de Juntas / Semi-Set Gasket:

Juego de Descarbonización:

Jogo de Juntas Superior / Head Set Gasket:

JUNTA CULATA DE CILINDROS	TC-671-11	Ø 81.00mm	0.80mm	↑ ↓
Junta de cabeçote				↑ ↓
Cylinder Head gasket				↑ ↓

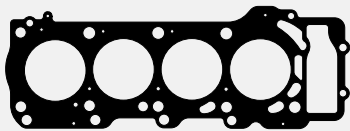

TC-671-11 - 1660160120
Junta Culata de Cilindros
Junta Cabeçote



Junta



Junta



Junta Escape
Junta Escapamento



Juego Admisión
Jogo Admissão



Junta

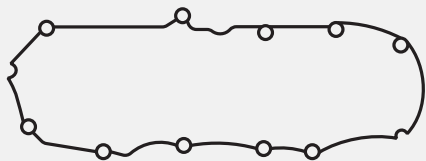

Junta Tapa Válvula Superior
Junta Tampa Válvula Superior



Bomba de agua
Bomba de água

Productos relacionados no incluidos en el juego. Los mismos pueden ser solicitados por separado.

Produtos relacionados não incluídos no jogo. Podem ser solicitados em separado.

Related products that were not included in the set but can be ordered separately.

Juego Completo de Reparación:

Jogo de Juntas do Motor / Full Set Gasket:

JR-183-20**Semi-Juego de Reparación:**

Semi-Jogo de Juntas / Semi-Set Gasket:

Juego de Descarbonización:

Jogo de Juntas Superior / Head Set Gasket:

JUNTA CULATA DE CILINDROS	TC-320-20	∅ 76.00mm	1.60mm	↕
Junta de cabeçote				↕
Cylinder Head gasket				↕

DESCRIPCIÓN / Descrição / Description

DIESEL**FAHR:** 177D - 177S**MERCEDES BENZ:** 170D - 180D 1940/62
180DB - O319D - L405 - L406 - 170DS/SD
F1000 - N1000 - 170DB

MOTOR / Engine	CM ³	HP	∅ PISTON
OM 136	1696	40	73.50
OM 636	1767	45	75.00
MB 636-916/18	1767	45	75.00
19/30/31/34			

ILLINOIS

M. BENZ

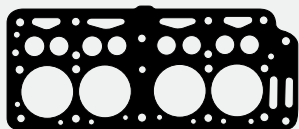

TC-320-20 - 6360160820
Junta Culata de Cilindros
Junta Cabeçote

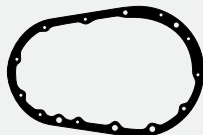

1137900 - 1360150120
Tapa distribución
Tampa distribuição



1138100 - 6360160080
Caja de velocidad
Caixa de Câmbio



JAE-245 - 6361410279/6361420680
Múltiple Admisión y Escape
Coletor Admissão e Escapamento

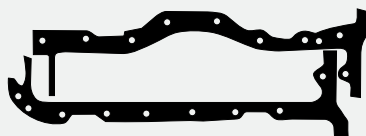

JC-274-34
Junta Cártel
Junta Carter



1138400 - 636011180
Tapa de admisión
Tampa de admissão



JVS-161-30 - 6360160180
Junta Tapa Válvula Superior
Juna Tampa Válvula Superior



JVL-169-30 - 6360150180
Junta Tapa Válvula Lateral
Junta Tampa Válvula Lateral

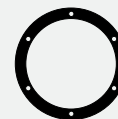

1137800 - 6360150280
Tapa distribución
Tampa distribuição



1138200 - 6361840580
Bomba de aceite
Bomba de óleo



1138300 - 1532010080
Bomba de agua
Bomba de água



1138000 - 6360740480
Bomba inyectora
Bomba injetora



1137400 - 6361840380
Filtro de aceite
Filtro de óleo



1185300
Chupador de aceite
Pescador óleo

Productos relacionados no incluidos en el juego. Los mismos pueden ser solicitados por separado.

Produtos relacionados não incluídos no jogo. Podem ser solicitados em separado.

Related products that were not included in the set but can be ordered separately.

DESCRIPCIÓN / Descrição / Description

M. BENZ: Clase A 190 1999/... - Clase A 210 Evolution 2002/... - Vaneo 2001/...

MOTOR / Engine	CM ³	HP	Ø PISTON
MB166.990	1898	125	84.00
MB166.991	1898	125	84.00
MB166.995	2084	140	84.00

Juego Completo de Reparación:

Jogo de Juntas do Motor / Full Set Gasket:

Semi-Juego de Reparación:

Semi-Jogo de Juntas / Semi-Set Gasket:

Juego de Descarbonización:

Jogo de Juntas Superior / Head Set Gasket:

JD-742-07



JUNTA CULATA DE CILINDROS	TC-946-07	Ø 85.00mm	1.70mm	↑ ↓
Junta de cabeçote				↑ ↓
Cylinder Head gasket				↑ ↓

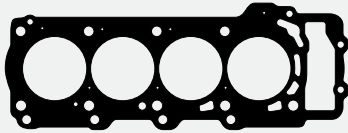

TC-946-07 - 1660160220
Junta Culata de Cilindros
Junta Cabeçote



Junta



Junta



Juego Admisión
Jogo Admissão



Junta Escape
Junta Escapamento



Junta

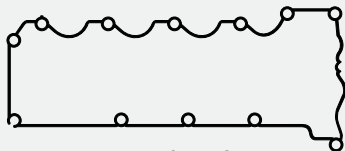

Junta Tapa Válvula Superior
Junta Tampa Válvula Superior



Junta



Juego Retenes Guía de Válvulas
Jogo Retentor da Haste de Válvulas



Retén Distribución
Ret. Dianteiro do Virabrequim
40,00 x 62,00 x 8,00

Productos relacionados no incluidos en el juego. Los mismos pueden ser solicitados por separado.

Produtos relacionados não incluídos no jogo. Podem ser solicitados em separado.

Related products that were not included in the set but can be ordered separately.

Juego Completo de Reparación:

Jogo de Juntas do Motor / Full Set Gasket:

JR-822-11

DESCRIPCIÓN / Descrição / Description

DIESEL**M.BENZ:** Sprinter - Vito 2012/...
Viano 2010/... CDI**Semi-Juego de Reparación:**

Semi-Jogo de Juntas / Semi-Set Gasket:

Juego de Descarbonización:

Jogo de Juntas Superior / Head Set Gasket:

JUNTA CULATA DE CILINDROS	TC-822-11	∅ 84.00mm	1.40mm	↑ ↓
Junta de cabeçote				↑ ↓
Cylinder Head gasket				↑ ↓

MOTOR / Engine	CM ³	HP	∅ PISTON
OM651.940/955	2143	95	83.00

ILLINOIS.

M. BENZ

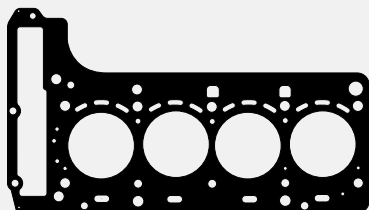

TC-822-11 - 6510160500
Junta Culata de Cilindros
Junta Cabeçote



Junta Admisión
Junta Admissão



Junta

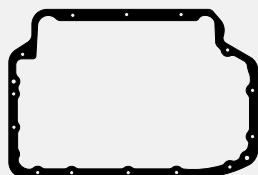

Junta Cáster
Junta Carter

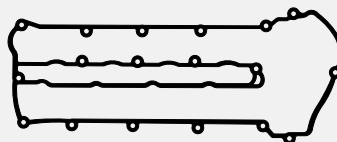

Junta Tapa Válvula Superior
Junta Tampa Válvula Superior



Junta Escape
Junta Escapamento



Retén Bancada
Retentor Traseiro do Virabrequim
114 x 96 x 9



Retén Distribución
Retentor Dianteiro do Virabrequim
60 x 75 x 7



Juego Retenes Guía de Válvulas
Jogo Retentor da Haste de Válvulas

R

Productos relacionados no incluidos en el juego. Los mismos pueden ser solicitados por separado.

Produtos relacionados não incluídos no jogo. Podem ser solicitados em separado.

Related products that were not included in the set but can be ordered separately.

DESCRIPCIÓN / Descrição / Description **DIESEL**

M. BENZ: Sprinter 413/411/313/208/211/213
 CDI 2000/... - C200/C220/E200/E220 1998/...
 Vito 108/110/112 CDI Iny. Directa 16V
 (6110104520)

MOTOR / Engine	CM ³	HP	Ø PISTON
OM611 CDI 611.980/981	2151	82/129	88.00
MB611.960 (DOHC)	2151	102/125	88.00
MB611.961 (DOHC)	2151	100/123	88.00

Juego Completo de Reparación:

Jogo de Juntas do Motor / Full Set Gasket:

Semi-Juego de Reparación:

Semi-Jogo de Juntas / Semi-Set Gasket:

SJ-543

R

Juego de Descarbonización:

Jogo de Juntas Superior / Head Set Gasket:

JD-543-ST

R

JUNTA CULATA DE CILINDROS	TC-901 1M	Ø 89.00mm	1.20mm	de 0,38 a 0,62mm
Junta de cabeçote	TC-901 2M	Ø 89.00mm	1.40mm	de 0,63 a 0,80mm
Cylinder Head gasket				

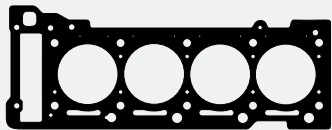

TC-901-20 1M TC-901-MG 1M
TC-901-20 2M TC-901-MG 2M
 6110160620/920 - 646016520
 Junta Culata de Cilindros
 Junta Cabeçote

JD-543-ST



2749100
 Juego salida tapa cilindros
 Jogo saída cabeçote



RT-565Pol
 Jgo. Ret. Guía de Válvulas
 Jogo Retentor da Haste de Válvulas



JAE-521-E - 6111420380
 Junta Escape
 Junta Escapamento



JAE-522-A - 6110980380
 Junta Admisión
 Junta Admissão



2749300 - 6112030380
 Base termostato
 Base termostato

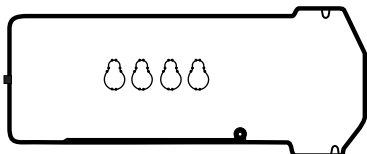

JVS-335-43 - 6110160121
 Junta Tapa Válvula Superior
 c/protectores bujía
 Junta Tampa Válvulas Superior
 c/protetores vela



2749400 - 6110980280
 Juego cierre colector admisión
 Jogo fechamento coletor admissão



2749200 - 6110980180
 Colector admisión
 Coletor admissão



2615900
 Arandela 15 x 20 x 1mm
 Arruela (Cobre)



2630000
 Arandela 8 x 14 x 1,5mm
 Arruela (Cobre)



2710500
 O'ring 44 x 3mm

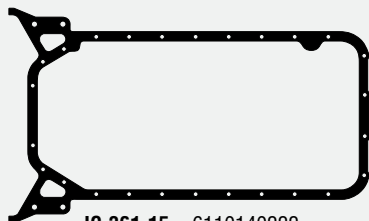

JC-361-15 - 6110140222
 Junta Cártier
 Junta Carter



1131700 - 6112010280
 Bomba de agua
 Bomba d'água



2755800 - 352436
 Enfriador aceite
 Resfriador óleo



2629900
 Arandela 27 x 32 x 2mm
 Arruela (Aluminio)



2625200
 Arandela 12 x 17 x 1,5mm
 Arruela (Cobre)



1132600
 Brida
 Flange



1185300
 Chupador de aceite
 Pescador de óleo

Productos relacionados no incluidos en el juego. Los mismos pueden ser solicitados por separado.

Produtos relacionados não incluídos no jogo. Podem ser solicitados em separado.

Related products that were not included in the set but can be ordered separately.



BU-219
 Bulones para Culata de Cilindros
 Parafusos de Cabeçote



JT-142
 Juego Turbo
 Jogo Turbo

Juego Completo de Reparación:

Jogo de Juntas do Motor / Full Set Gasket:

JR-303-20**Semi-Juego de Reparación:**

Semi-Jogo de Juntas / Semi-Set Gasket:

SJ-303**Juego de Descarbonización:**

Jogo de Juntas Superior / Head Set Gasket:

JUNTA CULATA DE CILINDROS	TC-775-20	∅ 92.00mm	1.70mm	↑ ↓
Junta de cabeçote	TC-775-07	∅ 92.00mm	1.70mm	↑ ↓
Cylinder Head gasket				↑ ↓

DESCRIPCIÓN / Descrição / Description

DIESEL

MERCEDES BENZ: 240D/TD 1973/... - L406/407DG
207/307/407/507/510D - 0309D 1977/...
240GD 76/87 - MB100/150/170/200 - MB400/180D

MOTOR / Engine	CM ³	HP	∅ PISTON
MB616.912/934/960	2404	65	91.00
MB616.916/940	2404	72	91.00
MB616.961/963	2404	72	91.00

ILLINOIS

M. BENZ

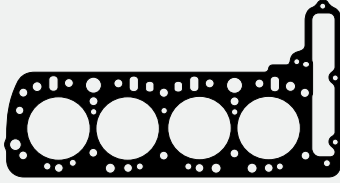

TC-775-20 - 6160162020
6210100321/100009500
Junta Culata de Cilindros
Junta Cabeçote



1021100
Cuerpo aceite
Corpo óleo



1021200
Bomba hidráulica
Bomba hidráulica



1021300
Junta



JAE-391 - 6211421180
Múltiple Admisión y Escape
Coletor Admissão e Escapamento



1051600 - 6162030280
Acople termostato
Acoplamento termostato



1052000
Junta



1052100
Termostato
Termostato

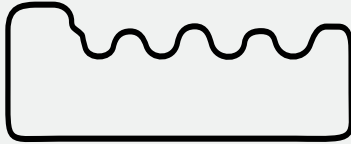

JVS-353-43 - 6150160080
Junta Tapa Válvula Superior
Junta Tampa Válvula Superior

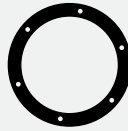

1020500 - 6162010180
Bomba vacío
Bomba vácuo



1020600
Intercambiador
Intertrocador



1021000 - 6161841280
Base filtro aceite
Base filtro óleo

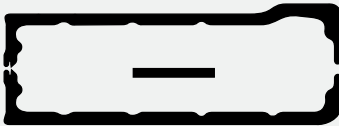

JC-374-26
Junta Cáster
Junta Carter



1025100
Junta



1037700
Junta



1038000 - 6170520280
Tensor hidráulico
Tensor hidráulico



1052400 - 0019971241
Empaquetadura bancada
Junta mancal



1185300
Chupador de aceite
Pescador de óleo



2705000
O'ring 6,07 x 1,78mm



2721400
O'ring 7,59 x 2,62mm



2608500
Arandela 14 x 18 x 1,5mm
Arruela (Aluminio)



2617900
Arandela 26 x 32 x 2mm
Arruela (Aluminio)



2632300
Arandela 28 x 34 x 1,5mm
Arruela (Aluminio)



2708900
O'ring 25,62 x 2,43mm

Productos relacionados no incluidos en el juego. Los mismos pueden ser solicitados por separado.

Produtos relacionados não incluídos no jogo. Podem ser solicitados em separado.

Related products that were not included in the set but can be ordered separately.



BU-521
Bulones para
Culata de Cilindros
Parafusos de Cabeçote

DESCRIPCIÓN / Descrição / Description **DIESEL**

CHEVROLET: S10 TD - Blazer TD 2000/...
AGRALE: Agrale TD (Micro-Omnibus) 2000/...
 6000 Furgon Van **VOLKSWAGEN:** LTDI 1997/...
NISSAN: Frontier - X Terra TD 12V **VOLARE:** A5/6/8

MOTOR / Engine	CM ³	HP	Ø PISTON
AGK	2796	125	93.00
ATA	2796	131	93.00
Sprint 4.07 TCA	2796	132	93.00

Juego Completo de Reparación:

Jogo de Juntas do Motor / Full Set Gasket:

Semi-Juego de Reparación:

Semi-Jogo de Juntas / Semi-Set Gasket:

SJ-347



Juego de Descarbonización:

Jogo de Juntas Superior / Head Set Gasket:

JD-347-ST



JUNTA CULATA DE CILINDROS	TC-658 0M	Ø 96.00mm	1.40mm	±0.05
Junta de cabeçote	TC-658 1M <td>Ø 96.00mm <td>1.70mm <td>±0.05</td> </td></td>	Ø 96.00mm <td>1.70mm <td>±0.05</td> </td>	1.70mm <td>±0.05</td>	±0.05
Cylinder Head gasket				

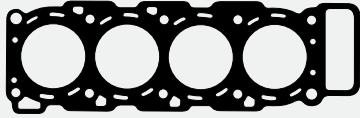

TC-658-20 0M TC-658-MG 0M
TC-658-20 1M TC-658-MG 1M
 940708548074/M5B85402
 Junta Culata de Cilindros
 Junta Cabeçote

JD-347-ST



1188500 - 940708530054
 Termostato
 Termostato



2703900 - 940708610074
 Buje 2 dientes
 Bucha 2 dentes



JAE-240-A - 940708530084
 Junta Admisión
 Junta Admissão



JAE-439-E - 960708530084
 Juego Escape
 Jogo Escapamento



JSA-293 - 93284251
 Salida Escape
 Saída Escapamento



RT-0785J
 Jgo. Ret. Guía Válvulas
 Jogo Ret. da Haste de Válv.



JVS-296-43 - 940708530034/M5B85302
 Junta Tapa Válvula Superior c/bujes
 Junta Tampa Válvula Superior c/buchas

2727500 - Juego Arandelas de Goma/Jogo Arruelas de Borracha

Gráfico	Descripción/Descrição	Cant./Quant.
	O'ring 105,5x3,5mm	1
	O'ring 82x3,5mm	1
	O'ring 76x2,5mm	1
	O'ring 66,5x3,5mm	1
	O'ring 44x2,8mm	1
	O'ring 40,6x3,5mm	1
	O'ring 32,5x3,5mm	1
	O'ring 22x2,6mm	1

2612300 - Juego Arandelas Metálicas/Jogo Arruelas Metálicas

Gráfico	Descripción/Descrição	Cant./Quant.
	Aran./Arruela 21x30x2mm Aluminio	2
	Ar./Arruela 20x24x1,5mm Aluminio	2
	Ar./Arruela 18x22x1,5mm Aluminio	2
	Aran./Arruela 16x20x1mm Aluminio	5
	Aran./Arruela 14x18x1,5mm Cobre	2
	Ar./Arruela 14x18x1,5mm Aluminio	5
	Ar./Arruela 12x18x1,5mm Aluminio	5
	Aran./Arruela 10x14x1mm Aluminio	5
	Aran./Arruela 7x14x2mm Cobre	4
	Aran./Arruela 8x12x1mm Cobre	29
	Aran./Arruela 6x10x1mm Cobre	13



JC-332-26 - 940708530014
 Junta Cártér
 Junta Carter

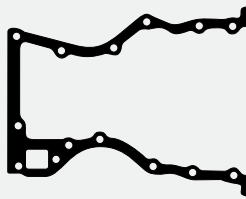

1188400 - 940708530124
 Distribución
 Distribuição

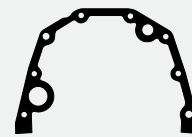

1096600 - 940708530184/01
 Bomba de aceite
 Bomba de óleo



1188800 - 941008530094
 Bomba inyectora
 Bomba injetora



1188600 - 940708530134
 Interior radiador aceite
 Interior radiador óleo

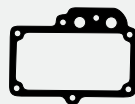

1188700 - 940708530094
 Tapa radiador aceite
 Tampa radiador óleo



RT-9664Vit
 Retén Distribución
 Ret. Dianteiro do Virabrequim
 A 278-R 64,00 x 80,00 x 9,00



RT-9663Vit
 Retén Bancada
 Retentor Traseiro do Virabrequim
 A 278-R 91,00 x 110,00 x 10,00

Productos relacionados no incluidos en el juego. Los mismos pueden ser solicitados por separado.

Produtos relacionados não incluídos no jogo. Podem ser solicitados em separado.

Related products that were not included in the set but can be ordered separately.



BU-511
 Bulones para Culata de Cilindros
 Parafusos de Cabeçote



JT-115
 Juego Turbo
 Jogo Turbo



JAE-439-09 - 960708530084
 Juego Escape
 Jogo Escapamento



JAE-440-A - 940708530084
 Junta Admisión (Corcho y Goma)
 Junta Admissão (cortiça e borracha)

Juego Completo de Reparación:

Jogo de Juntas do Motor / Full Set Gasket:

JR-329-20**Semi-Juego de Reparación:**

Semi-Jogo de Juntas / Semi-Set Gasket:

SJ-247**Juego de Descarbonización:**

Jogo de Juntas Superior / Head Set Gasket:

JD-165-20

JUNTA CULATA DE CILINDROS	TC-520-20	Ø 110.00mm	1.60mm		
Junta de cabeçote					
Cylinder Head gasket					

DESCRIPCIÓN / Descrição / Description

DIESEL

AGRALE: Tractor 5075.4 - 5085.4/5 - BX6110 - 88
FORD: F100 93/95 - F1000 94/96 - F4000 92/93 - F2000 1980/..
FB4000 1985/... - VALMET: 78/88/880/980 4x4
VOLKSWAGEN: 6.90/7.90/7.110 - **FIAT:** Excavadora FB80
 (922900134317/1997/3237/2338)

MOTOR / Engine	CM ³	HP	Ø PISTON
D229-4	3922	96	102.00

ILLINOIS

M.W.M.



TC-520-20 - 622708541044
 922908541044
 Junta Culata de Cilindros
 Junta Cabeçote

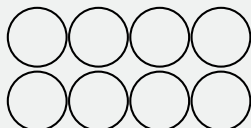

2745100
 604931040062/1104
 Arandela camisa (Silicona)
 Arruela camisa (Silicone)



JAE-342-A - 632138530094
 Juego Admisión
 Jogo Admissão



JAE-343-E - 620708530074
 Juego Escape
 Jogo Escapamento



JSA-190 - 623208520034
 922908530014
 Salida Escape
 Saída Escapamento

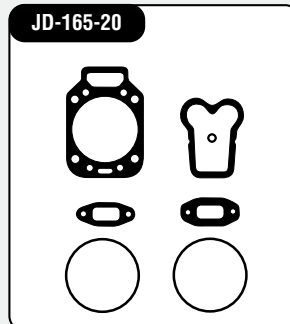

JSA-202
 922508510014
 Salida Escape
 Saída Escapamento



JVS-272-43 - 922908530444
 920808530014
 Junta Tapa Válvula Sup. c/arandelas
 Junta Tampa Válvula Sup. c/arruelas



1124300 - 922208530134
 Bomba de agua
 Bomba de água



1123900
 632488510144
 Filtro de aire
 Filtro ar



1123800 - 630508530154
 Brida escape
 Flange escapamento

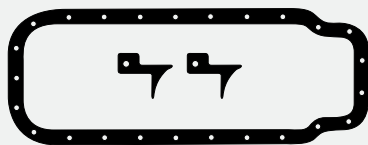

JC-287-26 - 630508530144
 922908530406/922908530157
 Junta Cáster
 Junta Carter



1124000 - 632508530054
 Tapa trasera
 Tampa traseira



1124600 - 922508530014
 Intercambiador
 Intertrocador

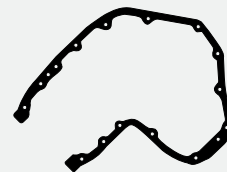

1124200 - 632508530184
 Distribución
 Distribuição



1124100
 632508530154
 Tapa engr. distribución
 Tampa engr. distribuição



1124800
 90411025015
 Brida
 Flange



1124500
 922508510044
 Tapa inspección
 Tampa inspeção



1123600
 620608530014
 962608530014
 Base bomba de agua
 Base bomba de água



1124400
 922508500014
 Volante
 Volante



1123700
 620808510014
 Colector escape
 Coletor escapamento



1124700
 930508530214
 Filtro aceite
 Filtro óleo



RT-8420Vit
 Retén Distribución
 Ret. Dianteiro do Virabrequim
 Lx-Hel 78 x 100 x 13



RT-8421Vit
 Retén Bancada
 Ret. Tras. do Virabrequim
 Lx-Hel 110 x 130 x 13

**2747900 - Juego Arandelas de Goma/Jogo Arruelas de Borracha**

Gráfico	Descripción/Descrição	Cant./Quant.
	54327541 1 Cil. Arandelas/Arruelas	8
	50005741 O'ring 20x4 mm	1
	O'ring 44x3mm	1
	O'ring 42,2x3mm	2
	O'ring 32x3,8mm	1
	O'ring 20x2mm	4
	O'ring 6x2mm	1

2628000 - Juego Arandelas Metálicas/Jogo Arruelas Metálicas

Gráfico	Descripción/Descrição	Cant./Quant.
	Aran./Arruela 22x27x1mm Aluminio	1
	Aran./Arruela 20x26x1mm Cobre	1
	Ar./Arruela 14x20x1,5mm Aluminio	2
	Ar./Arruela 14x18x1,5mm Aluminio	16
	Ar./Arruela 12x18x1,5mm Aluminio	2
	Aran./Arruela 10x20x2mm Cobre	4
	Aran./Arruela 10x14x1,5mm Alum.	4
	Aran./Arruela 8x14x1mm Aluminio	3

Productos relacionados no incluidos en el juego. Los mismos pueden ser solicitados por separado.

Produtos relacionados não incluídos no jogo. Podem ser solicitados em separado.

Related products that were not included in the set but can be ordered separately.



BU-021
 Bulones para Culata de Cilindros
 Parafusos de Cabeçote



JSA-206-21
 Salida Escape (Anillo Malla Acero)
 Saída Escapamento (Anel Malha Aço)



JSA-206-22
 Salida Escape
 Saída Escapamento (Fundición/Ferro)



JV-149
 Juego Caja Velocidad
 Jogo Caixa de Câmbio

DESCRIPCIÓN / Descrição / Description **DIESEL**

FORD: F100 GMC Turbo 1999/...
GM CHEVROLET: GM Silverado 3500HD
 DLX 1997/... - GM Grand Blazer 1998/...

MOTOR / Engine	CM ³	HP	Ø PISTON
Sprint 6.07 TD	4200	167	93.00
Turb. Intercooler	4200	198	93.00

Juego Completo de Reparación:

Jogo de Juntas do Motor / Full Set Gasket:

Semi-Juego de Reparación:

Semi-Jogo de Juntas / Semi-Set Gasket:

SJ-348

R

Juego de Descarbonización:

Jogo de Juntas Superior / Head Set Gasket:

JD-348-ST

R

JUNTA CULATA DE CILINDROS	TC-659-20 0M	TC-659-20 1M	96.00mm	96.00mm	1.40mm	1.70mm
Junta de cabeçote						
Cylinder Head gasket						

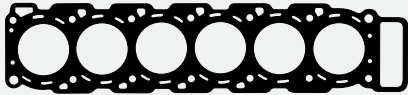

TC-659-20 0M - 960708548164
TC-659-20 1M
 Junta Culata de Cilindros
 Junta Cabeçote

JD-348-ST



2703700
 Guarnición termostato
 Guarnição termostato



1191500 - 960708530074
 Retorno aceite
 Retorno óleo



2703900 - 940708610074
 Buje 2 dientes
 Bucha 2 dentes



JAE-442-A - 960708530064
 Junta Admisión
 Junta Admissão



JAE-441-E - 960708530084
 Juego Escape
 Jogo Escapamento



JSA-293 - 93284251
 Salida Escape
 Saída Escapamento



RT-2972Vit
 Jgo. Ret. Guía Válvulas
 Jogo Ret. da Haste de Válv.

R



JVS-297-43 - 960708530014
 Junta Tapa Válvula Superior c/bujes
 Junta Tampa Válvula Superior c/bujas

2727600 - Juego Arandelas de Goma/Jogo Arruelas de Borracha

Gráfico	Descripción/Descrição	Cant./Quant.
○	O'ring 105,5x3,5mm	2
○	O'ring 82x3,5mm	1
○	O'ring 76x2,5mm	2
○	O'ring 66,5x3,5mm	1
○	O'ring 44x2,8mm	1
○	O'ring 40,6x3,5mm	1
○	O'ring 40x5mm	1
○	O'ring 32,5x3,5mm	1
○	O'ring 31x2,7mm	1
○	O'ring 28x3,5mm	1
○	O'ring 22x2,6mm	1
○	O'ring 13x1,8mm	1

2612400 - Juego Arandelas Metálicas/Jogo Arruelas Metálicas

Gráfico	Descripción/Descrição	Cant./Quant.
○	Aran./Arruela 21x30x2mm Aluminio	1
○	Ar./Arruela 20x24x1,5mm Aluminio	4
○	Ar./Arruela 18x22x1,5mm Aluminio	5
○	Aran./Arruela 16x20x1mm Aluminio	3
○	Ar./Arruela 14x18x1,5mm Aluminio	8
○	Ar./Arruela 12x18x1,5mm Aluminio	6
○	Aran./Arruela 7x15x2mm Cobre	6
○	Aran./Arruela 10x14x1mm Aluminio	4
○	Aran./Arruela 8x14x1mm Aluminio	2
○	Aran./Arruela 8x12x1mm Cobre	41
○	Aran./Arruela 8x12x1mm Aluminio	5
○	Aran./Arruela 6x10x1mm Cobre	18



JC-333-26 - 960708530094
 Junta Cártér
 Junta Carter

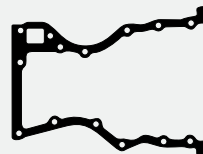

1188400 - 940708530124
 Distribución
 Distribuição



1096600 - 940708530184/01
 Bomba de aceite
 Bomba de óleo



1191300 - 960708530054
 Base termostato N°1
 Base termostato N°1



1188700 - 940708530094
 Tapa radiador aceite
 Tampa radiador óleo



1188600 - 940708530134
 Interior radiador aceite
 Interior radiador óleo



1191400
 Base termostato N°2
 Base termostato



RT-9663Vit
 Retén Bancada
 Ret. Traseiro do Virabrequim
 A 278-R 91 x 110 x 10



RT-9664Vit
 Ret. Distribución
 Ret. Diant. do Virabrequim
 A 278-R 64 x 80 x 9

R

Productos relacionados no incluidos en el juego. Los mismos pueden ser solicitados por separado.

Produtos relacionados não incluídos no jogo. Podem ser solicitados em separado.

Related products that were not included in the set but can be ordered separately.



BU-512
 Bulones para Culata de Cilindros
 Parafusos de Cabeçote



JT-115
 Juego Turbo
 Jogo Turbo



JAE-441-09 - 960708530084
 Juego Escape
 Jogo Escapamento

Juego Completo de Reparación:

Jogo de Juntas do Motor / Full Set Gasket:

Semi-Juego de Reparación:

Semi-Jogo de Juntas / Semi-Set Gasket:

SJ-272

R

Juego de Descarbonización:

Jogo de Juntas Superior / Head Set Gasket:

JD-174-ST

R

JUNTA CULATA DE CILINDROS

Junta de cabeçote
Cylinder Head gasket

TC-628 1M	∅ 92.00mm	± 1.37mm	± de 0,50 a 0,60mm
TC-628 2M	∅ 92.00mm	± 1.48mm	± de 0,61 a 0,70mm
TC-628 3M	∅ 92.00mm	± 1.59mm	± de 0,71 a 0,80mm
TC-628 4M	∅ 92.00mm	± 1.70mm	± de 0,80mm a ...
TC-793 1M	∅ 94.00mm	± 1.37mm	± de 0,50 a 0,60mm
TC-793 2M	∅ 94.00mm	± 1.48mm	± de 0,61 a 0,70mm
TC-793 3M	∅ 94.00mm	± 1.59mm	± de 0,71 a 0,80mm
TC-793 4M	∅ 94.00mm	± 1.70mm	± de 0,80mm a ...

DESCRIPCIÓN / Descrição / Description

DIESEL

FORD: Ranger TDI 95/... - Ranger TD BR 2000-02/...
GM CHEVROLET: Blazer TDI - S10 TDI 1995/...
MERCEDES BENZ: Sprinter TDI 1997/...
ROVER: Range Rover - Defender TDI 90/...
Discovery

MOTOR / Engine	CM ³	HP	∅ PISTON
200 - 300 TDI	2495	107/112	90.50
	2507	95	90.70
POWER STROKE	2758	135	93.00

ILLINOIS

MAXION

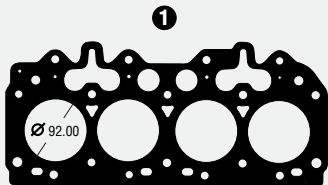

TC-628-20 1M TC-628-MG 1M - ERR5261/1
TC-628-20 2M TC-628-MG 2M - ERR5261/2
TC-628-20 3M TC-628-MG 3M - ERR5261/3
TC-628-20 4M TC-628-MG 4M
Junta Culata de Cilindros/Junta Cabeçote

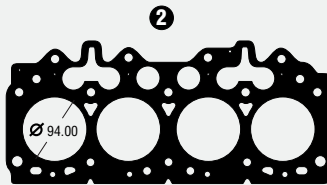

TC-793-20 1M TC-793-MG 1M
TC-793-20 2M TC-793-MG 2M
TC-793-20 3M TC-793-MG 3M
TC-793-20 4M TC-793-MG 4M
Junta Culata de Cilindros/Junta Cabeçote

JD-174-ST

2728100
O'ring 23 x 3mm

2610600
Arandela 14 x 20 x 1,5mm
Arruela (Aluminio)

1167200 - ERR2026
Bomba vacío
Bomba vácuo

2618900
Arandela inyector
Arruela injetor
7,3 x 15,8 x 0,8mm (Cobre)



JAE-393-09 - ERR3785
Múltiple Admisión y Escape
Coletor Admissão e Escapamento

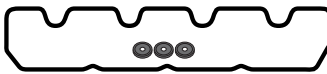

JVS-264-43 - ERR2409
Junta Tapa Válvula Superior c/arandelas
Junta Tampa Válvula Superior c/arruelas

1191800 - ERR2027
Bomba vacío
Bomba vácuo

1166700 - ERR3490
Carcasa termostato
Carcaça termostato

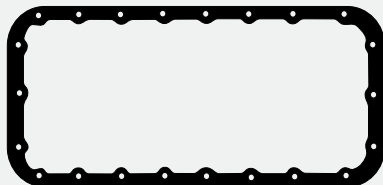

JC-317-26 - 70490300
Junta Cártér
Junta Carter

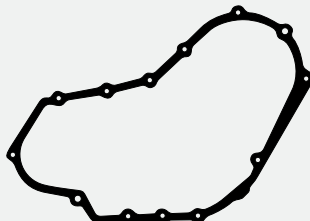

1167700 - ERR4120
Tapa distribución
Tampa distribuiçao

2726700
O'ring 37 x 4mm

RT-611Vit
Juego Ret. Guía de Vál.
Jogo Retentor da Haste de Válvulas

1167100 - ERR1653
Caño aceite
Tubo óleo

RT-9288Vit
Retén Árbol de Levas
Ret. Eixo Comando de Válv.
Lz-R 47,00 x 62,00 x 8,80

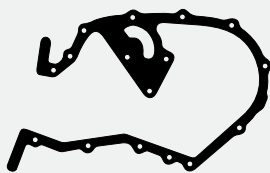

1167600 - ERR4860
Placa distribución
Placa distribuiçao

1167000 - ERR2023
Bomba inyectora
Bomba injetora

1166400 - ERR3283
Filtro aceite
Filtro óleo

1166500 - ERR3284
Bomba de agua
Bomba d'agua

2728200
Arandela 67 x 74 x 3mm
Arruela (Silicona/Silicone)

1167300 - ERR2378
Placa bomba de agua
Placa bomba de água

2743300 - ERR0913B
Lateral bancada
Lateral virabrequim

1167400 - ERR2028
Bomba de combustible
Bomba de combustivel

RT-9241Vit
Retén Distribución
Retentor Dianteiro do Virabrequim
A 145 58,00 x 74,00 x 8,00

1166600 - ERR4861
Junta porta retén trasero
Junta porta retentor traseiro

1167500 - ERR1561
Inspección frente distribución
Inspeçao frente distribuiçao

2625400 - Juego Arandelas Metálicas/Jogo Arruelas Metálicas

Gráfico	Descripción/Descrição	Cant./Quant.
	Ar./Arruela 19,5x27x1,5mm Alum.	1
	Arandela/Arruela 9,4x18x1mm Fibra	1
	Aran./Arruela 9,4x18x0,8mm Cobre	3
	Arand./Arruela 12x17x1,5mm Cobre	6
	Arandela/Arruela 6x10x1mm Cobre	8

RT-9203Pol
Retén Auxiliar
Retentor Auxiliar
Lx-R 57,00 x 71,00 x 9,50

Productos relacionados no incluidos en el juego. Los mismos pueden ser solicitados por separado.

Produtos relacionados não incluídos no jogo. Podem ser solicitados em separado.

Related products that were not included in the set but can be ordered separately.



BU-016 BU-239
Bul. p/Cul. Cilindros
Parafusos de Cabeçote



RT-2874Vit - ERR4179
Porta Retén Bancada
Flange Traseiro do Virabrequim



JT-110
Juego Turbo
Jogo Turbo



JC-317-15 70490300
Junta Cártér
Junta Carter



JT-122
Juego Turbo
Jogo Turbo

DESCRIPCIÓN / Descrição / Description

DIESEL

FORD: Ranger 3.0 16V 4x4
Full BR Intercooler 10/2007...

MOTOR / Engine	CM ³	HP	Ø PISTON
MAXION TD (SOCH)	2968	163	96.00
POWER STROKE			
NGD 16V			

Juego Completo de Reparación:

Jogo de Juntas do Motor / Full Set Gasket:

Semi-Juego de Reparación:

Semi-Jogo de Juntas / Semi-Set Gasket:

SJ-524

R

Juego de Descarbonización:

Jogo de Juntas Superior / Head Set Gasket:

JD-524-ST

R

JUNTA CULATA DE CILINDROS	TC-888 1M	TC-888 2M	TC-888 3M	TC-888 4M	Ø	Ø	Ø	Ø	Ø	Ø	Ø	Ø	
Junta de cabeçote	1M	2M	3M	4M	99.00mm	99.00mm	99.00mm	99.00mm	99.00mm	1.30mm	1.40mm	1.50mm	1.60mm
Cylinder Head gasket													

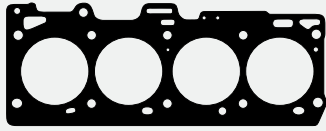

TC-888-20 1M TC-888-MG 1M - 70490792
TC-888-20 2M TC-888-MG 2M - 70490791
TC-888-20 3M TC-888-MG 3M - 70490815
TC-888-20 4M TC-888-MG 4M - 70490815
Junta Culata de Cilindros/Junta Cabeçote

JD-524-ST



2747600 - 70490704
Guarnición conexión entrada agua
Guarnição conexão entrada água



2747500 - 70490709
Guarn. tubo succión aceite
Guarnição tubo sucção óleo



2609400
Arandela
Arruela (Cobre)
7,5 x 15 x 2mm



JAE-518-A - 70490786
Juego Admisión
Jogo Admissão



JAE-517-E - 70490785
Juego Escape
Jogo Escapamento



2749800
O'ring 22 x 1,8mm



2749700
O'ring 10 x 1,5mm

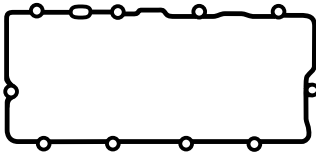

JVS-332-43 - 70490859
Junta Tapa Válvula Superior
Junta Tampa Válvula Superior



2746900 - 70490700
Juego adaptador inyectores
Jogo adaptador injetores



1098000
Junta brida
Junta flange



RT-892Vit
Juego Retenes Guía de Válvulas
Jogo Retentor da Haste de Válvulas



JC-317-26 - 70490300
Junta Cártel
Junta Carter

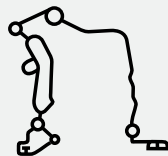

2747000 - 70490823
Placa distribución a block
Placa distribuição ao bloco

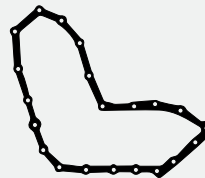

1097200
Tapa distribución
Tampa distribuição

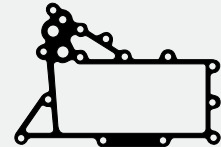

1185100 - 70490690
Enfriador aceite
Resfriador óleo



2747400 - 70590021
Anillo cierre tapa inyectora distribución
Anel fechamento tampa injetora distribuição



2747200 - 70490814
Bomba inyectora
Bomba injetora



2747100 - 70490708
Entrada agua a block
Entrada água ao bloco



2747300
Guarnición cierre
Guarnição fechamento



2750000
O'ring 43 x 3,4mm



2749900
O'ring 37,50 x 3mm



2630100
Arandela 6 x 17 x 1mm
Arruela (Fibra)



RT-2958Vit
Retén Distribución
Ret. Dianteiro do Virabrequim
60,40 x 79,35 x 9,50

Productos relacionados no incluidos en el juego. Los mismos pueden ser solicitados por separado.

Produtos relacionados não incluídos no jogo. Podem ser solicitados em separado.

Related products that were not included in the set but can be ordered separately.



BU-189
Bulones para Culata de Cilindros
Parafusos de Cabeçote



JC-317-15
70490300
Junta Cártel
Junta Carter



RT-2874Vit
Porta Retén Bancada
Flange Traseiro do Virabrequim



2776500
Bomba de agua
Bomba de água

Juego Completo de Reparación:

Jogo de Juntas do Motor / Full Set Gasket:

Semi-Juego de Reparación:

Semi-Jogo de Juntas / Semi-Set Gasket:

Juego de Descarbonización:

Jogo de Juntas Superior / Head Set Gasket:

JUNTA CULATA DE CILINDROS	TC-888 1M	Ø 99.00mm	± 1.30mm	± de 0,58 a 0,69mm
Junta de cabeçote	TC-888 2M	Ø 99.00mm	± 1.40mm	± de 0,70 a 0,79mm
Cylinder Head gasket	TC-888 3M	Ø 99.00mm	± 1.50mm	± de 0,80 a 0,89mm
	TC-888 4M	Ø 99.00mm	± 1.60mm	± de 0,90 a 0,99mm

DESCRIPCIÓN / Descrição / Description

DIESEL

FORD: Ranger 3.0 16V 4x4
Full BR Intercooler 2005... 10/2007

MOTOR / Engine	CM ³	HP	Ø PISTON
MAXION TD (SOCH)	2968	163	96.00
POWER STROKE			
NGD 16V			

ILLINOIS

MAXION

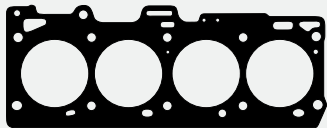

TC-888-20 1M **TC-888-MG 1M** - 70490792
TC-888-20 2M **TC-888-MG 2M** - 70490791
TC-888-20 3M **TC-888-MG 3M** - 70490815
TC-888-20 4M **TC-888-MG 4M** - 70490815
 Junta Culata de Cilindros/Junta Cabeçote

JD-525-ST



2747600 - 70490704
Guarnición conexión entrada agua
Guarnição conexão entrada água



2747500 - 70490709
Guarn. tubo succión aceite
Guarnição tubo sucção óleo



2609400
Arandela 7,5 x 15 x 2mm
Arruela(Cobre)



JAE-518-A - 70490786
Juego Admisión
Jogo Admissão



JAE-517-E - 70490785
Juego Escape
Jogo Escapamento



2749800
O'ring 22 x 1,8mm



2749700
O'ring 10 x 1,5mm

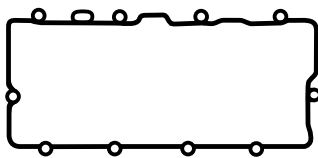

JVS-331-43 - 70490701
Junta Tapa Válvula Superior
Junta Tampa Válvula Superior



2746900 - 70490700
Juego adaptador inyectores
Jogo adaptador injetores



1098000
Junta brida
Junta flange



RT-892Vit
Juego Retenes Guía de Válvulas
Jogo Retentor da Haste de Válvulas

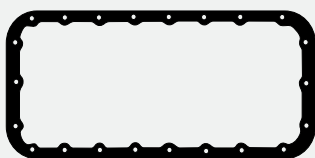

JC-317-26 - 70490300
Junta Cártar
Junta Carter

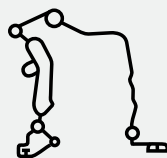

2747000 - 70490823
Placa distribución a block
Placa distribuição ao bloco

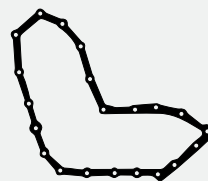

1097200
Tapa distribución
Tampa distribuição

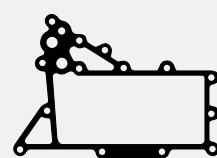

1185100 - 70490690
Enfriador aceite
Resfriador óleo



2747400 - 70590021
Anillo cierre tapa inyectora distribución
Anel fechamento tampa injetora distribuição



2747200 - 70490814
Bomba inyectora
Bomba injetora



2747100 - 70490708
Entrada agua a block
Entrada água ao bloco



2747300
Guarnición cierre
Guarnição fechamento



2750000
O'ring 43 x 3,4mm



2749900
O'ring 37,50 x 3mm



2630100
Arandela 6 x 17 x 1mm
Arruela (Fibra)



RT-2958Vit
Retén Distribución
Ret. Dianteiro do Virabrequim
60,40 x 79,35 x 9,50

Productos relacionados no incluidos en el juego. Los mismos pueden ser solicitados por separado.

Produtos relacionados não incluídos no jogo. Podem ser solicitados em separado.

Related products that were not included in the set but can be ordered separately.



BU-189
Bulones para Culata de Cilindros
Parafusos de Cabeçote



JC-317-15
70490300
Junta Cártar
Junta Carter



RT-2874Vit
Porta Ret. Bancada
Flange Traseiro do Virabrequim



2776500
Bomba de agua
Bomba de água

DESCRIPCIÓN / Descrição / Description DIESEL			
MAXION: S4/S4T/ST4 PLUS			
CHEVROLET: GM D20 - D40 - Pick Up D20			
GMC 6150/6100 - F1000			
MOTOR / Engine	CM ³	HP	Ø PISTON
Maxion S4	3990	102	100.00

Juego Completo de Reparación:

Jogo de Juntas do Motor / Full Set Gasket:

JR-281-20



Semi-Juego de Reparación:

Semi-Jogo de Juntas / Semi-Set Gasket:

SJ-281



Juego de Descarbonización:

Jogo de Juntas Superior / Head Set Gasket:

JD-281-20



JUNTA CULATA DE CILINDROS	TC-450-20	Ø 104.00mm	1.65mm	1.65mm	1.65mm
Junta de cabeçote					
Cylinder Head gasket					

JD-281-20

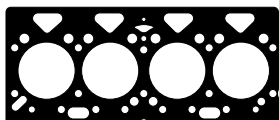

TC-450-20 - 70490195
3681E016/18/36812338
Junta Culata de Cilindros
Junta Cabeçote

2705300
Arandela 7,2 x 11 x 6mm
Arruela (Sintético)



1190800 - 70490257
Codo motor a múltiple
Cotovelo motor ao coletor

2705100
O'ring 18,77 x 1,78mm



2705200
Arandela 41,5 x 47,5 x 7mm
Arruela (Sintético)

2742500
O'ring 15,6 x 1,78mm



1108200 - 36853514
Cuerpo salida agua
Corpo saída água



JAE-335 - 3688C001/002/007
Múltiple Admisión y Escape
Coletor Admissão e Escapamento



1190400 - 36862538
70490256
Adaptador filtro de aceite
Adaptador filtro de óleo

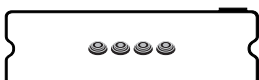

JVS-298-43 - 70490258
Junta Tapa Válvula Sup. c/arrandelas
Junta Tampa Válvula Sup. c/arruelas



2705500
Arandela 73 x 83,5 x 9mm
Arruela (Sintético)



1190700 - 70490254
Conexión bomba de agua a term.
Conexão bomba água ao termostato



RT-608PoI
Jgo. Ret. Guía de Vál
Jogo Retenedor da
Haste de Válvulas

2612100 - Juego Arandelas Metálicas/Jogo Arruelas Metálicas

Gráfico	Descripción/Descrição	Cant./Quant.
	Ar./Arruela 22,5x29x2mm Aluminio	1
	Aran./Arruela 20x28x1mm Aluminio	1
	Arand./Arruela 18x22x1,5mm Cobre	3
	Ar./Arruela 15x21x1,5mm Aluminio	4
	Aran./Arruela 14x17x2mm Aluminio	1
	Ar./Arruela 10x15x1,5mm Aluminio	3
	Arand./Arruela 8x12x1mm Cobre	2
	Arand./Arruela 7,5x15x2mm Cobre	4
	Arand./Arruela 6x8x1mm Cobre	8



JT-102-02 - 2137909/36885008
Base Turbo
Base Turbo



1107800 - 36832122
Bomba de aceite
Bomba de óleo



1190300 - 36865511
Adaptador bomba de vacío
Adaptador bomba de vácuo



1196500 - 70490255
Cuerpo trasero bomba de agua
Corpo traseiro bomba de água



JC-334-30 - 70490178
Junta Cáster
Junta Carter

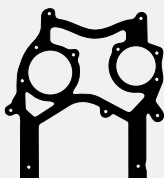

1107600 - 36814123/27/37
Caja distribución
Caixa distribuição



1038200 - 36817157
Porta retén trasero
Porta retenedor traseiro



1190900 - 70490259
Tapa distribución
Tampa distribuição



1107400 - 0490685/99/0490773
Bomba de combustible
Bomba de combustível



1190500 - 70490145
Cuerpo trasero bomba de agua
Corpo traseiro bomba de água



1108100 - 36851409
Tapa trasera
Tampa traseira



1016800 - 36834143
Bomba inyectora
Bomba injetora



1190600 - 70490144
Bomba de agua a block
Bomba de água ao bloco



1108000 - 36851113
Bomba alimentación
Bomba alimentação



RT-6823Vit
Retén Bancada
Retenedor Traseiro do Virabrequim
Lx-R 133,35 x 158,75 x 12,50



RT-8070PoI
Retén Distribución
Ret. Dianteiro do Virabrequim
Mz-H 60,32 x 79,35 x 11,00

Productos relacionados no incluidos en el juego. Los mismos pueden ser solicitados por separado.

Produtos relacionados não incluídos no jogo. Podem ser solicitados em separado.
Related products that were not included in the set but can be ordered separately.



BU-172
Bulones para Culata de Cilindros
Parafusos de Cabeçote



JC-334-26 - 70490178
Junta Cáster
Junta Carter (1,5mm)



JT-116
Juego Turbo
Jogo Turbo

Juego Completo de Reparación:

Jogo de Juntas do Motor / Full Set Gasket:

JR-513-15

DESCRIPCIÓN / Descrição / Description

MAZDA: 323 - Familia - GLC - Laser turbo
1980/... (E30199100/E58099100)**Semi-Juego de Reparación:**

Semi-Jogo de Juntas / Semi-Set Gasket:

SJ-513**Juego de Descarbonización:**

Jogo de Juntas Superior / Head Set Gasket:

JD-513-15

JUNTA CULATA DE CILINDROS	TC-471-15	∅ 79.00mm	1.60mm	↑ ↓
Junta de cabeçote				↑ ↓
Cylinder Head gasket				↑ ↓

MOTOR / Engine	CM ³	HP	∅ PISTON
E3	1296	60	77.00
E5-E5T	1490	85	77.00

ILLINOIS

MAZDA

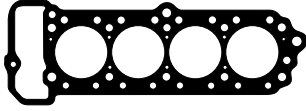
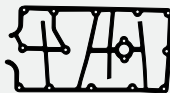
JD-513-15**TC-471-15** - E30110271
E50110271
Junta Culata de Cilindros
Junta Cabeçote**JSA-290** - E30110271/E50110271
Salida Escape
Saída Escapamento**1093200**
Interior carburador
Interior carburador**JAE-504-A**
Junta Admisión
Junta Admissão**JAE-503-E**
Junta Escape
Junta Escapamento**1093400**
Base carburador
Base carburador**JVS-328-43** - E30110235/50/3077
Junta Tapa Válvula Superior
Junta Tampa Válvula Superior**1093500**
Bomba de agua
Bomba de água**1093100**
Cuba nafta
Cuba gasolina**JC-352-30**
Junta Cáster
Junta Carter**1093600**
Base termostato
Base termostato**RT-542Pol**
Jgo. Retenes Guía de Vál.
Jogo Retentor da Haste de Válvulas**1093300**
Brida aceite
Flange óleo**1093800**
Distribución derecha
Distribuição direita**1094000**
Junta placa**1093000**
Bomba de nafta
Bomba de gasolina**1093900**
Distribución izquierda
Distribuição esquerda**1093700**
Tapa inspección
Tampa inspeção**RT-8220Pol**
Retén Bancada
Retentor Traseiro do Virabrequim
Lx-R 70,00 x 88,00 x 12,00**RT-8573Pol**
Retén Distribución
Retentor Dianteiro do Virabrequim
A 156-R 40,00 x 55,00 x 8,00

Productos relacionados no incluidos en el juego. Los mismos pueden ser solicitados por separado.

Produtos relacionados não incluídos no jogo. Podem ser solicitados em separado.

Related products that were not included in the set but can be ordered separately.



DESCRIPCIÓN / Descrição / Description

DIESEL

MAZDA: B2200D 1987/... E2200D 1991/...
(8AZ610271A)

MOTOR / Engine	CM ³	HP	Ø PISTON
R2	2184	64	86.00

Juego Completo de Reparación:

Jogo de Juntas do Motor / Full Set Gasket:

JR-676-07

R

Semi-Juego de Reparación:

Semi-Jogo de Juntas / Semi-Set Gasket:

Juego de Descarbonización:

Jogo de Juntas Superior / Head Set Gasket:

JUNTA CULATA DE CILINDROS

Junta de cabeçote

Cylinder Head gasket

TC-677-07

Ø 87.50mm

1.50mm

1.50mm

1.50mm

1.50mm

1.50mm

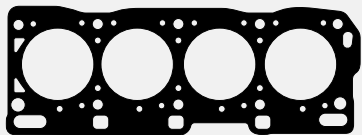

TC-677-07 - R20210271F/R2B610271B
Junta Culata de Cilindros
Junta Cabeçote



Salida Escape
Saída Escapamento



Bomba de agua
Bomba de água



Junta Admisión
Junta Admissão



Junta Escape
Junta Escapamento



Junta

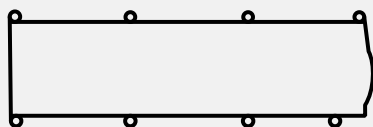

Junta Tapa Válvula Superior
Junta Tampa Válvula Superior



Junta



Junta

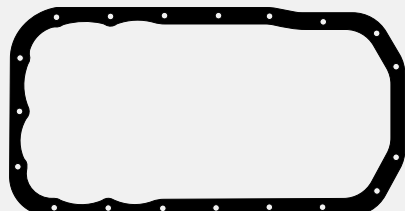

Junta Carter
Junta Cárter



Distribución
Distribuição



Junta



Junta



Retén Bancada
Retentor Traseiro do Virabrequim



Retén Distribución
Retentor Dianteiro do Virabrequim



Retén Árbol de Leva
Retentor do Eixo Comando de Válvulas



Juego Retenes Guía de Válvulas
Jogo Retentor da Haste de Válvulas

R

Productos relacionados no incluidos en el juego. Los mismos pueden ser solicitados por separado.

Produtos relacionados não incluídos no jogo. Podem ser solicitados em separado.

Related products that were not included in the set but can be ordered separately.

Juego Completo de Reparación:

Jogo de Juntas do Motor / Full Set Gasket:

JR-675-11**R**

DESCRIPCIÓN / Descrição / Description

DIESEL**MAZDA:** B2500 2002/... MPV TDI 1996/...
Proceed (8ASX10271A)**Semi-Juego de Reparación:**

Semi-Jogo de Juntas / Semi-Set Gasket:

Juego de Descarbonización:

Jogo de Juntas Superior / Head Set Gasket:

JUNTA CULATA DE CILINDROS	TC-813-20	Ø 95.50mm	1.40mm	1.40mm
	TC-813-MG	Ø 95.50mm	1.40mm	
Junta de cabeçote				
Cylinder Head gasket				

MOTOR / Engine	CM ³	HP	Ø PISTON
WL	2500	78	93.00
WLT	2500	84	93.00

ILLINOIS

MAZDA



TC-813 - 4330744/WL5110272
Junta Culata de Cilindros
Junta Cabeçote



Bomba de agua
Bomba de água



Junta



Junta Admisión
Junta Admissão



Junta Escape
Junta Escapamento

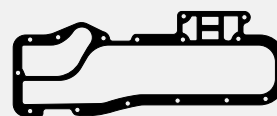

Junta

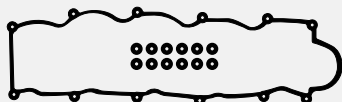

Junta Tapa Válvula
Junta Tampa Válvula



Junta



Junta



Retén Bancada
Retenedor Traseiro do Virabrequim



Retén Árbol de Leva
Retenedor do Eixo Comando de Válvulas



Juego Retenes Guía de Válvulas
Jogo Retedor da Haste de Válvulas



Retén Distribución
Retenedor Dianteiro do Virabrequim



Retén Auxiliar
Retenedor Auxiliar

Productos relacionados no incluidos en el juego. Los mismos pueden ser solicitados por separado.

Produtos relacionados não incluídos no jogo. Podem ser solicitados em separado.

Related products that were not included in the set but can be ordered separately.

DESCRIPCIÓN / Descrição / Description

MITSUBISHI: Lancer - Colt - Mirage 1983/88
(MD997113)

MOTOR / Engine	CM ³	HP	Ø PISTON
G15B	1468	70	75.50
4G15	1468	69	75.50

Juego Completo de Reparación:

Jogo de Juntas do Motor / Full Set Gasket:

JR-670-07



Semi-Juego de Reparación:

Semi-Jogo de Juntas / Semi-Set Gasket:

Juego de Descarbonización:

Jogo de Juntas Superior / Head Set Gasket:

JUNTA CULATA DE CILINDROS	TC-832-07	Ø 76.90mm	1.50mm	↑ ↓
Junta de cabeçote				↑ ↓
Cylinder Head gasket				↑ ↓

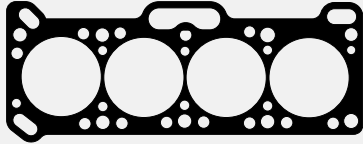

TC-832-07 - MD016163
Junta Culata de Cilindros
Junta Cabeçote



Salida Escape
Saída Escapamento



Arandela goma
Arruela Borracha

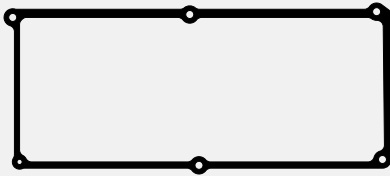

Tapa de Válvula
Tampa de Válvula



Junta Admisión
Junta Admissão



Junta Escape
Junta Escapamento

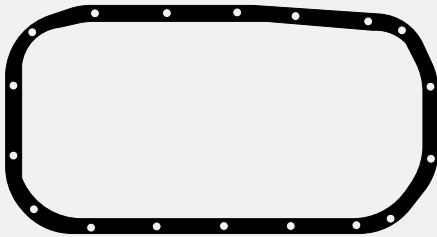

Junta Carter
Junta Cáter

Retén Bancada
Retentor Traseiro do
Virabrequim

Juego Retenes Guía de Válvulas
Jogo Retentor da Haste de Válvulas

Retén Distribución
Retentor Dianteiro do
Virabrequim

Retén Árbol de Leva
Retentor do Eixo Comando
de Válvulas

Productos relacionados no incluidos en el juego. Los mismos pueden ser solicitados por separado.

Produtos relacionados não incluídos no jogo. Podem ser solicitados em separado.

Related products that were not included in the set but can be ordered separately.

Juego Completo de Reparación:

Jogo de Juntas do Motor / Full Set Gasket:

JR-674-07

DESCRIPCIÓN / Descrição / Description

MITSUBISHI: Galant - L200 - L300 - Colt
Mirage - Lancer 1981/... (MD997156)

MOTOR / Engine	CM ³	HP	Ø PISTON
4G32B	1597	65	77.00

ILLINOIS

MITSUBISHI

Juego de Descarbonización:

Jogo de Juntas Superior / Head Set Gasket:

JUNTA CULATA DE CILINDROS	TC-672-07	Ø 78.00mm	1.50mm	mm	mm	mm	mm	mm	mm
Junta de cabeçote									
Cylinder Head gasket									

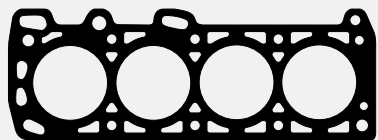
**TC-672-07** - MD010313/MD012886/MD034094
Junta Culata de Cilindros
Junta Cabeçote

Junta

Bomba de agua
Bomba d'águaJunta Admisión
Junta AdmissãoJunta Escape
Junta Escapamento

Junta

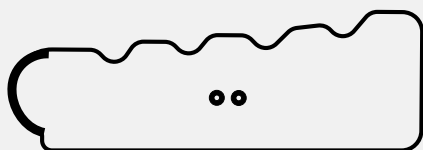
Tapa de Válvula
Tampa de Valvula

Junta

Distribución
DistribuiçãoJunta Carter
Junta Cârtter

Junta



Junta



Junta

**R**
Juego Retenes Guía de Válvulas
Jogo Retedor da Haste de VálvulasRetén Bancada
Retentor Traseiro do
VirabrequimRetén Auxiliar
Retentor AuxiliarRetén Distribución
Retentor Dianteiro do
VirabrequimRetén Árbol de Leva
Retentor do Eixo Comando
de Válvulas

Productos relacionados no incluidos en el juego. Los mismos pueden ser solicitados por separado.

Produtos relacionados não incluídos no jogo. Podem ser solicitados em separado.

Related products that were not included in the set but can be ordered separately.

DESCRIPCIÓN / Descrição / Description

MITSUBISHI: Pajero IO 1998/...
Pajero TR4 Flex 2002/... - Montero IO 2001/...

MOTOR / Engine	CM ³	HP	Ø PISTON
4G93 16V	1799	92	81.00
4G94 16V	1999	131/136	81.50

Juego Completo de Reparación:

Jogo de Juntas do Motor / Full Set Gasket:

JR-745-07

R

Semi-Juego de Reparación:

Semi-Jogo de Juntas / Semi-Set Gasket:

Juego de Descarbonización:

Jogo de Juntas Superior / Head Set Gasket:

JUNTA CULATA DE CILINDROS	TC-678-07	Ø 82.00mm	1.60mm	↑ ↓
Junta de cabeçote	TC-678-11	Ø 82.00mm	1.20mm	↑ ↓
Cylinder Head gasket				↑ ↓

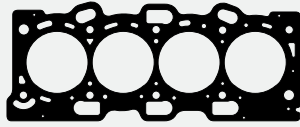

TC-678-07 - MD365937/MD367277
Junta Culata de Cilindros
Junta Cabeçote



Junta



Junta



Junta Admisión
Junta Admissão



Junta Escape
Junta Escapamento



Arandela goma
Arruela Borracha

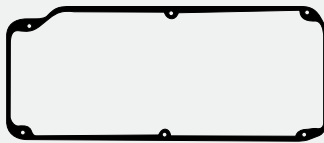

Tapa de Válvula
Tampa de Válvula



Retén Bancada
Retentor Traseiro do
Virabrequim



Juego Retenes Guía de Válvulas
Jogo Retentor da Haste
de Válvulas



Retén Distribución
Retentor Dianteiro
do Virabrequim



Retén Árbol de Leva
Retentor do Eixo Comando
de Válvulas

Productos relacionados no incluidos en el juego. Los mismos pueden ser solicitados por separado.

Produtos relacionados não incluídos no jogo. Podem ser solicitados em separado.

Related products that were not included in the set but can be ordered separately.

Juego Completo de Reparación:

Jogo de Juntas do Motor / Full Set Gasket:

JR-669-07**Semi-Juego de Reparación:**

Semi-Jogo de Juntas / Semi-Set Gasket:

Juego de Descarbonización:

Jogo de Juntas Superior / Head Set Gasket:

JUNTA CULATA DE CILINDROS	TC-473-07	∅ 86.70mm	1.55mm	↑ ↓
Junta de cabeçote				↑ ↓
Cylinder Head gasket				↑ ↓

DESCRIPCIÓN / Descrição / Description

MITSUBISHI: Eclipse I 1989/95
Galant 1993/95 (MD971619/20)

MOTOR / Engine	CM ³	HP	∅ PISTON
4G63	1997	116	85.00
4G63T	1997	182	85.00

ILLINOIS

MITSUBISHI

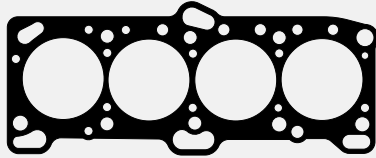

TC-473-07 - MD113173/183808/MD040533
Junta Culata de Cilindros
Junta Cabeçote



Bomba de agua
Bomba de água



Distribución
Distribuição



Junta Admisión
Junta Admissão



Junta Escape
Junta Escapamento



Junta

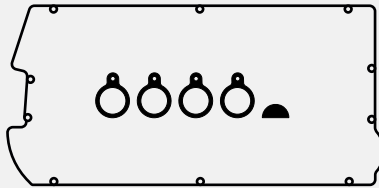

Tapa de Válvula
Tampa de Válvula



Junta



Junta

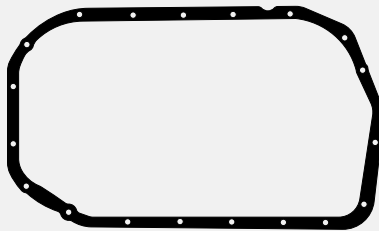

Junta Carter
Junta Cártier



Distribución
Distribuição



Bomba de agua
Bomba de água



Chupador de aceite
Pescador óleo



Junta



Bomba combustible
Bomba combustível

Productos relacionados no incluidos en el juego. Los mismos pueden ser solicitados por separado.

Produtos relacionados não incluídos no jogo. Podem ser solicitados em separado.

Related products that were not included in the set but can be ordered separately.

DESCRIPCIÓN / Descrição / Description **DIESEL**

MITSUBISHI: Galant 1992/96 - Lancer 1992/03
Space Wagon 1992/98 (MD971654/655)

MOTOR / Engine	CM ³	HP	Ø PISTON
4D68	1998	68	82.70
4DG8T	1998	82	82.70

Juego Completo de Reparación:

Jogo de Juntas do Motor / Full Set Gasket:

JR-673-07

R

Semi-Juego de Reparación:

Semi-Jogo de Juntas / Semi-Set Gasket:

Juego de Descarbonización:

Jogo de Juntas Superior / Head Set Gasket:

JUNTA CULATA DE CILINDROS	TC-681-07	Ø 84.00mm	1.50mm	↑ ↓
Junta de cabeçote				↑ ↓
Cylinder Head gasket				↑ ↓

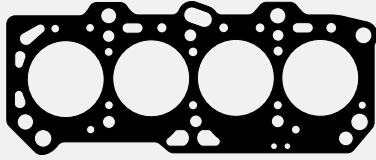

TC-681-07 - MD301580
Junta Culata de Cilindros
Junta Cabeçote



Junta Escape
Junta Escapamento



Junta Admisión
Junta Admissão



Bomba de agua
Bomba d'água

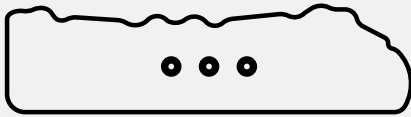

Tapa de Válvula
Tampa de Válvula



Junta

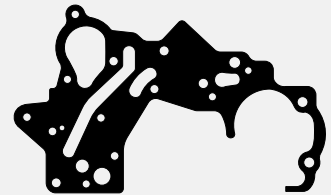

Distribución
Distribuição



Junta



Junta



Junta



Junta



Retén Bancada
Retenedor Traseiro do
Virabrequim



Retén Distribución
Retenedor Dianteiro do
Virabrequim



Retén Árbol de Leva
Retenedor do Eixo Comando
de Válvulas



Juego Retenes Guía de Válvulas
Jogo Retenedor da Haste de Válvulas



Retén Auxiliar
Retenedor Auxiliar



Retén Auxiliar
Retenedor Auxiliar



Retén Auxiliar
Retenedor Auxiliar

Productos relacionados no incluidos en el juego. Los mismos pueden ser solicitados por separado.

Produtos relacionados não incluídos no jogo. Podem ser solicitados em separado.

Related products that were not included in the set but can be ordered separately.

Juego Completo de Reparación:

Jogo de Juntas do Motor / Full Set Gasket:

Semi-Juego de Reparación:

Semi-Jogo de Juntas / Semi-Set Gasket:

SJ-476



Juego de Descarbonización:

Jogo de Juntas Superior / Head Set Gasket:

JD-487-ST



JUNTA CULATA DE CILINDROS	TC-441 2M	Ø 92.20mm	1.40mm	de 0,55 a 0,62mm
Junta de cabeçote	TC-441 3M	Ø 92.20mm	1.50mm	de 0,63 a 0,74mm
Cylinder Head gasket	TC-441 4M	Ø 92.20mm	1.60mm	de 0,75mm ...
	TC-441 5M	Ø 92.20mm	1.70mm	
	TC-441 6M	Ø 92.20mm	1.80mm	
	TC-441 7M	Ø 92.20mm	2.10mm	

DESCRIPCIÓN / Descrição / Description

DIESEL

MITSUBISHI: L200 1987/... Canter T35 1987/98
Pajero Montero 1986/..
CHRYSLER: Pick Up Power Ram 50 TD 1983/85
HYUNDAI: H100-H1 D/TD 1986/...- Galloper
Liberto 1998/...
FORD: Bronco II TD - Ranger 2WD 85/... (MD972160)

MOTOR / Engine	CM ³	HP	Ø PISTON
4D55T	2346	67/84	91.10
4D56	2476	70/84	91.10
D4BA - X/D4BH	2476	75/100	91.10
D4BB	2607	85	91.10

ILLINOIS

MITSUBISHI

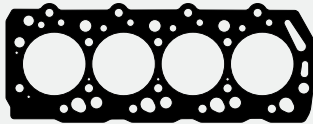

TC-441-20 2M TC-441-MG 2M
TC-441-20 3M TC-441-MG 3M
TC-441-20 4M TC-441-MG 4M
TC-441-20 5M TC-441-MG 5M
TC-441-20 6M TC-441-MG 6M
TC-441-20 7M TC-441-MG 7M

MD050545/088581/112531

Junta Culata de Cilindros/Junta Cabeçote

JD-487-ST



1102600
Tapa bomba de agua
Tampa bomba de água



1111000
Filtro de aceite
Filtro de óleo



1133100
Termostato
Termostato



1135600
Chupador de aceite
Pescador óleo



1133200
Tapa termostato
Tampa termostato



RT-550Pol
Juego Retenes Guía de Válvulas
Jgo. Retenedor da Haste de Válvulas



RT-8130Vit
Retén Árbol de Levas
Ret. do Eixo Comando de Válvulas
Lx-R 35,00 x 50,00 x 8,00

2769000 - Juego Arandelas de Goma/Jogo Arruelas de Borracha

Gráfico	Descripción/Descrição	Cant./Quant.
	Medialuna Goma/Meia lua Borracha	1
	O'ring 25x3,5mm	1
	O'ring 25x2,5mm	1
	O'ring 8x1,78mm	2
	O'ring 4,5x1,78mm	1



JAE-597
Múltiple Admisión y Escape
Coletor Admissão e Escapamento



JVS-388-43
Junta Tapa de Válvula
Junta Tampa de Válvula



JC-400-34
Junta Cáster
Junta Carter



1130300
Porta retén trasero
Porta retentor traseiro



1110300
Retorno aceite
Retorno óleo



1109600
Varilla aceite
Varela óleo



1122200
Base bomba de agua
Base bomba de água



1103000
Base bomba de agua
Base bomba de água



1102400
Tapa distribución
Tampa distribuição



2769800
Bomba de aceite
Bomba de óleo

2638100 - Juego Arandelas Metálicas/Jogo Arruelas Metálicas

Gráfico	Descripción/Descrição	Cant./Quant.
	Aran./Arruela 12x18x1mm Cobre	12
	Ar./Arruela 14x18x1,5mm Aluminio	1
	Aran./Arruela 18x23x1mm Aluminio	1
	Aran./Arruela 8x12x1mm Aluminio	4



RT-8311Pol
Retén Bancada
Retenedor Traseiro do Virabrequim
Lx-R 80,00 x 96,00 x 9,00



RT-8129Pol
Retén Distribución
Retenedor Dianteiro do Virabrequim
Lx-R 44,20 x 60,00 x 7,00



RT-9501Pol
Retén Distribución
Retenedor Dianteiro do Virabrequim
Lx-R-H 25,00 x 35,00 x 6,00



RT-9500Pol
Retén Distribución
Retenedor Dianteiro do Virabrequim
Lx-R-H 17,00 x 28,00 x 7,00

Productos relacionados no incluidos en el juego. Los mismos pueden ser solicitados por separado.

Produtos relacionados não incluídos no jogo. Podem ser solicitados em separado.

Related products that were not included in the set but can be ordered separately.



BU-510
Bulones para
Culata de Cilindros
Parafusos de Cabeçote



JAE-595
Múltiple Admisión y Escape
Coletor Admissão e
Escapamento (Metálico)

DESCRIPCIÓN / Descrição / Description **DIESEL**

MITSUBISHI: L200 TD 2003/... (1000A407)

MOTOR / Engine CM³ HP Ø PISTON

4D56T 2470 136 91.00

Juego Completo de Reparación:

Jogo de Juntas do Motor / Full Set Gasket:

JR-728-07

R

Semi-Juego de Reparación:

Semi-Jogo de Juntas / Semi-Set Gasket:

Juego de Descarbonización:

Jogo de Juntas Superior / Head Set Gasket:

JUNTA CULATA DE CILINDROS	TC-326-07	Ø 92.20mm	1.60mm	↑ ↓
Junta de cabeçote				↑ ↓
Cylinder Head gasket				↑ ↓

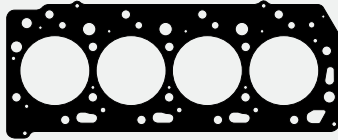

TC-326-07 - 1005A205/06
Junta Culata de Cilindros
Junta Cabeçote



Filtro de aceite
Filtro de óleo



Salida escape
Saída escapamento



Junta Admisión
Junta Admissão



Junta Escape
Junta Escapamento



Junta

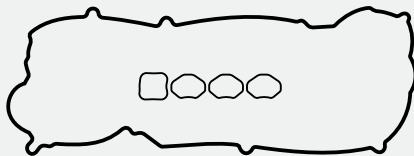

JVS-394-43
Junta Tapa Válvula Superior
Junta Tampa Válvula Superior



Junta Escape
Junta Escapamento



Junta



Junta



Base bomba de agua
Base bomba de água



Tapa distribución
Tampa distribuição



Bomba de agua
Bomba d'água



Brida
Flange



Chupador aceite
Pescador óleo



Retén Retenitor
25,00 x 35,00 x 6,00



Retén Retenitor
17,00 x 28,00 x 7,00



Juego Retenes Guía de Válvulas
Jogo Retenitor da Haste de Válvulas



Retén Bancada
Retenitor Traseiro do Virabrequim
44,00 x 60,00 x 7,00



Retén Distribución
Retenitor Dianteiro do Virabrequim
91,00 x 107,00 x 8,00

Productos relacionados no incluidos en el juego. Los mismos pueden ser solicitados por separado.

Produtos relacionados não incluídos no jogo. Podem ser solicitados em separado.

Related products that were not included in the set but can be ordered separately.

Juego Completo de Reparación:

Jogo de Juntas do Motor / Full Set Gasket:

JR-672-07

DESCRIPCIÓN / Descrição / Description

DIESEL**MITSUBISHI:** Montero - Pajero .../2002

Nativa TD 1999/...

(ME995738/ME994155/ME995497)

MOTOR / Engine

CM³

HP

Ø PISTON

4M40

2835

94

95.00

4M40T

2835

109

95.00

ILLINOIS

MITSUBISHI**Juego de Descarbonización:**

Jogo de Juntas Superior / Head Set Gasket:

JUNTA CULATA DE CILINDROS	TC-916-20 2M	∅ 96.00mm	1.35mm	↑ ↓
	TC-916-20 3M	∅ 96.00mm	1.40mm	↑ ↓
Junta de cabeçote	TC-916-20 4M	∅ 96.00mm	1.45mm	↑ ↓
Cylinder Head gasket				↑ ↓

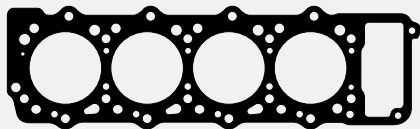

TC-916 - ME200751
Junta Culata de Cilindros
Junta Cabeçote



Junta



Junta



Junta



Juego Escape
Jogo Escapamento



Juego Admisión
Jogo Admissão



Salida Escape
Saída Escapamento



Junta



Tapa de Válvula
Tampa de Válvula



Junta



Bomba de agua
Bomba d'água



Bomba de agua
Bomba d'água

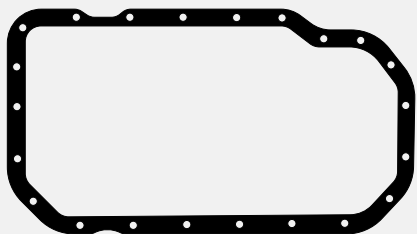

Junta Carter
Junta Cártter



Junta



Junta

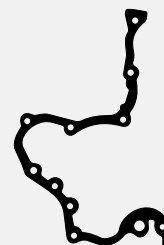

Distribución
Distribuição



Junta



Junta



Juego Retenes Guía de Válvulas
Jogo Retentor da Haste de Válvulas



Retén Bancada
Retentor Traseiro do Virabrequim



Retén Distribución
Retentor Dianteiro do Virabrequim



Productos relacionados no incluidos en el juego. Los mismos pueden ser solicitados por separado.

Produtos relacionados não incluídos no jogo. Podem ser solicitados em separado.

Related products that were not included in the set but can be ordered separately.

DESCRIPCIÓN / Descrição / Description

MITSUBISHI: Montero - Galant V6 12V
HYUNDAI: Sonata

MOTOR / Engine	CM ³	HP	Ø PISTON
6G72 12V	2972	140	91.10

Juego Completo de Reparación:

Jogo de Juntas do Motor / Full Set Gasket:

JR-764-07



Semi-Juego de Reparación:

Semi-Jogo de Juntas / Semi-Set Gasket:

Juego de Descarbonización:

Jogo de Juntas Superior / Head Set Gasket:

JUNTA CULATA DE CILINDROS	TC-950-07	Ø 93.00mm	1.30mm	↑ ↓
Junta de cabeçote				↑ ↓
Cylinder Head gasket				↑ ↓



TC-950-07 -
 Junta Culata de Cilindros
 Junta Cabeçote



Juego Admisión
 Jogo Admissão



Junta



Juego Admisión
 Jogo Admissão



Juego Escape
 Jogo Escapamento



Junta



Junta



Junta



Junta Tapa de Válvula
 Junta Tampa de Válvula



Distribución
 Distribuição



Junta



Retén Bancada
 Retentor Traseiro do
 Virabrequim
 91,00 x 111,00 x 9,00



Retén Distribución
 Retentor Dianteiro do
 Virabrequim
 37,00 x 50,20 x 6,00



Retén árbol de levas
 Retentor do Eixo Comando de Válvulas
 35,00 x 50,00 x 6,00



Juego Retenes
 Guia de Válvulas
 Jogo Retentor da Haste
 de Válvulas



Productos relacionados no incluidos en el juego. Los mismos pueden ser solicitados por separado.

Produtos relacionados não incluídos no jogo. Podem ser solicitados em separado.

Related products that were not included in the set but can be ordered separately.

Juego Completo de Reparación:

Jogo de Juntas do Motor / Full Set Gasket:

JR-744-07**R**

DESCRIPCIÓN / Descrição / Description

MITSUBISHI: Pajero Triton 2001/...
Montero III 2000/...

MOTOR / Engine

CM³

HP

Ø PISTON

4M41 TD 16V

3200

165/175

98.50

ILLINOIS

MITSUBISHI

Semi-Juego de Reparación:

Semi-Jogo de Juntas / Semi-Set Gasket:

Juego de Descarbonización:

Jogo de Juntas Superior / Head Set Gasket:

JUNTA CULATA DE CILINDROS	TC-949-07	Ø 99.50mm	1.70mm	↑ ↓
Junta de cabeçote		Ø	↑ ↓	↑ ↓
Cylinder Head gasket		Ø	↑ ↓	↑ ↓

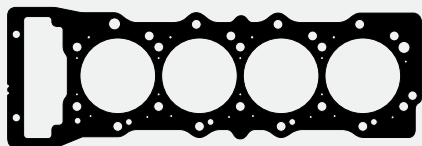

TC-949-07 - ME204037
Junta Culata de Cilindros
Junta Cabeçote



Junta



Junta



Junta Admisión
Junta Admissão



Juego Escape
Jogo Escapamento



Junta

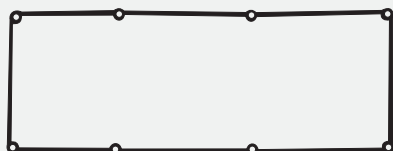

Junta Tapa Válvula Superior
Junta Tampa Válvula Superior



Bomba de agua
Bomba de água



Junta

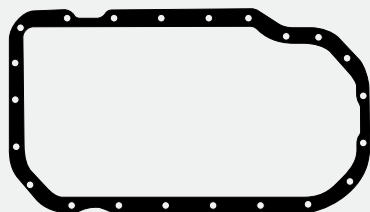

Junta Cáster
Junta Carter



Junta



Junta



Junta



Junta



Junta



Juego Retenes Guía de Válvulas
Jogo Retentor da Haste de Válvulas



Retén Bancada
Retentor Traseiro do Virabrequim



Retén Distribución
Retentor Dianteiro do Virabrequim

Productos relacionados no incluidos en el juego. Los mismos pueden ser solicitados por separado.

Produtos relacionados não incluídos no jogo. Podem ser solicitados em separado.

Related products that were not included in the set but can be ordered separately.

DESCRIPCIÓN / Descrição / Description

NISSAN: March - Versa 12V

MOTOR / Engine	CM ³	HP	Ø PISTON
HR10DE	999	76	78.00
HR12DE	1198	80	78.00

Juego Completo de Reparación:

Jogo de Juntas do Motor / Full Set Gasket:

JR-754-07



Semi-Juego de Reparación:

Semi-Jogo de Juntas / Semi-Set Gasket:

Juego de Descarbonización:

Jogo de Juntas Superior / Head Set Gasket:

JUNTA CULATA DE CILINDROS	TC-939-07	Ø 78.50mm	1.50mm	↑ ↓
Junta de cabeçote				↑ ↓
Cylinder Head gasket				↑ ↓

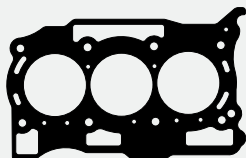

TC-939-07 - 110441HCOA
Junta Culata de Cilindros
Junta Cabeçote



Junta



Bomba de agua
Bomba de água



Junta Escape
Junta Escapamento



Juego Admisión
Jogo Admissão



Junta de goma
Junta de borracha

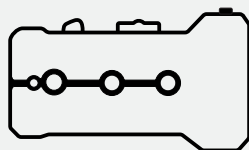

Junta Tapa Válvula Superior
Junta Tampa Válvula Superior



O'ring
16,5 x 2,4mm



O'ring
9,5 x 3,1mm



O'ring
9 x 3,5mm



Juego Retenes Guía de Válvulas
Jogo Retentor da Haste de Válvulas



Retén Bancada
Retentor Traseiro do Virabrequim
84,00 x 117,00 x 8,50



Retén Distribución
Ret. Dianteiro do Virabrequim
40,00 x 52,00 x 7,00

Productos relacionados no incluidos en el juego. Los mismos pueden ser solicitados por separado.

Produtos relacionados não incluídos no jogo. Podem ser solicitados em separado.

Related products that were not included in the set but can be ordered separately.

Juego Completo de Reparación:

Jogo de Juntas do Motor / Full Set Gasket:

JR-408-07**Semi-Juego de Reparación:**

Semi-Jogo de Juntas / Semi-Set Gasket:

Juego de Descarbonización:

Jogo de Juntas Superior / Head Set Gasket:

JUNTA CULATA DE CILINDROS	TC-488-07	∅ 75.50mm	1.50mm	↑ ↓
Junta de cabeçote				↑ ↓
Cylinder Head gasket				↑ ↓

DESCRIPCIÓN / Descrição / Description

NISSAN: Sunny 1200 - 120Y (10101M3025)

MOTOR / Engine	CM ³	HP	∅ PISTON
A12 OHC	1171	70	73.00

ILLINOIS

NISSAN



TC-488-07 - 11044H3901/25
11044H38504/9521
Junta Culata de Cilindros
Junta Cabeçote



Bomba de agua
Bomba de água



Bomba de aceite
Bomba de óleo



Múltiple Admisión y Escape
Coletor Admissão e Escapamento



Base filtro bomba aceite
Base filtro bomba óleo



O'ring 26 x 3mm



Juntas Tapa Válvula Superior
Junta Tampa Válvula Superior



Termostato
Termostato



Bomba de nafta
Bomba de gasolina

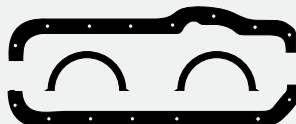

Junta Cártel
Junta Carter



Distribución
Distribuição



Capuchón
Capa

Productos relacionados no incluidos en el juego. Los mismos pueden ser solicitados por separado.

Produtos relacionados não incluídos no jogo. Podem ser solicitados em separado.

Related products that were not included in the set but can be ordered separately.

DESCRIPCIÓN / Descrição / Description

NISSAN: March - Sentra - Versa - Kicks - Livina
RENAULT: Captur - Duster - Duster Oroch
 Logan II - Sandero II

MOTOR / Engine	CM ³	HP	Ø PISTON
HR16DE H4M	1598	108	78.00

Juego Completo de Reparación:

Jogo de Juntas do Motor / Full Set Gasket:

JR-762-11



Semi-Juego de Reparación:

Semi-Jogo de Juntas / Semi-Set Gasket:

Juego de Descarbonización:

Jogo de Juntas Superior / Head Set Gasket:

JUNTA CULATA DE CILINDROS	TC-384-11	Ø 78.50mm	0.70mm	↕
Junta de cabeçote	TC-384-15	Ø 78.50mm	1.20mm	↕
Cylinder Head gasket				↕

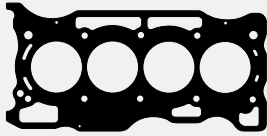

TC-384-11 - 11044BC20A/B
 Junta Culata de Cilindros
 Junta Cabeçote



Junta



Bomba de agua
 Bomba de água



Junta Escape
 Junta Escapamento



Junta Admisión
 Junta Admissão



Junta de goma
 Junta de borracha

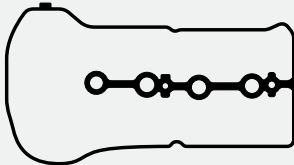

Junta Tapa Válvula Superior
 Junta Tampa Válvula Superior

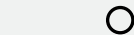

O'ring
 16,5 x 2,4mm



O'ring
 9,5 x 3,1mm



O'ring
 9 x 3,5mm



Juego Retenes Guía de Válvulas
 Jogo Retentor da Haste de Válvulas



Retén Bancada
 Retentor Traseiro do Virabrequim
 84,00 x 117,00 x 8,50



Retén Distribución
 Retentor Dianteiro do
 Virabrequim
 40,00 x 52,00 x 7,00

Productos relacionados no incluidos en el juego. Los mismos pueden ser solicitados por separado.

Produtos relacionados não incluídos no jogo. Podem ser solicitados em separado.

Related products that were not included in the set but can be ordered separately.

Juego Completo de Reparación:

Jogo de Juntas do Motor / Full Set Gasket:

JR-729**R****Semi-Juego de Reparación:**

Semi-Jogo de Juntas / Semi-Set Gasket:

SJ-729**R****Juego de Descarbonización:**

Jogo de Juntas Superior / Head Set Gasket:

JD-729**R**

JUNTA CULATA DE CILINDROS	TC-611-15	∅ 86.20mm	1.20mm	↑ ↓
Junta de cabeçote	TC-611-MG	∅ 86.20mm	1.20mm	↑ ↓
Cylinder Head gasket				↑ ↓

DESCRIPCIÓN / Descrição / Description

NISSAN: Sentra - Tiida - Qashqai - X-Trail 2007/...
Versa 2006/... - Livina / Gran Livina 2008/... - Cube 2009/...
RENAULT: Clio III 2006/08 - Laguna III 2007/...
Scenic III - Megane III 2009/... (10101EN228)

MOTOR / Engine	CM ³	HP	∅ PISTON
MR18DE 16V	1797	124/126	84.00
MR20DE 16V	1998	140	84.00
M4R-700/1/4/11/26 16V	1997	139	84.00

ILLINOIS

NISSAN

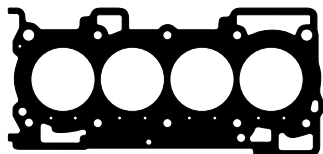
**JD-729**

TC-611 - 11044EN200/7701065095
Junta Culata de Cilindros
Junta Cabeçote



2767300
Junta



RT-2984PoI
Retén Distribución
Retentor Dianteiro do Virabrequim
83,50 x 117,50 x 8,50



JAE-588-A - 14035ED800/ELO0A
Junta Admisión
Junta Admissão
(Nissan)



JAE-587-E - 14036ED800
Junta Escape
Junta Escapamento



RT-2983PoI
Retén Reforma Bancada
Retentor Traseiro do Virabrequim
46,00 x 58,00 x 7,00



JAE-589-A
Junta Admisión
Junta Admissão
(Renault)



2767200
Caja Mariposa
Caixa Borboleta



RT-897Vit
Juego Retenes Guía de Válvulas
Jogo Retentor da Haste de Válvulas



JVS-383-43 - 13270EN200
Junta Tapa Válvula Superior
Junta Tampa Válvula Superior



1009900
Base termostato
Base termostato



1002000
Bomba de agua
Bomba de água

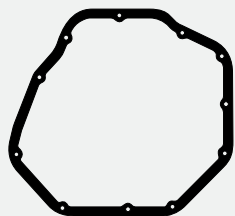

JC-396-26
Junta Cártier
Junta Carter



2617100
Arandela 20 x 26 x 1mm
Arruela (Aluminio)



2767400
Entrada de agua
Entrada de água

2769300 - Juego Arandelas de Goma/Jogo Arruelas de Borracha

Gráfico	Descripción/Descrição	Cant./Quant.
○	O'ring 22,5x2,5mm	1
○	O'ring 20,3x2,62mm	1
○	O'ring 16x2,5mm	1
○	O'ring 13,11x2,62mm	1
○	O'ring 9,19x2,62mm	1
○	O'ring 7,62x3,53mm	1

Productos relacionados no incluidos en el juego. Los mismos pueden ser solicitados por separado.

Produtos relacionados não incluídos no jogo. Podem ser solicitados em separado.

Related products that were not included in the set but can be ordered separately.



JSA-324-21
Junta Salida Escape
Junta Saída Escapamento
Motor M4R



JSA-326-21
Junta Salida Escape
Junta Saída Escapamento
Motor MR18/MR20

DESCRIPCIÓN / Descrição / Description **DIESEL**

NISSAN: Cabstar 1982/... - Homer - Serena
(1010109W25/T8225/T8227)

MOTOR / Engine	CM ³	HP	Ø PISTON
SD23	2289	68	89.00

Juego Completo de Reparación:

Jogo de Juntas do Motor / Full Set Gasket:

JR-668-20

Semi-Juego de Reparación:

Semi-Jogo de Juntas / Semi-Set Gasket:

Juego de Descarbonización:

Jogo de Juntas Superior / Head Set Gasket:

JUNTA CULATA DE CILINDROS	TC-110-20	Ø 92.00mm	1.40mm	1.40mm	1.40mm
Junta de cabeçote		Ø			
Cylinder Head gasket		Ø			

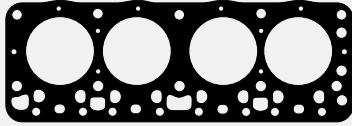

TC-110-20 - 11044L2000/09W01
Junta Culata de Cilindros
Junta Cabeçote



Bomba de agua
Bomba de água



Bomba de combustible
Bomba de combustível



Junta Escape
Junta Escapamento



Junta



Junta



Juntas Tapa Válvula Superior
Junta Tampa Válvula Superior



Junta

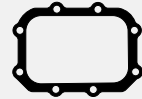

Junta



Junta Cártér
Junta Carter

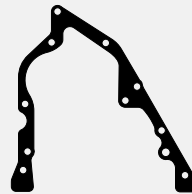

Junta

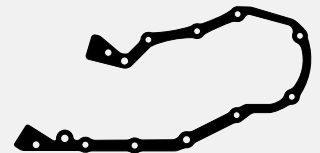

Junta



Junta



Junta

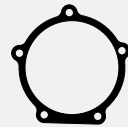

Junta



Junta



Junta

Productos relacionados no incluidos en el juego. Los mismos pueden ser solicitados por separado.

Produtos relacionados não incluídos no jogo. Podem ser solicitados em separado.

Related products that were not included in the set but can be ordered separately.

Juego Completo de Reparación:

Jogo de Juntas do Motor / Full Set Gasket:

JR-730-11

DESCRIPCIÓN / Descrição / Description

DIESEL

NISSAN: Cabstar 2006/... - Frontier 2009/...
 Hardbody 2006/... - King Cab TD 2001/...
 Pathfinder 2005/... - Navara 2005/...
 (10101UK525/10101UK527)

MOTOR / Engine	CM ³	HP	Ø PISTON
YD25DDTI 16V	2488	133/172	89.00

ILLINOIS

NISSAN

Juego de Descarbonización:

Jogo de Juntas Superior / Head Set Gasket:

JUNTA CULATA DE CILINDROS	TC-337-07	Ø 89.00mm	1.60mm	↑ ↓
	TC-337-11	Ø 89.00mm	0.90mm	↑ ↓
Junta de cabeçote				↑ ↓
Cylinder Head gasket				↑ ↓

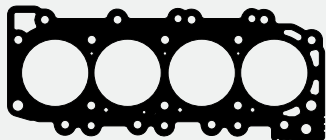

TC-337-11 - 11044VK500
 Junta Culata de Cilindros
 Junta Cabeçote



Junta



Junta



Junta



Junta Escape
 Junta Escapamento



Junta Admisión
 Junta Admissão



Brida
 Flange



Brida
 Flange



Junta Tapa Válvula Superior
 Junta Tampa Válvula Superior



Bomba de agua
 Bomba de água



Junta



Junta

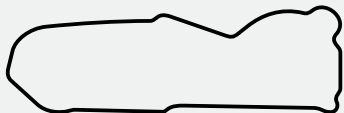

Tapa lateral
 Tampa laterla



Brida
 Flange



Junta



Juego Retenes Guía de Válvulas
 Jogo Retentor da Haste de Válvulas



Retén Bancada
 Retentor Traseiro do Virabrequim
 50,00 x 62,00 x 7,00



Retén Distribución
 Retentor Dianteiro do Virabrequim
 85,00 x 104,00 x 8,50

Productos relacionados no incluidos en el juego. Los mismos pueden ser solicitados por separado.

Produtos relacionados não incluídos no jogo. Podem ser solicitados em separado.

Related products that were not included in the set but can be ordered separately.

DESCRIPCIÓN / Descrição / Description **DIESEL**

NISSAN: Terrano D 1986/... Terrano TD 1989/92
 Pathfinder D - Truck D21 (1010143G27)
FORD: Maverick TD 1992/99

MOTOR / Engine	CM ³	HP	Ø PISTON
TD27 - TD27T	2663	85/100	96.00

Juego Completo de Reparación:

Jogo de Juntas do Motor / Full Set Gasket:

Semi-Juego de Reparación:

Semi-Jogo de Juntas / Semi-Set Gasket:

SJ-527

Juego de Descarbonización:

Jogo de Juntas Superior / Head Set Gasket:

JUNTA CULATA DE CILINDROS	TC-282-20 1M	Ø 98.90mm	1.25mm	±0.05
Junta de cabeçote	TC-282-20 2M	Ø 98.90mm	1.35mm	±0.05
Cylinder Head gasket	TC-282-20 3M	Ø 98.90mm	1.45mm	±0.05

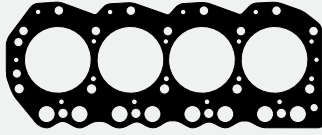

TC-282-20 1M - 1104443G01
 TC-282-20 2M - 1104443G02
 TC-282-20 3M - 1104443G03
 Junta Culata de Cilindros
 Junta Cabeçote



Acople bomba inyectora
 Acoplamento bomba injetora



Base termostato
 Base termostato



Junta Admisión
 Junta Admissão



Juego Escape
 Jogo Escapamento



Cámara agua con cierre
 Câmara água com fechamento



Junta Tapa Válvula
 Junta Tampa Válvula



Guarnición bomba de aceite
 Guarnição bomba de óleo



Guarnición
 Guarnição



Junta Cártel
 Junta Carter

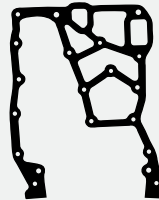

Distribución
 Distribuição



Guarnición
 Guarnição



Tapa termostato
 Tampa termostato



Placa filtro aceite
 Placa filtro óleo



Bomba de agua
 Bomba de água



Inspección distribución
 Inspeção distribuição

Productos relacionados no incluidos en el juego. Los mismos pueden ser solicitados por separado.

Produtos relacionados não incluídos no jogo. Podem ser solicitados em separado.

Related products that were not included in the set but can be ordered separately.



BU-522
 Bulones para Culata de Cilindros
 Parafusos de Cabeçote

Juego Completo de Reparación:

Jogo de Juntas do Motor / Full Set Gasket:

JR-765-07

DESCRIPCIÓN / Descrição / Description

DIESEL**NISSAN: Pathfinder II V6 4WD (101010W025)****Semi-Juego de Reparación:**

Semi-Jogo de Juntas / Semi-Set Gasket:

Juego de Descarbonización:

Jogo de Juntas Superior / Head Set Gasket:

JUNTA CULATA DE CILINDROS	TC-941-07	∅ 92.50mm	1.20mm	↑ ↓ ↑ ↓ ↑ ↓ ↑ ↓
Junta de cabeçote		∅	↑ ↓ ↑ ↓ ↑ ↓ ↑ ↓	
Cylinder Head gasket		∅	↑ ↓ ↑ ↓ ↑ ↓ ↑ ↓	

MOTOR / Engine	CM ³	HP	∅ PISTON
VG33E/R	3275	180/210	91.50

ILLINOIS

NISSAN



TC-941-07 - 110440W000/7B000
Junta Culata de Cilindros
Junta Cabeçote



Junta



Junta



Juego Escape
Jogo Escapamento



Junta



Junta Admisión
Junta Admissão



Juego Admisión
Jogo Admissão



Distribución
Distribuição



Distribución
Distribuição



Junta Tapa Válvula Superior
Junta Tampa Válvula Superior



Retén Árbol de levas
Retentor do Eixo Comando
de Válvulas
34,00 x 48,00 x 8,00



Juego Ret. Guía de Válvulas
Jogo Retentor da Haste de Válvulas



Retén Bancada
Retentor Traseiro do
Virabrequim
84,00 x 104,00 x 11,00



Retén Distribución
Retentor Dianteiro do Virabrequim
33,00 x 47,00 x 8,00

Productos relacionados no incluidos en el juego. Los mismos pueden ser solicitados por separado.

Produtos relacionados não incluídos no jogo. Podem ser solicitados em separado.

Related products that were not included in the set but can be ordered separately.

DESCRIPCIÓN / Descrição / Description

OPEL: Rekord - Caravan 1958/60

MOTOR / Engine	CM ³	HP	Ø PISTON
	1488	44	

Juego Completo de Reparación:

Jogo de Juntas do Motor / Full Set Gasket:

JR-188-15

Semi-Juego de Reparación:

Semi-Jogo de Juntas / Semi-Set Gasket:

Juego de Descarbonización:

Jogo de Juntas Superior / Head Set Gasket:

JUNTA CULATA DE CILINDROS	TC-352-05	Ø 82.00mm	1.70mm	1062500
Junta de cabeçote				1062500
Cylinder Head gasket				1062500



TC-352-05 - 607412
Junta Culata de Cilindros
Junta Cabeçote



JAE-258 - 850691
Múltiple Admisión y Escape
Coletor Admissão e Escapeamento



JVS-172-30 - 12682
Junta Tapa Válvula Superior
Junta Tampa Válvula Superior



JVL-153-30 - 42572
Junta Tapa Válvula Lateral
Junta Tampa Válvula Lateral

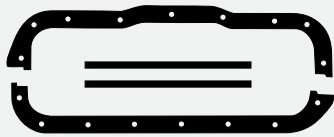

JC-200-30 - 12573/78
Junta Cáster
Junta Carter



1022100 - 116202/828429
Carburador
Carburador



1058600 - 1334731
Codo de agua
Cotovelo de água



1060000 - 818603
Bomba de nafta
Bomba de gasolina



1063100 - 830675
Carburador
Carburador



1058500 - 14001
Bomba de agua
Bomba de água



1057300 - 16187
Tapa placa distribución
Tampa placa distribuição



1062300 - 16193
Arandela corcho y goma
Arruela cortiça e borracha
(3mm)



1062500 - 16184
Salida de agua
Saída de água



1060900 - 14004
Bomba de aceite
Bomba de óleo



1063600 - 14006
Termostato
Termostato



1060600 - 17815
Bomba de agua
Bomba de água



1057200 - 12004
Tapa distribución
Tampa distribuição



1062100 - 16192
Arandela corcho y goma
Arruela cortiça e borracha
(6mm)

Productos relacionados no incluidos en el juego. Los mismos pueden ser solicitados por separado.

Produtos relacionados não incluídos no jogo. Podem ser solicitados em separado.

Related products that were not included in the set but can be ordered separately.

Juego Completo de Reparación:

Jogo de Juntas do Motor / Full Set Gasket:

JR-251-05**Semi-Juego de Reparación:**

Semi-Jogo de Juntas / Semi-Set Gasket:

Juego de Descarbonización:

Jogo de Juntas Superior / Head Set Gasket:

JUNTA CULATA DE CILINDROS	TC-413-05	∅ 96.00mm	1.60mm	↑ ↓	↑ ↓	↑ ↓	↑ ↓
Junta de cabeçote		∅		↑ ↓	↑ ↓	↑ ↓	↑ ↓
Cylinder Head gasket		∅		↑ ↓	↑ ↓	↑ ↓	↑ ↓

DESCRIPCIÓN / Descrição / Description

OPEL: Opel K 180 1974/79
CHEVROLET: Opala 1968/73

MOTOR / Engine	CM ³	HP	∅ PISTON
K180 - 153	1790		90.49

ILLINOIS

OPEL



TC-413-05 - 2637381
Junta Culata de Cilindros
Junta Cabeçote



JSA-165 - 2638526
Salida Escape
Saída Escapamento



1061900 - 2637457
Entre caño múltiple
Entre cano coletor



JAE-304 - 2637660/3788539
Múltiple Admisión y Escape
Coletor Admissão e Escapamento



1012000 - 3701777
Termostato
Termostato



1012500 - 3789161
Cubierta termostato
Cobertura termostato



JVS-202-30 - 3873851
Junta Tapa Válvula Superior
Junta Tampa Válvula Superior



1012700 - 5753411
Base carburador
Base carburador



1012600 - 3789970
Bomba de aceite
Bomba de óleo



JVL-155-30 - 3788549
Junta Tapa Válvula Lateral
Junta Tampa Válvula Lateral



1131000
Base bomba de aceite
Base bomba de óleo



1012100 - 5752131
Bomba de nafta
Bomba de gasolina

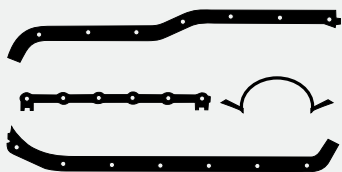

JC-246-30 - 7322169
Junta Cáster
Junta Carter



1012200 - 3788471
Tapa distribución
Tampa distribuição



1012300 - 3788478
Bomba de agua
Bomba de água

Productos relacionados no incluidos en el juego. Los mismos pueden ser solicitados por separado.

Produtos relacionados não incluídos no jogo. Podem ser solicitados em separado.

Related products that were not included in the set but can be ordered separately.



RT-519Pol
Jgo. Retenes Guía de Valv.
Jogo Retentor da Haste de Válvulas



RT-6691Pol
Retén Distribución
Retentor Dianteiro do Virabrequim
Mx-R 44,85 x 61,42 x 9,52

DESCRIPCIÓN / Descrição / Description **DIESEL**

DODGE: Polara - D100 - D200 1987/...
FORD: F100 - Pick Up - Falcon 1970/...
JEEP: T1000 1969/80

MOTOR / Engine	CM ³	HP	Ø PISTON
4.203 - P4 - 192Z	3336	71	91.49

Juego Completo de Reparación:

Jogo de Juntas do Motor / Full Set Gasket:

JR-190

R

Semi-Juego de Reparación:

Semi-Jogo de Juntas / Semi-Set Gasket:

SJ-210

R

Juego de Descarbonización:

Jogo de Juntas Superior / Head Set Gasket:

JD-113-01

R

JD-113-ST

R

JUNTA CULATA DE CILINDROS	TC-361-01	Ø 93.00mm	1.35mm	↕
Junta de cabeçote	TC-607-20	Ø 93.00mm	1.50mm	↕
Cylinder Head gasket				↕

JD-113-01

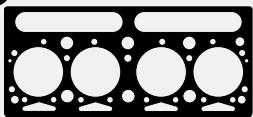

TC-361-01 - RP006356/36812125
 Junta Culata de Cilindros
 Junta Cabeçote

JD-113-ST

2731800 - 006073
 Apriete válvulas
 Ajuste válvulas

1063000
 0490485/36846409
 Tapa trasera
 Tampa traseira

1062800
 0490024/36817141/0490701
 Salida agua
 Saída água



JAE-263-09 - 0490481
 0490028/006002/0490044
 Juego Escape
 Jogo Escapamento

JAE-357-A - 006061
 0490042/80490032
 Junta Admisión
 Junta Admissão

JSA-151 - 80490032
 Salida Escape
 Saída Escapamento

2605700 - 0920113
 Arandela inyector
 Arruela injetor
 14 x 20 x 2mm (Cobre)

2731900 - 0490687
 Tapa recipiente combustible
 Tampa recipiente combustível

JVS-174-30 - 0490704
 Junta Tapa Válvula Superior
 Junta Tampa Válvula Superior

1062700 - 0490023/006054
 Precámara
 Précâmara

1064000 - 36835411/0490707
 Conexión salida agua
 Conexão saída água

RT-501Pol
 Jgo. Ret. Guía Válvulas
 Jgo. Ret. da Haste de Válv.

JC-210-25
 Junta Carter (1mm)
 Junta Carter

1063700 - 36813117
 Tapa distribución
 Tampa distribuição

1063800 - 36814112
 Caja distribución
 Caixa distribuição

1066300 - 33826111
 Porta retén cigüeñal
 Porta retentor virabrequim

1063300 - 0490692
 Conexión entrada agua
 Conexão entrada água

1064200 - 36862165/52
 Bomba alimentación
 Bomba alimentação

1062600 - A002242
 Filtro aceite
 Filtro óleo

1062900 - 0490391
 Salida de agua
 Saída de água

1064100 - 36853105
 Toma fuerza
 Tomada força

1063400 - 0490699
 Tapa trasera block
 Tampa traseira bloco

1064400 - 36866428
 Bomba vacío
 Bomba vácuo

1064300 - 36866417
 Bomba de agua
 Bomba d'água

RT-8070Pol
 Retén Distribución
 Ret. Dianteiro do Virabrequim
 Mz-R 60,32 x 79,35 x 11,00

RT-6823Vit
 Retén Bancada
 Ret. Traseiro do Virabrequim
 Lx-R 133,35 x 158,75 x 12,50

1054100
 33852409/066081
 Tapa/Tampa frontal

1063900 - 36817134/006081
 Tapa trasera cigüeñal
 Tampa traseira virabrequim

1108500
 36866416/70490267
 Adaptador

1107400 - 0490685/99
 0490773
 Bomba de combustible
 Bomba de combustível

1053100 - 006007
 0490514/70730006
 Filtro de aceite
 Filtro de óleo

1063500 - 0490706
 36865543
 Bomba inyectora
 Bomba injetora

2629600 - Juego Arandelas Metálicas/Jogo Arruelas Metálicas

Gráfico	Descripción/Descrição	Cant./Quant.
	Ar./Arruela 19,2x27,5x2mm Aluminio	1
	Ar./Arruela 17,4x22,3x1mm Aluminio	10
	Ar./Arruela 13,2x20x1mm Aluminio	10
	Ar./Arruela 10,2x14,15x1mm Alum.	15
	Ar./Arruela 8,15x12,6x1mm Aluminio	15

Productos relacionados no incluidos en el juego. Los mismos pueden ser solicitados por separado.

Produtos relacionados não incluídos no jogo. Podem ser solicitados em separado.

Related products that were not included in the set but can be ordered separately.



BU-505
 Bulones para Culata de Cilindros
 Parafusos de Cabeçote



1163300
 Termostato
 Termostato

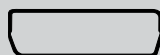

JVS-174-23
 Junta Tapa Vál. Sup.
 Junta Tampa Válvula Superior



JC-210-26
 Junta Carter
 Junta Carter (1,5mm)



1158000
 Tapa Trasera Cigüeñal
 Tampa virabrequim traseira (Reforma)

Juego Completo de Reparación:

Jogo de Juntas do Motor / Full Set Gasket:

JR-328



Semi-Juego de Reparación:

Semi-Jogo de Juntas / Semi-Set Gasket:

SJ-262



Juego de Descarbonización:

Jogo de Juntas Superior / Head Set Gasket:

JD-113-01

JD-161-20



JUNTA CULATA DE CILINDROS	TC-361-01	Ø 93.00mm	1.35mm	±0.05
	TC-607-20	Ø 93.00mm	1.50mm	±0.05
Junta de cabeçote				
Cylinder Head gasket				

DESCRIPCIÓN / Descrição / Description

DIESEL

FORD: F100

MOTOR / Engine	CM ³	HP	Ø PISTON
4.203 Potenciado	3336	71	91.44

ILLINOIS

PERKINS

JD-113-01 - JD-161-20

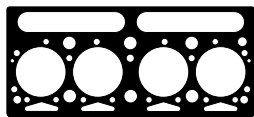

TC-361-01 - TC-607-20
RP006356/36812125
Junta Culata de Cilindros
Junta Cabeçote



JAE-357-A - 006061
0490042/80490032
Junta Admisión
Junta Admissão



JVS-174-30 - 0490704
Junta Tapa Válvula Superior
Junta Tampa Válvula Superior

2731800 - 006073
Apriete válvulas
Ajuste válvulas

2605700 - 0920113
Arandela inyector
Arruela injetor
14 x 20 x 2mm (Cobre)

JAE-263-09 - 0490481
0490028/006002/0490044
Juego Escape
Jogo Escapamento

1062700 - 0490023/006054
Precámara
Précâmara

JSA-151 - 0490032
Salida Escape
Saída Escapamento

1062800 - 0490024
36817141/0490701
Salida agua
Saída água

1064000 - 36835411/0490707
Conexión salida agua
Conexão saída água

2731900 - 0490687
Tapa recipiente combustible
Tampa recipiente combustível

1063000 - 0490485/36846409
Tapa trasera
Tampa traseira

RT-501Pol
Jgo. Ret. Guía Válvulas
Jogo Retentor da Haste de Válvulas



JC-275-26
Junta Carter
Junta Carter

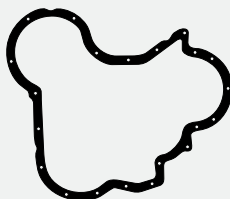

1063700 - 36813117
Tapa distribución
Tampa distribuição



1063800 - 36814112
Caja distribución
Caixa distribuição

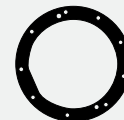

1066300 - 33826111
Porta retén cigüeñal
Porta retentor virabrequim

1053100 - 006007
0490514/70730006
Filtro de aceite
Filtro de óleo

1064200 - 36862165/52
Bomba alimentación
Bomba alimentação

1062600 - A002242
Filtro aceite
Filtro óleo

1062900 - 0490391
Salida de agua
Saída de água

1064100 - 36853105
Toma fuerza
Tomada força

1063400 - 0490699
Tapa trasera block
Tampa traseira bloco

1064400 - 36866428
Bomba vacío
Bomba vácuo

1064300 - 36866417
Bomba de agua
Bomba d'água

1107400 - 0490685/99/0490773
Bomba de combustible
Bomba de combustível

1063500 - 0490706
36865543
Bomba inyectora
Bomba injetora

1054100
33852409/066081
Tapa frontal
Tampa frontal

1063900 - 36817134/006081
Tapa trasera cigüeñal
Tampa traseira virabrequim

1108500
36866416/70490267
Adaptador

1063300 - 0490692
Conexión entrada agua
Conexão entrada água

RT-8070Pol
Retén Distribución
Ret. Dianteiro do Virabrequim
Mz-R 60,32 x 79,35 x 11,00

RT-6823Vit
Retén Bancada
Ret. Traseiro do Virabrequim
Lx-R 133,35 x 158,75 x 12,50

2629600 - Juego Arandelas Metálicas/Jogo Arruelas Metálicas

Gráfico	Descripción/Descrição	Cant./Quant.
	Ar./Arruela 19,2x27,5x2mm Aluminio	1
	Ar./Arruela 17,4x22,3x1mm Aluminio	10
	Ar./Arruela 13,2x20x1mm Aluminio	10
	Ar./Arruela 10,2x14,15x1mm Alum.	15
	Ar./Arruela 8,15x12,6x1mm Aluminio	15

Productos relacionados no incluidos en el juego. Los mismos pueden ser solicitados por separado.

Produtos relacionados não incluídos no jogo. Podem ser solicitados em separado.

Related products that were not included in the set but can be ordered separately.



BU-505
Bulones para Culata de Cilindros
Parafusos de Cabeçote



1163300
Termostato

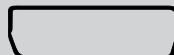

JVS-174-23
Junta Tapa/Tampa Válvula Superior



1158000
Tapa Traseira Cigüeñal
Tampa traseira virabrequim (Reforma)

DESCRIPCIÓN / Descrição / Description **DIESEL**

GM CHEVROLET: GM D10/20/40 Aspirado Turbo
MASSEY FERGUSON: MF220 - F290 - MF85X
MAXION - PERKINS: F350 - VW680 - Case 550
 Vehicular (424801/423607)

MOTOR / Engine	CM ³	HP	Ø PISTON
Q20B4 - 4.236	3860	70	98.40
4.248	4070	70	101.00

Juego Completo de Reparación:

Jogo de Juntas do Motor / Full Set Gasket:

JR-290-20

R

Semi-Juego de Reparación:

Semi-Jogo de Juntas / Semi-Set Gasket:

SJ-208

R

Juego de Descarbonización:

Jogo de Juntas Superior / Head Set Gasket:

JD-158-20

R

JUNTA CULATA DE CILINDROS	TC-450-20	Ø 104.00mm	1.65mm	104.00mm	1.65mm
Junta de cabeçote					
Cylinder Head gasket					



JD-158-20

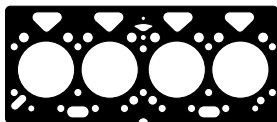

TC-450-20 - 70490195
 3681E016/18/36812338
 Junta Culata de Cilindros
 Junta Cabeçote



JSA-184 - 36822111
 Salida Escape
 Saída Escapamento



1108100 - 36851409
 Tapa trasera
 Tampa traseira



2621700 - 70920081
 Arandela Injetor
 Arruela injetor
 15 x 21 x 1mm (Cobre)



JAE-335 - 3688C001/002/007
 Múltiple Admisión y Escape
 Coletor Admissão e Escapamento



1107900 - 36835425
 Caja conexión superior
 Caixa conexão superior



1108300 - 36862151
 Conexión superior
 Conexão superior



RT-503PoI
 Jgo. Ret. Guía de Válvulas
 Jogo Retentor da Haste de Válvulas



JVS-233-30 - 70490266
 Junta Tapa Válvula Superior
 Junta Tampa Válvula Superior



1108200 - 36853514
 Cuerpo salida agua
 Corpo saída água



1107700 - 36825107
 Tapa inspección
 Tampa inspeção



1108500 - 36866416
 70490267
 Adaptador



JC-280-25 - 36815705/06
 Junta Cártér
 Junta Carter

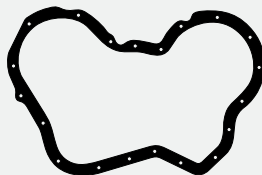

1107500 - 36813138
 Tapa distribución
 Tampa distribuição

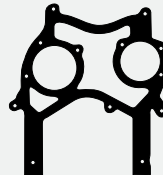

1107600 - 36814123/27/37
 Caja distribución
 Caixa distribuição



1038200 - 36817157
 Porta retén trasero
 Porta retentor traseiro



1108600 - 36866724
 Cuerpo trasero
 Corpo traseiro



1108900 - 70490146
 36867157
 Bomba de agua (0,5mm)
 Bomba d'água



1108800 - 70490144
 Bomba de agua
 Bomba d'água (1,5mm)



1016400 - 002951
 Junta



1067500 - 36817136
 Porta retén trasero
 Flange Traseiro do Virabrequim



1107400 - 0490685
 Bomba de combustible
 Bomba de combustivel



1108700 - 70490063/100
 Bomba a caja distribución
 Bomba a caixa distribuição



1108000 - 36851113
 Bomba de alimentación
 Bomba de alimentação



1064400 - 36866428
 Bomba vacío
 Bomba vácuo



1190500 - 70490145
 Cuerpo tras. bomba agua
 Corpo traseiro bomba água



1107800 - 36832122
 Bomba de aceite
 Bomba de óleo



1108400 - 36862517
 Filtro de aceite
 Filtro de óleo



1107300 - 0490355
 Válvula alivio
 Válvula alívio



1046700 - 36862138
 Junta



1109000 - C70730006
 Juego bancada
 Jogo mancal



RT-6823Vit
 Retén Bancada
 Ret. Traseiro do Virabrequim
 Lx-R 133,35 x 158,75 x 12,50



RT-8070PoI
 Retén Distribución
 Ret. Dianteiro do Virabrequim
 Mz-R 60,32 x 79,35 x 11,00

Productos relacionados no incluidos en el juego. Los mismos pueden ser solicitados por separado.

Produtos relacionados não incluídos no jogo. Podem ser solicitados em separado.

Related products that were not included in the set but can be ordered separately.

Juego Completo de Reparación:

Jogo de Juntas do Motor / Full Set Gasket:

JR-694-15**Semi-Juego de Reparación:**

Semi-Jogo de Juntas / Semi-Set Gasket:

SJ-694**Juego de Descarbonización:**

Jogo de Juntas Superior / Head Set Gasket:

JD-694-15

JUNTA CULATA DE CILINDROS	TC-925-15	∅ 73.50mm	1.50mm	∅
	TC-925-MG	∅ 73.50mm	1.50mm	∅
Junta de cabeçote		∅		∅
Cylinder Head gasket		∅		∅

DESCRIPCIÓN / Descrição / Description

PEUGEOT: 106 1991/... - 205 1987/93 - 306

Partner 1996/...

CITROEN: Saxo - ZX - Berlingo 1996/...

C15 1988/... - AX 10 1986/...

MOTOR / Engine	CM ³	HP	∅ PISTON
TU9/K/MZ/M	954	45/50	70.00
TU1M	1124	54/60	72.00

ILLINOIS

PEUGEOT

**JD-694-15****TC-925-15**
Junta Culata de Cilindros
Junta Cabeçote**JSA-339**
Salida Escape
Saída Escapamento**2706800**
O'ring 79,5 x 3mm**2739800**
O'ring 36,5 x 3,1mm**JAE-429-A**
Juego Admisión
Jogo Admissão**JAE-428-E**
Juego Escape
Jogo Escapamento**2740100**
Anillo termostato
Anel termostato**1402100**
Brida
Flange**JVS-271-43 - 024954**
Junta Tapa Válvula Superior
c/arandelas
Junta Tampa Válvula Superior
c/arruelas**1179000 - 1416A5**
Base carburador
Base carburador**RT-614Pol**
Juego Retenes Guía de Válvulas
Jogo Retentor da Haste de Válvulas**RT-8796Pol**
Retén Árbol de Levas Lx-Hel
Retentor do Eixo Comando
de Válvulas
36,00 x 50,00 x 7,00**JC-325-26 - 030430**
Junta Carter
Junta Carter**2739700**
O'ring 52,07 x 2,62mm**1402000**
Bomba combustible
Bomba combustível**2613900 - Juego Arandelas Metálicas/Jogo Arruelas Metálicas**

Gráfico	Descripción/Descrição	Cant./Quant.
	Ar./Arruela 20x26x2mm Fibra	1
	Ar./Arru. 12x18x1mm Cobre	1
	Ar./Arruela 8x20x1,5mm Fibra	3
	Ar./Arruela 16x22x1,5mm Aluminio	1

**RT-9192Pol**
Retén Distribución Lx-R
Retentor Dianteiro do Virabrequim
42,00 x 66,00 x 8,00**RT-6863Vit**
Retén Bancada Lx-R
Retentor Traseiro do Virabrequim
85,00 x 105,00 x 12,00

Productos relacionados no incluidos en el juego. Los mismos pueden ser solicitados por separado.

Produtos relacionados não incluídos no jogo. Podem ser solicitados em separado.

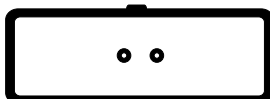
Related products that were not included in the set but can be ordered separately.

DESCRIPCIÓN / Descrição / Description

PEUGEOT: 104 1975/... - 205 1983/87
CITROEN: Visa II - C15 - Visa Super

MOTOR / Engine	CM ³	HP	Ø PISTON
XW3-XW7	1124	55/57	72.00
XZ5	1219	57	75.00

Juego Completo de Reparación:

Jogo de Juntas do Motor / Full Set Gasket:

JR-381-15



Semi-Juego de Reparación:

Semi-Jogo de Juntas / Semi-Set Gasket:

SJ-381



Juego de Descarbonización:

Jogo de Juntas Superior / Head Set Gasket:

JD-381-15



JUNTA CULATA DE CILINDROS	TC-105-15	Ø 76.00mm	1.60mm	1.60mm	1.60mm	1.60mm
Junta de cabeçote						
Cylinder Head gasket						

JD-381-15

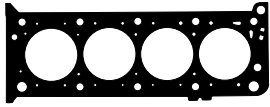

TC-105-15
Junta Culata de Cilindros
Junta Cabeçote



JSA-148 - 1710070
Salida Escape
Saída Escapamento



1056400
Bomba de agua
Bomba de água



2739600 - 1339530
O'ring termostato



JAE-485-A
Juego Admisión
Jogo Admissão



JAE-486-E - 1723630
Junta Escape
Junta Escapamento



1056200
Base carburador
Base carburador



RT-575Pol
Jgo. Ret. Guía Válvulas
Jogo Retentor da Haste de Válvulas



JVS-323-43
Junta Tapa Válvula Superior
Junta Tampa Válvula Superior



2745400 - 7700575468
7701348178
Juego suplemento camisa (Silicona)
Jogo suplemento camisa (Silicone)



1056100
Intermedia carburador
Intermediária carburador

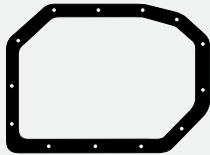

JC-349-26
Junta Cártér
Junta Carter



1059500
Frente distribución
Frente distribuição

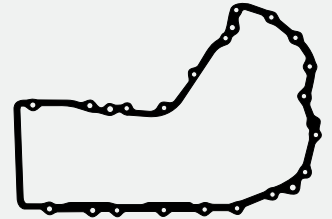

1056500
Frente distribución
Frente distribuição

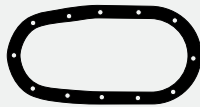

1055900
Cubierta trasera embrague
Coberta traseira embreagem



1056300
Base bomba de nafta
Base bomba de gasolina

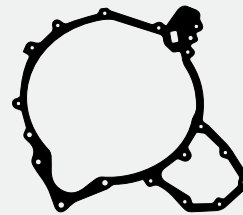

1056000
Cubre volante embrague
Coberta volante embreagem



RT-6905
Retén Distribución
Retentor Dianteiro do Virabrequim
Lt 12,00 x 19,00 x 5,00

2623200 - Juego Arandelas Metálicas/Jogo Arruelas Metálicas

Gráfico	Descripción/Descrição	Cant./Quant.
○	Ar./Arru. blindada 18x24x2,5mm Cobre	2
○	Ar./Arru. blindada 16x22mm Cobre	2
○	Ar./Arru. 19x23x1,5mm Fibra	1
●	Ar./Arru. 9,5x20x3mm Fibra	3
○	Ar./Arru. 13x18x1,5mm Fibra	1
○	Ar./Arru. 7x13x1,5mm Fibra	1

2723200 - Juego Arandelas de Goma/Jogo Arruelas de Borracha

Gráfico	Descripción/Descrição	Cant./Quant.
○	O'ring 36,8x3mm	1
○	O'ring 31x3mm	1
○	O'ring 16x2mm Salida depresora	1
○	O'ring 14x2mm	2

Productos relacionados no incluidos en el juego. Los mismos pueden ser solicitados por separado.

Produtos relacionados não incluídos no jogo. Podem ser solicitados em separado.

Related products that were not included in the set but can be ordered separately.

Juego Completo de Reparación:

Jogo de Juntas do Motor / Full Set Gasket:

JR-379-15**Semi-Juego de Reparación:**

Semi-Jogo de Juntas / Semi-Set Gasket:

SJ-279**Juego de Descarbonización:**

Jogo de Juntas Superior / Head Set Gasket:

JD-175-15

JUNTA CULATA DE CILINDROS	TC-649-15	∅ 76.00mm	1.50mm	↑ ↓
	TC-649-18	∅ 76.00mm	2.30mm	↑ ↓
Junta de cabeçote		∅		↑ ↓
Cylinder Head gasket		∅		↑ ↓

DESCRIPCIÓN / Descrição / Description

PEUGEOT: 106 1991/... - 205 1987/96 - 205 Rallye 1988/93
206 1998/... - 306 1993/97 - 405 1987/96 - Partner 1996/...
CITROEN: AX11 - AX SPORT 1987/91 - AX GTI 1992/...
BX11 - BX14 - ZX 1991/98 - C15 1986/... - Saxo - Xsara

MOTOR / Engine	CM ³	HP	∅ PISTON
TU1/TU1M	1124	55/60	72.00
TU2.4	1294	102	75.00
TU3	1360	95/100	75.00

ILLINOIS

PEUG. / CITROEN

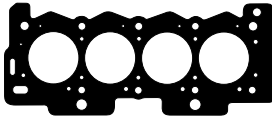
**JD-175-15**

TC-649-15 - 020989
Junta Culata de Cilindros
Junta Cabeçote



JSA-267
Salida Escape
Saída Escapamento



2739800
O'ring 36,5 x 3,1mm



JAE-429-A
Juego Admisión
Jogo Admissão



JAE-428-E
Juego Escape
Jogo Escapamento



2740100
Anillo termostato
Anel termostato



RT-614Pol
Juego Retenes Guía de Válvulas
Jogo Retentor da Haste de Válvulas



JVS-271-43 - 024954
Junta Tapa Válvula Superior
c/arandelas
Junta Tampa Válvula Superior
c/arruelas



1179000 - 1416A5
Base carburador
Base carburador



1179800
Brida
Flange



RT-8796Pol
Retén Árbol de Levas Lx-Hel
Ret. do Eixo Comando de Válvulas
36,00 x 50,00 x 7,00

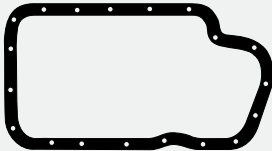

JC-325-26 - 030430
Junta Cáster
Junta Carter



2706800
O'ring 79,5 x 3mm

2629300 - Juego Arandelas Metálicas/Jogo Arruelas Metálicas

Gráfico	Descripción/Descrição	Cant./Quant.
	Ar./Arruela 22x30x2mm Cobre	2
	Ar./Arru. blindada 16x22mm Cobre	2
	Ar./Arruela 12x18x1,5mm Cobre	1



2745200
Juego arandelas camisa (Silicona)
Jogo arruelas camisa
(Silicone)



2739700
Anillo cubo bomba de agua
Anel cubo bomba de água
57 x 2,5mm



2739900
O'ring 22,1 x 3,6mm



RT-9196Vit
Retén Bancada Lx-R
Retentor Traseiro do Virabrequim
85,00 x 105,00 x 8,00



RT-9192Pol
Retén Distribución Lx-R
Retentor Dianteiro do Virabrequim
42,00 x 66,00 x 8,00

Productos relacionados no incluidos en el juego. Los mismos pueden ser solicitados por separado.

Produtos relacionados não incluídos no jogo. Podem ser solicitados em separado.

Related products that were not included in the set but can be ordered separately.



BU-033
Bulones para Culata de Cilindros
Parafusos de Cabeçote



JB-228
Juego Carburador
Jogo Carburador



JSA-246-21
Salida Escape
(Anillo Malla Acero)
Saída Escap. (Anel Malha Aço)

DESCRIPCIÓN / Descrição / Description			
PEUGEOT: 208 CITROEN: C3 III			
MOTOR / Engine	CM ³	HP	Ø PISTON
EB2M (HMY) 12V	1199	72	75.00

Juego Completo de Reparación: Jogo de Juntas do Motor / Full Set Gasket:		JR-785-11	
Semi-Juego de Reparación: Semi-Jogo de Juntas / Semi-Set Gasket:			
Juego de Descarbonización: Jogo de Juntas Superior / Head Set Gasket:			
JUNTA CULATA DE CILINDROS	TC-907-11	Ø 76.30mm	0.70mm
Junta de cabeçote			
Cylinder Head gasket			

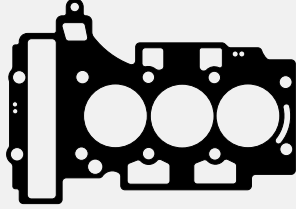

TC-907-11 - 9676148680
Junta Culata de Cilindros
Junta Cabeçote



1402200 - 9801596880
Bomba de água
Bomba de água



JSA-314 - 9688031280
Junta Salida Escape
Junta Saída Escapamento



JAE-293 - 1608733780
Juego Admisión
Jogo Admissão

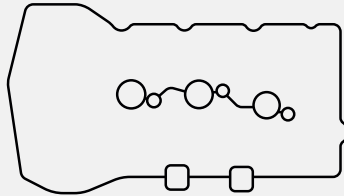

JVS-344-43 - 9677855380
Junta Tapa de Válvula Superior
Junta Tampa de Válvula Superior



1402300 - 9801737680
Termostato

Productos relacionados no incluidos en el juego. Los mismos pueden ser solicitados por separado.

Produtos relacionados não incluídos no jogo. Podem ser solicitados em separado.

Related products that were not included in the set but can be ordered separately.

Juego Completo de Reparación:

Jogo de Juntas do Motor / Full Set Gasket:

JR-197-15**Semi-Juego de Reparación:**

Semi-Jogo de Juntas / Semi-Set Gasket:

Juego de Descarbonización:

Jogo de Juntas Superior / Head Set Gasket:

JUNTA CULATA DE CILINDROS	TC-357-06	∅ 82.00mm	1.80mm	∅	∅	∅	∅
Junta de cabeçote							
Cylinder Head gasket							

DESCRIPCIÓN / Descrição / Description

PEUGEOT: 403/7 1959/66 - 403/8 1955/67 (0199130)

MOTOR / Engine	CM ³	HP	∅ PISTON
7CV	1290	52	75.00
8CV	1468	55/58	80.00

ILLINOIS

PEUGEOT

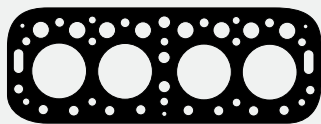
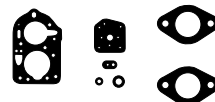
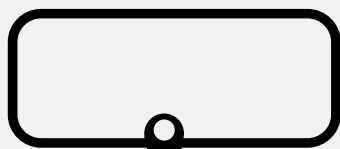
**TC-357-06** - 0203180
Junta Culata de Cilindros
Junta Cabeçote**JSA-147** - 1710040
Salida Escape
Saída Escapamento**1069300** - 0110401
Bomba de aceite
Bomba de óleo**JB-148 - Juego Carburador**
Jogo Carburador**JAE-260-09** - 0349030
Juego Escape
Jogo Escapamento**1068900** - 0236010
Tapa lateral
Tampa lateral**1071000** - 1451030
Bomba de nafta
Bomba de gasolina**1070700** - 1120010
Caño respiración
Tubo respiro**JVS-179-43** - 0249090
Junta Tapa Válvula Superior
Junta Tampa Válvula Superior**1069000** - 0313030
Desagüe cárter
Desague carter**1069100** - 0321050
Tapa distribución
Tampa distribuição**1069200** - 0321060
Placa distribución
Placa distribuição**JC-211-30**
Junta Cártter
Junta Carter**1069500** - 1206050
Bomba de agua
Bomba de água**2711500** - 0127050
Clavito bancada
(Sección circular)
Bastão traseiro virabrequim
(Seção circular)**2734700** - 0253050
Buje tornillo tapa válvula
Buchta Parafuso Tampa Válvulas**2732100** - 0213030
Arandela bujía
Arruela vela**1070400** - 5907001
Base distribuidor
Base distribuidor**RT-520Po1**
Jgo. Retenes Guía Válvulas
Jogo Retentor da Haste
de Válvulas**RT-6687Po1**
Retén
Retentor
A 156-R 42 x 60 x 10

Productos relacionados no incluidos en el juego. Los mismos pueden ser solicitados por separado.

Produtos relacionados não incluídos no jogo. Podem ser solicitados em separado.

Related products that were not included in the set but can be ordered separately.

DESCRIPCIÓN / Descrição / Description

DIESEL

PEUGEOT: 106 1994/...
CITROEN: AX 14 1988/94

MOTOR / Engine	CM ³	HP	Ø PISTON
TUD3	1360	52	75.00
TUD3 (K9A)	1360	50	75.00

Juego Completo de Reparación:

Jogo de Juntas do Motor / Full Set Gasket:

JR-469-20

R

Semi-Juego de Reparación:

Semi-Jogo de Juntas / Semi-Set Gasket:

SJ-469

R

Juego de Descarbonización:

Jogo de Juntas Superior / Head Set Gasket:

JD-469-20

R

JUNTA CULATA DE CILINDROS	TC-437-20	Ø 76.20mm	1.80mm	Arbol de Levas
Junta de cabeçote				Arbol de Levas
Cylinder Head gasket				Arbol de Levas



JD-469-20

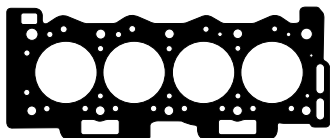

TC-437-20 - 0209E9
Junta Culata de Cilindros
Junta de Cabeçote



JAE-418-E - 0349E4
Junta Escape
Junta Escapamento



JVS-315-43 - 024976
Junta Tapa Válvula Superior
Junta Tampa Válvula Superior

2613300
Arandela 12 x 18 x 1,5mm
Arruela (Cobre)

2607400
Arandela parallama
(Acero) 6 x 14mm
Arruela Bico Injetor
(Aço)

2606400
Arandela 15 x 21 x 2mm
Arruela (Cobre)



JSA-259 - 170910
Salida Escape
Saída Escapamento

2731700 - Juego Arandelas de Goma/Jogo Arruelas de Borracha

Gráfico	Descripción/Descrição	Cant./Quant.
○	O'ring 47,3x2mm	1
○	Guarnición/Guarnição termostato	1
○	Ar. goma/borracha 11x15x3mm	8
○	O'ring 9,2x2,62mm	1



RT-8796Pol
Retén Árbol de Levas
Retenedor do Eixo Comando de Válvulas
A156-R 36,00 x 50,00 x 7,00



RT-576Pol
Jgo. Ret. Guía Válvulas
Jogo Ret. haste Válvulas



JC-325-26 - 030430
Junta Cártér
Junta Carter



2745400 - 7700575468/7701348178
Juego suplemento camisa (Silicona)
Jogo suplemento camisa (Silicone)



RT-6863Vit
Retén Bancada
Retenedor Traseiro do Virabrequim
Lx-R 85,00 x 105,00 x 12,00



RT-9192Pol
Retén Distribución
Retenedor Dianteiro do Virabrequim
Lx-R 42,00 x 66,00 x 8,00

2732200 - Juego Arandelas de Goma/Jogo Arruelas de Borracha

Gráfico	Descripción/Descrição	Cant./Quant.
○	O'ring 74x3mm	1
○	O'ring 57x2,5mm	1
○	O'ring 47,3x2,62mm	1
○	Termostato	1
○	O'ring 36,5x3,1mm	1

2604300 - Juego Arandelas Metálicas/Jogo Arruelas Metálicas

Gráfico	Descripción/Descrição	Cant./Quant.
○	Ar./Arruela 22x29x3mm Aluminio	2
○	Ar./Arruela 16x24x1mm Aluminio	1
○	Ar./Arruela 16x22x1,5mm Cobre	4
○	Ar./Arru. blindada 16x22x2,5mm Cobre	1
○	Ar./Arruela 14x18x2,5mm Cobre	8
○	Ar./Arruela 11x18x2mm Cobre	2
○	Ar./Arruela 12x17x2mm Cobre	2
○	Ar./Arruela 6x11x2mm Aluminio	2

Productos relacionados no incluidos en el juego. Los mismos pueden ser solicitados por separado.

Produtos relacionados não incluídos no jogo. Podem ser solicitados em separado.

Related products that were not included in the set but can be ordered separately.

Juego Completo de Reparación:

Jogo de Juntas do Motor / Full Set Gasket:

JR-509**R****Semi-Juego de Reparación:**

Semi-Jogo de Juntas / Semi-Set Gasket:

SJ-509**R****Juego de Descarbonización:**

Jogo de Juntas Superior / Head Set Gasket:

JD-509**R**

JUNTA CULATA DE CILINDROS	TC-648-15	∅ 76.00mm	1.50mm	↑ ↓
Junta de cabeçote	TC-648-MG	∅ 76.00mm	1.50mm	↑ ↓
Cylinder Head gasket	TC-648-18	∅ 76.00mm	2.30mm	↑ ↓

DESCRIPCIÓN / Descrição / Description

PEUGEOT: 106 1991/... - 206 1998/... - 207 Compact 306 1993/... - 307 2001/... - Partner 1996/...
CITROEN: C2 - C3 - C3 Pluriel 2002/... - Berlingo 1996/... Saxo ZX 1991/...
FIAT: Qubo - Fiorino Qubo

MOTOR / Engine	CM ³	HP	∅ PISTON
TU3JP	1360	68/75	75.00

ILLINOIS

PEUG. / CITROEN

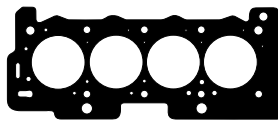
JD-509

TC-648 - 0209CK/020991
Junta Culata de Cilindros
Junta Cabeçote



2723400 - 0348Q2
Guarnición caja de admisión
Guarnição caixa de admissão



JAE-500-A
Juego Admisión
Jogo Admissão



2723300
Anillo termostato con ranura
Anel termostato com ranhura



JAE-498-E - 0347K1
Junta Escape
Junta Escapamento



JAE-499-E
Junta Escape
Junta Escapamento



RT-8796Pol
Retén Árbol de Levas
Ret. do Eixo Comando de Válv.
36,00 x 50,00 x 7,00



RT-614Pol
Jgo. Ret. Guía Válvulas
Jogo Retentor da Haste de Válvulas

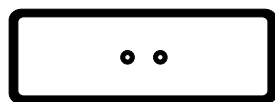

JVS-271-43 - 024954
Junta Tapa Válvula Superior c/arruelas
Junta Tampa Válvula Superior c/arruelas



1092300
Brida cuadrada
Flange quadrada



2723700
Conjunto guar. bomba de aceite
(Aro silicone - Buje)
Conjunto bomba óleo
(Aro silicone - Bucha)
10,8 x 15 x 4mm



1092400
Brida chica
Flange pequena



JC-325-26 - 030430
Junta Cártér
Junta Carter



2723500
Arandela bulbo presión
(Goma-metal)
Arruela bulbo pressão
(Borracha-metal)



RT-9196Vit
Retén Bancada
Ret. Traseiro do Virabrequim
Lx-R 85,00 x 105,00 x 8,00



RT-9192Pol
Retén Distribución
Ret. Diant. do Virabrequim
Lx-R 42,00 x 66,00 x 8,00



2745200
Juego arandela camisa (Silicona)
Jogo arruela camisa (Silicone)

2727000 - Juego Arandelas de Goma/Jogo Arruelas de Borracha

Gráfico	Descripción/Descrição	Cant./Quant.
	O'ring 73,3x3mm tapón bomba de agua	1
	O'ring 57x2,5mm cubo bomba de agua	1
	O'ring 36,5x3,1mm	1

Productos relacionados no incluidos en el juego. Los mismos pueden ser solicitados por separado.

Produtos relacionados não incluídos no jogo. Podem ser solicitados em separado.

Related products that were not included in the set but can be ordered separately.



BU-033
Bulones para Culata de Cilindros
Parafusos de Cabeçote



JSA-277-21
Salida Escape (Anillo Malla Acero)
Saída Escapamento
(Anel Malha Aço)

DESCRIPCIÓN / Descrição / Description **DIESEL**

PEUGEOT: 208
CITROEN: C3 III 8V

MOTOR / Engine	CM ³	HP	Ø PISTON
DV4C (8HP/8HR)	1398	68	73.70

Juego Completo de Reparación:

Jogo de Juntas do Motor / Full Set Gasket:

JR-796-11

Semi-Juego de Reparación:

Semi-Jogo de Juntas / Semi-Set Gasket:

SJ-796

Juego de Descarbonización:

Jogo de Juntas Superior / Head Set Gasket:

JUNTA CULATA DE CILINDROS	TC-809-11	Ø 74.70mm	1.25mm	↑ ↓
Junta de cabeçote				↑ ↓
Cylinder Head gasket				↑ ↓

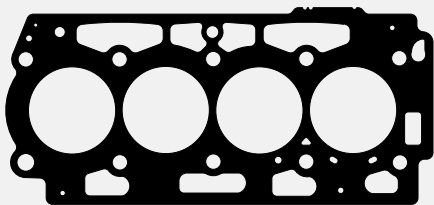

TC-809-11 - 0209HH/9684555380
Junta Culata de Cilindros
Junta Cabeçote



1402400 - 1206E2
Bomba de agua
Bomba de água



JAE-299-E - 0349N9
Junta Escape
Junta Escapamento



JVS-293-43 - 0249G2
Junta Tapa Válvula Superior
Junta Tampa Válvula Superior

Productos relacionados no incluidos en el juego. Los mismos pueden ser solicitados por separado.

Produtos relacionados não incluídos no jogo. Podem ser solicitados em separado.

Related products that were not included in the set but can be ordered separately.

Juego Completo de Reparación:

Jogo de Juntas do Motor / Full Set Gasket:

JR-778**R****Semi-Juego de Reparación:**

Semi-Jogo de Juntas / Semi-Set Gasket:

SJ-778**R****Juego de Descarbonización:**

Jogo de Juntas Superior / Head Set Gasket:

JD-778**R**

JUNTA CULATA DE CILINDROS Junta de cabeçote Cylinder Head gasket	TC-954-15	∅ 76.00mm	1.50mm	↑ ↓
	TC-954-MG	∅ 76.00mm	1.50mm	↑ ↓

DESCRIPCIÓN / Descrição / Description

PEUGEOT: 208 Active/Allure 2013/...
CITROEN: C3 Picasso 2013/...

MOTOR / Engine	CM ³	HP	∅ PISTON
TU4 8V	1450	90	75.00

ILLINOIS

PEUGEOT

**JD-778****TC-954 - 02091E**
Junta Culata de Cilindros
Junta Cabeçote**2723400 - 0348Q2**
Guarnición caja de admisión
Guarnição caixa de admissão**JAE-500-A**
Juego Admisión
Jogo Admissão**2723300**
Anillo termostato con ranura
Anel termostato com ranhura**JAE-498-E - 0347K1**
Junta Escape
Junta Escapamento**JAE-499-E**
Junta Escape
Junta Escapamento**RT-8796Pol**
Retén Árbol de Levas
Ret. do Eixo Comando de Válvulas
36,00 x 50,00 x 7,00**RT-614Pol**
Jgo. Ret. Guía Válvulas
Jogo Retentor da Haste de Válvulas**JVS-271-43 - 024954**
Junta Tapa Válvula Superior c/arruelas
Junta Tampa Válvula Superior c/arruelas**1092300**
Brida cuadrada
Flange quadrada**JC-325-26 - 030430**
Junta Cártel
Junta Carter**1092400**
Brida chica
Flange pequena**2723700**
Conjunto guar. bomba de aceite
(Aro silicona - Buje)
Conjunto bomba óleo
(Aro silicone - Bucha)
10,8 x 15 x 4mm**2745200**
Juego arandela camisa (Silicona)
Jogo arruela camisa (Silicone)**2723500**
Arandela bulbo presión
(Goma-metal)
Arruela bulbo pressão
(Borracha-metal)**2778400 - Juego Arandelas de Goma/Jogo Arruelas de Borracha**

Gráfico	Descripción/Descrição	Cant./Quant.
	O'ring 73,3x3mm	1
	O'ring 69,52x2,62mm	1
	O'ring 57x2,5mm 36,5x3,1mm	1
	O'ring 57x3mm	2
	Arandela/Arruela 55x59x4,5mm	2
	Arandela/Arruela 45x49x5mm	1
	O'ring 36,5x3,1mm	2
	O'ring 26,57x3,53mm	4
	O'ring 20x3mm	4

**RT-6863Vit**
Retén Bancada
Ret. Traseiro do Virabrequim
Lx-R 85,00 x 105,00 x 12,00**RT-9192Pol**
Retén Distribución
Ret. Dianteiro do Virab.
Lx-R 42,00 x 66,00 x 8,00

Productos relacionados no incluidos en el juego. Los mismos pueden ser solicitados por separado.

Produtos relacionados não incluídos no jogo. Podem ser solicitados em separado.

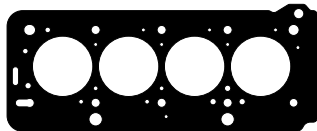
Related products that were not included in the set but can be ordered separately.

**BU-033**
Bulones para Culata de Cilindros
Parafusos de Cabeçote**JSA-277-21**
Salida Escape (Anillo Malla Acero)
Saída Escapamento (Anel Malha Aço)

DESCRIPCIÓN / Descrição / Description **DIESEL**

PEUGEOT: 106 1994/...
CITROEN: AX 15 1994/97 - Saxo 1996/...
NISSAN: Micra 1997/...
ROVER: 115TD 1995/98

MOTOR / Engine	CM ³	HP	Ø PISTON
TUD5 (VJY)	1527	55/58	77.00
TUD5 (VJZ)	1527	55/58	77.00

Juego Completo de Reparación:

Jogo de Juntas do Motor / Full Set Gasket:

JR-489-20

R

Semi-Juego de Reparación:

Semi-Jogo de Juntas / Semi-Set Gasket:

SJ-489

R

Juego de Descarbonización:

Jogo de Juntas Superior / Head Set Gasket:

JD-489-20

R

JUNTA CULATA DE CILINDROS	TC-438-20	Ø 78.50mm	1.80mm	1.80mm
Junta de cabeçote				
Cylinder Head gasket				



JD-489-20

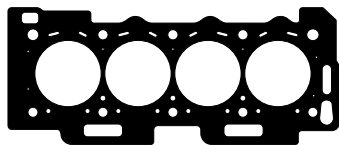

TC-438-20 - 0209T8
 Junta Culata de Cilindros
 Junta Cabeçote



JAE-418-E - 0349E4
 Junta Escape
 Junta Escapamento



JVS-317-43 - 024993
 Junta Tapa Válvula Superior
 Junta Tampa Válvula Superior



JSA-259 - 170910
 Salida Escape
 Saída Escapamento



JC-325-26 - 030430
 Junta Cáster
 Junta Carter



RT-6863Vit
 Retén Bancada
 Retentor Traseiro do Virabrequim
 Lx-R 85,00 x 105,00 x 12,00



RT-9192Pol
 Retén Distribución
 Ret. Dianteiro do Virabrequim
 Lx-R 42,00 x 66,00 x 8,00

2739300 - Juego Arandelas de Goma/Jogo Arruelas de Borracha

Gráfico	Descripción/Descrição	Cant./Quant.
	O'ring 47,3x2mm	1
	Termostato	1
	Arandela goma 11x15x3mm	8
	O'ring 9,2x2,62mm	1

2605400 - Juego Arandelas Metálicas/Jogo Arruelas Metálicas

Gráfico	Descripción/Descrição	Cant./Quant.
	Aran./Arruela 17x20x1,5mm Cobre	4
	Aran./Arruela 12x18x1,5mm Cobre	3
	Aran./Arruela 10x16x2,5mm Cobre	2
	Aran./Arruela 7x13x1,5mm Cobre	8
	Aran./Arruela 6x14mm Acero	4



RT-8796Pol
 Retén Árbol de Levas
 Retentor do Eixo Comando de Válvulas
 A156-R 36,00 x 50,00 x 7,00



RT-576Pol
 Jgo. Ret. Guía Válvulas
 Jogo Ret. haste Válvulas

2605900 - Juego Arandelas Metálicas/Jogo Arruelas Metálicas

Gráfico	Descripción/Descrição	Cant./Quant.
	Aran./Arruela 22x29x3mm Aluminio	3
	Aran./Arruela 18x23x1mm Cobre	1
	Aran./Arruela 14x22x2mm Cobre	2
	Ar./Arru. blindada 14x18x2,5mm Cobre	1
	Aran./Arruela 10x18x2mm Aluminio	1
	Aran./Arruela 12x17x2mm Cobre	4

2755500 - Juego Arandelas de Goma/Jogo Arruelas de Borracha

Gráfico	Descripción/Descrição	Cant./Quant.
	O'ring 74x3mm	1
	O'ring 37,7x2,6mm	1
	O'ring 7,59x2,62mm	1

Productos relacionados no incluidos en el juego. Los mismos pueden ser solicitados por separado.

Produtos relacionados não incluídos no jogo. Podem ser solicitados em separado.

Related products that were not included in the set but can be ordered separately.



BU-200
 Bulones para Culata de Cilindros
 Parafusos de Cabeçote

Juego Completo de Reparación:

Jogo de Juntas do Motor / Full Set Gasket:

JR-786-11**Semi-Juego de Reparación:**

Semi-Jogo de Juntas / Semi-Set Gasket:

SJ-786**Juego de Descarbonización:**

Jogo de Juntas Superior / Head Set Gasket:

JUNTA CULATA DE CILINDROS	TC-895-11	∅ 76.30mm	1.25mm	↑ ↓
Junta de cabeçote				↑ ↓
Cylinder Head gasket				↑ ↓

DESCRIPCIÓN / Descrição / Description

DIESEL**PEUGEOT:** Partner**CITROEN:** Berlingo - C4 - C-Elysee

MOTOR / Engine	CM ³	HP	∅ PISTON
DV6DTEd (9HF/HJ/HP)	1560	90	75.00

ILLINOIS

PEUGEOT

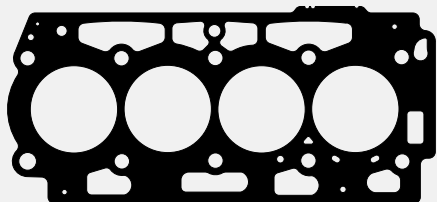

TC-895-11 - 9676157680/0209JF/JN
Junta Culata de Cilindros
Junta Cabeçote



1402400 - 1206E2
Bomba de agua
Bomba de água



JAE-299-E - 0349N9
Junta Escape
Junta Escapamento



JVS-293-43 - 0249G2
Junta Tapa Válvula Superior
Junta Tampa Válvula Superior

Productos relacionados no incluidos en el juego. Los mismos pueden ser solicitados por separado.

Produtos relacionados não incluídos no jogo. Podem ser solicitados em separado.

Related products that were not included in the set but can be ordered separately.

DESCRIPCIÓN / Descrição / Description

PEUGEOT: 305 GTX - 306 - 309 GT- 405 1987/93
CITROEN: BX19 1984/93 - BX16 1985/90
 BX16 GTI 1991/93

MOTOR / Engine	CM ³	HP	Ø PISTON
XU5CP - XU5M	1580	75/105	83.00
XU9M	1905	98	83.00
XU92C/5	1905	96/125	83.00
XU9J1/J2	1905	102	83.00

Juego Completo de Reparación:

Jogo de Juntas do Motor / Full Set Gasket:

JR-370



Semi-Juego de Reparación:

Semi-Jogo de Juntas / Semi-Set Gasket:

SJ-278



Juego de Descarbonización:

Jogo de Juntas Superior / Head Set Gasket:

JD-176



JUNTA CULATA DE CILINDROS	TC-616-15	Ø 84.30mm	1.50mm
Junta de cabeçote	TC-616-MG	Ø 84.30mm	1.50mm
Cylinder Head gasket	TC-616-18	Ø 84.30mm	2.30mm

JD-176

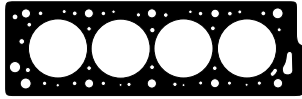

TC-616 - 0209E10/020489
 Junta Culata de Cilindros
 Junta Cabeçote



JSA-214 - 1710390
 Salida Escape
 Saída Escapamento



1178500
 Base carburador
 Base carburador



2739600 - 1339530
 O'ring termostato



JAE-382-A - 0348910
 Junta Admisión
 Junta Admissão



JAE-384-A - 0348780
 Junta Admisión
 Junta Admissão



1160800 - 0147120
 21011008081
 Cuerpo de termostato
 Corpo termostato



RT-613Pol
 Juego Retenes
 Guia de Válvulas
 Jogo Retentor da Haste
 de Válvulas

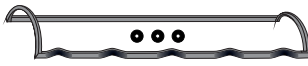

JVS-260-43 - 0249480
 Junta Tapa Válvula Superior
 c/ arandelas
 Junta Tampa Válvula Superior



JAE-383-E - 21011002064
 0349700
 Juego Escape
 Jogo Escapamento



1178100 - 1339410
 Alojamiento termostato
 Alojamento termostato



RT-8796Pol
 Retén Árbol de Levas
 Ret. do Eixo Comando de Válv.
 Lx-Hel 36,00 x 50,00 x 7,00



JC-304-26 - 0304340/21011003070
 Junta Carter
 Junta Carter



2739400
 O'ring 19,5 x 2,5mm



1178400 - 1451070
 Bomba de nafta
 Bomba de gasolina



2745300 - 0112780
 Juego arandelas camisa
 (Silicona)
 Jogo arruelas camisa
 (Silicone)



1160600 - 1206460
 21011307046
 Bomba de agua
 Bomba de água



2711500 - 0127050
 Clavito bancada (Sección circular)
 Bastão traseiro virabrequim
 (Seção circular)



1178200 - 1339790
 Colector tubo de agua
 Coletor tubo água



1178000 - 0310040/0164300
 Junta alojamiento termostato
 Junta alojamento termostato



2739800
 O'ring distribución
 distribuição
 36,5 x 3,1mm

2629200 - Juego Arandelas Metálicas/Jogo Arruelas Metálicas

Gráfico	Descripción/Descrição	Cant./Quant.
	Aran./Arruela 22,5x29x2mm Aluminio	2
	Ar./Arru. blindada 16x22x2,5mm Cobre	4
	Ar./Arruela 14x22x1,5mm Aluminio	1
	Aran./Arruela 6x11x2mm Aluminio	4



RT-9191Vit
 Retén Bancada
 Retentor Traseiro do Virabrequim
 Lx-R 90,00 x 110,00 x 7,00



RT-8510Pol
 Retén Distribución
 Ret. Dianteiro do Virabrequim
 Lx-R 42,00 x 62,00 x 8,00

Productos relacionados no incluidos en el juego. Los mismos pueden ser solicitados por separado

Produtos relacionados não incluídos no jogo. Podem ser solicitados em separado / Related products that were not included in the set but can be ordered separately.



BU-028
BU-031
BU-032
 Bul. p/Cul. de Cilindros
 Parafusos de Cabeçote



JV-156
 Jgo. Caja Vel.
 Jogo Caixa de
 Câmbio



JB-219
 Jgo.
 Carburador



JSA-270-21
 Salida Escape
 Saída Escap.



JC-304-15
 Junta Carter
 Junta Carter



1164500
 Resonador
 Ressonador



JAE-438-A
 Jgo. Admisión/
 Admissão



JAE-383-09
 Jgo. Escape/
 Escapamento

Juego Completo de Reparación:

Jogo de Juntas do Motor / Full Set Gasket:

JR-511**Semi-Juego de Reparación:**

Semi-Jogo de Juntas / Semi-Set Gasket:

SJ-511**Juego de Descarbonización:**

Jogo de Juntas Superior / Head Set Gasket:

JD-511

JUNTA CULATA DE CILINDROS Junta de cabeçote Cylinder Head gasket	TC-785-15	∅ 80.00mm	1.50mm	↑ ↓
	TC-785-MG	∅ 80.00mm	1.50mm	↑ ↓
	TC-785-18	∅ 80.00mm	2.30mm	↑ ↓

DESCRIPCIÓN / Descrição / Description

PEUGEOT: 206 - 307 - Partner 2000/...
207 SW - 207 Compact
CITROEN: Berlingo - C3 Pluriel - Xsara 2000/...
C2 - C3 2002/...

MOTOR / Engine	CM ³	HP	∅ PISTON
TU5JP4 (NFU/N6A) 16V	1587	109	78.50

ILLINOIS

PEUG. / CITROEN

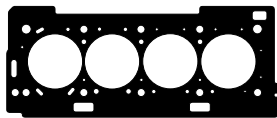
**JD-511**

TC-785 - 02091E/9804548280
Junta Culata de Cilindros
Junta Cabeçote



JAE-506-A - 034895
Juego Admisión
Jogo Admissão



1092300
Junta brida cuadrada
Junta flange quadrada

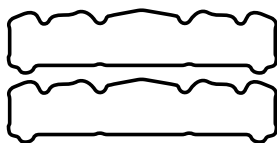

JVS-302-43 - 0249A9
Junta Tapa Válvula Superior
Junta Tampa Válvula Superior



JAE-505-E - 0341G2
Junta Escape
Junta Escapamento



RT-581PoI
Juego Retenes
Guía de Válvulas
Jogo Retentor
Haste de Válvulas

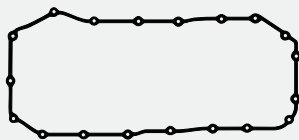

JC-336-43 - 0304C5
Junta Cártel
Junta Carter



2711500 - 21081107990
Clavito bancada
(Sección circular)
Bastão traseiro virabrequim
(Seção circular)



RT-8399PoI
Retén Árbol de Levas
Retentor do Eixo Comando
de Válvulas
38,00 x 50,00 x 6,00



2611000
Arandela chica radiador
de aceite
Arruela pequena radiador
de óleo



2723500
Arandela bulbo presión
Arruela bulbo pressão
(Goma/Borracha-metal)



2724600
Junta carga aceite
Junta abastecimento óleo

2727200 - Juego Arandelas Goma/Jogo Arruelas Borracha

Gráfico	Descripción/Descrição	Cant./Quant.
	O'ring 74x3mm anillo/anel bomba agua	1
	O'ring 45x4mm anillo/anel termostato	1
	O'ring 37,7x2,6mm distrib. agua	1
	O'ring 7,52x3,53mm inyección/injeção	1



RT-6863Vit
Retén Bancada
Retentor Traseiro do Virabrequim
Lx-R 85,00 x 105,00 x 12,00



RT-9192PoI
Retén Distribución
Retentor Dianteiro do Virabrequim
Lx-R 42,00 x 66,00 x 8,00

Productos relacionados no incluidos en el juego. Los mismos pueden ser solicitados por separado.

Produtos relacionados não incluídos no jogo. Podem ser solicitados em separado.

Related products that were not included in the set but can be ordered separately.



BU-223
Bulones para
Culata de Cilindros
Parafusos de Cabeçote



JSA-277-21
Salida Escape (An. Malla Acero)
Saída Escapamento
(Anel Malha Aço)



JVS-398-43
Junta Tapa de Válvula
Junta Tampa de Válvula
(Plástica)

DESCRIPCIÓN / Descrição / Description

PEUGEOT: 106 1994/... - 306 1993/...
206 1998/...
CITROEN: ZX - Saxo 1996/... - Xsara 1997/...

MOTOR / Engine	CM ³	HP	Ø PISTON
TU5JP/J2	1587	90/103	78.50

Juego Completo de Reparación:

Jogo de Juntas do Motor / Full Set Gasket:

JR-515

R

Semi-Juego de Reparación:

Semi-Jogo de Juntas / Semi-Set Gasket:

SJ-515

R

Juego de Descarbonización:

Jogo de Juntas Superior / Head Set Gasket:

JD-515

R

JUNTA CULATA DE CILINDROS	TC-787-15	Ø	80.00mm	∓	1.50mm	∓
Cilindros	TC-787-MG	Ø	80.00mm	∓	1.50mm	∓
Junta de cabeçote	TC-787-18	Ø	80.00mm	∓	2.30mm	∓
Cylinder Head gasket		Ø		∓		∓



JD-515

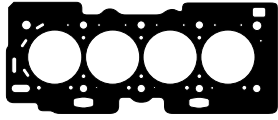

TC-787 - 0209F6
Junta Culata de Cilindros
Junta Cabeçote



JSA-267
Salida Escape
Saída Escapamento

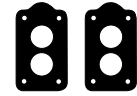

1178500
Base carburador
Base carburador



JAE-428-E
Juego Escape
Jogo Escapamento



JAE-495-A
Juego Admisión
Jogo Admissão



2706500 - 21011005155
1340480
Guarnición termostato
Guarnição termostato
47 x 53 x 4,6mm



JVS-271-43 - 024954
Junta Tapa Válvula Superior
c/arruelas
Junta Tampa Válvulas Sup. c/arruelas



RT-8796Pol
Retén Árbol de Levas
Retentor do Eixo Comando de Válvulas
A156-R 36,00 x 50,00 x 7,00



RT-614Pol
Jgo. Ret. Guía Válvulas
Jogo Retentor da Haste de Válvulas



JC-353-26
Junta Cártter
Junta Carter

2624700 - Juego Arandelas Metálicas/Jogo Arruelas Metálicas

Gráfico	Descripción/Descrição	Cant./Quant.
○	Aran./Arruela 22x30x2mm Cobre	3
○	Aran./Arruela 18x22x1,5mm Cobre	2
○	Ar./Arruela 12x18x1,5mm Aluminio	1



2725900
O'ring 75,9 x 2,6mm



2740400
O'ring 36,2 x 2,6mm



RT-9196Vit
Retén Bancada
Retentor Traseiro do Virabrequim
Lx-R 85,00 x 105,00 x 8,00



RT-9192Pol
Retén Distribución
Ret. Dianteiro do Virabrequim
Lx-R 42,00 x 66,00 x 8,00

Productos relacionados no incluidos en el juego. Los mismos pueden ser solicitados por separado.

Produtos relacionados não incluídos no jogo. Podem ser solicitados em separado.

Related products that were not included in the set but can be ordered separately.



BU-033
Bulones para
Culata de Cilindros
Parafusos de Cabeçote



JSA-277-21
Salida Escape (Anillo Malla Acero)
Saída Escapamento
(Anel Malha Aço)

Juego Completo de Reparación:

Jogo de Juntas do Motor / Full Set Gasket:

JR-571**Semi-Juego de Reparación:**

Semi-Jogo de Juntas / Semi-Set Gasket:

SJ-571**Juego de Descarbonización:**

Jogo de Juntas Superior / Head Set Gasket:

JD-571

JUNTA CULATA DE CILINDROS	TC-684-15	∅ 78.20mm	∓ 1.00mm	∓ 0.05mm
Junta de cabeçote	TC-684-MG	∅ 78.20mm	∓ 1.00mm	∓ 0.05mm
Cylinder Head gasket				

DESCRIPCIÓN / Descrição / Description

PEUGEOT: 207/CC - 208 2012/... - 308/SW 2007/...

508/SW/RCZ 2010/... - 3008 2009/...

CITROEN: C4/Picasso/Grand Picasso 2008/...

C5/Tourer 2009/... - DS3 2010/...

MOTOR / Engine	CM ³	HP	∅ PISTON
EP6DT (5FX/5FR)	1598	150/156	77.00
EP6DT (5FV/5FT)	1598	150/163	77.00
EP6CDT (5F04)	1598	156	77.00
EP6DTS (5FY)	1598	156	77.00

ILLINOIS

PEUG. / CITROEN

JD-515

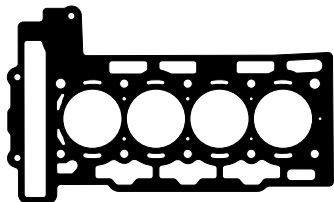

TC-684 - 0209ER/9803673380/
11127560276/11127586907
Junta Culata de Cilindros
Junta Cabeçote



JAE-640-A - 0348S9
Múltiple Admisión
Coletor Admissãõ



2778700
Guarnición goma
Guarnição borracha

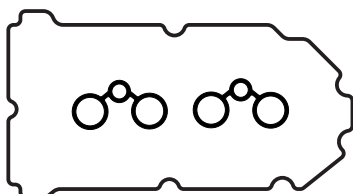

JVS-418-43 - 9805264280
Junta Tapa de Válvula Superior
Junta Tampa de Válvulas Superior



JAE-641-E - 1723AZ/V761689580
Junta Escape
Junta Escapamento



RT-2969Vit
Juego Ret. Guía de Vál.
Jogo Retentor da Haste
de Válvulas

2638600
Arandela
Arruela (Cobre)
11 x 21,5 x 2 mm

2638700
Arandela
Arruela (Aluminio)
13,5 x 24,5 x 1,5mm

2617600
Arandela
Arruela (Cobre)
16 x 22 x 1,5mm

2760600
O'ring 72,62 x 3,53 mm

2778600 - 1206E8
Bomba de agua
Bomba d'água

2768600
O'ring 34,59 x 2,62 mm

Retén Distribución
Retentor Dianteiro do Virabrequim
Lx-Hel 61,00 x 75,00 x 8,00

RT-9196Vit
Retén Bancada
Retentor Traseiro do Virabrequim
Lx-Hel 85,00 x 105,00 x 8,00

2778500
Guarnición goma
Guarnição borracha

Productos relacionados no incluidos en el juego. Los mismos pueden ser solicitados por separado.

Produtos relacionados não incluídos no jogo. Podem ser solicitados em separado.

Related products that were not included in the set but can be ordered separately.

DESCRIPCIÓN / Descrição / Description

PEUGEOT: 404 - 504 1962/80
(0199421/0199414)

MOTOR / Engine CM³ HP Ø PISTON

XC7 1618 59 84.00

Juego Completo de Reparación:

Jogo de Juntas do Motor / Full Set Gasket:

JR-199-15

R

Semi-Juego de Reparación:

Semi-Jogo de Juntas / Semi-Set Gasket:

Juego de Descarbonización:

Jogo de Juntas Superior / Head Set Gasket:

JD-111-15

R

JUNTA CULATA DE CILINDROS	TC-358-15	Ø 87.00mm	1.60mm	±0.05
Junta de cabeçote	TC-358-18	Ø 87.00mm	2.50mm	±0.05
Cylinder Head gasket				



JD-111-15

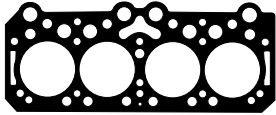

TC-358-15 - 0203240
Junta Culata de Cilindros
Junta Cabeçote



JSA-149 - 1710100
Salida Escape
Saída Escapamento



JAE-261-A - 0348181
Junta Admisión
Junta Admissão



JAE-260-09 - 0349030
Juego Escape
Jogo Escapamento



JSA-148 - 1710070
Salida Escape
Saída Escapamento



1070900 - 1206080
Bomba de agua
Bomba de água

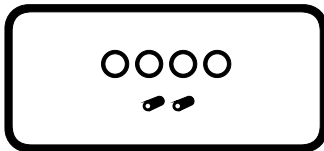

JVS-208-43 - 0249140
Junta Tapa Vál. Sup. c/bujes y arandelas
Junta Tampa Vál. Sup. c/bucha y arruelas

2620800 - Juego Arandelas Metálicas/Jogo Arruelas Metálicas

Gráfico	Descripción/Descrição	Cant./Quant.
	Aran./Arruela 18x24x2,5mm Cobre	1
	Aran./Arruela 16x22x2,5mm Cobre	1
	Aran./Arruela 8x14x1mm Aluminio	4



RT-513Pol
Jgo. Ret. Guía Válvulas
Jogo Retentor da Haste de Válvulas

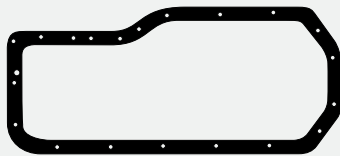

JC-119-30 - 0304030
Junta Carter
Junta Carter



1069900 - 0321110
Tapa distribución
Tampa distribuição



1070000 - 0322040
Contratapa distribución
Contra-tampa distribuição

2709400 - 1031030
Bomba de aceite
Bomba de óleo
O'ring 12,42 x 1,78mm



1071000 - 1451030
Bomba de nafta
Bomba de gasolina



1070400 - 5907001
Base distribuidor
Base distribuidor



1070100 - 0348060
Codo admisión
Cotovelo admissão



1070700 - 1120010
Caño respiración
Tubo respiro



1070500 - 1104040
Bomba de aceite
Bomba de óleo



2711500 - 0127050
Clavito bancada
(Sección circular)
Bastão traseiro virabrequim
(Seção circular)



1070600 - 1115020
Filtro aceite
Filtro óleo



1071100 - 6462100
Grifo calefactor
Torneira aquecedor



RT-6687Pol
Retén Retentor
A 156-R 42,00 x 60,00 x 10,00

Productos relacionados no incluidos en el juego. Los mismos pueden ser solicitados por separado
Produtos relacionados não incluídos no jogo. Podem ser solicitados em separado / Related products that were not included in the set but can be ordered separately.



BU-026
Bul. p/Cul. de Cilindros
Parafusos de Cabeçote



JB-174
Jgo. Carburador



1086000
Jgo. Diferencial



1131400 - 0321110
Tapa Distribución
Tampa Distribuição



2744300
Jgo. Arandelas/Arruelas
Camisa (Sintético)(Jgo. x 4)



JC-119-26 - (1,5mm)
JC-119-23
Junta Carter

Juego Completo de Reparación:

Jogo de Juntas do Motor / Full Set Gasket:

JR-385**Semi-Juego de Reparación:**

Semi-Jogo de Juntas / Semi-Set Gasket:

SJ-385**Juego de Descarbonización:**

Jogo de Juntas Superior / Head Set Gasket:

JD-385

JUNTA CULATA DE CILINDROS	TC-616-15	∅ 84.30mm	1.50mm	±0.05
Junta de cabeçote	TC-616-MG	∅ 84.30mm	1.50mm	±0.05
Cylinder Head gasket	TC-616-18	∅ 84.30mm	2.30mm	±0.05

DESCRIPCIÓN / Descrição / Description

PEUGEOT: 306 1993/... - 405 - 406 1992/... - 806 Expert 1996/... - Partner 1996/...
CITROEN: Xsara 1997/... - Xantia 1997/01 - Evasion Synergie - ZX 1992/98 - Berlingo 1997/...

MOTOR / Engine	CM ³	HP	∅ PISTON
XU7 JP/Z 8V	1761	98/101	83.00
XU7 JB 8V	1761	90/103	83.00

ILLINOIS

PEUG. / CITROEN

JD-385



TC-616 - 0209E10/020489
Junta Culata de Cilindros
Junta Cabeçote



JAE-473-A - 0348F60
Juego Admisión
Jogo Admissão



JAE-383-E - 21011002064/0349700
Juego Escape
Jogo Escapamento



JAE-468-E - 1723630
Junta Escape
Junta Escapamento



JAE-426-A - 21051002064
Juego Admisión
Jogo Admissão



RT-613PoI
Juego Ret. Guía de Válvulas
Jogo Retenedor da Haste de Válvulas



JVS-273-43 - 024971
Junta Tapa Válvula Superior c/arandelas
Junta Tampa Válvula Superior c/arruelas



2711600 - 21011106170
O'ring 4,47 x 1,78mm



RT-8796PoI
Retén Árbol de Levas
Retenedor do Eixo Comando de Válvulas
Lx-Hel 36,00 x 50,00 x 7,00



JC-304-26 - 0304340
21011003070
Junta Carter
Junta Carter

2706500 - 1340480
21011005155
Guarnición termostato
Guarnição termostato
47 x 53 x 4,6mm

2619600 - Juego Arandelas Metálicas/Jogo Arruelas Metálicas

Gráfico	Descripción/Descrição	Cant./Quant.
	Aran./Arruela 18x24x2mm Cobre	1
	Ar./Arr. blindada 16x22x2,5mm Cobre	1
	Aran./Arruela 15x20x1mm Cobre	1
	Ar./Arr. blindada 14x18x2,5mm Cobre	1
	Aran./Arruela 12x18x3mm Cobre	1
	Aran./Arruela 8x12x1mm Cobre	4
	Aran./Arruela 7x11x1mm Cobre	4



2745300 - 0112780
Juego arandelas camisa (Silicona)
Jogo arruelas camisa (Silicone)



JSA-263-21 - 0365260
Salida Escape
Saída Escapamento
(Fundición/Ferro)



2711400 - 0365260
Anillo caja mariposa admisión
Anel caixa borboleta admissão



2711500 - 21081107990
Clavito bancada
Bastão traseiro virabrequim
(Sección/Seção circular)



1160600 - 1206460
21011307046
Bomba de agua
Bomba de água



1160800 - 0147120
21011008081
Cuerpo termostato
Corpo termostato



RT-9191Vit
Retén Bancada
Retenedor Traseiro do Virabrequim
Lx-R 90,00 x 110,00 x 7,00



RT-8510PoI
Retén Distribución
Retenedor Dianteiro do Virabrequim
Lx-R 42,00 x 62,00 x 8,00

Productos relacionados no incluidos en el juego. Los mismos pueden ser solicitados por separado
 Produtos relacionados não incluídos no jogo. Podem ser solicitados em separado / Related products that were not included in the set but can be ordered separately.



BU-031
BU-032
Bul. p/Cul. de Cilindros
Parafusos de Cabeçote



JC-304-15 - 0304340
21011003070
Junta Carter
Junta Carter



JVS-273-46 - 2101003270
Junta Tapa/Tampa Vál. Sup.
c/arandelas/arruelas
(Silicona/Silicone)



JAE-383-09
21011002064/0349700
Juego Escape
Jogo Escapamento



JSA-263-21 - 0365260
Salida Escape
(Anillo Malla Acero)
Saída Escapamento
(Anel Malha Aço)

DESCRIPCIÓN / Descrição / Description

PEUGEOT: Partner 1996/...
CITROEN: Berlingo 1997/... - Xantia - Xsara

MOTOR / Engine CM³ HP Ø PISTON

XU7JB 1761 90 83.00

Juego Completo de Reparación:

Jogo de Juntas do Motor / Full Set Gasket:

JR-387

R

Semi-Juego de Reparación:

Semi-Jogo de Juntas / Semi-Set Gasket:

SJ-387

R

Juego de Descarbonización:

Jogo de Juntas Superior / Head Set Gasket:

JD-387

R

JUNTA CULATA DE CILINDROS Junta de cabeçote Cylinder Head gasket	TC-616-15	Ø 84.30mm	1.50mm	
	TC-616-MG	Ø 84.30mm	1.50mm	
	TC-616-18	Ø 84.30mm	2.30mm	



JD-387



TC-616 - 0209E10/020489
Junta Culata de Cilindros
Junta Cabeçote



RT-613Pol
Jgo. Ret. Guia Válvulas
Jogo Retentor da Haste de Válvulas



RT-8796Pol
Retén Árbol de Levas
Ret. do Eixo Comando de Válv.
Lx-Hel 36,00 x 50,00 x 7,00



JAE-472-A - 0348263
Juego Admisión
Jogo Admissão



JAE-468-E - 1723630
Junta Escape
Junta Escapamento



2706500 - 21011005155/1340480
Guarnición termostato
Guarnição termostato



JVS-273-43 - 024971
Junta Tapa Válvula Superior
c/arandelas (Sintético)
Junta Tampa Válvula Superior
c/arruelas (Sintético)



2711400 - 0365260
Anillo caja mariposa admisión
Anel caixa borboleta admissão

2620100 - Juego Arandelas Metálicas/Jogo Arruelas Metálicas

Gráfico	Descripción/Descrição	Cant./Quant.
	Ar./Arruela 18x23x1mm Cobre	1
	Ar./Arr. blindada 16x22x2,5mm Cobre	1
	Ar./Arruela 15x20x1mm Cobre	1
	Ar./Arr. blindada 14x18x2,5mm Cobre	1
	Ar./Arruela 12x18x3mm Cobre	1
	Ar./Arruela 8x12x1mm Cobre	4



JC-304-26 - 0304340/21011003070
Junta Cártier
Junta Carter



2745300 - 0112780
Juego arandelas camisas
Jogo arruelas camisas
(Silicona/Silicone)



1160600 - 1206460/21011307046
Bomba de agua
Bomba de água



2711600 - 21011106170
O'ring 4,47 x 1,78mm



JSA-263-21 - 0365260
Salida Escape (Fundición)
Saída Escapamento (Ferro)



2711500 - 21081107990
Clavito bancada
Bastão traseiro virabrequim
(Seccion/Seção circular)



1160800 - 0147120/21011008081
Cuerpo de termostato
Corpo de termostato



RT-9191Vit
Retén Bancada
Ret. Traseiro do Virabrequim
Lx-R 90,00 x 110,00 x 7,00



RT-8510Pol
Retén Distribución
Ret. Dianteiro do Virabrequim
Lx-R 42,00 x 62,00 x 8,00

Productos relacionados no incluidos en el juego. Los mismos pueden ser solicitados por separado.

Produtos relacionados não incluídos no jogo. Podem ser solicitados em separado.

Related products that were not included in the set but can be ordered separately.



BU-031
BU-032
Bul. p/Culata de Cilindros
Parafusos de Cabeçote



JC-304-15 - 0304340
21011003070
Junta Cártier
Junta Carter



JVS-273-46 - 21011003270
Junta Tapa/Tampa
Válvula Superior c/arandelas
c/arruelas (Silicona/Silicone)



JSA-263-21 - 0365260
Salida Escape (Anillo Malla Acero)
Saída Escapamento (Anel Malha Aço)

Juego Completo de Reparación:

Jogo de Juntas do Motor / Full Set Gasket:

JR-394-15**Semi-Juego de Reparación:**

Semi-Jogo de Juntas / Semi-Set Gasket:

SJ-394**Juego de Descarbonización:**

Jogo de Juntas Superior / Head Set Gasket:

JD-394-15

JUNTA CULATA DE CILINDROS	TC-599-15	∅ 84.00mm	1.50mm	∓
	TC-599-18	∅ 84.00mm	2.30mm	∓
Junta de cabeçote				∓
Cylinder Head gasket				∓

DESCRIPCIÓN / Descrição / Description

PEUGEOT: 306 1997/2003 - 406 1995/2000
CITROEN: Xsara 1997/... - ZX - Xantia 1995/...
 (B197X170)

MOTOR / Engine	CM ³	HP	∅ PISTON
XU7 JP4(LFY) 16V	1761	112	83.00

ILLINOIS

PEUG. / CITROEN

JD-394-15

TC-599 - B209930/0209Q3
 Junta Culata de Cilindros
 Junta Cabeçote



1118600 - 1340330
 Alojamiento termostato
 Alojamento termostato



2723100
 O'ring admisión/admissão



2710300
 Tubo llenado aceite
 Tubo enchimento óleo



2706500 - 1340480
 21011005155
 Guarnición termostato
 Guarnição termostato
 47 x 53 x 4,6mm



JAE-437-A - 0348C8
 Junta Admisión
 Junta Admissão



JAE-409-09 - 0349400/0349F4
 Junta Escape
 Junta Escapamento



JAE-462-A - 0348K6
 Toberas admisión
 Coletor admissão



2614400
 Arandela 6,8 x 13,5 x 1mm
 (aluminio y goma)
 Arruela (alumínio e borracha)

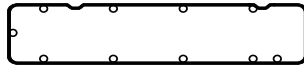

JVS-312-43 - 0249A2
 Junta Tapa Válvula Superior
 Junta Tampa Válvula Superior
 (c/Curva)

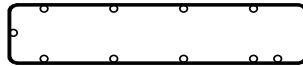

JVS-313-43 - 0249A3
 Junta Tapa Válvula Superior
 Junta Tampa Válvula Superior
 (Recta)



RT-2991Vit - 095645
 Juego Retenes Guía de Válvulas
 Jogo Ret. da Haste de Válvulas
 6,00 x 10,00 x 17,40

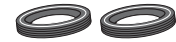

RT-8796Pol
 Retén Árbol de Levas
 Ret. do Eixo Comando de Válvulas:
 Lx-Hel 36,00 x 50,00 x 7,00



JC-304-26 - 0304340/21011003070
 Junta Cáster
 Junta Carter



1160600 - 1206460
 21011307046
 Bomba de agua
 Bomba de água



2711500 - 0127050
 Clavito bancada
 Bastão traseiro virabrequim
 (Sección/Seção circular)



2745300 - 0112780
 Juego arandelas camisa
 Jogo arruelas camisa
 (Silicona/Silicone)



2701900 - 3910824
 O'ring 9,25 x 1,78mm

2620900 - Juego Arandelas Metálicas/Jogo Arruelas Metálicas

Gráfico	Descripción/Descrição	Cant./Quant.
	Aran./Arruela 16x22x1mm Cobre	1
	Aran./Arr. blindada 14x18x2,5mm Cobre	1
	Aran./Arruela 6x10,5x2mm Cobre	1
	Aran./Arruela 6x10x1mm Aluminio	3



RT-9191Vit
 Retén Bancada
 Ret. Traseiro do Virabrequim
 Lx-R 90,00 x 110,00 x 7,00



RT-8510Pol
 Retén Distribución
 Ret. Dianteiro do Virabrequim
 Lx-R 42,00 x 62,00 x 8,00

Productos relacionados no incluidos en el juego. Los mismos pueden ser solicitados por separado.

Produtos relacionados não incluídos no jogo. Podem ser solicitados em separado.

Related products that were not included in the set but can be ordered separately.



BU-034
 Bulones para
 Culata de Cilindros
 Parafusos de Cabeçote



JC-304-15 - 0304340
 21011003070
 Junta Cáster
 Junta Carter

DESCRIPCIÓN / Descrição / Description			
PEUGEOT: 406 1995/00			
CITROEN: Xsara 1997/00			
MOTOR / Engine	CM ³	HP	Ø PISTON
XU7 JP4(LFY) 16V	1761	112	83.00

Juego Completo de Reparación: Jogo de Juntas do Motor / Full Set Gasket:	JR-594-15	R		
Semi-Juego de Reparación: Semi-Jogo de Juntas / Semi-Set Gasket:				
Juego de Descarbonización: Jogo de Juntas Superior / Head Set Gasket:	JD-594-15	R		
JUNTA CULATA DE CILINDROS Junta de cabeçote Cylinder Head gasket	TC-599-15 TC-599-18	Ø 84.00mm Ø 84.00mm	1.50mm 2.30mm	

JD-594-15



TC-599-15 - B209930/0209Q3
Junta Culata de Cilindros
Junta Cabeçote



1118600 - 1340330
Alojamiento termostato
Alojamento termostato



2723100
O'ring admisión
admissão



2706500 - 1340480/21011005155
Guarnición termostato
Guarnição termostato
47 x 53 x 4,6mm



2710300
Tubo llenado aceite
Tubo enchimento óleo



JAE-437-A - 0348C8
Junta Admisión
Junta Admissão



JAE-409-09 - 0349400/0349F4
Junta Escape
Junta Escapamento



JAE-462-A - 0348K6
Toberas admisión
Coletor admissão



2614400
Arandela 6,8 x 13,5 x 1mm
Arruela
(Aluminio y goma/Borracha)

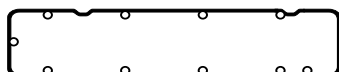

JVS-312-43 - 0249A2
Junta Tapa Válvula Superior
Junta Tampa Válvula Superior
(c/Curva)

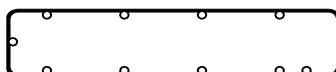

JVS-313-43 - 0249A3
Junta Tapa Válvula Superior
Junta Tampa Válvula Superior
(Recta)



RT-2992Pol - 095642
Juego Retenes Guía de Válvulas
Jogo Retendor da Haste de Válvulas
6,00 x 8,50 x 17,40



RT-8796Pol
Retén Árbol de Levas
Ret. do Eixo Comando de Válvulas
Lx-Hel 36,00 x 50,00 x 7,00



JC-304-26 - 0304340/21011003070
Junta Cáster
Junta Carter



1160600 - 1206460
21011307046
Bomba de agua
Bomba de água

2701900 - 3910824
O'ring 9,25 x 1,78mm



2711500 - 0127050
Clavito bancada
Bastão traseiro virabrequim
(Sección circular)



2745300 - 0112780
Juego arandelas camisa
Jogo arruelas camisa
(Silicona)

2620900 - Juego Arandelas Metálicas/Jogo Arruelas Metálicas

Gráfico	Descripción/Descrição	Cant./Quant.
	Arandela 16x22x1mm Cobre	1
	Arandela blindada 14x18x2,5mm Cobre	1
	Arandela 6x10,5x2mm Cobre	1
	Arandela 6x10x1mm Aluminio	3



RT-9191Vit
Retén Bancada
Retendor Traseiro do Virabrequim
Lx-R 90,00 x 110,00 x 7,00



RT-8510Pol
Retén Distribución
Retendor Dianteiro do Virabrequim
Lx-R 42,00 x 62,00 x 8,00

Productos relacionados no incluidos en el juego. Los mismos pueden ser solicitados por separado.

Produtos relacionados não incluídos no jogo. Podem ser solicitados em separado.

Related products that were not included in the set but can be ordered separately.



BU-034
Bulones para
Culata de Cilindros
Parafusos de Cabeçote



JC-304-15 - 0304340
21011003070
Junta Cáster
Junta Carter

Juego Completo de Reparación:

Jogo de Juntas do Motor / Full Set Gasket:

Semi-Juego de Reparación:

Semi-Jogo de Juntas / Semi-Set Gasket:

Juego de Descarbonización:

Jogo de Juntas Superior / Head Set Gasket:

SJ-259

R

JD-164-ST

R

JUNTA CULATA DE CILINDROS
Junta de cabeçote
Cylinder Head gasket

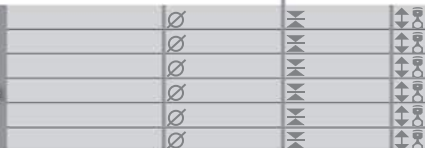

DESCRIPCIÓN / Descrição / Description

DIESEL

PEUGEOT: 205 - 305 - 306 - 309 - 405 - 406 - 806 TD
Expert T/TD - Partner - Boxer TD 1992/...
CITROEN: Xantia TD - ZX TD 1993/... - BX 17TD 1988/92
C15 1994/... - Berlingo 1996/99 - Xsara 1997/...
HYUNDAI: Lantra 1998/.. **LADA:** Niva 2121 - Aleko 1990/..
ROVER: 218 - 418 T/TD 67HP 1991/96
SUZUKI: Vitara 68HP 1995/96 **FIAT:** Ducato TD 1994/...

MOTOR / Engine	CM ³	HP	Ø PISTON	
XUD7 161A/A9A	1	1769	60	80.00
XUD7 T-TE	2	1769	78/90	80.00
XUD9	3	1905	65/69	83.00
XUD9 TE-TF GRD	4	1905	90/92	83.00

ILLINOIS

PEUG. / CITROEN

1

TC-683-20 1M (1.35mm)
TC-683-20 2M (1.40mm)
TC-683-20 3M (1.45mm)
TC-683-20 4M (1.48mm)
TC-683-20 5M (1.60mm)
TC-683-20 6M (1.80mm)
Junta Culata de Cilindros
Junta Cabeçote

2

TC-721-20 2M TC-721-MG 2M (1.65mm)
TC-721-20 3M TC-721-MG 3M (1.80mm)
Junta Culata de Cilindros
Junta Cabeçote

3

TC-643-20 1M TC-643-MG 1M (1.46mm)
TC-643-20 2M TC-643-MG 2M (1.58mm)
TC-643-20 3M TC-643-MG 3M (1.70mm)
TC-643-20 4M TC-643-MG 4M (1.90mm)
TC-643-20 5M TC-643-MG 5M (2.10mm)
Junta Culata de Cilindros
Junta Cabeçote

4

TC-253-20 1M (1.50mm)
TC-253-20 2M (1.60mm)
TC-253-20 3M (1.70mm)
TC-253-20 4M (1.90mm)
TC-253-20 5M (2.10mm)
Junta Culata de Cilindros
Junta Cabeçote



JD-164-ST



JVS-258-43 - 0249910
Junta Tapa/Tampa Vál. Superior
c/arandelas/arruelas



JAE-381-A - 034898/99
Juego Admisión
Jogo Admissão



JAE-380-E
Múltiple Admisión y Escape
Coletor Admissão e Escape Turbo



1160900 - 1339620
Base termostato
Base termostato



JAE-369-E - 0349780
Juego Escape
Jogo Escapeamento



1160700 - 1339730
Tapa termostato
Tampa termostato



1161000 - 1339550
Base termostato
Base termostato



1164400 - 0236320
Placa lateral
Placa lateral



2737400 - 1339920
Anillo termostato
Anel termostato



1160600 - 1206460
21011307046
Bomba de agua
Bomba de água



1160800 - 0147120
21011008081
Cuerpo termostato
Corpo termostato



2722400
O'ring 47,35 x 1,78mm
Entrada depresor/depresor



2735500 - 1339660
Retén termostato
Retentor termostato



2707200
O'ring 40,87 x 3,53mm
Toma de agua
Toma de água



2737600 - 1339900
O'ring 44 x 2mm
Distribución agua
Distribuição de água



2707000
O'ring 15,64 x 2,62mm
Salida depresor
Saída depresor



RT-612Pol
Jgo. Ret. Guía de Válvulas
Jogo Ret. da Haste de Válv.



RT-8797Pol
Retén Árbol de Levas
Ret. do Eixo Comando de Válv.
Lx-R 35,00 x 50,00 x 8,00



JC-304-26 - 0304340/21011003070
Junta Carter
Junta Carter



1178000 - 0310040/0164300
Junta alojamiento termostato
Junta alojamiento termostato



1163700 - 0147140
Contratapa distribución
Contra-tampa distribuição



2711500 - 0127050
Clavito bancada
Bastão traseiro virabrequim
(Sección/Seção circular)



1174400
Junta placa
inspección
inspeção



RT-8429Vit
Retén Bancada
Ret. Traseiro do Virabrequim
Lx-R 90,00 x 110,00 x 11,00



RT-8510Pol
Retén Distribución
Ret. Dianteiro do Virabrequim
Lx-R 42,00 x 62,00 x 8,00

2612500 - Juego Arandelas Metálicas/Jogo Arruelas Metálicas

Gráfico	Descripción/Descrição	Cant./Quant.
○	Ar./Arruela 22,5x29x2mm Aluminio	1
○	Ar./Arru. blindada 16x22x2,5mm Cobre	3
○	Aran./Arruela 16x21x2mm Cobre	4
○	Aran./Arruela 15x21x1,5mm Cobre	2
○	Aran./Arruela 14x20x2mm Cobre	1
○	Aran./Arruela 14x17x2mm Aluminio	2
○	Aran./Arruela 12x18x3mm Aluminio	1
○	Aran./Arruela 7x14x1mm Hierro	4
○	Ar./Arru. con nervio 6x14mm Acero	4
○	Aran./Arruela 6x11x2mm Aluminio	2

Productos relacionados no incluidos en el juego. Los mismos pueden ser solicitados por separado
Produtos relacionados não incluídos no jogo. Podem ser solicitados em separado / Related products that were not included in the set but can be ordered separately.



BU-025
Bulones para
Culata de Cilindros
Parafusos de Cabeçote



BU-029
Bulones para
Culata de Cilindros
Parafusos de Cabeçote



BU-030
Bulones para
Culata de Cilindros
Parafusos de Cabeçote



JV-156
Jgo. Caja Vel.
Jogo Caixa de
Câmbio



JSA-232-21
JSA-232-22
Salida Escape
Saída Escapeamento



JC-304-15 - 0304340
21011003070
Junta Carter
Junta Carter



1164500 - 1710990
Resonador
Ressonador

DESCRIPCIÓN / Descrição / Description

PEUGEOT: 504 - 505 - J5 - J7- XE - XL
XSE 1973/93 (0199416)
CITROEN: C25 1981/...
FIAT: Ducato 1981/...

MOTOR / Engine	CM ³	HP	Ø PISTON
280/A14-169B	1796	67	84.00
XC7 - XM7/T/P	1796	69/79	85.00

Juego Completo de Reparación:

Jogo de Juntas do Motor / Full Set Gasket:

JR-233-15

R

Semi-Juego de Reparación:

Semi-Jogo de Juntas / Semi-Set Gasket:

Juego de Descarbonización:

Jogo de Juntas Superior / Head Set Gasket:

JD-120-15

R

JUNTA CULATA DE CILINDROS	TC-409-15	Ø 87.00mm	1.60mm	1.60mm	1.60mm
Junta de cabeçote	TC-409-18	Ø 87.00mm	2.50mm	2.50mm	2.50mm
Cylinder Head gasket					



JD-120-15

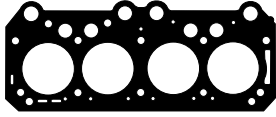

TC-409-15 - 0203450
Junta Culata de Cilindros
Junta Cabeçote



JAE-261-A - 0348181
Junta Admisión
Junta Admissão



JAE-260-09 - 0349030
Juego Escape
Jogo Escapamento



JSA-149 - 1710100
Salida Escape
Saída Escapamento



1070900 - 1206080
Bomba de agua
Bomba de água

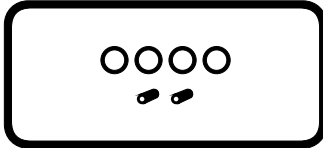

JVS-208-43 - 0249140
Junta Tapa/Tampa Vál. Sup.
c/bujes y arandelas
c/buchas e arruelas

2620800 - Juego Arandelas Metálicas/Jogo Arruelas Metálicas

Gráfico	Descripción/Descrição	Cant./Quant.
○	Aran./Arruela 18x24x2,5mm Cobre	1
○	Aran./Arruela 16x22x2,5mm Cobre	1
○	Aran./Arruela 8x14x1mm Aluminio	4



RT-513Pol
Jgo. Ret. Guía de Válvulas
Jogo Retentor da Haste de Válvulas

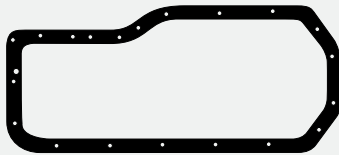

JC-119-30 - 0304030
Junta Cárter
Junta Carter



1069900 - 0321110
Tapa distribución
Tampa distribuição

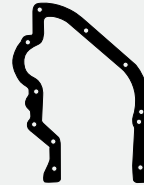

1070000 - 0322040
Contratapa distribución
Contra-tampa distribuição

2709400 - 1031030
O'ring 12,5 x 1,5 mm



1071000 - 1451030
Bomba de nafta
Bomba de gasolina



1070400 - 5907001
Base distribuidor
Base distribuidor



1070100 - 0348060
Codo admisión
Cotovelo admissão



1070700 - 1120010
Caño respiración
Tubo respiro



1070500 - 1104040
Bomba de aceite
Bomba de óleo



2711500 - 0127050
Clavito bancada
Bastão traseiro virabrequim
(Sección/Seção circular)



1070600 - 1115020
Filtro de aceite
Filtro de óleo



1071100 - 6462100
Grifo calefactor
Torneira aquecedor



RT-6687Pol
Retén Retentor
A 156-R 42,00 x 60,00 x 10,00

Productos relacionados no incluidos en el juego. Los mismos pueden ser solicitados por separado
Produtos relacionados não incluídos no jogo. Podem ser solicitados em separado / Related products that were not included in the set but can be ordered separately.

BU-026 Bulones p. Cul. Cil. Parafusos Cabeçote	BU-057 Bulones p. Cul. Cil. Parafusos Cabeçote	JB-149 Jgo. Carburador	JB-174 Jgo. Carburador	1131400 - 0321110 Tapa Distribución Tampa Distribuição	1151000 - P20007 Suplemento Camisa (Jgo. x 4)(0,07mm)	1151100 - P20010 Suplemento Camisa (Jgo. x 4)(0,10mm)	1120800 Junta Palier	JC-119-26 - (1,5mm) JC-119-23 Junta Cárter
---	---	-------------------------------------	-------------------------------------	---	--	--	--------------------------------	--

Juego Completo de Reparación:

Jogo de Juntas do Motor / Full Set Gasket:

JR-200-20**R****Semi-Juego de Reparación:**

Semi-Jogo de Juntas / Semi-Set Gasket:

SJ-229**R****Juego de Descarbonización:**

Jogo de Juntas Superior / Head Set Gasket:

JD-119-20**R**

JUNTA CULATA DE CILINDROS	TC-359-20	∅ 91.00mm	≧ 1.60mm	± 0.05
Junta de cabeçote	TC-359-02	∅ 91.00mm	≧ 1.92mm	± 0.05
Cylinder Head gasket	TC-359-18	∅ 91.00mm	≧ 2.30mm	± 0.05

DESCRIPCIÓN / Descrição / Description

DIESEL**PEUGEOT: 404 - T4B - J7 1959/67****T5B - Indenor 1971/80 (0199541)****RASTROJERO: Rastrojero 1972/...**

MOTOR / Engine	CM ³	HP	∅ PISTON
TMD85/XD85	1816	55	85.00
XD/XDP 4.88	1948	50/59	88.00

ILLINOIS

PEUGEOT

JD-119-20**TC-359-20 - 0203510**
Junta Culata de Cilindros
Junta Cabeçote**JSA-148 - 1710070**
Salida Escape
Saída Escapamento**JSA-140 - 2000695/2009067/WO634814**
Salida Escape
Saída Escapamento**JAE-262-E**
Juego Escape
Jogo Escapamento
(XD2 - XDP)**JAE-327-A**
Múltiple Admisión
Multiple Admissão
(XD2 - XD3 - XDP)**1114400 - 0236070**
Cámara agua
Câmara água**1074800 - 70580577/1206070**
Bomba de agua
Bomba de água**JVS-181-30 - 0249250**
Junta Tapa Válvula Superior
c/ arandelas
Junta Tampa Válvula Superior
c/ arnuelas**RT-517Pol**
Jgo. Ret. Guía Válvulas
Jogo Retentor da Haste
de Válvulas**2621100 - Juego Arandelas Metálicas/Jogo Arnuelas Metálicas**

Gráfico	Descripción/Descrição	Cant./Quant.
	Ar./Arru. blindada 16x22x2,5mm Cobre	3
	Ar./Arruela 16x22x1mm Aluminio	1
	Ar./Arruela c/ nervio 6x14mm Acero	4
	Retén/Retentor válvula 7,5x14x3mm	8
	Ar./Arruela goma/borr. 7x16x4,7mm	1

**JC-214-30 - 0313190/0313070**
Junta Cáster
Junta Carter**1074900 - 0321100**
7058122000
Contratapa distribución
Contra-tampa distribuição**1075000 - 0321090**
7058122700
Tapa distribución
Tampa distribuição**1074700 - 1925040/7058064200**
Bomba inyectora
Bomba injetora**1075200 - 1104130/1104090**
Filtro aceite
Filtro óleo**1075300 - 1179060**
Respiradero aceite
Respirador óleo**1106600 - 1041100**
Asiento bomba
Tampa assento bomba**1066800 - 1170031**
Varilla nivel aceite
Vareta nível óleo**1066500**
Regulación bomba inyectora
Regulagem bomba injetora**1075100 - 0147080/7562048000**
Junta respirador de válvula
Junta respirador de válvulas**2625500 - Juego Arandelas Metálicas/Jogo Arnuelas Metálicas**

Gráfico	Descripción/Descrição	Cant./Quant.
	Arand./Arruela 14x20x2mm Cobre	4
	Ar./Arruela 12,5x15x1mm Aluminio	10
	Arand./Arruela 8x14x1mm Aluminio	6
	Arand./Arruela 8x12x1mm Aluminio	8
	Arand./Arruela 7x10x2mm Aluminio	2
	Var. aceite/Vareta óleo 15x7,5x12mm	1
	Bastón cierre bancada/fech. mancal	2

**RT-6687Pol**
Retén
Retentor
A 156-R 42,00 x 60,00 x 10,00**RT-8032Pol**
Ret. Dianteiro do Virabrequim
Ret. Dianteiro do Virabrequim
Lx-R 45,00 x 60,00 x 10,00

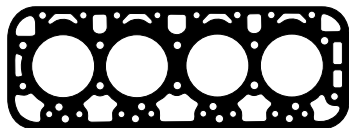
Productos relacionados no incluidos en el juego. Los mismos pueden ser solicitados por separado

Produtos relacionados não incluídos no jogo. Podem ser solicitados em separado / Related products that were not included in the set but can be ordered separately.

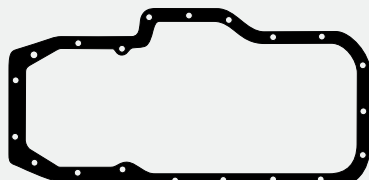
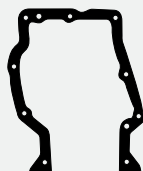
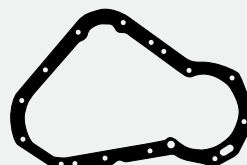
**BU-055**
Bul. p/Culata de Cilindros
Parafusos de Cabeçote**JV-121**
Jgo. Caja de Velocidad
Jogo Caixa de Câmbio**2744300**
Jgo. Ar. Camisa
(Sintético)(Jgo. x 4)**JVS-181-43**
Junta Tapa Vál. Sup. c/ arandelas
Junta Tampa Vál. Sup. c/ arnuelas**JC-214-26**
JC-214-23
Junta Cáster/Carter

DESCRIPCIÓN / Descrição / Description **DIESEL**

PEUGEOT: 206 - 306 - 806 - Expert Partner 1998/... (0197X6)
CITROEN: Berlingo - Jumpy - C15 98/... - Xsara
FIAT: Scudo 1998/...
TOYOTA: Corolla 1999/2001

MOTOR / Engine	CM ³	HP	Ø PISTON
DW8-DWJ-DWY	1867	69/70	82.20
DW8 (WJZ)	1868	71	82.20
1WZ	1868	69	82.20

Juego Completo de Reparación:

Jogo de Juntas do Motor / Full Set Gasket:

Semi-Juego de Reparación:

Semi-Jogo de Juntas / Semi-Set Gasket:

SJ-257



Juego de Descarbonización:

Jogo de Juntas Superior / Head Set Gasket:

JD-257-ST



JUNTA CULATA DE CILINDROS Junta de cabeçote Cylinder Head gasket	TC-609 1M	Ø 84.00mm	1.25mm	de 0,51 a 0,55mm
	TC-609 2M	Ø 84.00mm	1.30mm	de 0,56 a 0,59mm
	TC-609 3M	Ø 84.00mm	1.35mm	de 0,60 a 0,63mm
	TC-609 4M	Ø 84.00mm	1.38mm	de 0,64 a 0,67mm
	TC-609 5M	Ø 84.00mm	1.42mm	de 0,68 a 0,71mm
	TC-609 6M	Ø 84.00mm	1.50mm	de 0,71mm a ...
	TC-609 7M	Ø 84.00mm	1.60mm	
	TC-609 8M	Ø 84.00mm	1.70mm	

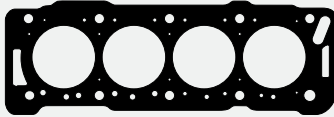

TC-609-20 1M TC-609-MG 1M - 0209X4
TC-609-20 2M TC-609-MG 2M
TC-609-20 3M TC-609-MG 3M
TC-609-20 4M TC-609-MG 4M
TC-609-20 5M TC-609-MG 5M
TC-609-20 6M TC-609-MG 6M
TC-609-20 7M TC-609-MG 7M
TC-609-20 8M TC-609-MG 8M
 Junta Culata de Cilindros
 Junta Cabeçote

JD-257-ST



JAE-448-A - 0348N8/PO
 Juego Admisión
 Jogo Admissão



JAE-449-E - 0349H7
 Juego Escape
 Jogo Escapamento



1160600 - 1206460
 21011307046
 Bomba de agua
 Bomba de água



2706400
 O'ring rectangular
 39 x 47 x 4,3mm



1160800 - 0147120
 21011008081
 Cuerpo termostato
 Corpo termostato



2706500 - 21011005155
 Guarnición termostato
 Guarnição termostato
 47 x 53 x 4,6mm



JVS-287-43 - 024997
 Junta Tapa Válvula Inferior
 Junta Tampa Válvula Inferior

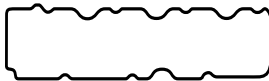

JVS-286-43 - 024995
 Junta Tapa Válvula Superior
 Junta Tampa Válvula Superior

2611300 - Juego Arandelas Metálicas/Jogo Arruelas Metálicas

Gráfico	Descripción/Descrição	Cant./Quant.
	Aran./Arruela 17x21x1,25mm Cobre	3
	Aran./Arruela 16x21x1,5mm Cobre	1
	Aran./Arruela 13x24x3mm Hierro	10
	Aran./Arruela c/nervio 6x14mm Ac.	4



RT-613Pol
 Juego Ret. Guía de Válvulas
 Jogo Retentor da Haste de Válvulas



RT-8797Pol
 Retén Árbol de Levas
 Ret. do Eixo Comando de Válv.
 Lx-R 35,00 x 50,00 x 8,00



JC-304-26 - 0304340
 21011003070
 Junta Cártel
 Junta Carter



1178000 - 0310040
 0164300
 Junta alojamiento termostato
 Junta alojamento termostato



2706700
 Arandela goma con inserción metálica
 Arruela metal/borracha
 19 x 30 x 3mm



2706600 - 133983
 Guarnición dist. de agua
 Guarnição dist. de água
 42 x 49,6 x 3,65mm



2711500 - 0127050
 Clavito bancada (Sección circular)
 Bastão traseiro virabrequim (Seção circular)



RT-9191Vit
 Retén Bancada
 Retentor Traseiro do Virabrequim
 Lx-R 90,00 x 110,00 x 7,00



RT-8510Pol
 Retén Distribución
 Retentor Dianteiro do Virabrequim
 Lx-R 42,00 x 62,00 x 8,00

Productos relacionados no incluidos en el juego. Los mismos pueden ser solicitados por separado.

Produtos relacionados não incluídos no jogo. Podem ser solicitados em separado.

Related products that were not included in the set but can be ordered separately.



BU-029
 Bulones para Culata de Cilindros
 Parafusos de Cabeçote



JC-304-15 - 0304340
 21011003070
 Junta Cártel
 Junta Carter

Juego Completo de Reparación:

Jogo de Juntas do Motor / Full Set Gasket:

Semi-Juego de Reparación:

Semi-Jogo de Juntas / Semi-Set Gasket:

Juego de Descarbonización:

Jogo de Juntas Superior / Head Set Gasket:

JUNTA CULATA DE CILINDROSJunta de cabeçote
Cylinder Head gasket

TC-609 1M	∅ 84.00mm	≡ 1.25mm	± de 0,51 a 0,55mm
TC-609 2M	∅ 84.00mm	≡ 1.30mm	± de 0,56 a 0,59mm
TC-609 3M	∅ 84.00mm	≡ 1.35mm	± de 0,60 a 0,63mm
TC-609 4M	∅ 84.00mm	≡ 1.38mm	± de 0,64 a 0,67mm
TC-609 5M	∅ 84.00mm	≡ 1.42mm	± de 0,68 a 0,71mm
TC-609 6M	∅ 84.00mm	≡ 1.50mm	± de 0,71mm a ...
TC-609 7M	∅ 84.00mm	≡ 1.60mm	
TC-609 8M	∅ 84.00mm	≡ 1.70mm	

DESCRIPCIÓN / Descrição / Description

DIESEL**PEUGEOT:** 206 - 306 - 806 - Expert
Partner 1998/... (0197X6)**CITROEN:** Berlingo - Jumpy - C15 98/... - Xsara
FIAT: Scudo 1998/...**TOYOTA:** Corolla 1999/2001 (JVS Reforma plana)

MOTOR / Engine	CM ³	HP	∅ PISTON
DW8-DWJ-DWY	1867	69/70	82.20
DW8 (WJZ)	1868	71	82.20
1WZ	1868	69	82.20

ILLINOIS

PEUG. / CITROEN

MENÚ

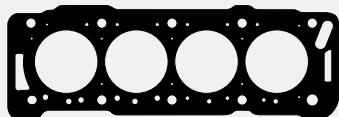

TC-609-20 1M TC-609-MG 1M - 0209X4
 TC-609-20 2M TC-609-MG 2M
 TC-609-20 3M TC-609-MG 3M
 TC-609-20 4M TC-609-MG 4M
 TC-609-20 5M TC-609-MG 5M
 TC-609-20 6M TC-609-MG 6M
 TC-609-20 7M TC-609-MG 7M
 TC-609-20 8M TC-609-MG 8M
 Junta Culata de Cilindros
 Junta Cabeçote

JD-258-ST

JAE-448-A - 0348N8/PO
 Juego Admisión
 Jogo Admissão



JAE-449-E - 0349H7
 Juego Escape
 Jogo Escapamento



1160600 - 1206460
 21011307046
 Bomba de agua
 Bomba de água



2706400
 O'ring rectangular
 39 x 47 x 4,3mm



1160800 - 0147120
 21011008081
 Cuerpo termostato
 Corpo termostato



2706500 - 21011005155
 Guarnición termostato
 Guarnição termostato
 47 x 53 x 4,6mm



JVS-288-43
 Junta Tapa/Tampa Válvula Inferior
 (Adaptación Reforma Plana)
 (Adaptação Reforma Plana)

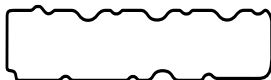

JVS-286-43 - 024995
 Junta Tapa Válvula Superior
 Junta Tampa Válvula Superior

2611300 - Juego Arandelas Metálicas/Jogo Arruelas Metálicas

Gráfico	Descripción/Descrição	Cant./Quant.
○	Arandela 17x21x1,25mm Cobre	3
○	Arandela 16x21x1,5mm Cobre	1
●	Arandela 13x24x3mm Hierro	10
●	Arandela c/nervio 6x14mm Acero	4



RT-613Pol
 Juego Retenes Guía Válvulas
 Jogo Retentor da Haste
 de Válvulas



RT-8797Pol
 Retén Árbol de Levas
 Retentor do Eixo Comando
 de Válvulas
 Lx-R 35,00 x 50,00 x 8,00



JC-304-26 - 0304340
 21011003070
 Junta Cártér
 Junta Carter



1178000 - 0310040
 0164300
 Junta alojamiento termostato
 Junta alojamento termostato



2706700
 Arandela goma con
 inserción metálica
 Arruela borracha con
 inserção metálicas
 19 x 30 x 3mm



2706600 - 133983
 Guarnición
 distribuidora de agua
 Guarnição distribuidora de água
 42 x 49,6 x 3,65mm



2711500 - 0127050
 Clavito bancada
 Bastão traseiro virabrequim
 (Sección circular)



RT-9191Vit
 Retén Bancada
 Retentor Traseiro do Virabrequim
 Lx-R 90,00 x 110,00 x 7,00



RT-8510Pol
 Retén Distribución
 Ret. Dianteiro do Virabrequim
 Lx-R 42,00 x 62,00 x 8,00

Productos relacionados no incluidos en el juego. Los mismos pueden ser solicitados por separado.

Produtos relacionados não incluídos no jogo. Podem ser solicitados em separado.

Related products that were not included in the set but can be ordered separately.



BU-029
 Bulones para
 Culata de Cilindros
 Parafusos de Cabeçote



JC-304-15 - 0304340
 21011003070
 Junta Cártér
 Junta Carter

DESCRIPCIÓN / Descrição / Description

PEUGEOT: 504 - TN - GES - XNA 1976/80
505 - J5 - J9 1970/... (0199413)

MOTOR / Engine CM³ HP Ø PISTON

XN1 - XNA 1971 78/85 88.00

Juego Completo de Reparación:

Jogo de Juntas do Motor / Full Set Gasket:

JR-276-15

R

Semi-Juego de Reparación:

Semi-Jogo de Juntas / Semi-Set Gasket:

SJ-252

R

Juego de Descarbonización:

Jogo de Juntas Superior / Head Set Gasket:

JD-252-15

R

JUNTA CULATA DE CILINDROS	TC-428-15	Ø 91.00mm	1.60mm	±0.05
Junta de cabeçote	TC-428-18	Ø 91.00mm	2.50mm	±0.05
Cylinder Head gasket				

JD-252-15

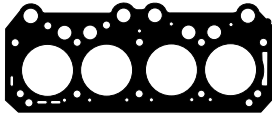

TC-428-15 - 0203460
Junta Culata de Cilindros
Junta Cabeçote



JAE-314-A - 0348330
Junta Admisión
Junta Admissão



JAE-366-E - 0349030
Juego Escape
Jogo Escapamento



JSA-149 - 1710100
Salida Escape
Saída Escapamento



1084600 - 1206220
Bomba de agua
Bomba de água

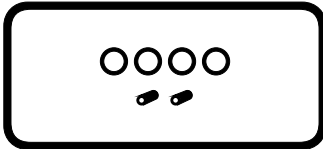

JVS-208-43 - 0249140
Junta Tapa Válvula Sup. c/bujes y arandelas
Junta Tampa Válvula Sup. c/buchas e arandelas

2620800 - Juego Arandelas Metálicas/Jogo Arruelas Metálicas

Gráfico	Descripción/Descrição	Gant./Quant.
	Aran./Arruela 18x24x2,5mm Cobre	1
	Aran./Arruela 16x22x2,5mm Cobre	1
	Aran./Arruela 8x14x1mm Aluminio	4



RT-513Pol
Jgo. Ret. Guía Válvulas
Jogo Retentor da Haste de Válvulas

R

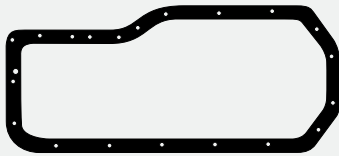

JC-119-30 - 0304030
Junta Carter
Junta Carter



1069900 - 0321110
Tapa distribución
Tampa distribuição

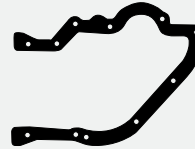

1070000 - 0322040
Contratapa distribución
Contra-tampa distribuição



1070500 - 1104040
Bomba de aceite
Bomba de óleo



1071000 - 1451030
Bomba de nafta
Bomba de gasolina



2711500 - 0127050
Clavito bancada
Bastão traseiro virabrequim
(Sección/Seção circular)



1070400 - 5907001
Base distribuidor
Base distribuidor



1070700 - 1120010
Caño respiración
Tubo respiro



2606600 - 0313030
Arandela 18 x 24 x 2,5mm (Cobre)
Arruela



2711700 - 1710240/134048
Termostato
Termostato



1070600 - 1115020
Filtro aceite
Filtro óleo



RT-6687Pol
Retén
Retentor
A 156-R 42,00 x 60,00 x 10,00

R



1071100 - 6462100
Grifo calefactor
Torneira aquecedor



2709400 - 1031030
O'ring 12,5 x 1,5mm

Productos relacionados no incluidos en el juego. Los mismos pueden ser solicitados por separado
Produtos relacionados não incluídos no jogo. Podem ser solicitados em separado / Related products that were not included in the set but can be ordered separately.



BU-026
BU-032
Bulones para
Culata de Cilindros
Parafusos de Cabeçote



1151000 - (0,07mm)
1151100 - (0,10mm)
Suplemento Camisa
(Jgo. x 4)



JV-157
Jgo Caja Velocidad
Jogo Caixa de Câmbio



1120800
Junta Palier



JB-182
Jgo. Carb.



1131400 - 0321110
Tapa Distribución
Tampa Distribuição



JC-119-26 - (1,5mm)
JC-119-23
Junta Carter



JB-195
Jgo. Carb.

Juego Completo de Reparación:

Jogo de Juntas do Motor / Full Set Gasket:

JR-317-15

DESCRIPCIÓN / Descrição / Description

PEUGEOT: 505 Gamma - 9R - J9/J5 1970/92
504 - 505 con Aire Acondicionado - 604
(0199424)

MOTOR / Engine

MOTOR / Engine	CM ³	HP	Ø PISTON
GR/SR - XN1/XN2	1971	85	88.00
XN2 - XN6	1971	105	88.00

ILLINOIS

PEUGEOT

Semi-Juego de Reparación:

Semi-Jogo de Juntas / Semi-Set Gasket:

SJ-253**Juego de Descarbonización:**

Jogo de Juntas Superior / Head Set Gasket:

JD-143-15

JUNTA CULATA DE CILINDROS	TC-428-15	Ø 91.00mm	1.60mm	±0.05
Junta de cabeçote	TC-428-18	Ø 91.00mm	2.50mm	±0.05
Cylinder Head gasket				

JD-143-15**TC-428-15 - 0203460**
Junta Culata de Cilindros
Junta Cabeçote**JAE-366-E - 0349030**
Juego Escape
Jogo Escapamento**JAE-314-A - 0348330**
Junta Admisión
Junta Admissão**1070700 - 1120010**
Caño respiración
Tubo respiro**JSA-176 - 1710240**
Salida Escape
Saída Escapamento**JSA-149 - 1710100**
Salida Escape
Saída Escapamento**JAE-465-A**
Junta Admisión
Junta Admissão**1058200**
Bomba de agua
Bomba de água**1084600 - 1206220**
Bomba de agua
Bomba de água**RT-553Pol**
Juego Retenes Guía Válvulas
Jogo Ret. da Haste de Válvulas**JVS-208-43 - 0249140**
Junta Tapa Vál. Sup. c/bujes y arandelas
Junta Tampa Vál. Sup. c/buchas e aruelas**2620800 - Juego Arandelas Metálicas/Jogo Arruelas Metálicas**

Gráfico	Descripción/Descrição	Cant./Quant.
	Aran./Arruela 18x24x2,5mm Cobre	1
	Aran./Arruela 16x22x2,5mm Cobre	1
	Aran./Arruela 8x14x1mm Aluminio	4

**RT-6687Pol**
Retén Distribución A 156-R
Ret. Dianteiro do Virabrequim
42,00 x 60,00 x 10,00**JC-119-30 - 0304030**
Junta Carter
Junta Carter**1105000 - 0313040 /0301360**
Cárter aire acondicionado
Carter ar condicionado**1069900 - 0321110**
Tapa distribución
Tampa distribuição**1070000 - 0322040**
Contratapa distribución
Contra-tampa distribuição**1071100 - 6462100**
Grifo calefactor
Torneira aquecedor**2709400 - 1031030**
O'ring 12,5 x 1,5 mm**1070400 - 5907001**
Base distribuidor
Base distribuidor**2710400**
Clavito bancada
(Sección trapezoidal)
Bastão traseiro virabrequim
(Seção Trapezoidal)**1070500 - 1104040**
Bomba de aceite
Bomba de óleo**1070600 - 1115020**
Filtro aceite
Filtro óleo**2711700 - 1710240/134048**
Termostato
Termostato**1071000 - 1451030**
Bomba de nafta
Bomba de gasolina

Productos relacionados no incluidos en el juego. Los mismos pueden ser solicitados por separado

Produtos relacionados não incluídos no jogo. Podem ser solicitados em separado / Related products that were not included in the set but can be ordered separately.

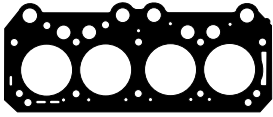
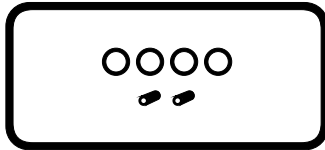
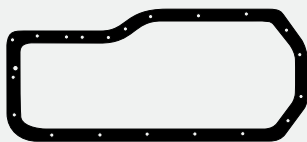
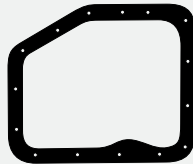
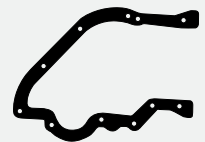
**BU-026**
BU-032
Bulones para
Culata de Cilindros
Parafusos de Cabeçote**1151000 - (0,07mm)**
1151100 - (0,10mm)
Suplemento Camisa
Suplemento Camisa
(Jgo. x 4)**JB-164**
Juego/Jogo
Carburador**JB-193**
Juego/Jogo
Carburador**JB-247**
Juego/Jogo
Carburador**1120800**
Junta Palier
Junta Palier**1131400 - 0321110**
Tapa Distribución
Tampa Distribuição
(Mat. 23)**JC-119-26 - (1,5mm)**
JC-119-23
Junta Carter
Junta Carter

DESCRIPCIÓN / Descrição / Description

PEUGEOT: 206 - 307 - 406 - 407 - 607 2001/...
806 - 807 - Expert 2000/... 16V
CITROEN: Xsara - Evasion 1998/... C4 2004/...
C5 2001/... - Jumpy - Dispatch - C8 2000/...

MOTOR / Engine	CM ³	HP	Ø PISTON
EW10J4 RFN	1997	136	86.20
EW10D RLZ	1997	147	86.20

Juego Completo de Reparación:

Jogo de Juntas do Motor / Full Set Gasket:

JR-512

R

Semi-Juego de Reparación:

Semi-Jogo de Juntas / Semi-Set Gasket:

SJ-512

R

Juego de Descarbonización:

Jogo de Juntas Superior / Head Set Gasket:

JD-512

R

JUNTA CULATA DE CILINDROS	TC-783-15	Ø 85.30mm	1.50mm	±0.05
Junta de cabeçote	TC-783-MG	Ø 85.30mm	1.50mm	±0.05
Cylinder Head gasket	TC-783-18	Ø 85.30mm	2.30mm	±0.05

JD-512

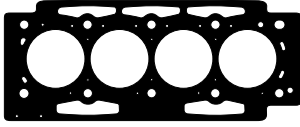

TC-783 - 0209Z3
Junta Culata de Cilindros
Junta Cabeçote



1092500
Bomba de agua grande
Bomba de água grande



1092600
Bomba de agua chica
Bomba de água pequena



2725000
Anillo termostato
Anel termostato



JAE-501-E
Junta Escape
Junta Escapamento



JAE-502-A
Juego Admisión
Jogo Admissão



1092800
Brida chica
Flange pequena



RT-2991Vit - 095645
Juego Retenes Guía de Válvulas
Jogo Retentor da Haste de Válvulas
6,00 x 10,00 x 17,40

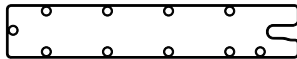

JVS-326-43
Junta Tapa Válvula Superior
Junta Tampa Válvula Superior
(Lado escape/escapamento)

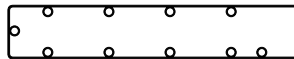

JVS-327-43
Junta Tapa Válvula Superior
Junta Tampa Válvula Superior
(Lado admisión/admissão)



1092700
Brida grande
Flange grande



RT-8796Pol
Retén Árbol de Levas
Retentor do Eixo Comando
de Válvulas
A 156-R 36,00 x 50,00 x 7,00

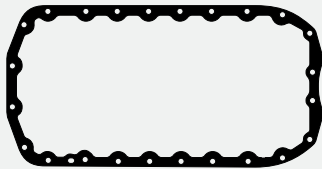

JC-368-26
Junta Cártér
Junta Carter



2726400
Arandela llenado aceite 45 x 49 x 5mm
Arruela enchimento óleo (Sintético)



2725200
O'ring 49 x 2,6mm



2607500
Arandela blindada 16 x 22 x 2,5mm
Arruela blindada (Cobre)



2725600
Arandela 25 x 33 x 2,4mm
Arruela (Goma/Borracha-metal)



2725300
O'ring 28,3 x 1,8mm



1092900
Bomba de aceite
Bomba de óleo



2611000
Arandela blindada 14 x 18 x 2,5mm
Arruela blindada (Cobre)



2725400
Arandela rectangular 40 x 44 x 3mm
Arruela retangular (Sintético)



2725100 - 1145938
Anillo rectangular bomba de aceite
Anel retangular bomba de óleo



RT-9191Vit
Retén Bancada
Retentor Traseiro do Virabrequim
Lx-R 90,00 x 110,00 x 7,00



RT-8573Pol
Retén Distribución
Retentor Dianteiro do Virabrequim
Lx-H 40,00 x 55,00 x 7,00

Productos relacionados no incluidos en el juego. Los mismos pueden ser solicitados por separado.

Produtos relacionados não incluídos no jogo. Podem ser solicitados em separado.

Related products that were not included in the set but can be ordered separately.



BU-119
Bulones para
Culata de Cilindro
Parafusos de Cabeçote

Juego Completo de Reparación:

Jogo de Juntas do Motor / Full Set Gasket:

Semi-Juego de Reparación:

Semi-Jogo de Juntas / Semi-Set Gasket:

Juego de Descarbonización:

Jogo de Juntas Superior / Head Set Gasket:

JUNTA CULATA DE CILINDROS
Junta de cabeçote
Cylinder Head gasket

TC-242 1M	∅ 86.00mm	≧ 1.30mm	± de 0,47 a 0,60mm
TC-242 2M	∅ 86.00mm	≧ 1.35mm	± de 0,61 a 0,65mm
TC-242 3M	∅ 86.00mm	≧ 1.40mm	± de 0,66 a 0,70mm
TC-242 4M	∅ 86.00mm	≧ 1.45mm	± de 0,71 a 0,75mm
TC-242 5M	∅ 86.00mm	≧ 1.50mm	± de 0,76 a 0,83mm
TC-242 6M	∅ 86.00mm	≧ 1.60mm	± de 0,84 a 0,96mm
TC-242 7M	∅ 86.00mm	≧ 1.70mm	± de 0,96mm ...

SJ-397**R****JD-397-ST****R**

DESCRIPCIÓN / Descrição / Description

DIESEL**PEUGEOT:** 206/306 TD - 307 HDI - 406 TD - Boxer HDI 406/607/806 HDI - Expert TD - Partner TD 1999/...**CITROEN:** Xantia - Xsara - Berlingo - C5 - Evasion Synergie - Jumpy HDI - Dispacht - Xsara Picasso Jumper HDI**SUZUKI:** Vitara - Grand Vitara 2000/...

MOTOR / Engine	CM ³	HP	∅ PISTON
DW10 ATED-RHZ	1997	110	85.00
DW10 TD-RHV	1997	110	85.00
DW10 TD-RHY	1997	90	85.00

ILLINOIS

PEUGEOT / CITROEN



TC-242-20 1M TC-242-MG 1M - 0209X5
TC-242-20 2M TC-242-MG 2M - 0209X6
TC-242-20 3M TC-242-MG 3M - 0209X7
TC-242-20 4M TC-242-MG 4M - 0209X8
TC-242-20 5M TC-242-MG 5M - 0209X9
TC-242-20 6M TC-242-MG 6M
TC-242-20 7M TC-242-MG 7M

Junta Culata de Cilindros
Junta Cabeçote

JD-397-ST

JAE-470-A - 0348W4
Junta Admisión
Junta Admissão



JAE-469-E - 0349H4
Junta Escape
Junta Escapamento

2618300 - Juego Arandelas Metálicas/Jogo Arruelas Metálicas

Gráfico	Descripción/Descrição	Cant./Quant.
○	Arandela 18x23x1mm Cobre	1
○	Arandela blindada 14x18x2,5mm Cobre	1
○	Arandela 12x18x1,5mm Cobre	1
●	Arandela 7x16x1,5mm Cobre	4



JVS-306-43 - 024999
Junta Tapa Válvula Superior
Junta Tampa Válvula Superior



RT-9910Vit
Retén Árbol de Levas
Ret. do Eixo Comando de Válvulas
27,00 x 47,00 x 10,00



RT-891Vit
Jgo. Ret. Guía Válvulas
Jogo Retentor da Haste de Válvulas

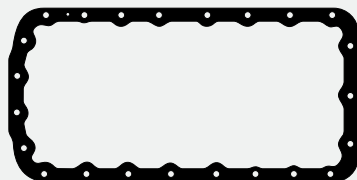

JC-343-26 - 030434
Junta Cártar
Junta Carter



1088500
Junta porta retén distribución
Junta porta retentor distribuição



1160600 - 1206460/21011307046
Bomba de agua
Bomba de água



1104900
Soporte distribución agua trasero y termostato
Suporte distribuição água traseiro e termostato



2706600 - 133983
Guarnición distribución agua
Guarnição distribuição água
42 x 49,6 x 3,65mm



2711500 - 0127050
Clavito bancada
Bastão traseiro virabrequim
(Sección/Seção circular)



RT-9191Vit
Retén Bancada
Retentor Traseiro do Virabrequim
Lx-R 90,00 x 110,00 x 7,00



RT-8510Pol
Retén Distribución
Retentor Dianteiro do Virabrequim
Lx-R 42,00 x 62,00 x 8,00



2711700 - 1710240/134048
Termostato
Termostato

Productos relacionados no incluidos en el juego. Los mismos pueden ser solicitados por separado.

Produtos relacionados não incluídos no jogo. Podem ser solicitados em separado.

Related products that were not included in the set but can be ordered separately.



BU-192
Bulones para Culata de Cilindros
Parafusos de Cabeçote



JT-118
Juego Turbo
Jogo Turbo



JSA-263-21 - 0365260
Salida Escape
Saída Escapamento
(Anillo malla acero/Anel malha aço)



JSA-263-22 - 0365260
Salida Escape
Saída Escapamento
(Fundición/Ferro)

DESCRIPCIÓN / Descrição / Description			
PEUGEOT: 307 - 407 - 807 2005/...			
CITROEN: C4/Pallas - C4 Grand Picasso 2005/... C5 2008/...			
MOTOR / Engine	CM ³	HP	Ø PISTON
EW10A (RFJ) 16V	1997	136/140 143	85.00

Juego Completo de Reparación: Jogo de Juntas do Motor / Full Set Gasket:	JR-592	R		
Semi-Juego de Reparación: Semi-Jogo de Juntas / Semi-Set Gasket:	SJ-592	R		
Juego de Descarbonización: Jogo de Juntas Superior / Head Set Gasket:	JD-592	R		
JUNTA CULATA DE CILINDROS Junta de cabeçote Cylinder Head gasket	TC-783-15 TC-783-MG TC-783-18	Ø 86.20mm Ø 86.20mm Ø 86.20mm	1.50mm 1.50mm 2.30mm	±0.05 ±0.05 ±0.05

JD-592

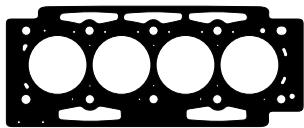

TC-783 - 0209Z3
Junta Culata de Cilindros
Junta Cabeçote



1092500
Bomba de agua grande
Bomba de água grande



1092600
Bomba de agua chica
Bomba de água pequena



2725000
Anillo termostato
Anel termostato



JAE-598-E
Junta Escape
Junta Escapamento



JAE-502-A
Juego Admisión
Jogo Admissão



1092800
Brida chica
Flange pequena



RT-2991Vit - 095645
Juego Retenes Guía de Válvulas
Jogo Retentor haste de Válvulas
6,00 x 10,00 x 17,40



RT-8796Pol
Retén Árbol de Levas
Ret. do Eixo Comando de Válvulas
A 156-R 36,00 x 50,00 x 7,00

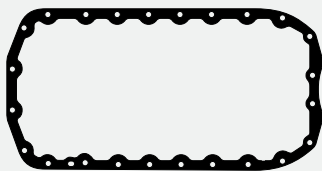

JC-368-26
Junta Cártel
Junta Carter



1092900
Bomba de aceite
Bomba de óleo



1092700
Brida grande
Flange grande



2607500
Arandela blindada 16 x 22 x 2,5mm
Arruela blindada(Cobre)



2726400
Arandela llenado aceite 45 x 49 x 5mm
Arruela enchimento óleo (Sintético)



2725300
O'ring 28,3 x 1,8mm



2725600
Arandela 25 x 33 x 2,4mm
Arruela (Goma/Borracha-metal)



2611000
Arandela blindada 14 x 18 x 2,5mm
Arruela blindada (Cobre)



2725400
Arandela rectangular 40 x 44 x 3mm
Arruela retangular (Sintético)



2725100 - 1145938
Anillo rectangular bomba de aceite
Anel retangular bomba de óleo



2725200
O'ring 49 x 2,6mm



RT-9191Vit
Retén Bancada
Retentor Traseiro do Virabrequim
Lx-R 90,00 x 110,00 x 7,00



RT-8573Pol
Retén Distribución
Ret. Dianteiro do Virabrequim
Lx-H 40,00 x 55,00 x 7,00

Productos relacionados no incluidos en el juego. Los mismos pueden ser solicitados por separado.

Produtos relacionados não incluídos no jogo. Podem ser solicitados em separado.

Related products that were not included in the set but can be ordered separately.



BU-119
Bulones para Culata de Cilindros
Parafusos de Cabeçote



JVS-399-43
Junta Tapa Válvula Superior
Junta Tampa Válvula Superior

Juego Completo de Reparación:

Jogo de Juntas do Motor / Full Set Gasket:

JR-790-11

DESCRIPCIÓN / Descrição / Description

DIESEL**Semi-Juego de Reparación:**

Semi-Jogo de Juntas / Semi-Set Gasket:

SJ-790**PEUGEOT:** Expert III - 3008**CITROEN:** Jumpy III - C4 (0197AW)**Juego de Descarbonización:**

Jogo de Juntas Superior / Head Set Gasket:

JUNTA CULATA DE CILINDROS	TC-894-11	∅ 85.80mm	1.25mm	
Junta de cabeçote				
Cylinder Head gasket				

MOTOR / Engine	CM ³	HP	∅ PISTON
DW10CTED4 (RHC/D/E/H)	1997	150/160	85.00

ILLINOIS

PEUGEOT

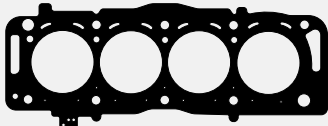

TC-894-11 - 0209GL
Junta Culata de Cilindros
Junta Cabeçote



Junta Admisión
Junta Admissão



R
Retén Arbol de Levas
Retentor do Eixo Comando
de Válvulas

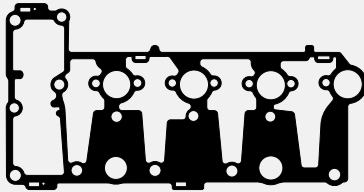

JVS-277-43 - 0348V7
Junta Tapa Válvula Superior
Junta Tampa Válvula Superior



Junta Escape
Junta Escapamento



Juego Retenes Guía de Válvulas
Jogo Retentor da Haste de Válvulas

Productos relacionados no incluidos en el juego. Los mismos pueden ser solicitados por separado.

Produtos relacionados não incluídos no jogo. Podem ser solicitados em separado.

Related products that were not included in the set but can be ordered separately.

DESCRIPCIÓN / Descrição / Description **DIESEL**

PEUGEOT: 406/607/806/807 HDI 2000/... - Expert HDI 1999/...
CITROEN: Evasion 2000/... - C5/C8 2001/... - Jumpy 2002/...HDI
LANCIA: Phedra JTD - Zeta JTD 2000/...
FORD: Focus - C-Max TDCI 2003/...

MOTOR / Engine	CM ³	HP	Ø PISTON
DW10ATED4	1997	109	85.00
DW10JATED4	1997	110	85.00
G6DA/G6DC	1998	135	85.00
DW12TED4 (DOHC)	2179	130/133	85.00

Juego Completo de Reparación:

Jogo de Juntas do Motor / Full Set Gasket:

Semi-Juego de Reparación:

Semi-Jogo de Juntas / Semi-Set Gasket:

SJ-572

R

Juego de Descarbonización:

Jogo de Juntas Superior / Head Set Gasket:

JD-572-ST

R

JUNTA CULATA DE CILINDROS	TC-824 1M	Ø 86.00mm	1.25mm
JUNTA CILINDROS	TC-824 2M	Ø 86.00mm	1.30mm
Junta de cabeçote	TC-824 3M	Ø 86.00mm	1.35mm
Cylinder Head gasket	TC-824 4M	Ø 86.00mm	1.40mm

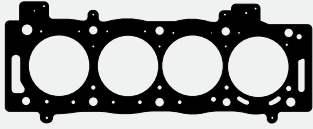

TC-824-20 1M TC-824-MG 1M - 0209AV
TC-824-20 2M TC-824-MG 2M - 0209AW
TC-824-20 3M TC-824-MG 3M - 0209AX
TC-824-20 4M TC-824-MG 4M - 0209AY
 Junta Culata de Cilindros
 Junta Cabeçote

JD-572-ST



JAE-636 - 0349V8
 Múltiple admisión y escape
 Múltiple admissão e escapamento

2607800
 Arandela pico inyector
 Arruela bico injetor
 7,5 x 15 x 1,5mm (Cobre)



JVS-416-43 - 0249A6
 Junta Tapa de Válvula Superior
 Junta Tampa de Válvulas Superior

RT-9910Vit
 Retén Árbol de Levas
 Ret. do Eixo Comando de Válvulas
 Lx-R 27,00 x 47,00 x 7,00

RT-2956Vit
 Juego Retenes Guía de Válvulas
 Jogo Retentor da Haste de Válvulas

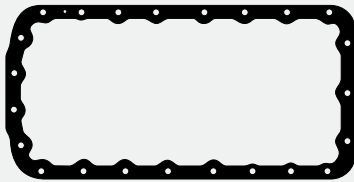

JC-343-26 - 030434
 Junta Cártér
 Junta Carter

2606900
 Arandela tapón cárter
 Arruela Tampão carter
 14 x 20 x 1,5mm (Cobre)

RT-9191Vit
 Retén Bancada
 Retentor Traseiro do Virabrequim
 Lx-R 90,00 x 110,00 x 7,00

RT-8510Pol
 Retén Distribución
 Retentor Dianteiro do Virabrequim
 Lx-H 42,00 x 62,00 x 8,00

Productos relacionados no incluidos en el juego. Los mismos pueden ser solicitados por separado.

Produtos relacionados não incluídos no jogo. Podem ser solicitados em separado.

Related products that were not included in the set but can be ordered separately.

Juego Completo de Reparación:

Jogo de Juntas do Motor / Full Set Gasket:

JR-396-15

DESCRIPCIÓN / Descrição / Description

PEUGEOT: 306 1993/... - 405 1992/... - 806

Boxer 1994/...

CITROEN: ZX 1992/... - Xantia 1993/98 - Evasion

Jumper 1994/...

Semi-Juego de Reparación:

Semi-Jogo de Juntas / Semi-Set Gasket:

SJ-396**Juego de Descarbonización:**

Jogo de Juntas Superior / Head Set Gasket:

JD-396-15

JUNTA CULATA DE CILINDROS	TC-598-15	∅ 87.00mm	1.50mm	↑ ↓
Junta de cabeçote				↑ ↓
Cylinder Head gasket				↑ ↓

MOTOR / Engine	CM ³	HP	∅ PISTON
XU10 J2C	1998	123	86.00
XU10 J2U	1998	109	86.00
Inyección Multipunto			

ILLINOIS

PEUG. / CITROEN

**JD-396-15**

TC-598-15 - 21011003020
Junta Culata de Cilindros
Junta Cabeçote



JAE-426-A - 21051002064
Juego Admisión
Jogo Admissão



JVS-273-43 - 024971
Junta Tapa/Tampa Válvula Superior
c/arandelas/arruelas (Sintético)



JC-304-26 - 0304340/21011003070
Junta Carter
Junta Carter



JSA-263-21 - 0365260
Salida Escape (Fundición)
Saída Escapamento (Ferro)



2706500 - 21011005155/1340480
Guarnición termostato 47 x 53 x 4,6mm
Guarnição termostato



JAE-383-E - 21011002064/0349700
Juego Escape
Jogo Escapamento



JAE-468-E - 1723630
Junta Escape
Junta Escapamento



1160800 - 0147120/21011008081
Cuerpo termostato
Corpo termostato



2711500 - 21081107990
Clavito bancada
Bastão traseiro virabrequim
(Sección/Seção circular)



1160600 - 1206460/21011307046
Bomba de agua
Bomba de água



2711600 - 21011106170
O´ring 4,47 x 1,78mm



2711400 - 0365260
Anillo caja mariposa admisión
Anel caixa borboleta admissão



RT-613Pol
Juego Retenes Guía de Válvulas
Jogo Retentor da Haste de Válvulas



RT-8796Pol
Retén Árbol de Levas
Ret. do Eixo Comando de Válvulas
Lx-Hel 36,00 x 50,00 x 7,00



2706600 - 133983
Guarnición distribuidora
de agua 42 x 49,6 x 3,65mm
Guarnição distribuidora d'água



RT-9191Vit
Retén Bancada
Ret. Traseiro do Virabrequim
Lx-R 90,00 x 110,00 x 7,00



RT-8510Pol
Retén Distribución
Ret. Dianteiro do Virabrequim
Lx-R 42,00 x 62,00 x 8,00

2618500 - Juego Arandelas Metálicas/Jogo Arruelas Metálicas

Gráfico	Descripción/Descrição	Cant./Quant.
	Aran./Arruela 18x23x1mm Cobre	1
	Ar./Arru. blindada 16x22x2,5mm Cobre	1
	Aran./Arruela 15x20x1mm Cobre	1
	Ar./Arru. blindada 14x18x2,5mm Cobre	1
	Aran./Arruela 12x18x3mm Cobre	1
	Aran./Arruela 8x12x1mm Cobre	4

Productos relacionados no incluidos en el juego. Los mismos pueden ser solicitados por separado

Produtos relacionados não incluídos no jogo. Podem ser solicitados em separado / Related products that were not included in the set but can be ordered separately.

**BU-025**Bu. p/Cul. Cilindros
Parafusos Cabeçote**BU-029**Bu. p/Cul. Cilindros
Parafusos Cabeçote**BU-028**Bu. p/Cul. Cilindros
Parafusos Cabeçote**JC-304-15**Junta Carter
Junta Carter**JVS-273-46**Junta Tapa/Tampa Vál. Sup.
c/arandela/arruela (Silic.)**JAE-471-A**Juego Admisión
Jogo Admissão**JAE-383-09**Juego Escape
Jogo Escap.**JSA-263-21**Salida Escape
Saída Escapamento

DESCRIPCIÓN / Descrição / Description

PEUGEOT: 406 - 605 - 806 Turbo 1993/...
CITROEN: Xantia - Synergie Turbo 1995/...
 Evasion - XM

MOTOR / Engine	CM ³	HP	Ø PISTON
XU10 J2TE	1998	150	86.00

Juego Completo de Reparación:

Jogo de Juntas do Motor / Full Set Gasket:

JR-386-15

R

Semi-Juego de Reparación:

Semi-Jogo de Juntas / Semi-Set Gasket:

SJ-386

R

Juego de Descarbonización:

Jogo de Juntas Superior / Head Set Gasket:

JD-386-15

R

JUNTA CULATA DE CILINDROS	TC-598-15	Ø 87.00mm	1.50mm	↑ ↓
Junta de cabeçote				↑ ↓
Cylinder Head gasket				↑ ↓



JD-386-15



TC-598-15 - 21011003020
 Junta Culata de Cilindros
 Junta Cabeçote



RT-613Pol
 Juego Ret. Guía Válvulas
 Jogo Retentor da Haste de Válvulas



RT-8796Pol
 Retén Árbol de Levas
 Ret. do Eixo Comando de Válv.
 Lx-Hel 36,00 x 50,00 x 7,00



JAE-471-A - 406605806/0348N00
 Juego Admisión
 Jogo Admissão



JAE-383-E - 21011002064/0349700
 Juego Escape
 Jogo Escapamento



2711400 - 0365260
 Anillo caja mariposa admisión
 Anel caixa borboleta admissão

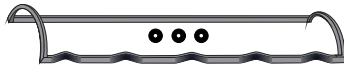

JVS-260-43 - 0249480
 Junta Tapa Válvula Superior c/arruelas
 Junta Tampa Válvula Superior c/arruelas



2706500 - 21011005155/1340480
 Guarnición termostato 47 x 53 x 4,6mm
 Guarnição termostato

2620000 - Juego Aran. Met. Inyectores/Jogo Arruelas Met. Injetores

Gráfico	Descripción/Descrição	Cant./Quant.
	Aran./Arruela 18x22x1,5mm Cobre	1
	Aran./Arruela 17x24x1,5mm Cobre	1
	Ar./Arru. blindada 16x22x2,5mm Cobre	1
	Aran./Arruela 16x20x1,5mm Cobre	1
	Ar./Arru. blindada 14x18x2,5mm Cobre	1
	Aran./Arruela 12x18x3mm Cobre	1
	Aran./Arruela 8x12x1mm Cobre	4
	Aran./Arruela 7x12,5x1,5mm Cobre	3



JC-304-26 - 0304340/21011003070
 Junta Cártér
 Junta Carter

2711600 - 21011106170
 O'ring 4,47 x 1,78mm



2711500 - 21081107990
 Clavito bancada
 Bastão traseiro virabrequim
 (Sección/Seção circular)



1160800 - 0147120
 21011008081
 Cuerpo termostato
 Corpo termostato



JAE-468-E - 1723630
 Junta Escape
 Junta Escapamento



JSA-263-21 - 0365260
 Salida Escape (Fundición)
 Saída Escapamento



2706600 - 133983
 Guarnición distribuidora de agua 42 x 49,6 x 3,65mm
 Guarnição distribuidora de água



1160600 - 1206460
 21011307046
 Bomba de agua
 Bomba de água



RT-9191Vit
 Retén Bancada
 Ret. Traseiro do Virabrequim
 Lx-R 90,00 x 110,00 x 7,00



RT-8510Pol
 Retén Distribución
 Ret. Diant. do Virabrequim
 Lx-R 42,00 x 62,00 x 8,00

Productos relacionados no incluidos en el juego. Los mismos pueden ser solicitados por separado.

Produtos relacionados não incluídos no jogo. Podem ser solicitados em separado.

Related products that were not included in the set but can be ordered separately.



BU-025
 Bulones para Culata de Cilindros
 Parafusos Cabeçote



BU-029
 Bulones para Culata de Cilindros
 Parafusos Cabeçote



BU-028
 Bulones para Culata de Cilindros
 Parafusos Cabeçote



JC-304-15
 Junta Cártér
 Junta Carter



JAE-383-09
 Juego Escape
 Jogo Escap.



JSA-263-21
 Salida Escape
 Saída Escapamento

Juego Completo de Reparación:

Jogo de Juntas do Motor / Full Set Gasket:

JR-505-15**Semi-Juego de Reparación:**

Semi-Jogo de Juntas / Semi-Set Gasket:

SJ-594**Juego de Descarbonización:**

Jogo de Juntas Superior / Head Set Gasket:

JD-505-15

JUNTA CULATA DE CILINDROS	TC-780-15	∅ 87.00mm	1.50mm		
Junta de cabeçote					
Cylinder Head gasket					

DESCRIPCIÓN / Descrição / Description

PEUGEOT: 306 1997/... - 405 1995/... - 406 1995/...

605 1995/... - 806 1998/...

CITROEN: Xsara 2000/... - Xantia 1995/2001

Evasion 1998/... - Synergie 1998/... (019767/X8)

MOTOR / Engine	CM ³	HP	∅ PISTON
XU10 J4R 16V	1998	132/135	86.00
XU10 J4R (RFV) 16V	1998	132/135	86.00

ILLINOIS

PEUG. / CITROEN

JD-505-15**TC-780-15** - 0209J8
Junta Culata de Cilindros
Junta Cabeçote**1118600** - 1340330
Alojamiento termostato
Alojamento termostato**2710300**
Tubo llenado aceite
Tubo enchimento óleo**2706500** - 1340480
21011005155
Guarnición termostato
Guarnição termostato
47 x 53 x 4,6mm**2723100**
O'ring admisión
O'ring admissão**JAE-437-A** - 0348C8
Junta Admisión
Junta Admissão**JAE-409-09** - 0349400/0349F4
Junta Escape
Junta Escapamento**JAE-462-A** - 0348K6
Toberas admisión
Coletor admissão**2614400**
Arandela 6,8 x 13,5 x 1mm
Arruela (Aluminio y goma/borracha)**JVS-312-43** - 0249A2
Junta Tapa Válvula Superior
Junta Tampa Válvula Superior (c/Curva)**JVS-313-43** - 0249A3
Junta Tapa Válvula Superior
Junta Tampa Válvula Superior (Recta)**RT-2992Pol** - 095642
Juego Retenes Guía de Válvulas
Jogo Retedor da Haste de Válvulas
6,00 x 8,50 x 17,60**RT-8796Pol**
Retén Árbol de Levas
Ret. do Eixo Comando de Válvulas
Lx-Hel 36,00 x 50,00 x 7,00**JC-304-26** - 0304340/21011003070
Junta Cártel
Junta Carter**2745300** - 0112780
Juego arandelas camisa
Jogo arruelas camisa (Silicona/Silicone)**2711500** - 0127050
Clavito bancada
Bastão traseiro virabrequim (Sección/Seção circular)**1160600** - 1206460
21011307046
Bomba de agua
Bomba de água**2701900** - 3910824
O'ring 9,25 x 1,78mm**2620900 - Juego Arandelas Metálicas/Jogo Arruelas Metálicas**

Gráfico	Descripción/Descrição	Cant./Quant.
	Aran./Arruela 16x22x1mm Cobre	1
	Ar./Arru. blindada 14x18x2,5mm Cobre	1
	Aran./Arruela 6x10,5x2mm Cobre	1
	Aran./Arruela 6x10x1mm Aluminio	3

**RT-919Vit**
Retén Bancada
Retentor Traseiro do Virabrequim
Lx-R 90,00 x 110,00 x 7,00**RT-8510Pol**
Retén Distribución
Retentor Dianteiro do Virabrequim
Lx-R 42,00 x 62,00 x 8,00

Productos relacionados no incluidos en el juego. Los mismos pueden ser solicitados por separado.

Produtos relacionados não incluídos no jogo. Podem ser solicitados em separado.

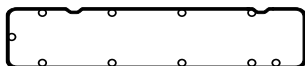
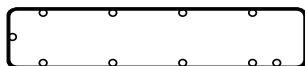
Related products that were not included in the set but can be ordered separately.

**BU-046**
Bulones para Culata de Cilindros
Parafusos Cabeçote**JC-304-15** - 0304340
21011003070
Junta Cártel
Junta Carter

DESCRIPCIÓN / Descrição / Description DIESEL			
PEUGEOT: Boxer III 2006/...			
CITROEN: Jumper III			
MOTOR / Engine	CM ³	HP	Ø PISTON
4HU/4HV (P22DTE) Puma	2198	100/120	86.00

Juego Completo de Reparación: Jogo de Juntas do Motor / Full Set Gasket:	JR-791-11	R		
Semi-Juego de Reparación: Semi-Jogo de Juntas / Semi-Set Gasket:	SJ-791	R		
Juego de Descarbonización: Jogo de Juntas Superior / Head Set Gasket:	JD-791-ST	R		
JUNTA CULATA DE CILINDROS Junta de cabeçote Cylinder Head gasket	TC-891-11	Ø 87.10mm	1.10mm	

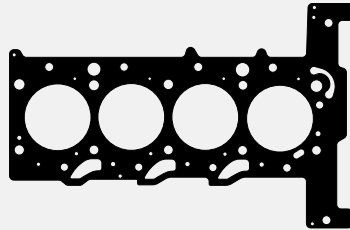

TC-891-11 - 0209EH/6C1Q6051AB
Junta Culata de Cilindros
Junta Cabeçote

JD-791-ST

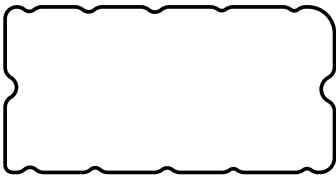

JVS-263-43 - 0249E9/9662221680/1099778/1143176
Junta Tapa Válvula Superior
Junta Tampa Válvula Superior



JAE-609-A - 1138392/9661743180/0348T1
Juego Admisión
Jogo Admissão



JAE-610-E - 1120402/1137860
Junta Escape
Junta Escapamento



2703500 - 1738590
Anillo Admisión
Anel Admissão



2704800 - 1098228
Termostato



Jgo. Ret. Guía de Válvulas
Jgo. Ret. haste de Válvulas

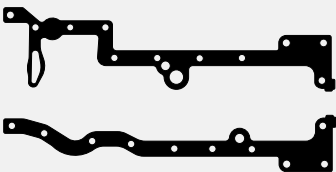

JC-402-15 - 1228836/112953
Junta Cárter
Junta Carter



1156800 - 1094599
Bomba inyectora
Bomba injetora



1196600 - 1146959
Bomba vacío
Bomba vácuo



Retén Distribución
Retentor Distribuição



1198000 - 1322526/1107599/4C1Q8K525AB/YC1Q8K525AC
Tubo refrigerante
Tubo refrigeração



1177500 - 1096559
Bomba de agua
Bomba d'água



2701100 - 1721342
Filtro de aceite
Filtro de óleo



Porta retén bancada
Porta retentor mancal

Productos relacionados no incluidos en el juego. Los mismos pueden ser solicitados por separado.

Produtos relacionados não incluídos no jogo. Podem ser solicitados em separado.

Related products that were not included in the set but can be ordered separately.

Juego Completo de Reparación:

Jogo de Juntas do Motor / Full Set Gasket:

Semi-Juego de Reparación:

Semi-Jogo de Juntas / Semi-Set Gasket:

Juego de Descarbonización:

Jogo de Juntas Superior / Head Set Gasket:

JUNTA CULATA DE CILINDROS	TC-538-20 1M	Ø 96.00mm	1.45mm	de 0.69 a 0.79mm
Junta de cabeçote	TC-538-20 2M	Ø 96.00mm	1.60mm	de 0.80 a 0.89mm
Cylinder Head gasket	TC-538-20 3M	Ø 96.00mm	1.70mm	de 0.90 a 0.99mm
	TC-538-20 4M	Ø 96.00mm	1.80mm	de 1.00 a 1.05mm
	TC-538-20 5M	Ø 96.00mm	1.90mm	de 1.06 a 1.09mm
	TC-538-20 6M	Ø 96.00mm	2.10mm	de 1,10mm ...

SJ-215

R

JD-153-ST

R

DESCRIPCIÓN / Descrição / Description

DIESEL

PEUGEOT: XD2 504/505D - 505/604TD
J7D/J9D - XD3 504/505D - 505/604TD - J9
SSANG YONG: Korando Family 1993/96

MOTOR / Engine	CM ³	HP	Ø PISTON
XD2/S/P	2304	70/73	94.00
XD3/P	2498	76/90	94.00

ILLINOIS

PEUGEOT

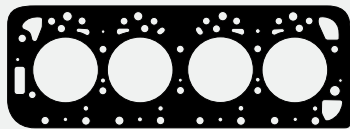

TC-538-20 1M
TC-538-20 2M
TC-538-20 3M
TC-538-20 4M
TC-538-20 5M
TC-538-20 6M

Junta Culata de Cilindros/Junta Cabeçote



JAE-262-E

Juego Escape (XD2 - XDP)
Jogo Escapamento



JAE-351-E

Juego Escape (XD3)
Jogo Escapamento



JAE-327-A

Juego Admisión (XD2 - XD3 - XDP)
Jogo Admissão



JVS-181-30 - 0249250

Junta Tapa Válvula Superior c/arruelas
Junta Tapa Válvula Superior c/arruelas

JD-153-ST



1074800 - 70580577
1206070
Bomba de agua
Bomba de água



1114400 - 0236070
Cámara agua
Câmara de água



2737400 - 1339920
Anillo termostato
Anel termostato



JSA-208 - 1720270
Salida Escape
Saída Escapamento



1113100 - 1206230
Bomba de agua
Bomba de água



JSA-187 - 1710200
Salida Escape (Arandela)
Saída Escapamento (Arruela)



JSA-189 - 1710430
Salida Escape
Saída Escapamento



1106800 - 0147100
Tapa lateral block
Tampa lateral bloco



RT-613Pol
Juego Ret. Guía Válvulas
Jgo. Ret. da Haste de Válv.

2628500 - Juego Arandelas Metálicas/Jogo Arruelas Metálicas

Gráfico	Descripción/Descrição	Cant./Quant.
	Clavito ban. tras./Bastão tras. virab.	2
	7702057732 Arandela tapa válvula	4
	Ar./Arruela 18x24x2mm Cobre	1
	Ar./Arru. blindada 16x22x2,5mm Cobre	3
	Ar./Arruela 16x21x2mm Cobre	4
	Ar./Arruela 14x20x1,5mm Cobre	1
	Ar./Arruela 12x16x1,5mm Cobre	8
	Ar./Arruela de goma 7x16x4,7mm	1
	Ret. Ar./Arruela válvula 7,5x14x3mm	8
	Ar./Arruela c/nervio 6x14mm Acero	4
	Ar./Arruela 8x13x1.25mm Cobre	6
	Ar./Arruela 8x12x1mm Cobre	8

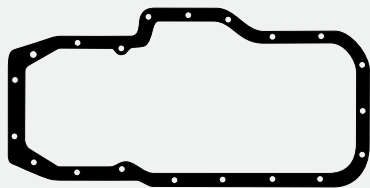

JC-214-30 - 0313190/0313070
Junta Carter
Junta Carter

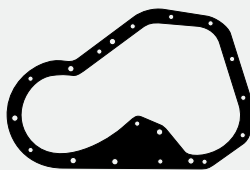

1106400 - 0321390
Tapa distribución
Tampa distribuição



1106300 - 0322081
Contratapa distribución
Contra-tampa distribuição

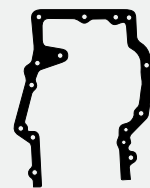

1007100 - 0322220
Contratapa distribución
Contra-tampa distribuição



1106600 - 1041100
Asiento/Assento bomba



1199700
Tapa/Tampa



1066500
Regulación bomba inyectora
Regulagem bomba injetora



1075200 - 1104130
Filtro aceite
Filtro óleo



1172900 - 1927070
Bomba inyectora
Bomba injetora



1074700 - 1925040
7058064200
Bomba inyectora
Bomba injetora



2728000
O'ring 101,32 x 1,78mm
Soporte y chapa distribución
Suporte e chapa distribuição



RT-6687Pol
Retén A 156-R
Retentor
42,00 x 60,00 x 10,00



RT-8032Pol
Retén Distribución Lx-R
Retentor Dianteiro do Virabrequim
45,00 x 60,00 x 10,00



RT-8376Pol
Retén Distribución Lx-Hel
Ret. Dianteiro do Virabrequim
45,00 x 60,00 x 7,00

Productos relacionados no incluidos en el juego. Los mismos pueden ser solicitados por separado.

Produtos relacionados não incluídos no jogo. Podem ser solicitados em separado.

Related products that were not included in the set but can be ordered separately.



BU-023
Bulones para Culata de Cilindros
Parafusos Cabeçote



BU-024
Bulones para Culata de Cilindros
Parafusos Cabeçote



JT-105
Juego Turbo
Jogo Turbo



JVS-181-43
Junta Tapa/Tampa Vál. Sup. (Sintético)
c/arruelas/arruelas



JC-214-26 - (1,5mm)
JC-214-23
Junta Carter
Junta Carter

DESCRIPCIÓN / Descrição / Description

RASTROJERO: Pick Up - NP6 1955/66

MOTOR / Engine CM³ HP Ø PISTON

Borgward D4M 1758 42 78.00

Juego Completo de Reparación:

Jogo de Juntas do Motor / Full Set Gasket:

JR-206-15

R

Semi-Juego de Reparación:

Semi-Jogo de Juntas / Semi-Set Gasket:

Juego de Descarbonización:

Jogo de Juntas Superior / Head Set Gasket:

JD-127-15

JUNTA CULATA DE CILINDROS

Junta de cabeçote

Cylinder Head gasket

TC-372-15

∅ 78.50mm

1.60mm

TC-372-02

∅ 78.50mm

1.90mm

∅

∅

∅

∅



JD-127-15

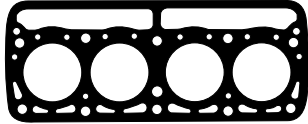

TC-372-15 - C46121
Junta Culata de Cilindros
Junta Cabeçote



JSA-103 - E411235
Salida Escape
Saída Escapamento



JAE-111-E - E15165
Juego Escape
Jogo Escapamento



1074600 - 0713026000/E121236
Carcasa termostato
Carcaça termostato



2732300 - 0009825400
36DIN71511
Tubo admisión
Tubo admissão



1073700 - 130927110
E15167
Termostato
Tertmostato



JVL-150-30
Junta Tapa Válvula Lateral
Junta Tampa Válvula Lateral



JVS-183-30 - E411224
Junta Tapa Válvula Superior
Junta Tampa Válvula Superior



1071400 - 1401123
Bomba de agua
Bomba d'água



1072600 - E41177
Válvula reguladora
Válvula reguladora



JC-217-30 - 0713015600
Junta Cáster
Junta Carter



1071300 - RD101
Bomba de agua
Bomba de água



1115600 - E111118
Salida cigüeñal
Saída virabrequim



1071600 - E12126
Bomba de aceite
Bomba de óleo



1072400
0713013600 - E411112
Filtro de aceite
Filtro de óleo



1071800 - E121519
Bomba de aceite y block
Bomba de óleo e bloco



1071700 - E121515
Entre bomba de aceite
Entre bomba de óleo



1072700 - E46179
Bomba inyectora
Bomba injetora



1071500 - B41115
Bomba de agua
Bomba de água



1072300
0453065200 - E411111
Filtro aceite
Filtro óleo



1074400 - 0713064700
Bomba de combustible
Bomba de combustível

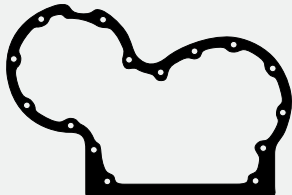

1072100 - C41115
Tapa distribución
Tampa distribuição



1071900 - B41114
Caja a block distribución
Caixa ao bloco distribuição



1072500 - D41173
Fijación bomba inyector
Fixação bomba injetor



RT-5834
Retén Distribución
Retenedor Dianteiro do Virabrequim
A 023 45,00 x 68,00 x 10/17,00

R

Productos relacionados no incluidos en el juego. Los mismos pueden ser solicitados por separado.

Produtos relacionados não incluídos no jogo. Podem ser solicitados em separado.

Related products that were not included in the set but can be ordered separately.



1086200
Junta Diferencial
(Grande)



1086100
Junta Diferencial
(Chico/Pequeno)



1074500
0713026100
Tapa/Tampa Termostato



1142200
370082
Soga Bancada
Gaxeta Mancal

Juego Completo de Reparación:

Jogo de Juntas do Motor / Full Set Gasket:

JR-207-15

DESCRIPCIÓN / Descrição / Description

DIESEL**RASTROJERO:** Pick Up - Kombi - Frontal
NP66 - P63/P64 - C66 - P67 1964/71 - NC62

MOTOR / Engine

CM³

HP

Ø PISTON

Borgward
D301 - E1D

1797

52

78.00

Semi-Juego de Reparación:

Semi-Jogo de Juntas / Semi-Set Gasket:

JD-128-15**Juego de Descarbonización:**

Jogo de Juntas Superior / Head Set Gasket:

JUNTA CULATA DE CILINDROS	TC-373-15	Ø 80.00mm	1.60mm	↑ ↓
Junta de cabeçote	TC-373-02	Ø 80.00mm	1.90mm	↑ ↓
Cylinder Head gasket				↑ ↓

ILLINOIS

RASTROJERO

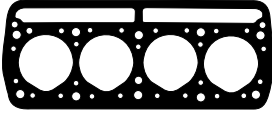
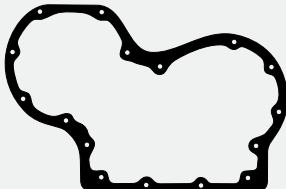
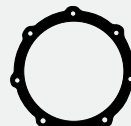
**JD-128-15****TC-373-15** - 130906146
Junta Culata de Cilindros
Junta Cabeçote**1074600** - 0713026000/E121236
Carcasa termostato
Carça termostato**JAE-272-A**
Juego Admisión
Jogo Admissão**JAE-111-E** - E15165
Juego Escape
Jogo Escapamento**1073500** - 130920109
Bomba de agua
Bomba d'água**JVS-184-30**
Junta Tapa Válvula Superior
Junta Tampa Válvula Superior**JSA-140** - 2000695/2009067/W0634814
Salida Escape
Saída Escapamento**1073700** - 130927110/E15167
Termostato
Termostato**JC-217-30** - 0713015600
Junta Cártel
Junta Carter**1072300**
0453065200 - E411111
Tapa filtro aceite
Tampa filtro óleo**1072400**
0713013600 - E411112
Filtro aceite a block/Filtro óleo ao bloco**1073800** - 130931112
Bomba de aceite
Bomba de óleo**1073600** - 130924104
Soporte carcasa
Soporte carça**1074100** - 130942101
Bomba inyectora
Bomba injetora**1073400** - 130920108
Bomba de agua
Bomba d'água**1073000** - 130901122
Respirador cárter
Respirador carter**1073900** - 130932105
Bomba de aceite
Bomba de óleo**1074400** - 0713064700
Bomba de combustible
Bomba de combustível**1074000** - 130940109
Tubo venturi
Tubo venturi**1073200** - 130903104/B41114
Tapa distribución
Tampa distribuição**1075400** - 130903110
Caja a block distribución
Caixa ao bloco distribuição**1073300** - 130903111
Brida a bomba inyectora
Flange ao bomba injetora**RT-5834**
Retén Distribución
Ret. Dianteiro do Virabrequim
A 023 45,00 x 68,00 x 10/17,00

Productos relacionados no incluidos en el juego. Los mismos pueden ser solicitados por separado

Produtos relacionados não incluídos no jogo. Podem ser solicitados em separado / Related products that were not included in the set but can be ordered separately.

**1086200**
Junta Diferencial
(Grande)**1086100**
Junta Diferencial
(Chico/Pequeno)**1074500**
0713026100
Tapa/Tampa Termostato**1142200**
Soga Bancada
Gaxeta Mancal**JSA-167-22**
Salida Escape
Saída Escapamento**JSA-167-21**
Salida Escape
Saída Escapamento

DESCRIPCIÓN / Descrição / Description

RENAULT: Gordini 1962/64 - Dauphine 4L
4F 1960/64 - Floride - R3 - R5 - R6 - Rodeo
(9803903)

MOTOR / Engine	CM ³	HP	Ø PISTON
680	603/747		54.50
839	782		55.80
670 - 04/05/800	845		58.00

Juego Completo de Reparación:

Jogo de Juntas do Motor / Full Set Gasket:

JR-210-15



Semi-Juego de Reparación:

Semi-Jogo de Juntas / Semi-Set Gasket:

Juego de Descarbonización:

Jogo de Juntas Superior / Head Set Gasket:

JD-107-15

JUNTA CULATA DE CILINDROS	TC-377-15	Ø 59.30mm	1.60mm	↕
Junta de cabeçote		Ø	↔	↕
Cylinder Head gasket		Ø	↔	↕



JD-107-15

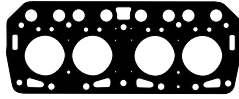

TC-377-15 - 5544952
Junta Culata de Cilindros
Junta Cabeçote



JVS-186-30 - 5540379
Junta Tapa Válvula Superior
Junta Tampa Válvula Superior



1076500 - 6058371/6038375
Salida agua
Saída água



JAE-275 - 6066788
Múltiple Admisión y Escape
Coletor Admissão e Escapamento



JAE-274 - 6069482
Múltiple Admisión y Escape
Coletor Admissão e Escapamento



1076100 - 6042349
Cámara de agua
Câmara água



JC-220-30 - 4261399
Junta Cáster
Junta Carter



1075700 - 5545559/6030957
Cuerpo bomba de agua
Corpo bomba de água



1076400 - 6057526/6069546
Bomba de agua a block
Bomba de água ao bloco



1075500 - 4261155
Tapa distribución
Tampa distribuição

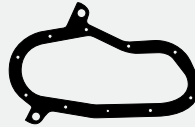

1075600 - 4261156
Placa distribución
Placa distribuição



1076700 - 7056598
Bomba de nafta
Bomba de gasolina



1075900 - 6027824
Bomba de aceite
Bomba de óleo



1076300 - 6052269
Calefacción
Aquecimento



1075800 - 6023496
Base bomba de nafta
Base bomba de gasolina



1076000 - 6028670
Aislante bomba nafta
Isolante bomba gasolina



1076200 - 6051531
Entre múltiple
Entre múltiplo



RT-6696Pol
Retén Distribución
Ret. Dianteiro do Virabrequim
Lz-R 32,00 x 50,00 x 8,00

Productos relacionados no incluidos en el juego. Los mismos pueden ser solicitados por separado.

Produtos relacionados não incluídos no jogo. Podem ser solicitados em separado.

Related products that were not included in the set but can be ordered separately.



JV-126
Jgo Caja Vel.
Jogo Caixa de Câmbio



JB-152
Juego Carburador
Jogo Carburador



JB-153
Juego Carburador
Jogo Carburador

Juego Completo de Reparación:

Jogo de Juntas do Motor / Full Set Gasket:

JR-376-15**Semi-Juego de Reparación:**

Semi-Jogo de Juntas / Semi-Set Gasket:

Juego de Descarbonización:

Jogo de Juntas Superior / Head Set Gasket:

JD-107-15

JUNTA CULATA DE CILINDROS	TC-377-15	Ø 59.30mm	1.60mm	↑ ↓
Junta de cabeçote				↑ ↓
Cylinder Head gasket				↑ ↓

DESCRIPCIÓN / Descrição / Description

RENAULT: R5 1973/84

MOTOR / Engine	CM ³	HP	Ø PISTON
839.01 - 800.10	845	39	58.00

ILLINOIS

RENAULT

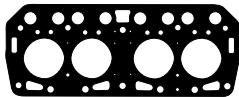
**JD-107-15**

TC-377-15 - 5544952
Junta Culata de Cilindros
Junta Cabeçote



JVS-186-30 - 5540379
Junta Tapa Válvula Superior
Junta Tampa Válvula Superior



1076500 - 6058371/6038375
Salida de agua
Saída de água



JAE-274 - 6069482
Múltiple Admisión y Escape
Coletor Admissão e Escapamento



JAE-275 - 6066788
Múltiple Admisión y Escape
Múltiple Admissão e Escapamento



1076700 - 7056598
Bomba de nafta
Bomba de gasolina



JC-220-30 - 4261399
Junta Cáster
Junta Carter



1076100 - 6042349
Cámara de agua
Câmara de água



1146300 - 7700534110
Placa bomba de agua
Placa bomba de água



1146400 - 0428605700
Distribución
Distribuição



1146500 - 0832094700
Distribución
Distribuição



1146600 - 7700534109
Bomba de agua
Bomba de água



1075900 - 6027824
Bomba de aceite
Bomba de óleo



1075800 - 6023496
Base bomba de nafta
Base bomba de gasolina



1076200 - 6051531
Entre múltiple
Entre múltiplo



1076000 - 6028670
Aislante bomba de nafta
Isolante bomba gasolina



1076300 - 6052269
Calefacción
Aquecedor

Productos relacionados no incluidos en el juego. Los mismos pueden ser solicitados por separado.

Produtos relacionados não incluídos no jogo. Podem ser solicitados em separado.

Related products that were not included in the set but can be ordered separately.

DESCRIPCIÓN / Descrição / Description

RENAULT: Twingo 1996/... - Clio 1995/...
Kangoo 1997/... - Clio II 2000/...

MOTOR / Engine	CM ³	HP	Ø PISTON
D7D	999	59	69.00
D7F - D7D 734	1149	55/60	69.00

Juego Completo de Reparación:

Jogo de Juntas do Motor / Full Set Gasket:

JR-395-15

R

Semi-Juego de Reparación:

Semi-Jogo de Juntas / Semi-Set Gasket:

SJ-395

R

Juego de Descarbonización:

Jogo de Juntas Superior / Head Set Gasket:

JD-395-15

R

JUNTA CULATA DE CILINDROS	TC-332-15	Ø 70.00mm	1.50mm	Reparación
Junta de cabeçote				Reparação
Cylinder Head gasket				Reparazione



JD-395-15

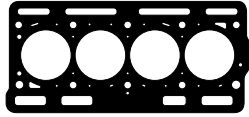

TC-332-15 - 8200034315
Junta Culata de Cilindros
Junta Cabeçote



JAE-463-E - 7700866689
7700107886
Junta Escape
Junta Escapamento



JAE-464-A - 7700204945
Juego Admisión
Jogo Admissão

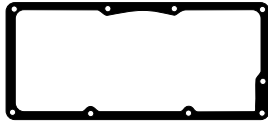

JVS-289-15 - 7701471213
Junta Tapa Válvula Superior
Junta Tampa Válvula Superior

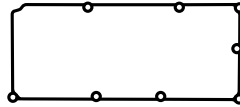

JVS-289-43
Junta Tapa Válvula Superior
Junta Tampa Válvula Superior



RT-2976Pol
Juego Retenes Guía de Válvulas
Jogo Retentor da Haste de Válvulas



JC-322-15 - 7700866465
Junta Cártel
Junta Carter



2726400
Arandela goma 45 x 49 x 5mm
Arruela borracha 45 x 49 x 5mm



RT-6690Pol
Retén Arbol de Levas
Retentor do Eixo Comando de Válvulas
Lz-R 30,00 x 42,00 x 7,00



RT-9802Vit
Retén Distribución
Ret. Dianteiro do Virabrequim
Lx-R 32,00 x 44,00 x 6,00



RT-9771Vit
Retén Bancada
Ret. Traseiro do Virabrequim
Mx-R AH 70,00 x 86,00 x 7,00

Productos relacionados no incluidos en el juego. Los mismos pueden ser solicitados por separado.

Produtos relacionados não incluídos no jogo. Podem ser solicitados em separado.

Related products that were not included in the set but can be ordered separately.



BU-059
Bulones para Culata de Cilindros
Parafusos de Cabeçote

Juego Completo de Reparación:

Jogo de Juntas do Motor / Full Set Gasket:

JR-528**R****Semi-Juego de Reparación:**

Semi-Jogo de Juntas / Semi-Set Gasket:

SJ-528**R****Juego de Descarbonización:**

Jogo de Juntas Superior / Head Set Gasket:

JD-528**R**

JUNTA CULATA DE CILINDROS	TC-886-15	∅ 70.00mm	≡ 1.00mm	↕
Junta de cabeçote	TC-886-MG	∅ 70.00mm	≡ 1.00mm	↕
Cylinder Head gasket	TC-886-18	∅ 70.00mm	≡ 2.30mm	↕

DESCRIPCIÓN / Descrição / Description

RENAULT: Twingo - Clio - Clio II 2001/...

Kangoo 16V 2000/... - Sandero 2009/...

Modus 2001/... (7701473003)

PEUGEOT: 206 16V 2000/...

MOTOR / Engine	CM ³	HP	∅ PISTON
D4D	999	68/70	69.00
D4D 702/712/720	1149	75	69.00
D4F 700/712/720	1149	75	69.00

ILLINOIS

RENAULT

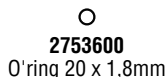
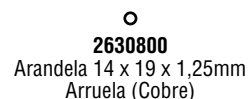
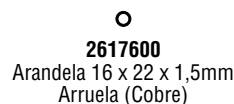
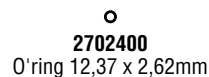
JD-528**TC-886 - 8200086698**
Junta Culata de Cilindros
Junta Cabeçote**JAE-513-E - 8200310867**
Junta Escape
Junta Escapamento**JVS-314-43 - 7701049888**
Junta Tapa de Válvula Superior
Junta Tampa Válvula Superior**2753600**
O'ring 20 x 1,8mm**JAE-514-A - 7701473007**
Juego Admisión
Jogo Admissão**2730500 - 7701049890**
Tapa caja admisión
Tampa caixa admissão**2630800**
Arandela 14 x 19 x 1,25mm
Arruela (Cobre)**2617600**
Arandela 16 x 22 x 1,5mm
Arruela (Cobre)**2702400**
O'ring 12,37 x 2,62mm**JC-322-15 - 7700866465**
Junta Cáster
Junta Carter**RT-2997Pol**
Retén Arbol de Levas
Ret. do Eixo Comando de Válvulas
28,00 x 47,00 x 8,00**RT-2977Pol**
Juego Ret. Guía de Válvulas
Jogo Retentor da Haste de Válvulas**1404700**
Bomba de aceite
Bomba de óleo**1180900**
Bomba de agua
Bomba de água**RT-9771Vit**
Retén Bancada
Ret. Traseiro do Virabrequim
Mx-R 70,00 x 86,00 x 7**2730300**
Chupador bomba de aceite
Pescador bomba óleo**2764600**
Salida bomba de agua
Saída bomba de água**RT-9802Vit**
Retén Distribución
Retentor Dianteiro do Virabrequim
Lx-R 32,00 x 44,00 x 6,00

Productos relacionados no incluidos en el juego. Los mismos pueden ser solicitados por separado.

Produtos relacionados não incluídos no jogo. Podem ser solicitados em separado.

Related products that were not included in the set but can be ordered separately.

**BU-059**
Bulones para
Culata de Cilindros
Parafusos de Cabeçote**BU-123**
Bulones para
Culata de Cilindros
Parafusos de Cabeçote

DESCRIPCIÓN / Descrição / Description

RENAULT: 728 - 708 - Clio II 2005/...
Twingo 2004/...

MOTOR / Engine	CM ³	HP	Ø PISTON
D4F 728/708 (DOHC) 16V	1149	75	69.00

Juego Completo de Reparación:

Jogo de Juntas do Motor / Full Set Gasket:

JR-426

R

Semi-Juego de Reparación:

Semi-Jogo de Juntas / Semi-Set Gasket:

SJ-426

R

Juego de Descarbonización:

Jogo de Juntas Superior / Head Set Gasket:

JD-426

R

JUNTA CULATA DE CILINDROS	TC-886-15	Ø 70.00mm	1.00mm	1.00mm	1.00mm
Junta de cabeçote	TC-886-MG	Ø 70.00mm	1.00mm	1.00mm	1.00mm
Cylinder Head gasket	TC-886-18	Ø 70.00mm	2.300mm	2.300mm	2.300mm



JD-426

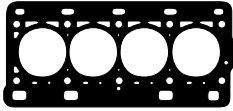

TC-886 - 8200086698
Junta Culata de Cilindros
Junta Cabeçote

2753600
O'ring 20 x 1,8mm

2630800
Arandela 14 x 19 x 1,25mm
Arruela (Cobre)



JAE-513-E - 8200310867
Junta Escape
Junta Escapamento

JAE-514-A - 7701473007
Juego Admisión
Jogo Admissão

2617600
Arandela 16 x 22 x 1,5mm
Arruela (Cobre)



JVS-355-43 - 7701059314
Junta Tapa de Válvula Superior
Junta Tampa de Válvula Superior



2730500 - 7701049890
Tapa caja admisión
Tampa caixa admissão

2702400
O'ring 12,37 x 2,62mm



JC-322-15 - 7700866465
Junta Carter
Junta Carter

RT-2997Pol
Retén Árbol de Levas
Ret. do Eixo Comando de Válvulas
28,00 x 47,00 x 8,00

RT-2977Pol
Juego Ret. Guía de Válvulas
Jogo Retentor da Haste de Válvulas



1404700
Bomba de aceite
Bomba de óleo



1180900
Bomba de agua
Bomba de água



RT-9771Vit
Retén Bancada
Ret. Traseiro do Virabrequim
Mx-R 70,00 x 86,00 x 7



2730300
Chupador bomba de aceite
Pescador bomba óleo



2764600
Salida bomba de agua
Saída bomba de água



RT-9802Vit
Retén Distribución
Retentor Dianteiro do Virabrequim
Lx-R 32,00 x 44,00 x 6,00

Productos relacionados no incluidos en el juego. Los mismos pueden ser solicitados por separado.

Produtos relacionados não incluídos no jogo. Podem ser solicitados em separado.

Related products that were not included in the set but can be ordered separately.



BU-123
Bulones para Culata de Cilindros
Parafusos de Cabeçote



JSA-326-21
Junta salida escape
Junta saída escapamento

Juego Completo de Reparación:

Jogo de Juntas do Motor / Full Set Gasket:

JR-212-15

DESCRIPCIÓN / Descrição / Description

RENAULT: Clio - R19 1990/98 - Kangoo Express 1990/95 - Megane**Semi-Juego de Reparación:**

Semi-Jogo de Juntas / Semi-Set Gasket:

SJ-112**Juego de Descarbonización:**

Jogo de Juntas Superior / Head Set Gasket:

JD-212-15

JUNTA CULATA DE CILINDROS	TC-333-15	∅ 77.40mm	1.50mm	↑ ↓
Junta de cabeçote	TC-333-18	∅ 77.40mm	2.30mm	↑ ↓
Cylinder Head gasket				↑ ↓

MOTOR / Engine	CM ³	HP	∅ PISTON
E5F/E7F	1171	55/60	75.80
E6J/E7J Energy	1390	77/80	75.80

ILLINOIS

RENAULT

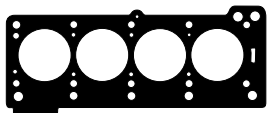
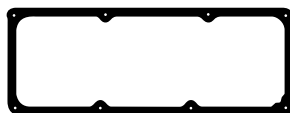
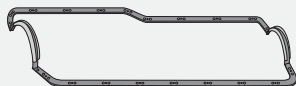
**JD-212-15****TC-333-15**
Junta Culata de Cilindros
Junta Cabeçote**JAE-376-E** - 7700854041/7700867360
Junta Escape
Junta Escapamento**JAE-534-A**
Junta Admisión
Junta Admissão**JVS-290-34** - 7700854640
Junta Tapa Válvula Superior
Junta Tampa Válvula Superior**JAE-377-A** - 7700749824
Junta Admisión
Junta Admissão**RT-622Pol**
Juego Retenes Guía de Válvulas
Jogo Retentor da Haste de Válvulas**RT-6690Pol**
Retén Árbol de Levas
Ret. do Eixo Comando de Válvulas
Lz-R 30,00 x 42,00 x 7,00**JC-318-43** - 7700739392
Junta Carter
Junta Carter**1182400**
Tapa bomba de agua
Tampa bomba de água**1182600** - 7700851497
Tapa bomba de nafta
Tampa bomba de gasolina**2745400** - 7700575468
7701348178
Juego suplemento camisa
Jogo suplemento camisa
(Silicona/Silicone)**2740400**
O'ring 36,2 x 2,6mm**1182700**
Bomba de nafta
Bomba de gasolina**2614100**
Arandela 16 x 22 x 1mm
Arruela (Cobre)**RT-8505Vit**
Retén Bancada
Retentor Traseiro do Virabrequim
Lx-R 80,00 x 100,00 x 8,50**RT-6885Pol**
Retén Distribución
Retentor Dianteiro do Virabrequim
Lx-r 35,00 x 47,00 x 7,00

Productos relacionados no incluidos en el juego. Los mismos pueden ser solicitados por separado.

Produtos relacionados não incluídos no jogo. Podem ser solicitados em separado.

Related products that were not included in the set but can be ordered separately.

**BU-040**
Bulones para Culata de Cilindros
Parafusos de Cabeçote**JB-227**
Juego Carburador
Jogo Carburador

DESCRIPCIÓN / Descrição / Description

RENAULT: Twingo - Clio - Express 1992/...

MOTOR / Engine	CM ³	HP	Ø PISTON
C3G	1239	55	74.00

Juego Completo de Reparación:

Jogo de Juntas do Motor / Full Set Gasket:

JR-371-15



Semi-Juego de Reparación:

Semi-Jogo de Juntas / Semi-Set Gasket:

SJ-371



Juego de Descarbonización:

Jogo de Juntas Superior / Head Set Gasket:

JD-371-15



JUNTA CULATA DE CILINDROS	TC-414-15	Ø 77.00mm	1.60mm	1.60mm
Junta de cabeçote	TC-414-18	Ø 77.00mm	2.30mm	2.30mm
Cylinder Head gasket				



JD-371-15

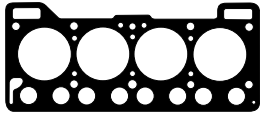

TC-414-15 - 7702080611
7702023675
Junta Culata de Cilindros
Junta Cabeçote



1078300 - 7700519278
Câmara agua
Câmara água



1109700 - 7702080617
Bomba de água
Bomba d'água



JAE-396-09 - 7700697874
Múltiple Admisión y Escape
Coletor Admissão e Escapamento



1109800 - 7702080654
7702070195/7701349269
Bomba de água
Bomba de água

RT-560Pol
Juego Retenes Guía de Válvulas
Jogo Retentor da Haste de Válvulas

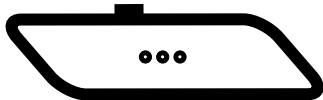

JVS-259-43 - 7701036311/0555497400
Junta Tapa Válvula Superior c/arandelas
Junta Tampa Válvula Superior c/arruelas



1199100
Base bomba de nafta
Base bomba de gasolina



1078500 - 7700517276
0607155200
Bomba de aceite
Bomba de óleo

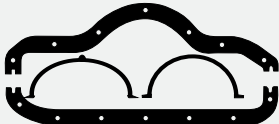

JC-281-30 - 7702070195
7702217454
Junta Cártér
Junta Carter



1077800 - 7702057213
Tapa distribución
Tampa distribuição



1199200
Bomba de nafta a block
Bomba de gasolina ao bloco



2745400 - 7700575468
7701348178
Juego suplemento camisa
Jogo suplemento camisa
(Silicona/Silicone)



1199300
Brida
Flange



1109400 - 0607155700
Base distribuidor
Base distribuidor

2621000 - Juego Arandelas Metálicas/Jogo Arruelas Metálicas

Gráfico	Descripción/Descrição	Cant./Quant.
	Ar./Arru. blindada 16x22mm Cobre	2
	Aran./Arruela 14x20x1,5mm Cobre	1
	Aran./Arruela 8x14x1mm Aluminio	1

RT-8505Vit
Retén Bancada
Retentor Traseiro
do Virabrequim
Lx-R 80,00 x 100,00 x 8,5

RT-8130Pol
Retén Distribución
Ret. Dianteiro do Virabrequim
Lx-R 35,00 x 50,00 x 8,00

Productos relacionados no incluidos en el juego. Los mismos pueden ser solicitados por separado.

Produtos relacionados não incluídos no jogo. Podem ser solicitados em separado.

Related products that were not included in the set but can be ordered separately.



BU-038
Bulones para
Culata de Cilindros
Parafusos de Cabeçote



JB-255-INY
Juego Carburador
Jogo Carburador



JC-281-23
7702070195/7702217454
Junta Cártér
Junta Carter

Juego Completo de Reparación:

Jogo de Juntas do Motor / Full Set Gasket:

JR-213-15**Semi-Juego de Reparación:**

Semi-Jogo de Juntas / Semi-Set Gasket:

SJ-216**Juego de Descarbonización:**

Jogo de Juntas Superior / Head Set Gasket:

JD-112-15

JUNTA CULATA DE CILINDROS	TC-378-15	Ø 75.00mm	1.60mm	1.60mm	1.60mm
Junta de cabeçote	TC-378-18	Ø 75.00mm	2.30mm	2.30mm	2.30mm
Cylinder Head gasket					

DESCRIPCIÓN / Descrição / Description

RENAULT: R12 - R4L - R4S - R6 - R4 1969/...
 R12 TS - R15 1972/75 - Estafette - R10
 Rodeo - R5 1974/84

MOTOR / Engine	CM ³	HP	Ø PISTON
668.01/10-810.88	1289	54	73.00
810.01/02/03/05/19	1289	54/63	73.00

ILLINOIS

RENAULT

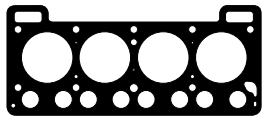
**JD-112-15**
TC-378-15 - 7700509107/7702056020
 Junta Culata de Cilindros
 Junta Cabeçote

1077200 - 0607332300
 Base carburador
 Base carburador

JSA-158
 7702024218
 Salida Escape
 Saída Escapamento

JAE-276 - 7702057848/7702087232
 Múltiple Admisión y Escape
 Coletor Admissão e Escapamento

1078400 - 7700524853
 Base carburador
 Base carburador

1077300 - 0857714400
 Cámara de agua
 Câmara água

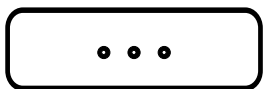
1077600 - 7700513015
 Bomba de agua
 Bomba de água

JVS-216-43 - 0555497400/7702206408
 Junta Tapa Válvula Superior
 c/arandelas
 Junta Tampa Válvula Superior c/aruelas

1078700 - 7702020652
 Bomba de agua
 Bomba de água

1077500 - 7700513014
 Tapa bomba de agua
 Tampa bomba de água

RT-523Pol
 Juego Retenes Guía de Válv.
 Jogo Retentor da Haste
 de Válvulas

1078800 - 7702020130
 Tapón tapa válvula
 Tampão tampa válvulas

1078300 - 7700519278
 7704000287
 Cámara agua
 Câmara água

1078600 - 7702020651
 Bomba de agua lateral
 Bomba de água lateral

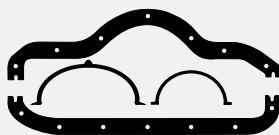
RT-6882Pol
 Retén Arbol de Levas
 Retentor do Eixo
 Comando de Válvulas
 Lx-R 30,00 x 42,00 x 7,00

JC-221-30 - 1018413
 Junta Carter
 Junta Carter

1077800 - 7702057213
 Tapa distribución
 Tampa distribuição

1078200 - 7700517376
 0857726400
 Bomba de aceite
 Bomba de óleo

1078500 - 7700517276
 0607155200
 Bomba de aceite
 Bomba de óleo

1077100 - 0602349600
 7702023292
 Bomba de nafta
 Bomba de gasolina

RT-6677Pol
 Retén Bancada
 Ret. Traseiro do Virabrequim
 Lx-R 70,00 x 90,00 x 10,00

RT-8006Pol
 Retén Distribución
 Retentor Dianteiro do Virabrequim
 A156-R 35,00 x 50,00 x 10,00

Productos relacionados no incluidos en el juego. Los mismos pueden ser solicitados por separado

Produtos relacionados não incluídos no jogo. Podem ser solicitados em separado / Related products that were not included in the set but can be ordered separately.

BU-038
 Bu. p/Cul. de Cilindros
 Parafusos de Cabeçote

JC-221-26 - (1,5mm)
JC-221-23
 Junta Carter

JB-156
 Juego Carburador
 Jogo Carburador

JB-208
 Juego Carburador
 Jogo Carburador

JV-127
 Juego Caja Velocidad
 Jogo Caixa de Câmbio

JV-128
 Juego Caja Velocidad
 Jogo Caixa de Câmbio

1149600 - R6007
 Suplemento Camisa
 (Jgo. x 4)(0,07mm)

1149700 - R6010
 Suplemento Camisa
 (Jgo. x 4)(0,10mm)

JB-179
 Juego Carburador
 Jogo Carburador

JB-155
 Juego Carburador
 Jogo Carburador

JAE-276-09 - 7702057848
 Múltiple Admisión y Escape
 Coletor Admissão e Escapamento

JSA-158-11
 Salida Escape
 Saída Escapamento

DESCRIPCIÓN / Descrição / Description

RENAULT: K4J: Clio II 2001/... - Kangoo - Scenic 1999/...
Megane II 2003/... - Modus 2004/... K4M: Clio - Scenic
Megane - Symbol - Laguna 1998/00 - Fluence - Duster 838
Logan 2007/...
NISSAN: Platina 16V 2002/... (10101-00QAA)

MOTOR / Engine	CM ³	HP	Ø PISTON
K4J 16V	1390	95/98	79.50
K4M 16V	1598	110	79.50

Juego Completo de Reparación:

Jogo de Juntas do Motor / Full Set Gasket:

JR-343

R

Semi-Juego de Reparación:

Semi-Jogo de Juntas / Semi-Set Gasket:

SJ-343

R

Juego de Descarbonización:

Jogo de Juntas Superior / Head Set Gasket:

JD-343

R

JUNTA CULATA DE CILINDROS	Junta de cabeçote	Cylinder Head gasket	TC-334-15	TC-334-MG	TC-334-18	Ø	H	h	h	h
						80.50mm	1.50mm			
						80.50mm	1.50mm			
						80.50mm	2.30mm			



JD-343



TC-334 - 7701471886
7700112739
Junta Culata de Cilindros
Parafusos de Cabeçote



JAE-425-A
Junta Admisión
Junta Admissão



1191200
Ventilación tapa de válvulas
Ventilação tampa de válvulas



2765000
Caja mariposa admisión
Caixa borboleta admissão
O'ring 62,2 x 4,2mm

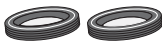

RT-9688Vit
Retén Árbol de Levas
Ret. do Eixo Comando de Válvulas
A156-R 28,00 x 42,00 x 5,00

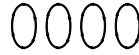

2735700 - 7700109421
Juego guarnición entre múltiple admisión
Jogo guarnição entre múltiplo admissão



JAE-422-E
Junta Escape
Junta Escapamento



1133000
Base termostato
Base termostato



2765200
Caja mariposa admisión
Caixa borboleta admissão
O'ring 68 x 8mm



RT-9643
Tapón Árbol de Levas
Tampão Eixo Comando de Válvulas
57,00 x 10,50



2735600 - 7700109420
Guarnición entre múltiple admisión
Guarnição entre múltiplo admissão



2765100
Base termostato
Base termostato



RT-2959Vit
Juego Retenes Guía Válvulas
Jogo Retentor da Haste de Válvulas



RT-9644
Tapón Árbol de Levas
Tampão Eixo Comando de Válv.
42,50 x 9,00



JC-323-43
Junta Cárter
Junta Carter



1191100
Bomba de agua
Bomba de água



2614000
Arandela 16 x 24 x 1mm
Arruela (Cobre)



RT-6885Pol
Retén Distribución
Ret. Dianteiro do Virabrequim
Lx-R 35,00 x 47,00 x 7,00



RT-8505Vit
Retén Bancada
Ret. Traseiro do Virabrequim
Lx-Hel 80,00 x 100,00 x 8,50

Productos relacionados no incluidos en el juego. Los mismos pueden ser solicitados por separado.

Produtos relacionados não incluídos no jogo. Podem ser solicitados em separado.

Related products that were not included in the set but can be ordered separately.



BU-041
Bulones para Culata de Cilindros
Parafusos de Cabeçote



JSA-231-21
Salida Escape (Anillo Malla Ac.)
Saída Escapamento (Anel Malha Aço)



JSA-231-22
Salida Escape
Saída Escapamento (Fundición/Ferro)



JSA-323
Salida Escape
Saída Escapamento



JSA-326-21
Salida Escape (Anillo Malla Ac.)
Saída Escapamento (Anel Malha Aço)



2735800
Juego Admisión
Jogo Admissão

Juego Completo de Reparación:

Jogo de Juntas do Motor / Full Set Gasket:

JR-344**Semi-Juego de Reparación:**

Semi-Jogo de Juntas / Semi-Set Gasket:

SJ-344**Juego de Descarbonización:**

Jogo de Juntas Superior / Head Set Gasket:

JD-344

JUNTA CULATA DE CILINDROS	TC-331-15	∅ 80.00mm	∓ 1.50mm	∓ 0.05
Junta de cabeçote	TC-331-MG	∅ 80.00mm	∓ 1.50mm	∓ 0.05
Cylinder Head gasket	TC-331-18	∅ 80.00mm	∓ 2.30mm	∓ 0.05

DESCRIPCIÓN / Descrição / Description

RENAULT: Megane - Scenic RN - Kangoo
Clio - Clio II 1995/... - Symbol - Sandero

MOTOR / Engine	CM ³	HP	∅ PISTON
K7J	1390	75	79.50
K7M-744/745	1598	75/90	79.50

ILLINOIS

RENAULT

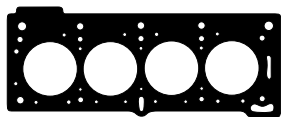
JD-344**TC-331 - 7700866683**
Junta Culata de Cilindros
Junta Cabeçote**JAE-467-A - 7700865764**
Junta Admisión
Junta Admissão**JVS-290-34 - 7700854640**
Junta Tapa Válvula Superior
Junta Tampa Válvula Superior**JC-327-43 - 7700273486**
7700862566
Junta Cáster
Junta Carter**1060200 - 7700272895**
Tapa trasera árbol de levas
Tampa traseira árvore de comando**JAE-376-E - 7700854041/7700867360**
Junta Escape
Junta Escapamento**2615800 - 7703062062**
Arandela 16 x 21 x 2mm
Arruela (Cobre)**JAE-599-A**
Juego Admisión
Jogo Admissão**1182600 - 7700851497**
Tapa bomba de nafta
Tampa bomba de gasolina**2711300 - 7700740028**
O'ring tubo llenado
tubo enchimento 40 x 5mm**RT-622Pol**
Juego Retenes Guía de Válvulas
Jogo Retentor da Haste de Válvulas**RT-6690Pol**
Retén Árbol de levas
Ret. do Eixo Comando de Válvulas
Lz-R 30,00 x 42,00 x 7,00**RT-8505Vit**
Retén Bancada
Retentor Traseiro do Virabrequim
Lx-R 80,00 x 100,00 x 8,50**RT-6885Pol**
Retén Distribución
Ret. Dianteiro do Virabrequim
Lx-r 35,00 x 47,00 x 7**1182400**
Tapa bomba de agua
Tampa bomba de água

Productos relacionados no incluidos en el juego. Los mismos pueden ser solicitados por separado.

Produtos relacionados não incluídos no jogo. Podem ser solicitados em separado.

Related products that were not included in the set but can be ordered separately.

**BU-040**
Bulones para Culata de Cilindros
Parafusos de Cabeçote**1174000**
7700865763
Caja Mariposa
Caixa Borboleta**JSA-264-21**
Salida Escape
Saída Escapamento**JSA-264-22**
Salida Escape
Saída Escapamento

DESCRIPCIÓN / Descrição / Description

RENAULT: Sandero 2008/... - Logan 2004/...

MOTOR / Engine	CM ³	HP	Ø PISTON
K7J-710/714 8V	1390	75	79.50
K7M-710/718 8V	1598	90	79.50

Juego Completo de Reparación:

Jogo de Juntas do Motor / Full Set Gasket:

JR-749



Semi-Juego de Reparación:

Semi-Jogo de Juntas / Semi-Set Gasket:

SJ-749



Juego de Descarbonización:

Jogo de Juntas Superior / Head Set Gasket:

JD-749



JUNTA CULATA DE CILINDROS	TC-952-15	Ø 80.20mm	1.50mm	1.50mm	1.50mm	1.50mm
Junta de cabeçote	TC-952-MG	Ø 80.20mm	1.50mm	1.50mm	1.50mm	1.50mm
Cylinder Head gasket						



JD-749

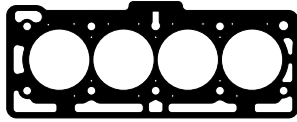

TC-952-8200296969
Junta Culata de Cilindros
Junta Cabeçote



1060200 - 7700272895
Tapa trasera árbol de levas
Tampa traseira árvore de comando



1182600 - 7700851497
Tapa bomba de nafta
Tampa bomba de gasolina



JAE-467-A - 7700865764
Junta Admisión
Junta Admissão



JAE-637-E - 8200191371
Junta Escape
Junta Escapamento



2711300 - 7700740028
O'ring tubo llenado
tubo enchimento 40 x 5mm

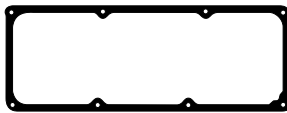

JVS-290-34 - 7700854640
Junta Tapa Válvula Superior
Junta Tampa Válvula Superior



JAE-599-A
Juego Admisión
Jogo Admissão



RT-622Pol
Juego Retenes Guía de Válvulas
Jogo Retentor da Haste de Válvulas

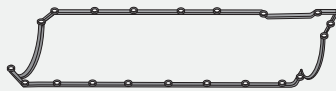

JC-327-43 - 7700273486
7700862566
Junta Cáster
Junta Carter

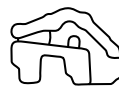

2765100
Base termostato
Base termostato



RT-6690Pol
Retén Árbol de levas
Ret. do Eixo Comando de Válvulas
Lz-R 30,00 x 42,00 x 7,00



1191100
Tapa bomba de agua
Tampa bomba de água



2615800 - 7703062062
Arandela
Arruela (Cobre)
16 x 21 x 2mm



RT-8505Vit
Retén Bancada
Retentor Traseiro do Virabrequim
Lx-R 80,00 x 100,00 x 8,50



RT-6885Pol
Retén Distribución
Ret. Dianteiro do Virabrequim
Lx-r 35,00 x 47,00 x 7

Productos relacionados no incluidos en el juego. Los mismos pueden ser solicitados por separado.

Produtos relacionados não incluídos no jogo. Podem ser solicitados em separado.

Related products that were not included in the set but can be ordered separately.



BU-242
Bulones para Culata de Cilindros
Parafusos de Cabeçote



1174000
7700865763
Caja Mariposa
Caixa Borboleta



JSA-264-21
Salida Escape
Saída Escapamento



JSA-264-22
Salida Escape
Saída Escapamento

Juego Completo de Reparación:

Jogo de Juntas do Motor / Full Set Gasket:

JR-253-15**Semi-Juego de Reparación:**

Semi-Jogo de Juntas / Semi-Set Gasket:

SJ-217**Juego de Descarbonización:**

Jogo de Juntas Superior / Head Set Gasket:

JD-122-15**JUNTA CULATA DE CILINDROS**

TC-414-15 77.00mm

1.60mm

Junta de cabeçote
Cylinder Head gasket

TC-414-18 77.00mm

2.30mm

DESCRIPCIÓN / Descrição / Description

DIESEL**RENAULT: R6 GTL - R12 TL/TS 1976/80**
R5 TX 1979/84 - Fuego - Traffic - Lecar Break
R18 GTL (Junior)

MOTOR / Engine

CM³

HP

Ø PISTON

847

1397

63/68

76.00

847/847.20/81

1397

48

76.00

ILLINOIS

RENAULT

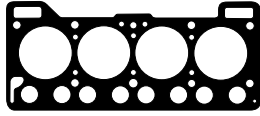
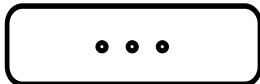
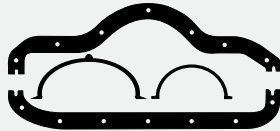
JD-122-15**TC-414-15** - 7702080611/7702023675
Junta Culata de Cilindros
Junta Cabeçote**JSA-158** - 7702024218
Salida Escape
Saída Escapamento**1077300** - 0857714400
Cámara de agua
Câmara água**1078600** - 7702020651
Bomba de agua lateral
Bomba de água lateral**JAE-276** - 7702057848/7702087232
Múltiple Admisión y Escape
Coletor Admissão e Escapamento**1078800** - 7702020130
Tapón tapa válvula
Tampão tampa válvula**1078400** - 7700524853
Base carburador
Base carburador**1078300** - 7700519278
7704000287
Cámara de agua
Câmara de água**JVS-216-43** - 0555497400/7702206408
Junta Tapa Válvula Superior c/arandelas
Junta Tampa Válvula Superior c/arruelas**1078700** - 7702020652
Bomba de agua
Bomba de água**RT-6882Pol**
Retén Arbol de Levas
Retenedor do Eixo Comando de Válvulas
Lx-R 30,00 x 42,00 x 7,00**RT-523Pol**
Juego Ret. Guía Válvulas
Jogo Retenedor da Haste de Válvulas**JC-221-30** - 1018413
Junta Carter
Junta Carter**1077800** - 7702057213
Tapa distribución
Tampa distribuição**1078500** - 7700517276
0607155200
Bomba de aceite
Bomba de óleo**1077100** - 0602349600
7702023292
Bomba de nafta
Bomba de gasolina**1078200** - 7700517376/0857726400
Bomba de aceite
Bomba de óleo**1132900** - 7702057895
Bomba de nafta
Bomba de gasolina**1109400** - 0607155700
Base distribuidor
Base distribuidor**RT-6677Pol**
Retén Bancada
Ret. Traseiro do Virabrequim
Lx-R 70,00 x 90,00 x 10,00**RT-8006Pol**
Retén Distribución
Ret. Dianteiro do Virabrequim
A156-R 35,00 x 50,00 x 10,00

Productos relacionados no incluidos en el juego. Los mismos pueden ser solicitados por separado

Produtos relacionados não incluídos no jogo. Podem ser solicitados em separado / Related products that were not included in the set but can be ordered separately.

**BU-038**
Bu. p/Culata de Cilindros
Parafusos de Cabeçote**JV-138**
Juego Caja Velocidad
Jogo Caixa de Câmbio**JB-165**
Juego Carburador
Jogo Carburador**JB-180**
Juego Carburador
Jogo Carburador**JSA-158-11**
Salida Escape
Saída Escapamento**1150700** - R-12007
Suplemento Camisa
(Jgo. x 4)(0,07mm)**1150800** - R-12010
Suplemento Camisa
(Jgo. x 4)(0,10mm)**JB-184**
Juego Carburador
Jogo Carburador**JB-238**
Juego Carburador
Jogo Carburador**JAE-276-09** - 7702057848
Múltiple Admisión y Escape
Coletor Admissão e Escap.**JC-221-26** - (1,5mm)
JC-221-23
Junta Carter/Junta Carter

DESCRIPCIÓN / Descrição / Description

RENAULT: R12 - R11 TL/TS - Junior 1984/...
Dacia TLX - R18 - Trafic 1982/... - Encore

MOTOR / Engine

CM³ HP Ø PISTON

847 1397 48 76.00

Juego Completo de Reparación:

Jogo de Juntas do Motor / Full Set Gasket:

JR-298-15

R

Semi-Juego de Reparación:

Semi-Jogo de Juntas / Semi-Set Gasket:

Juego de Descarbonización:

Jogo de Juntas Superior / Head Set Gasket:

JD-147-15

R

JUNTA CULATA DE CILINDROS
Junta de cabeçote
Cylinder Head gasket

TC-414-15

∅ 77.00mm

1.60mm

TC-414-18

∅ 77.00mm

2.30mm

±0.05

±0.05

±0.05

±0.05

±0.05

±0.05

±0.05

±0.05

±0.05

±0.05

±0.05

±0.05

±0.05

±0.05

±0.05

±0.05

±0.05

±0.05

±0.05

±0.05

±0.05

±0.05

±0.05

±0.05

±0.05

±0.05

±0.05

±0.05

±0.05

±0.05

±0.05

±0.05

±0.05

±0.05

±0.05

±0.05

±0.05

±0.05

±0.05

±0.05

±0.05

±0.05

±0.05

±0.05

±0.05

±0.05

±0.05

±0.05

±0.05

±0.05

±0.05

±0.05

±0.05

±0.05

±0.05

±0.05

±0.05

±0.05

±0.05

±0.05

±0.05

±0.05

±0.05

±0.05

±0.05

±0.05

±0.05

±0.05

±0.05

±0.05

±0.05

±0.05

±0.05

±0.05

±0.05

±0.05

±0.05

±0.05

±0.05

±0.05

±0.05

JD-147-15

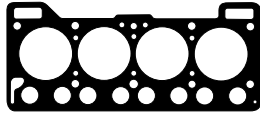

TC-414-15 - 7702080611/7702023675
Junta Culata de Cilindros
Junta Cabeçote



JSA-170 - 7702057996
Salida Escape
Saída Escapamento



JSA-158 - 7702024218
Salida Escape
Saída Escapamento



1078600 - 7702020651
Bomba de agua lateral
Bomba d'água lateral



JAE-276 - 7702057848/7702087232
Múltiple Admisión y Escape
Coletor Admissão e Escapamento



1077300 - 0857714400
Cámara de agua
Câmara água



1078400 - 7700524853
Base carburador
Base carburador



1078300 - 7700519278
7704000287
Cámara de agua
Câmara de água

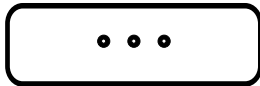

JVS-216-43 - 0555497400/770206408
Junta Tapa Válvula Superior c/arandelas
Junta Tampa Válvula Superior c/arruelas



1047800 - 0608201900
21081107990/7702086169
Base carburador
Base carburador



1078700 - 7702020652
Bomba de agua
Bomba de água



RT-560Pol
Juego Ret. Guía de Válvulas
Jogo Retenedor da Haste de Válvulas



RT-6882Pol
Retén Arbol de Levas
Retenedor do Eixo
Comando de Válvulas
Lx-R 30,00 x 42,00 x 7,00

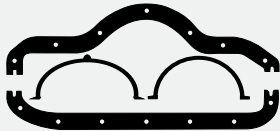

JC-281-30 - 7702070195/7702217454
Junta Cártier
Junta Carter



1078800 - 7702020130
Tapón tapa válvula
Tampão tampa válvula



1109400 - 0607155700
Base distribuidor
Base distribuidor



1078200 - 7700517376/0857726400
Bomba de aceite
Bomba de óleo



1078500 - 7700517276
0607155200
Bomba de aceite
Bomba de óleo



1132900 - 7702057895
Bomba de nafta
Bomba de gasolina



1077100 - 0602349600
7702023292
Bomba de nafta
Bomba de gasolina



1077800 - 7702057213
Tapa distribución
Tampa distribuição



2745400 - 7700575468
7701348178
Juego suplemento camisa
Jogo suplemento camisa
(Silicona/Silicone) (x4)



RT-8002Pol
Retén Bancada
Retenedor Traseiro
do Virabrequim
Lz-R 80,00 x 100,00 x 13,00



RT-8006Pol
Retén Distribución
Retenedor Dianteiro
do Virabrequim
A156-R 35,00 x 50,00 x 10,00

Productos relacionados no incluidos en el juego. Los mismos pueden ser solicitados por separado
Produtos relacionados não incluídos no jogo. Podem ser solicitados em separado / Related products that were not included in the set but can be ordered separately.



BU-038
Bu. p/Cul. Cilindros
Parafusos de Cabeçote



JB-250
Jgo.
Carburador



JB-221
Jgo.
Carburador



JB-248
Jgo.
Carburador



JAE-276-09
Múltiple Adm. y Escape
Coletor Adm. e Escap.



JAE-396-09
Múltiple Adm. y Escape
Coletor Adm. e Escap.



JC-281-23
Junta Cártier
Junta Carter



JSA-170-11
Salida Escape
Saída Escapam.



JSA-158-11
Salida Escape
Saída Escapam.

Juego Completo de Reparación:

Jogo de Juntas do Motor / Full Set Gasket:

JR-299-15**R****Semi-Juego de Reparación:**

Semi-Jogo de Juntas / Semi-Set Gasket:

Juego de Descarbonización:

Jogo de Juntas Superior / Head Set Gasket:

JD-299-15**R**

JUNTA CULATA DE CILINDROS	TC-414-15	∅ 77.00mm	1.60mm	↑ ↓
Junta de cabeçote	TC-414-18	∅ 77.00mm	2.30mm	↑ ↓
Cylinder Head gasket				↑ ↓

DESCRIPCIÓN / Descrição / Description

RENAULT: R9 1981/89 - R11 1983/89 - R19 R21 1988/93 - Super Cinco 1982/... - Alliance Encore

MOTOR / Engine	CM ³	HP	∅ PISTON
C1J - C2J	1397	60/67	76.00
C1J - C2J Turbo	1397	104/110	76.00

ILLINOIS

RENAULT

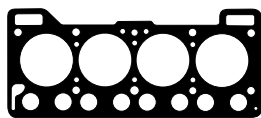
JD-299-15

TC-414-15 - 7702080611
7702023675
Junta Culata de Cilindros
Junta Cabeçote



JAE-329 - 7700697874
Múltiple Admisión y Escape
Coletor Admissão e Escapamento

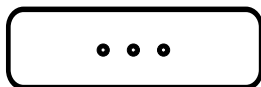

JVS-216-43 - 7702206408/0555497400
Junta Tapa Válvula Superior c/arandelas
Junta Tampa Válvula Superior c/arruelas

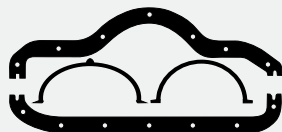

JC-281-30 - 7702070195/7702217454
Junta Cáster
Junta Carter



1077800 - 7702057213
Tapa distribución
Tampa distribuição



1078200 - 7700517376
0857726400
Bomba de aceite
Bomba de óleo



1078300 - 7700519278/7704000287
Cámara de agua
Câmara água



1078800 - 7702020130
Tapón tapa válvulas
Tampão tampa válvulas



1109500 - 7700536796
Base carburador 1 boca
Base carburador 1 boca



1109700 - 7702080617
Bomba de agua
Bomba de água



1110000 - 7704002238
Base carburador 2 bocas
Base carburador 2 bocas



1109800 - 7702080654
7702070195/7701349269
Bomba de agua
Bomba de água



RT-560Pol
Juego Ret. Guía de Válvulas
Jogo Retentor da Haste de Válvulas



RT-6882Pol
Retén Árbol de Levas
Ret. do Eixo Comando de Válv.
Lx-R 30,00 x 42,00 x 7,00



1132900 - 7702057895
Bomba de nafta
Bomba de gasolina



1077100 - 0602349600
7702023292
Bomba de nafta
Bomba de gasolina



RT-8002Pol
Bancada
Retentor Traseiro do Virabrequim
Lz-R 80,00 x 100,00 x 13,00



RT-8006Pol
Retén Distribución
Ret. Dianteiro do Virabrequim
A156-R 35,00 x 50,00 x 10,00

Productos relacionados no incluidos en el juego. Los mismos pueden ser solicitados por separado

Produtos relacionados não incluídos no jogo. Podem ser solicitados em separado / Related products that were not included in the set but can be ordered separately.



BU-038
Bul. p/Culata de Cilindros
Parafusos de Cabeçote



JV-138
Juego Caja Velocidad
Jogo Caixa de Câmbio



JSA-197-21
Salida Escape
Saída Escapamento



JSA-197-22
Salida Escape
Saída Escapamento



JAE-329-11 - 7700697874
Múltiple Admisión y Escape
Coletor Admissão e Escapamento



JAE-396-09
Múltiple Adm. y Escape
Coletor Admissão e Escap.



JB-198
Juego Carburador
Jogo Carburador



JB-199
Juego Carburador
Jogo Carburador



JB-202
Juego Carburador
Jogo Carburador



JB-222
Juego Carburador
Jogo Carburador



JAE-329-09 - 7700697874
Múltiple Admisión y Escape
Coletor Admissão e Escapamento



JC-281-23 - 7702070195
Junta Cáster
Junta Carter

DESCRIPCIÓN / Descrição / Description **DIESEL**

RENAULT: Clio II - Kangoo DCI 2001/...
Megane DCI 2002/... - Commonrail
NISSAN: Almera - Micra 2000/...

MOTOR / Engine	CM ³	HP	Ø PISTON
K9K	1461	65/82	76.00

Juego Completo de Reparación:

Jogo de Juntas do Motor / Full Set Gasket:

Semi-Juego de Reparación:

Semi-Jogo de Juntas / Semi-Set Gasket:

SJ-504

R

Juego de Descarbonización:

Jogo de Juntas Superior / Head Set Gasket:

JD-504-ST

R

JUNTA CULATA DE CILINDROS	TC-893 0M	Ø 77.30mm	± 0.85mm	± de 0,23 a 0,27mm
	TC-893 2M	Ø 77.30mm	± 1.00mm	± de 0,28 a 0,45mm
Junta de cabeçote	TC-893 1M	Ø 77.30mm	± 1.20mm	± de 0,46 a 0,71mm
Cylinder Head gasket	TC-893 3M	Ø 77.30mm	± 1.40mm	± de 0,72mm ...

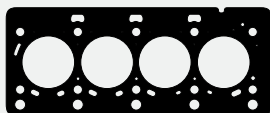

TC-893-20 0M TC-893-MG 0M
TC-893-20 2M TC-893-MG 2M
TC-893-20 1M TC-893-MG 1M
TC-893-20 3M TC-893-MG 3M
Junta Culata de Cilindros
Junta Cabeçote



JAE-497-E - 8200128551
Junta Escape
Junta Escapamento



JVS-304-43
Junta Tapa Válvula Superior
Junta Tampa Válvula Superior



1094200 - 8800073003
Bomba depresora
Bomba depressora



JSA-109 - 7700836096
Salida Escape
Saída Escapamento



1099100
Descarga aceite turbo
Descarga óleo turbo



2726000
Arandela admisión
Arruela admissão
31,3 x 35,6 x 3mm



2736800 - 3469970445
O'ring 30,5 x 3,5mm



1099400
Entrada turbo
Entrada turbo



2726300 - 036133073
Arandela 64 x 69 x 5mm
Arruela (Sintético)



2702100
O'ring 25,07 x 2,62mm



2624600
Arandela 6 x 14 x 3mm
Arruela (Cobre)



2615800
Arandela 16 x 21 x 2mm
Arruela (Cobre)



2726400 - 7701047076
Arandela llenado aceite
Arruela enchimento de óleo
45 x 49 x 5mm



2740400
O'ring 36,2 x 2,62mm



2748200
Entrada y salida tubo admisión
Entrada e saída tubo admissão
O'ring 34,4 x 3,2mm



RT-594Pol
Juego Retenes Guía de Válvulas
Jogo Retentor da Haste de Válvulas



RT-9688Vit
Retén Árbol de Levas
Ret. do Eixo Comando de Válvulas
A156-R 28,00 x 42,00 x 5,00



JC-323-43 - 7700103687
Junta Cártel
Junta Carter



1094100 - 88001822129
Frente distribución
Frente distribuição



1094300 - 8200115278
Bomba de agua
Bomba de água

2727100 - Juego Arandelas de Goma/Jogo Arruelas de Borracha

Gráfico	Descripción/Descrição	Cant./Quant.
	O'ring 59,92x3,53mm 46428901	1
	O'ring 36,2x2,62mm	1
	O'ring 18,72x2,62mm	1
	O'ring 17x2,62mm	1
	O'ring 16x3mm	1



RT-6885Pol
Retén Distribución
Ret. Dianteiro do Virabrequim
Lx-R 35,00 x 47,00 x 7,00



RT-8505Vit
Retén Bancada
Retentor Traseiro do Virabrequim
Lx-R 80,00 x 100,00 x 8,50

Productos relacionados no incluidos en el juego. Los mismos pueden ser solicitados por separado.

Produtos relacionados não incluídos no jogo. Podem ser solicitados em separado.

Related products that were not included in the set but can be ordered separately.



BU-124
Bulones para Culata de Cilindros
Parafusos de Cabeçote



JT-119
Juego Turbo
Jogo Turbo



JSA-326-21
Salida Escape
Saída Escapamento

Juego Completo de Reparación:

Jogo de Juntas do Motor / Full Set Gasket:

Semi-Juego de Reparación:

Semi-Jogo de Juntas / Semi-Set Gasket:

Juego de Descarbonización:

Jogo de Juntas Superior / Head Set Gasket:

JUNTA CULATA DE CILINDROS	TC-893 0M	∅ 77.30mm	± 0.85mm	± 0.23 a 0.27mm
Junta de cabeçote	TC-893 2M	∅ 77.30mm	± 1.00mm	± 0.28 a 0.45mm
Cylinder Head gasket	TC-893 1M	∅ 77.30mm	± 1.20mm	± 0.46 a 0.71mm
	TC-893 3M	∅ 77.30mm	± 1.40mm	± 0.72mm ...

DESCRIPCIÓN / Descrição / Description

DIESEL

RENAULT: Megane II - Sandero - Symbol
Sandero Stepway - Logan 2006/...

MOTOR / Engine	CM ³	HP	∅ PISTON
K9K DCI (SOHC) 8V	1461	65/100	76.00

ILLINOIS

RENAULT



JD-532-ST

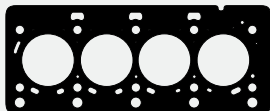

TC-893-20 0M TC-893-MG 0M
TC-893-20 2M TC-893-MG 2M
TC-893-20 1M TC-893-MG 1M
TC-893-20 3M TC-893-MG 3M
Junta Culata de Cilindros
Junta Cabeçote



JAE-542-E - 8200414346
Junta Escape
Junta Escapamento



JVS-304-43
Junta Tapa Válvula Superior
Junta Tampa Válvula Superior



1094200 - 8800073003
Bomba depresora
Bomba depressora



JSA-109 - 7700836096
Salida Escape
Saída Escapamento



1099100
Descarga aceite turbo
Descarga óleo turbo



2726000
Arandela admisión
Arruela admissão
31,3 x 35,6 x 3mm



2736800 - 3469970445
O'ring 30,5 x 3,5mm



1099400
Entrada turbo
Entrada turbo



2726300 - 036133073
Arandela 64 x 69 x 5mm
Arruela (Sintético)



2702100
O'ring 25,07 x 2,62mm



2726100
Entrada y salida tubo admisión
Entrada e saída tubo admissão
O'ring 34,5 x 3,2mm



2615800
Arandela 16 x 21 x 2mm
Arruela (Cobre)



1099600
Salida turbo catalizador
Saída turbo catalizador



2726400 - 7701047076
Arandela llenado aceite
Arruela enchimento de óleo
45 x 49 x 5mm



2740400
O'ring 36,2 x 2,62mm



2624600
Arandela 6 x 14 x 3mm
Arruela (Cobre)



RT-594Pol
Juego Retenes Guía de Válvulas
Jogo Retentor da Haste de Válvulas



RT-9688Vit
Retén Árbol de Levas
Ret. do Eixo Comando de Válvulas
A156-R 28,00 x 42,00 x 5,00

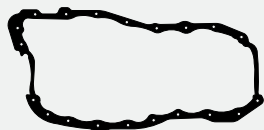

JC-409-43 - 8200379654
Junta Cártar
Junta Carter



1094100 - 88001822129
Frente distribución
Frente distribuição



1094300 - 8200115278
Bomba de agua
Bomba de água

2727100 - Juego Arandelas de Goma/Jogo Arruelas de Borracha

Gráfico	Descripción/Descrição	Cant./Quant.
	O'ring 59,92x3,53mm 46428901	1
	O'ring 36,2x2,62mm	1
	O'ring 18,72x2,62mm	1
	O'ring 17x2,62mm	1
	O'ring 16x3mm	1



RT-6885Pol
Retén Distribución
Retentor Dianteiro do Virabrequim
Lx-R 35,00 x 47,00 x 7,00



RT-8505Vit
Retén Bancada
Retentor Traseiro do Virabrequim
Lx-R 80,00 x 100,00 x 8,50

Productos relacionados no incluidos en el juego. Los mismos pueden ser solicitados por separado.

Produtos relacionados não incluídos no jogo. Podem ser solicitados em separado.

Related products that were not included in the set but can be ordered separately.



BU-124
Bulones para
Culata de Cilindros
Parafusos de Cabeçote



JT-119
Juego Turbo
Jogo Turbo



JSA-326-21
Salida Escape
Saída Escapamento

DESCRIPCIÓN / Descrição / Description **DIESEL**

RENAULT: Clio III/IV - Dokker - Duster
Fluence - Latitude - Logan - Sandero

MOTOR / Engine	CM ³	HP	Ø PISTON
K9K 608/612/770/820	1461	75	76.00
K9K 884/846	1461	90/95	76.00
K9K 856/858	1461	109	76.00
K9K 636/782/837	1461	110	76.00

Juego Completo de Reparación:

Jogo de Juntas do Motor / Full Set Gasket:

JR-650-11

R

Semi-Juego de Reparación:

Semi-Jogo de Juntas / Semi-Set Gasket:

Juego de Descarbonización:

Jogo de Juntas Superior / Head Set Gasket:

JUNTA CULATA DE CILINDROS	TC-693-11	Ø 77.50mm	0.90mm	↑ ↓
Junta de cabeçote		Ø	0.90mm	↑ ↓
Cylinder Head gasket		Ø	0.90mm	↑ ↓

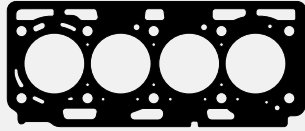

TC-693-11 - 110441845R
Junta Culata de Cilindros
Junta Cabeçote



Junta



Junta



Junta Tapa Válvula Superior
Junta Tampa Válvula Superior



Junta Escape
Junta Escapamento



Junta

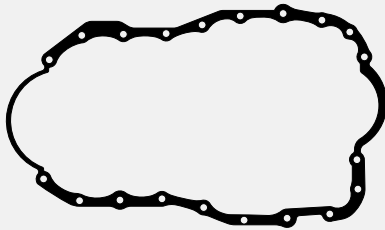

Junta Cártel
Junta Carter



Junta

Retén Bancada
Retentor Traseiro do
Virabrequim

Retén Distribución
Retentor Dianteiro
do Virabrequim

Retén Árbol de Levas
Retentor do Eixo Comando
de Válvulas

Juego Retenes Guía de Válvulas
Jogo Retentor da Haste de Válvulas

R

Productos relacionados no incluidos en el juego. Los mismos pueden ser solicitados por separado.

Produtos relacionados não incluídos no jogo. Podem ser solicitados em separado.

Related products that were not included in the set but can be ordered separately.

Juego Completo de Reparación:

Jogo de Juntas do Motor / Full Set Gasket:

JR-342-15

DESCRIPCIÓN / Descrição / Description

RENAULT: Trafic - R9 - R11 - R12 - R18 - R19
1988/... - Alliance - Encore (7702217513)**Semi-Juego de Reparación:**

Semi-Jogo de Juntas / Semi-Set Gasket:

SJ-342**Juego de Descarbonización:**

Jogo de Juntas Superior / Head Set Gasket:

JD-144-15

JUNTA CULATA DE CILINDROS	TC-529-15	Ø 78.00mm	1.60mm	↑ ↓
Junta de cabeçote	TC-529-18 <td>Ø 78.00mm <td>2.30mm <td>↑ ↓</td> </td></td>	Ø 78.00mm <td>2.30mm <td>↑ ↓</td> </td>	2.30mm <td>↑ ↓</td>	↑ ↓
Cylinder Head gasket				↑ ↓

MOTOR / Engine	CM ³	HP	Ø PISTON
C1L - C2L	1565		77.00
Carburador			

ILLINOIS

RENAULT

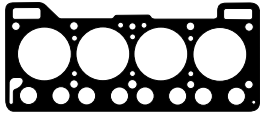
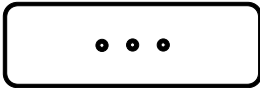
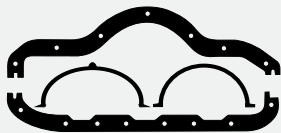
JD-144-15**TC-529-15** - 7702220799/7702217284
Junta Culata de Cilindros
Junta Cabeçote**JAE-396-09** - 7700697874
Múltiple Admisión y Escape
Coletor Admissão e Escapamento**JVS-242-43** - BD1M6584A/7702220551
Junta Tapa Válvula Superior c/arandelas
Junta Tampa Válvula Superior c/arruelas**1078800** - 7702020130
Tapón tapa válvula
Tampão tampa válvula**JSA-170** - 7702057996
Salida Escape
Saída Escapamento**1109700** - 7702080617
Bomba de agua
Bomba de água**1109800** - 7702080654
7702070195/7701349269
Bomba de agua
Bomba de água**RT-6882PoI**
Retén Arbol de Levas
Retenedor do Eixo Comando de Válvulas
Lx-R 30,00 x 42,00 x 7,00**1047800** - 0608201900
21081107990/7702086169
Base carburador
Base carburador**1077300** - 0857714400
Cámara de agua
Câmara água**1078300** - 7700519278/7704000287
Cámara de agua
Câmara água**RT-560PoI**
Juego Retenes Guía Válvulas
Jogo Retenedor da Haste de Válvulas**JC-296-30** - 77012206018/7702070195
Junta Carter
Junta Carter**1077800** - 7702057213
Tapa distribución
Tampa distribuição**2745400** - 7700575468
7701348178
Juego suplemento camisa
Jogo suplemento camisa
(Silicona/Silicone)**1077100** - 7702023292
0602349600
Bomba de nafta
Bomba de gasolina**1132900** - 7702057895
Bomba de nafta
Bomba de gasolina**1181200**
Base bomba de aceite
Base bomba de óleo**RT-8002PoI**
Retén Bancada
Retenedor Traseiro do Virabrequim
Lz-R 80,00 x 100,00 x 13,00**RT-8006PoI**
Retén Distribución
Retenedor Dianteiro do Virabrequim
A156-R 35,00 x 50,00 x 10,00

Productos relacionados no incluidos en el juego. Los mismos pueden ser solicitados por separado

Produtos relacionados não incluídos no jogo. Podem ser solicitados em separado / Related products that were not included in the set but can be ordered separately.

**BU-038**
Bul. p/Cul. Cilindros
Parafusos de Cabeçote**JV-154**
Jgo. Caja Vel.
Jogo Caixa de Câmbio**JB-223**
Jgo.
Carburador**JB-240**
Jgo.
Carburador**JC-296-26** - (1,5mm)
JC-296-23
Junta Carter
Junta Carter**JAE-276**
JAE-276-09
Múltiple Adm. y Esc.
Coletor Adm. e Escap.**JAE-329**
JAE-329-09
Múltiple Adm. y Esc.
Coletor Adm. e Escap.**JAE-329-11**
Múltiple Adm. y Esc.
Coletor Adm. e Escap.**JSA-170-11**
Salida Escape
Saída Escap.

DESCRIPCIÓN / Descrição / Description

RENAULT: R19 - Clio - Express (7702217284)

MOTOR / Engine	CM ³	HP	Ø PISTON
C3L Inyección	1597	74	76.00

Juego Completo de Reparación:

Jogo de Juntas do Motor / Full Set Gasket:

JR-372-15

R

Semi-Juego de Reparación:

Semi-Jogo de Juntas / Semi-Set Gasket:

SJ-268

R

Juego de Descarbonización:

Jogo de Juntas Superior / Head Set Gasket:

JD-170-15

R

JUNTA CULATA DE CILINDROS	TC-529-15	78.00mm	1.60mm
Junta de cabeçote	TC-529-18 <td>78.00mm <td>2.30mm</td> </td>	78.00mm <td>2.30mm</td>	2.30mm
Cylinder Head gasket			



JD-170-15

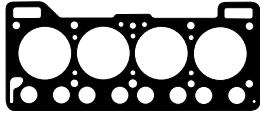

TC-529-15 - 7702220799/7702217284
Junta Culata de Cilindros
Junta Cabeçote



JAE-396-09 - 7700697874
Múltiple Admisión y Escape
Coletor Admissão e Escapamento

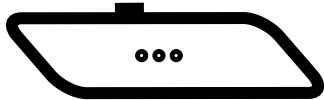

JVS-259-43 - 7701036311/0555497400
Junta Tapa Válvula Superior c/ arandelas
Junta Tampa Válvula Superior c/ arruelas



JSA-222 - 7700854668
Entre múltiple tubo primario
Entre coletor tubo primário



1173800 - 7700854391
Sobre múltiple
Sobre coletor



1109700 - 7702080617
Bomba de agua
Bomba de água



1109800 - 7702080654
7702070195/7701349269
Bomba de agua
Bomba de água



1173700 - 7700855273
Entre brida y múltiple admisión
Entre flange e coletor admissão



1078300 - 7700519278
Cámara de agua
Câmara de água



RT-560Pol
Juego Retenes Guía Válvulas
Jogo Retedor da Haste de Válvulas



RT-6882Pol
Retén Arbol de Levas
Ret. do Eixo Comando de Válvulas
Lx-R 30,00 x 42,00 x 7,00



2745400 - 7700575468
7701348178
Juego suplemento camisa
Jogo suplemento camisa
(Silicona/Silicone)

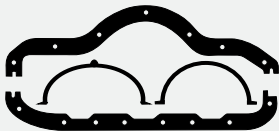

JC-296-30 - 77012206018/7702070195
Junta Cártar
Junta Carter



1077800 - 7702057213
Tapa distribución
Tampa distribuição



1132900 - 7702057895
Bomba de nafta
Bomba de gasolina



1174500 - 7700272725
Entre múltiple
Entre coletor



1077100 - 0602349600/7702023292
Bomba de nafta
Bomba de gasolina



2610800 - 0949484
Arandela 16 x 21 x 2mm
Arruela (Aluminio)



1181200
Base bomba de aceite
Base bomba de óleo



RT-8002Pol
Retén Bancada
Retedor Traseiro do Virabrequim
Lz-R 80,00 x 100,00 x 13,00



RT-8006Pol
Retén Distribución
Retedor Dianteiro do Virabrequim
Lx-R 35,00 x 50,00 x 10,00

Productos relacionados no incluidos en el juego. Los mismos pueden ser solicitados por separado.

Produtos relacionados não incluídos no jogo. Podem ser solicitados em separado.

Related products that were not included in the set but can be ordered separately.



BU-038
Bulones para Culata de Cilindros
Parafusos de Cabeçote



JB-256-INY
Juego Carburador
Jogo Carburador



1181100
7702229461
Base Múltiple Admisión
Base Coletor Admissão



JSA-262
Salida Escape
Saída Escapamento



JC-296-26 - (1,5mm)
JC-296-23
Junta Cártar
Junta Carter

Juego Completo de Reparación:

Jogo de Juntas do Motor / Full Set Gasket:

JR-359-15**R****Semi-Juego de Reparación:**

Semi-Jogo de Juntas / Semi-Set Gasket:

SJ-368**R****Juego de Descarbonización:**

Jogo de Juntas Superior / Head Set Gasket:

JD-359-15**R**

JUNTA CULATA DE CILINDROS	TC-594-15	∅ 81.50mm	1.50mm	↑ ↓
Junta de cabeçote				↑ ↓
Cylinder Head gasket				↑ ↓

DESCRIPCIÓN / Descrição / Description

RENAULT: R9 - R11 1986/89 - R19 1989/95

R21 - Trafic 1984/90 - Clio 1984/94

Súper Cinco 1986/91 - Alliance - Encore

VOLVO: 340 - 360

MOTOR / Engine	CM ³	HP	∅ PISTON
F2N - F3N	1721	75/94	81.00
F1N	1721	68/80	81.00
B172K	1721	80	81.00

ILLINOIS

RENAULT

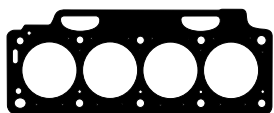
**JD-359-15**

TC-594-15 - 7700713860
Junta Culata de Cilindros
Junta Cabeçote



JAE-434 - 7700854539
Múltiple Admisión y Escape
Coletor Admissão e Escapamento



JVS-257-43 - 7700743903
7700719666
Junta Tapa Válvula Superior c/arandelas
Junta Tampa Válvula Superior c/arruelas



2740500 - 7700718380
Anillo termostato
Anel termostato



1172700 - 7700852434
Termostato



RT-561Pol
Juego Ret. Guía Válvulas
Jogo Retentor da Haste de Válvulas



RT-9891Vit
Retén Auxiliar
Retentor Auxiliar
Lx-R 22,00 x 45,00 x 8,00



RT-9607Vit
Retén Arbol de Levas
Ret. do Eixo Comando de Válvulas
Lx-R 25,00 x 42,00 x 7,00

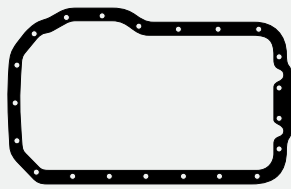

JC-307-15 - 7700859751
Junta Cártér (Cordón sellador)
Junta Carter (Cordão vedador)

2735900 - 7701349382
Lateral bancada
Lateral mancal



2740800
Guarnición gruesa
Guarnição grossa
65 x 4 x 5mm



2740600 - 7700736647
O'ring 31 x 3mm



2740700 - 7700736647
Guarnición fina
Guarnição fina
65 x 3 x 3,6mm



1072200 - 7703065088
7700622283
Base bomba de combustible
Base bomba de combustível



1158400 - 7700851213
Bomba de agua
Bomba de água



2701800
Lateral bancada
Lateral virabrequim
(Espesor/Espessura 5,10mm)



RT-6863Vit
Retén Bancada
Ret. Traseiro do Virabrequim
Lx-R 85,00 x 105,00 x 12,00



RT-6883Pol
Retén Distribución
Ret. Dianteiro do Virabrequim
Lx-R 50,00 x 68,00 x 10,00

2612700 - Juego Arandelas Metálicas/Jogo Arruelas Metálicas

Gráfico	Descripción/Descrição	Cant./Quant.
○	Ar./Arru. blindada 22x28x2,5mm Cobre	1
○	Ar./Arru. blindada 18x23x2,5mm Cobre	2
○	Ar./Arru. blindada 16x22mm Cobre	1
○	Ar./Arru. 15x21x2mm Cobre	2
○	Ar./Arru. 12x17x1mm Cobre	1
○	Ar./Arru. 10x15x2,5mm Cobre	1

Productos relacionados no incluidos en el juego. Los mismos pueden ser solicitados por separado.

Produtos relacionados não incluídos no jogo. Podem ser solicitados em separado.

Related products that were not included in the set but can be ordered separately.



BU-037
Bulones para Culata de Cilindros
Parafusos Cabeçote



JC-307-26 - 7700859751
Junta Cártér
Junta Carter
(1,5mm)



JAE-434-11 - 7700854539
Múltiple Admisión y Escape
Coletor Admissão e Escapamento

DESCRIPCIÓN / Descrição / Description

RENAULT: Laguna N7Q/700/704 1994/99
Safrane N7Q/710/711 1996/99
Space N7Q 1996/...
VOLVO: S40/V40 B418S 1995/... - B4204S/4204T

MOTOR / Engine	CM ³	HP	Ø PISTON
B4184S	1731	115	83.00
N7Q 16V	1948	138/140	83.00
B4204S/T	1948	140	83.00
B4204T	1948	160	83.00

Juego Completo de Reparación:

Jogo de Juntas do Motor / Full Set Gasket:

JR-405-15



Semi-Juego de Reparación:

Semi-Jogo de Juntas / Semi-Set Gasket:

SJ-405



Juego de Descarbonización:

Jogo de Juntas Superior / Head Set Gasket:

JD-405-15



JUNTA CULATA DE CILINDROS	TC-412-15	Ø 85.00mm	1.70mm	1.70mm
Junta de cabeçote				
Cylinder Head gasket				



JD-405-15

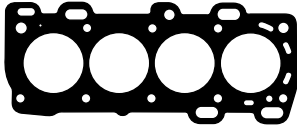

TC-412-15
Junta Culata de Cilindros
Junta Cabeçote



2708300 - 50031341
O'ring 50,52 x 1,78mm



1110400
Base termostato
Base termostato



JAE-527-E - 7439146313
Juego Escape
Jogo Escapamento



JAE-537-A - 7431366788
Junta Admisión
Junta Admissão



1110700 - 7700622283
Retorno agua
Retorno óleo



RT-620PoI
Juego Retenes Guía de Válvulas
Jogo Retentor da Haste de Válvulas



RT-9673Vit
Retén Arbol de Levas
Retentor do Eixo Comando de Válvulas
Mx-R 45,00 x 57,00 x 7,00



RT-9674Vit
Retén Arbol de Levas
Ret. do Eixo Comando de Válvulas
A 156-R 30,00 x 47,00 x 7,00



JC-377-26
Junta Carter
Junta Carter



1110600 - 7439135830
Tapa bomba de aceite
Tampa bomba de óleo



1109900 - 7431397532
Tapa bomba de agua
Tampa bomba de água



2702900
O'ring 32,5 x 3,5mm



2728500
O'ring 29,82 x 2,62mm



2700900
O'ring 20,3 x 2,62mm



2632100
Arandela tapón de cárter
19 x 24 x 1,5mm
Arruela tampão de carter(Aluminio)



RT-9671Vit
Retén Bancada
Retentor Traseiro do Virabrequim
A 285-R 98,00 x 110,00 x 8,50



RT-9672Vit
Retén Distribución
Ret. Dianteiro do Virabrequim
A 156-R 35,00 x 47,00 x 5,60

Productos relacionados no incluidos en el juego. Los mismos pueden ser solicitados por separado.

Produtos relacionados não incluídos no jogo. Podem ser solicitados em separado.

Related products that were not included in the set but can be ordered separately.



BU-173
Bulones para Culata de Cilindros
Parafusos de Cabeçote

Juego Completo de Reparación:

Jogo de Juntas do Motor / Full Set Gasket:

JR-514

DESCRIPCIÓN / Descrição / Description

RENAULT: Laguna 1998/... - Scenic - Master - Espace
Megane - Trafic 1999/... - Clio II - Kangoo
Clio II Sport 2001/... Duster 2011/...

NISSAN: Primastar 2002/... 16V

MOTOR / Engine	CM ³	HP	Ø PISTON
F4P 16V	1783	115/121	82.70
F4R 16V	1998	140/169	82.70

ILLINOIS

RENAULT

Semi-Juego de Reparación:

Semi-Jogo de Juntas / Semi-Set Gasket:

SJ-514**Juego de Descarbonización:**

Jogo de Juntas Superior / Head Set Gasket:

JD-514

JUNTA CULATA DE CILINDROS	TC-788-15	Ø 83.80mm	1.20mm	1.20mm	1.20mm	1.20mm
Junta de cabeçote	TC-788-MG	Ø 83.80mm	1.20mm	1.20mm	1.20mm	1.20mm
Cylinder Head gasket						

JD-514

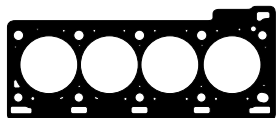

TC-788 - 7700108254
Junta Culata de Cilindros
Junta Cabeçote



1133000 - 7700104129
Base termostato
Base termostato

2702700
O'ring 28 x 3,5mm

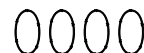

2735700 - 7700109421
Juego guarnición
entre múltiple admisión
Jogo guarnição entre
múltiplo admissão



JAE-493-E - 7700105843
Junta Escape
Junta Escapamento



JAE-494-A - 7700109906
Junta Admisión
Junta Admissão

2735600 - 7700109420
Guarnición entre múltiple admisión
Guarnição entre múltiplo admissão



RT-2959Pol
Juego Retenes Guía de Válvulas
Jogo Retentor da Haste de Válvulas

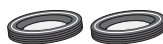

RT-2995Pol
Retén Árbol de Levas .../2009
Retentor do Eixo Comando de Válvulas
28,00 x 47,00 x 5,50



RT-2996Pol
Retén Árbol de Levas 2009/...
Retentor do Eixo Comando de Válvulas
35,00 x 47,00 x 6,00

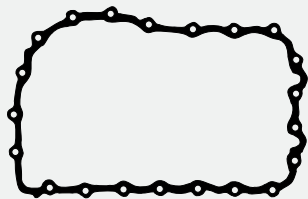

JC-320-43 - 7700108057
Junta Cáster
Junta Carter



RT-9643
Tapón Árbol de Levas
Tampão Eixo Comando de Válvulas
57,00 x 10,50



RT-9644
Tapón Árbol de Levas
Tampão Eixo Comando de Válvulas
42,50 x 9,00



1158400 - 7700851213
Bomba de agua
Bomba de água



2606800
Arandela blindada 10 x 15 x 2,5mm
Arruela blindada(Cobre)



RT-9656Vit
Retén Bancada
Retentor Traseiro do Virabrequim
A 275-R 85,00 x 105,00 x 11,00



RT-9606Vit
Retén Distribución
Retentor Dianteiro do Virabrequim
Lx-R 42,00 x 54,00 x 5,80



2723500
Arandela
Arruela
(Goma/Borracha - metal)



BU-194
Bulones para
Culata de Cilindros
Parafusos de Cabeçote

2735800
Juego Admisión
Jogo Admissão

Productos relacionados no incluidos en el juego. Los mismos pueden ser solicitados por separado.

Produtos relacionados não incluídos no jogo. Podem ser solicitados em separado.

Related products that were not included in the set but can be ordered separately.

DESCRIPCIÓN / Descrição / Description

RENAULT: R19 - Clio - Laguna 1991/98
VOLVO: 440 - 460 - 480 1991/97

MOTOR / Engine	CM ³	HP	Ø PISTON
F3P Inyección	1794	90	82.70
B18U	1794	90/113	82.70
B20F	1998	110/114	82.70

Juego Completo de Reparación:

Jogo de Juntas do Motor / Full Set Gasket:

JR-368-15



Semi-Juego de Reparación:

Semi-Jogo de Juntas / Semi-Set Gasket:

SJ-368



Juego de Descarbonización:

Jogo de Juntas Superior / Head Set Gasket:

JD-368-15



JUNTA CULATA DE CILINDROS	TC-595-15	Ø 83.50mm	1.50mm
Junta de cabeçote	TC-595-18	Ø 83.50mm	2.30mm
Cylinder Head gasket			



JD-368-15

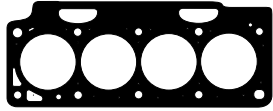

TC-595-15 - 7700859273
 Junta Culata de Cilindros
 Junta Cabeçote



JAE-434 - 7700854539
 Múltiple Admisión y Escape
 Coletor Admissão e Escapamento



JVS-257-43 - 7700743903
 7700719666
 Junta Tapa Válvula Superior c/arandelas
 Junta Tampa Válvula Superior c/arruelas



2740500 - 7700718380
 Anillo termostato
 Anel termostato



1172700 - 7700852434
 Termostato



RT-561Pol
 Juego Ret. Guía Válvulas
 Jogo Retentor da Haste de Válvulas



RT-9891Vit
 Retén Auxiliar
 Retentor Auxiliar
 Lx-R 22,00 x 45,00 x 8,00



RT-9607Vit
 Retén Arbol de Levas
 Ret. do Eixo Comando de Válvulas
 Lx-R 25,00 x 42,00 x 7,00

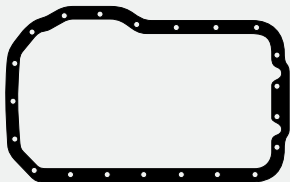

JC-307-15 - 7700859751
 Junta Cártier (Cordón sellador)
 Junta Carter (Cordão vedador)



2735900 - 7701349382
 Lateral bancada
 Lateral mancal



2740800
 Guarnición gruesa
 Guarnição grossa
 65 x 4 x 5mm



2740600 - 7700736647
 O'ring 31 x 3mm



2740700 - 7700736647
 Guarnición fina
 Guarnição fina
 65 x 3 x 3,6mm



1072200 - 7703065088
 7700622283
 Base bomba de combustible
 Base bomba de combustível



1158400 - 7700851213
 Bomba de agua
 Bomba de água



2701800
 Lateral bancada
 Lateral mancal
 (Espesor/Espessura 5,10mm)



RT-6863Vit
 Retén Bancada
 Retentor Traseiro do Virabrequim
 Lx-R 85,00 x 105,00 x 12,00



RT-6883Pol
 Retén Distribución
 Retentor Dianteiro do Virabrequim
 Lx-R 50,00 x 68,00 x 10,00

2612700 - Juego Arandelas Metálicas/Jogo Arruelas Metálicas

Gráfico	Descripción/Descrição	Cant./Quant.
	Ar./Arru. blindada 22x28x2,5mm Cobre	1
	Ar./Arru. blindada 18x23x2,5mm Cobre	2
	Ar./Arru. blindada 16x22mm Cobre	1
	Ar./Arru. 15x21x2mm Cobre	2
	Ar./Arru. 12x17x1mm Cobre	1
	Ar./Arru. 10x15x2,5mm Cobre	1

Productos relacionados no incluidos en el juego. Los mismos pueden ser solicitados por separado.

Produtos relacionados não incluídos no jogo. Podem ser solicitados em separado.

Related products that were not included in the set but can be ordered separately.



BU-036
BU-203
 Bulones p./ Culata de Cil.
 Parafusos de Cabeçote



JB-242-INY
 Juego/Jogo
 Carburador



JSA-247-21
 Salida Escape
 Saída Escapamento



JC-307-26 - 7700859751
 Junta Cártier
 Junta Carter
 (1,5mm)



JAE-434-11 - 7700854539
 Múltiple Admisión y Escape
 Coletor Admissão e Escapamento

Juego Completo de Reparación:

Jogo de Juntas do Motor / Full Set Gasket:

Semi-Juego de Reparación:

Semi-Jogo de Juntas / Semi-Set Gasket:

Juego de Descarbonización:

Jogo de Juntas Superior / Head Set Gasket:

JUNTA CULATA DE CILINDROS	TC-633 2M	Ø 81.10mm	1.65mm	... a 0,86mm
Junta de cabeçote	TC-633 1M	Ø 81.10mm	1.75mm	de 0,87 a 1,00mm
Cylinder Head gasket	TC-633 3M	Ø 81.10mm	1.85mm	de 1,01mm ...
	TC-633 4M	Ø 81.10mm	1.95mm	
	TC-633 5M	Ø 81.10mm	2.05mm	

DESCRIPCIÓN / Descrição / Description

DIESEL

RENAULT: R19 - Express - Clio - Kangoo
Trafic - Scenic - Megane

MOTOR / Engine	CM ³	HP	Ø PISTON
F8Q	1870	65	80.00

ILLINOIS

RENAULT

MENÚ

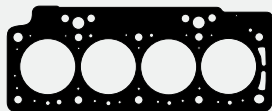

TC-633-20 2M **TC-633-MG 2M** - 7700867870
TC-633-20 1M **TC-633-MG 1M** - 7701039398
TC-633-20 3M **TC-633-MG 3M** - 7701039399
TC-633-20 4M **TC-633-MG 4M**
TC-633-20 5M **TC-633-MG 5M**
 Junta Culata de Cilindros
 Junta Cabeçote

JD-163-ST



1172700 - 7700852434
 Inferior árbol de levas
 Inferior árvore de comando



1165300 - 7700851849
 7700716769
 Bomba vacío
 Bomba vácuo



2729900
 Guarnición term. chica
 Guarnição termostato pequena



1158400 - 7700851213
 Bomba de agua
 Bomba d'água



1165900 - 7700859220
 Bomba vacío
 Bomba vácuo



2707300 - 7701040923
 Guarnición termostato
 Guarnição termostato



JAE-385-E - 7700854867
 Multiple Admisión y Escape
 Coletor Admissão e Escapamento



JVS-257-43 - 7700743903
 7700719666
 Junta Tapa Válvula Superior c/arrandelas
 Junta Tampa Válvulas Superior c/arruelas

2629100 - Juego Arandelas Metálicas/Jogo Arruelas Metálicas

Gráfico	Descripción/Descrição	Cant./Quant.
	Arandela blindada 22x28x2,5mm Cobre	1
	Arandela blindada 18x24x2,5mm Cobre	2
	Arandela blindada 16x22x2,5mm Cobre	1
	Arandela 15x21x2mm Cobre	4
	Arandela 12x17x1mm Cobre	1
	Arandela blindada 10x15x2,5mm Cobre	1
	Arandela con nervio 6x14mm Acero	4

2740500 - 7700718380
 Anillo termostato
 Anel termostato



RT-561PoI
 Juego Retenes
 Guía de Válvulas
 Jogo Retentor da Haste de Válvulas



RT-9607Vit
 Retén Arbol de Levas
 Retentor do Eixo
 Comando de Válvulas
 Lx-R 25,00 x 42,00 x 7,00

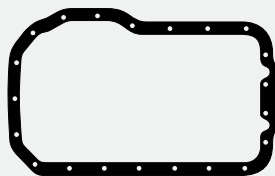

JC-307-15 - 7700859751
 Junta Cártér (Cordón sellador)
 Junta Carter (Cordão Vedador)



1095100
 Porta retén distribución
 Flange retentor distribuição



1133400 - 8200105746
 Porta retén distribución
 Flange retentor distribuição

2740600 - 7700736647
 O'ring 31 x 3mm



2707400 - 7701030255
 7701046634
 O'ring 74 x 3mm Bomba vacío
 Bomba vácuo



2735900 - 7701349382
 Lateral bancada
 Lateral virabrequiml



2701800
 Lateral bancada
 Lateral mancal
 (Espesor/Espessura 5,1mm)



2740800
 Guarnición gruesa
 Guarnição grossa
 65 x 73 x 5mm



2740700 - 7700736647
 Guarnición fina
 Guarnição fina
 65 x 71 x 3,6mm



RT-9196Vit
 Retén Bancada
 Retentor Traseiro do Virabrequim
 Lx-R 85,00 x 105,00 x 8,00



RT-8003PoI
 Retén Auxiliar
 Retentor Auxiliar
 Lx-R 30,00 x 40,00 x 7,00



RT-6883PoI
 Retén Distribución
 Retentor Dianteiro do Virabrequim
 Lx-R 50,00 x 68,00 x 10,00

Productos relacionados no incluidos en el juego. Los mismos pueden ser solicitados por separado.

Produtos relacionados não incluídos no jogo. Podem ser solicitados em separado.

Related products that were not included in the set but can be ordered separately.



BU-036
 Bulones para Culata de Cilindros
 Parafusos de Cabeçote



BU-037
 Bulones para Culata de Cilindros
 Parafusos de Cabeçote



BU-203
 Bulones para Culata de Cilindros
 Parafusos de Cabeçote



JC-307-26
 Junta Cártér
 Junta Carter
 (1,5mm)



JSA-262
 Salida Escape
 Saída Escapamento

DESCRIPCIÓN / Descrição / Description **DIESEL**

**RENAULT: R19 - Express - Clio II- Kangoo
Trafic - Scenic - Megane - Rodeo
(Cárter de Aluminio)**

MOTOR / Engine	CM ³	HP	Ø PISTON
F8Q Iny. Directa ①	1870	65	80.00
F8Q Iny. Indirecta ②	1870	65	80.00

Juego Completo de Reparación:

Jogo de Juntas do Motor / Full Set Gasket:

Semi-Juego de Reparación:

Semi-Jogo de Juntas / Semi-Set Gasket:

SJ-367

R

Juego de Descarbonización:

Jogo de Juntas Superior / Head Set Gasket:

JD-163-ST

R

JUNTA CULATA DE CILINDROS

Junta de cabeçote

Cylinder Head gasket

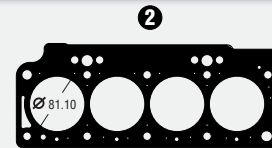
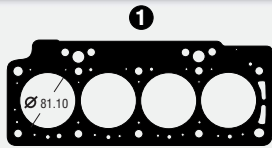

- TC-633-20 2M TC-633-MG 2M - 7700867870 (1.65mm)
- TC-633-20 1M TC-633-MG 1M - 7701039398 (1.75mm)
- TC-633-20 3M TC-633-MG 3M - 7701039399 (1.85mm)
- TC-633-20 4M TC-633-MG 4M (1.95mm)
- TC-633-20 5M TC-633-MG 5M (2.05mm)

Junta Culata de Cilindros Inyección Directa
Junta Cabeçote Injeção Direta

- TC-663-20 2M TC-663-MG 2M (1.40mm)
- TC-663-20 1M TC-663-MG 1M (1.50mm)
- TC-663-20 3M TC-663-MG 3M (1.60mm)
- TC-663-20 4M TC-663-MG 4M (1.70mm)
- TC-663-20 5M TC-663-MG 5M (1.80mm)

Junta Culata de Cilindros Inyección Indirecta
Junta Cabeçote Injeção Indireta

JD-163-ST



JAE-385-E - 7700854867
Multiple Admisión y Escape
Coletor Admissão e Escapamento



1165900 - 7700859220
Bomba vacío
Bomba vácuo



2729900
Guarnición termostato chica
Guarnição termostato pequena



2740500 - 7700718380
Anillo termostato
Anel termostato



JVS-257-43 - 7700743903
7700719666

Junta Tapa Válvula Superior c/arandelas
Junta Tampa Válvula Superior c/arruela



1165300 - 7700851849
7700716769
Bomba vacío
Bomba vácuo



2707300 - 7701040923
Guarnición termostato
Guarnição termostato



1172700 - 7700852434
Inferior árbol de levas
Inferior árvore de comando

2629100 - Juego Arandelas Metálicas/Jogo Arruelas Metálicas

Gráfico	Descripción/Descrição	Cant./Quant.
	Ar./Arru. blindada 22x28x2,5mm Cobre	1
	Ar./Arru. blindada 18x24x2,5mm Cobre	2
	Ar./Arru. blindada 16x22x2,5mm Cobre	1
	Ar./Arruela 15x21x2mm Cobre	4
	Ar./Arruela 12x17x1mm Cobre	1
	Ar./Arru. blindada 10x15x2,5mm Cobre	1
	Ar./Arru. c/nervio/nervo 6x14mm Acero	4



RT-561Pol
Juego Retenes Guía Válvulas
Jogo Retenitor da Haste de Válvulas



1158400 - 7700851213
Bomba de agua
Bomba de água



RT-9607Vit
Retén Árbol de Levas
Ret. do Eixo Comando de Válv.
Lx-R 25,00 x 42,00 x 7,00



2740800
Guarnición gruesa
Guarnição grossa
65 x 4 x 5mm

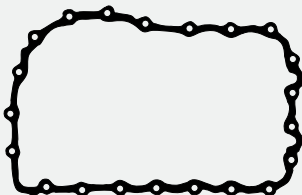

JC-320-43 - 7700108057
Junta Cárter (Aluminio)
Junta Carter



2701800
Lateral bancada
Lateral mancal
(Espesor 5,1mm)



2740700 - 7700736647
Guarnición fina
Guarnição fina
65 x 3 x 3,6mm



1133400 - 8200105746
Porta retén distribución
Porta retenitor distribuição



2735900 - 7701349382
Lateral bancada
Lateral mancal



2740600 - 7700736647
O'ring 31 x 3mm



2707400 - 7701030255
7701046634
O'ring 74 x 3mm Bomba vacío
Bomba vácuo



1095100
Porta retén distribución
Flange retenitor distribuição



RT-9656Vit
Retén Bancada
Retenitor Traseiro do Virabrequim
A 275-R 85 x 105 x 6,80/11,00



RT-8003Pol
Retén Auxiliar
Retenitor Auxiliar
Lx-R 30,00 x 40,00 x 7,00



RT-9606Vit
Retén Distribución
Retenitor Dianteiro do Virabrequim
Lx-R 42,00 x 54,00 x 5,80

Productos relacionados no incluidos en el juego. Los mismos pueden ser solicitados por separado

Produtos relacionados não incluídos no jogo. Podem ser solicitados em separado / Related products that were not included in the set but can be ordered separately.



BU-036
Bu. p/Cul. de Cil.
Parafusos Cabeçote



BU-037
Bu. p/Cul. de Cil.
Parafusos Cabeçote



BU-039
Bu. p/Cul. de Cil.
Parafusos Cabeçote



JSA-231-21
Salida Escape
Saída Escapam.



JSA-231-22
Salida Escape
Saída Escapam.



JSA-262
Salida Escape
Saída Escapam.



2712800
Guarn. Bomba
Depresora Pierburg



2712700
Guarn. Bomba
Depresora

Juego Completo de Reparación:

Jogo de Juntas do Motor / Full Set Gasket:

Semi-Juego de Reparación:

Semi-Jogo de Juntas / Semi-Set Gasket:

SJ-384

R

Juego de Descarbonización:

Jogo de Juntas Superior / Head Set Gasket:

JD-384-ST

R

JUNTA CULATA DE CILINDROS	TC-673 2M	Ø 81.10mm	1.40mm	... a 0,65mm
Junta de cabeçote	TC-673 1M	Ø 81.10mm	1.50mm	de 0,66 a 0,79mm
Cylinder Head gasket	TC-673 3M	Ø 81.10mm	1.60mm	de 0,80mm ...
	TC-673 4M	Ø 81.10mm	1.70mm	
	TC-673 5M	Ø 81.10mm	1.80mm	

DESCRIPCIÓN / Descrição / Description

DIESEL

RENAULT: Megane DTI/RN/RT - Scenic - Space - Traffic - Laguna 716/730/734 - Clio - Kangoo - Master
MITSUBISHI: Spacestar - Carisma
NISSAN: Interstar - Primera - Primastar
VOLVO: S40-V40 TD

MOTOR / Engine	CM ³	HP	Ø PISTON
F9Q Turbo	1870	80/100	80.00
Inyección Directa			

ILLINOIS

RENAULT

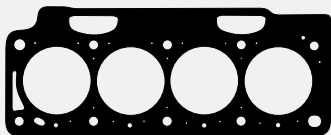

TC-673-20 2M TC-673-MG 2M - 7700105392/7700115822
TC-673-20 1M TC-673-MG 1M - 7700667325/7700859059/7700115822
TC-673-20 3M TC-673-MG 3M - 7700105393/7700115822
TC-673-20 4M TC-673-MG 4M
TC-673-20 5M TC-673-MG 5M
 Junta Culata de Cilindros / Junta Cabeçote

JD-384-ST

272990 Guarnición termostato chica
 Guarnição termostato pequena

2707300 7701040923
 Guarnición termostato
 Guarnição termostato

2740500 7700718380
 Anillo termostato
 Anel termostato

2618400 - Juego Arandelas Metálicas/Jogo Arruelas Metálicas

Gráfico	Descripción/Descrição	Cant./Quant.
	Ar./Arru. blindada 22x28x2,5mm Cobre	1
	Ar./Arru. blindada 18x24x2,5mm Cobre	1
	Ar./Arru. 16x22x1,5mm Cobre	1
	Ar./Arru. 15x21x2mm Cobre	4
	Ar./Arru. blindada 10x15x2,5mm Cobre	1



JAE-423 - 7700874592
 Múltiple Admisión y Escape
 Coletor Admissão e Escapamento



1158400 - 7700851213
 Bomba de agua
 Bomba de água



JVS-283-43 - 7700874515
 Junta Tapa Válvula Superior c/arandelas
 Junta Tampa Válvula Superior c/arruelas



1172700 - 7700852434
 Inferior árbol de levas
 Inferior árvore de comando



RT-561Pol
 Juego Ret. Guía de Vál.
 Jogo Retentor da Haste de Válvulas



RT-9607Vit
 Retén Arbol de Levas
 Retentor do Eixo Comando de Válv.
 Lx-R 25,00 x 42,00 x 7,00



2712800 - 7703061078
 Guarnición bomba depresora
 Guarnição bomba depressora pierburg



2712700 - 7701045660
 Guarnición bomba depresora
 Guarnição bomba depressora



2735900 - 7701349382
 Lateral bancada
 Lateral mancal



2740600 - 7700736647
 O'ring 31 x 3mm

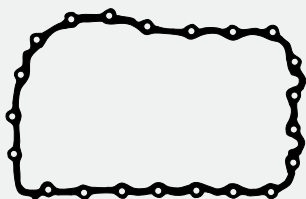

JC-320-43 - 7700108057
 Junta Cártier (Aluminio)
 Junta Carter



2740800
 Guarnición gruesa
 Guarnição grossa
 65 x 4 x 5mm



2701800
 Lateral bancada (Espesor 5,1mm)
 Lateral mancal



RT-9196Vit
 Retén Bancada
 Ret. Traseiro do Virabrequim
 Lx-R 85,00 x 105,00 x 8,00



2707400 - 7701030255
 7701046634
 O'ring 74 x 3mm Bomba vacío
 Bomba vacío (Silicona/Silicone)



1072200 - 7703065088
 7700622283
 Base bomba de combustible
 Base bomba de combustível



RT-8003Pol
 Retén Auxiliar
 Retentor Auxiliar
 Lx-R 30,00 x 40,00 x 7,00



1133400 - 8200105746
 Porta retén distribución
 Porta retentor distribuição



1132800 - 7700724836
 Bomba de vacío
 Bomba de vácuo



2740700 - 7700709470
 Guarnición fina
 Guarnição fina
 65 x 3 x 3,6mm



RT-9606Vit
 Retén Distribución
 Ret. Dianteiro do Virabrequim
 Lx-R 42,00 x 54,00 x 5,80

Productos relacionados no incluidos en el juego. Los mismos pueden ser solicitados por separado.

Produtos relacionados não incluídos no jogo. Podem ser solicitados em separado.

Related products that were not included in the set but can be ordered separately.



BU-039
 Bulones para Culata de Cilindros
 Parafusos de Cabeçote



JT-123
 Juego Turbo
 Jogo Turbo



JSA-325-21
 Salida Escape (Anillo Malla Ac.)
 Saída Escapamento (Anel Malha Aço)

DESCRIPCIÓN / Descrição / Description **DIESEL**

RENAULT: Megane II DCI 2006/10
Laguna II DCI 2005/... - Espace IV 2006/...
Grand Scenic III DCI 2009/... - Koleos

MOTOR / Engine	CM ³	HP	Ø PISTON
M9R 16V	1995	150/160	84.00

Juego Completo de Reparación:

Jogo de Juntas do Motor / Full Set Gasket:

JR-825-11



Semi-Juego de Reparación:

Semi-Jogo de Juntas / Semi-Set Gasket:

SJ-783



Juego de Descarbonización:

Jogo de Juntas Superior / Head Set Gasket:

JD-783-ST



JUNTA CULATA DE CILINDROS	TC-960-11	Ø 84.80mm	1.20mm	↑ ↓
Junta de cabeçote		Ø		↑ ↓
Cylinder Head gasket		Ø		↑ ↓

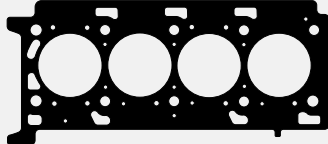

TC-960-11 - 110448588R/8200929931/
8200704323/8200399103
Junta Culata de Cilindros/Junta Cabeçote

JD-783-ST



2071100AQB
Salida Escape
Saída Escapamento



Junta termostato



JVS-366-43 - 7701476555/4420542/1327000Q0A
Junta Tapa Válvula Superior
Junta Tampa Válvula Superior



JAE-294-A - 4420469
Junta Admisión
Junta Admissão



JAE-295-E - 8200363223/4431182
Juego Escape
Jogo Escapamento



2748600
O'ring 53,64 x 2,62mm
Bomba de aceite
Bomba de óleo



2713500
O'ring 64 x 3mm
Bomba de agua
Bomba de água



Juego Retenes Guía Válvulas
Jogo Retentor da Haste de Válvulas

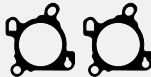

Junta



Junta



Retén Distribución
Retentor Dianteiro do Virabrequim
50 x 81 x 11,5



Junta



Enfriador de aceite
Resfriador de óleo



Porta retén bancada
Flange Traseiro do Virabrequim

Productos relacionados no incluidos en el juego. Los mismos pueden ser solicitados por separado.

Produtos relacionados não incluídos no jogo. Podem ser solicitados em separado.

Related products that were not included in the set but can be ordered separately.

Juego Completo de Reparación:

Jogo de Juntas do Motor / Full Set Gasket:

JR-286-15



Semi-Juego de Reparación:

Semi-Jogo de Juntas / Semi-Set Gasket:

SJ-254



Juego de Descarbonización:

Jogo de Juntas Superior / Head Set Gasket:

JD-140-15



JUNTA CULATA DE CILINDROS	TC-443-15	Ø 89.00mm	1.60mm	±0.05
Junta de cabeçote	TC-443-18	Ø 89.00mm	2.30mm	±0.05
Cylinder Head gasket				

DESCRIPCIÓN / Descrição / Description

RENAULT: R18 LX/TS/TX/TXE/GTX/GTII - R21 TXE Traffic 1989/... - Master 1981/93 - Espace 1984/97
Fuego GTX/GTXII/GTA 1981/86
CITROEN: CX - Athens - **JEEP:** Wrangler 1983/86

MOTOR / Engine	CM ³	HP	Ø PISTON
829-J5R/6R/7R	1995	80/102	88.00
851-J7T	2165	120	88.00

ILLINOIS

RENAULT

JD-140-15

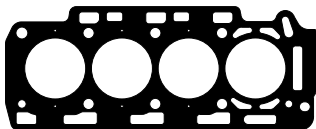

TC-443-15 - 7700720788
Junta Culata de Cilindros
Junta Cabeçote



JAE-320-E - 7700622286
Junta Escape
Junta Escapamento

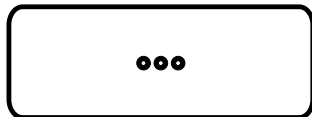

JVS-222-43 - 7700614729
Junta Tapa Válvula Superior c/arandelas
Junta Tampa Válvula Superior c/arruela



1078800 - 7702020130
Tapón tapa válvula
Tampão tampa válvula



JSA-173 - 7702057929
7700679861
Salida Escape
Saída Escapamento



JAE-466-A
Juego Admisión Inyección
Jogo Admissão Injeção



2737400 - 1339920
Anillo termostato
Anel termostato



1059900
Termostato
Termostato



JAE-319-A - 7700622284
Juego Admisión
Jogo Admissão



1072000 - 7701564847
7704000276
Base termostato
Base termostato



2701700 - 7700629742
O'ring distribución
distribuição
39 x 3mm



1137500 - 7702073139
Filtro de aire
Filtro de ar



RT-534Pol
Jgo. Ret. Guía de Vál.
Jogo Retenedor da
Haste de Válvulas



RT-6885Pol
Retén Árbol de Levas
Retenedor do Eixo
Comando de Válvulas
Lx-R 35,00 x 47,00 x 7,00



2711200
O'ring tapón block
mando 47,3 x 2mm
tamp. bloco comando



1048000 - 7700663163
7700655572
Bomba aceite interm. distrib.
Bomba óleo intermedia
distribuição



JC-264-30 - 7702057744
Junta Cártér
Junta Carter

2701800
Lateral bancada
Lateral mancal
(Espesor 5,10mm)

2735900 - 7701349382
Lateral bancada
Lateral mancal



1059800
Bomba de agua
Bomba de água



1047900 - 7700623393
Bomba de agua
Bomba de água



1061800 - 7700623392
Bomba agua a block
Bomba água ao bloco



1047800 - 0608201900
21081107990/7702086169
Base carburador
Base carburador



2743900 - 7701348225
7700850660
Juego arandela camisa (x4)
Jogo arruela camisa



2606600 - 0313030
Arandela blindada
Arruela blindada
18 x 24 x 2,5mm (Cobre)



1136200
Superior bomba aceite
Superior bomba óleo



1072200 - 7703065088
7700622283
Base bomba de combustible
Base bomba de combustível



RT-6884Vit
Retén Bancada
Ret. Traseiro do Virabrequim
Lz-Hel 90 x 110 x 13



RT-8003Pol
Retén Auxiliar
Retenedor Auxiliar
Lx-R 30 x 40 x 7



RT-6883Pol
Retén Distribución
Ret. Diant. do Virabrequim
Lx-R 50 x 68 x 10

Productos relacionados no incluidos en el juego. Los mismos pueden ser solicitados por separado
 Produtos relacionados não incluídos no jogo. Podem ser solicitados em separado / Related products that were not included in the set but can be ordered separately.



BU-047
BU-048
BU-060
Bulones para
Culata de Cilindros
Parafusos de Cabeçote



JB-205
Juego Carburador
Jogo Carburador



JB-194
Juego Carburador
Jogo Carburador



JV-139
Juego Caja Velocidad
Jogo Caixa Velocidade



JB-192
Juego Carburador
Jogo Carburador



JC-264-15
JC-264-23
Junta Cártér
Junta Carter



JB-220
Juego Carburador
Jogo Carburador



JB-224
Juego Carburador
Jogo Carburador



JB-239
Juego Carburador
Jogo Carburador



JB-249
Juego Carburador
Jogo Carburador

DESCRIPCIÓN / Descrição / Description

RENAULT: Megane RT - Scenic - Espace
Laguna RT/RXE

MOTOR / Engine	CM ³	HP	Ø PISTON
F3R 722/796/729	1998	115	82.70

Juego Completo de Reparación:

Jogo de Juntas do Motor / Full Set Gasket:

JR-506-15

R

Semi-Juego de Reparación:

Semi-Jogo de Juntas / Semi-Set Gasket:

SJ-506

R

Juego de Descarbonización:

Jogo de Juntas Superior / Head Set Gasket:

JD-506-15

R

JUNTA CULATA DE CILINDROS	TC-595-15	Ø 83.50mm	1.50mm	±0.05
Junta de cabeçote	TC-595-18	Ø 83.50mm	2.30mm	±0.05
Cylinder Head gasket				



JD-506-15

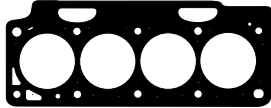

TC-595-15 - 7700859273/7700713860
Junta Culata de Cilindros
Junta Cabeçote



JAE-434 - 7700854539
Múltiple Admisión y Escape
Coletor Admissão e Escapamento



JVS-257-43 - 7700743903
7700719666
Junta Tapa Válvula Superior c/arandelas
Junta Tampa Válvula Superior c/arruelas



JSA-109 - 7700836096
Salida Escape
Saída Escapamento



2606700
Arandela 22 x 28 x 2,5mm
Arruela (Cobre)



JSA-247-21
Salida Escape
Saída Escapamento



1172700 - 7700852434
Termostato
Termostato



2707300 - 7701040923
Guarnición termostato
Guação termostato



2740500 - 7700718380
Anillo termostato
Anel termostato



2729900
Guarnición termostato chica
Guação termostato pequena



2740800
Guarnición gruesa
Guação grossa
65 x 4 x 5mm



RT-561Pol
Juego Ret. Guía de Válvulas
Jogo Retentor da Haste de Válvulas



RT-9607Vit
Retén Arbol de Levas
Retentor do Eixo Comando de Válvulas
Lx-R 25,00 x 42,00 x 7,00



RT-9891Vit
Retén Auxiliar
Retentor Auxiliar
Lx 22,00 x 45,00 x 8,00

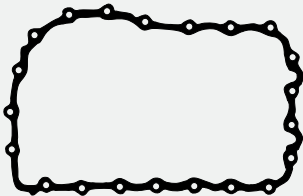

JC-320-43 - 7700108057
Junta Cáster
Junta Carter



1072200 - 7703065088
7700622283
Base bomba de combustible
Bomba de combustível



2701800
Lateral bancada
Lateral mancal
(Espesor 5,10mm)



2735900 - 7701349382
Lateral bancada
Lateral mancal



2740600 - 7700736647
O'ring 31 x 3mm



1158400 - 7700851213
Bomba de agua
Bomba de água



2740700 - 7700709470
Guarnición fina
Guação fina
65 x 3 x 3,6mm



RT-9196Vit
Retén Bancada
Ret. Traseiro do Virabrequim
Lx-R 85,00 x 105,00 x 8,00



RT-9606Vit
Retén Distribución
Retentor Dianteiro do Virabrequim
Lx-R 42,00 x 54,00 x 6,00



RT-8003Pol
Retén Auxiliar
Retentor Auxiliar
Lx-R 30,00 x 40,00 x 7,00

2622300 - Juego Arandelas Metálicas/Jogo Arruelas Metálicas

Gráfico	Descripción/Descrição	Cant./Quant.
○	Ar./Arru. blindada 18x24x2,5mm Cobre	2
○	Ar./Arru. blindada 16x22mm Cobre	2
○	Arand./Arruela 15x21x2mm Cobre	2
○	Arand./Arruela. 12x17x1mm Cobre	2

Productos relacionados no incluidos en el juego. Los mismos pueden ser solicitados por separado.

Produtos relacionados não incluídos no jogo. Podem ser solicitados em separado.

Related products that were not included in the set but can be ordered separately.



BU-036
Bulones para Culata de Cilindros
Parafusos de Cabeçote



BU-203
Bulones para Culata de Cilindros
Parafusos de Cabeçote



JB-242-INY
Juego Carburador
Jogo Carburador



JAE-434-11 - 7700854539
Múltiple Admisión y Escape
Coletor Admissão e Escapamento

Juego Completo de Reparación:

Jogo de Juntas do Motor / Full Set Gasket:

JR-824**Semi-Juego de Reparación:**

Semi-Jogo de Juntas / Semi-Set Gasket:

SJ-824**Juego de Descarbonización:**

Jogo de Juntas Superior / Head Set Gasket:

JD-824

JUNTA CULATA DE CILINDROS	TC-788-15	∅ 83.80mm	1.20mm	↑ ↓
Junta de cabeçote	TC-788-MG	∅ 83.80mm	1.20mm	↑ ↓
Cylinder Head gasket				↑ ↓

DESCRIPCIÓN / Descrição / Description

RENAULT: Duster - Duster Oroch - Captur Sandero 2011/...

MOTOR / Engine	CM ³	HP	∅ PISTON
F4R-400/2/3/4/5/8	1998	135	82.70
Flex/Hi-Flex 16V			

ILLINOIS

RENAULT

JD-824

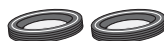
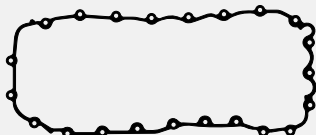
**TC-788** - 7700108254
Junta Culata de Cilindros
Junta Cabeçote**1133000** - 7700104129
Base termostato
Base termostato
2702700
O'ring 28 x 3,5mm**2735700** - 7700109421
Juego guarnición entre múltiple admisión
Jogo guarnição entre múltiplo admissão**JAE-628-E** - 140361015R
Junta Escape
Junta Escapamento**JAE-494-A** - 7700109906
Junta Admisión
Junta Admissão**2735600** - 7700109420
Guarnición entre múltiple admisión
Guarnição entre múltiplo admissão**RT-2959Pol**
Juego Retenes Guía de Válvulas
Jogo Retentor da Haste de Válvulas**RT-2995Pol**
Retén Árbol de Levas .../2009
Retentor do Eixo Comando de Válvulas
28,00 x 47,00 x 5,50**RT-2996Pol**
Retén Árbol de Levas 2009/...
Retentor do Eixo Comando de Válvulas
35,00 x 47,00 x 6,00**JC-410-43** - 8201022396
Junta Cáter
Junta Carter**RT-9643**
Tapón Árbol de Levas
Tampão Eixo Comando de Válvulas
57,00 x 10,50**RT-9644**
Tapón Árbol de Levas
Tampão Eixo Comando de Válvulas
42,50 x 9,00**1133400** - 8200105746
Porta retén distribución
Porta retentor distribuição**1158400** - 7700851213
Bomba de agua
Bomba de água**RT-9656Vit**
Retén Bancada
Retentor Traseiro do Virabrequim
A 275-R 85,00 x 105,00 x 11,00**2606800**
Arandela blindada 10 x 15 x 2,5mm
Arruela blindada(Cobre)**2723500**
Arandela
Arruela
(Goma/Borracha - metal)**RT-9606Vit**
Retén Distribución
Retentor Dianteiro do Virabrequim
Lx-R 42,00 x 54,00 x 5,80

Productos relacionados no incluidos en el juego. Los mismos pueden ser solicitados por separado.

Produtos relacionados não incluídos no jogo. Podem ser solicitados em separado.

Related products that were not included in the set but can be ordered separately.

**2735800**
Juego Admisión
Jogo Admissão

DESCRIPCIÓN / Descrição / Description **DIESEL**

RENAULT: R18 1981/86 - R21 1984/97 - Fuego - Espace
 Trafic 1981/97 - Master 1980/... - R20 - R25 - R30
CHEVROLET: Spacevan - Trafic
JEEP: Jeep Wagoneer TD 1984/95 - Comanche TD 86/88

MOTOR / Engine	CM ³	HP	Ø PISTON
852/J8S	2068	60/86	86.00
121	2068	80	86.00

Juego Completo de Reparación:

Jogo de Juntas do Motor / Full Set Gasket:

Semi-Juego de Reparación:

Semi-Jogo de Juntas / Semi-Set Gasket:

SJ-249

R

Juego de Descarbonización:

Jogo de Juntas Superior / Head Set Gasket:

JD-141-ST

R

JUNTA CULATA DE CILINDROS	TC-563-20 2M	Ø 87.00mm	1.60mm	±0.05	... a 0.96mm
	TC-563-20 1M	Ø 87.00mm	1.70mm	±0.05	de 0.97 a 1.04mm
Junta de cabeçote	TC-563-20 3M	Ø 87.00mm	1.85mm	±0.05	de 1,05mm ...
Cylinder Head gasket	TC-563-20 4M	Ø 87.00mm	2.00mm	±0.05	

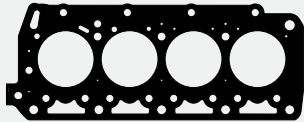

TC-563-20 2M - 7701035217
TC-563-20 1M - 7700711666
TC-563-20 3M - 7701035218
TC-563-20 4M
 Junta Culata de Cilindros
 Junta Cabeçote

JD-141-ST



JAE-353 - 7700663686
 Múltiple Admisión y Escape
 Coletor Admissão e Escapamento



1135900 - 7700735847
 Bomba de agua
 Bomba de água



1136100 - 7700733513
 Cámara agua
 Câmara água



JSA-173 - 7702057929
 7700679861
 Salida Escape
 Saída Escapamento



1136000 - 7700684487
 Codo
 Cotovelo



1135700 - 7700855367
 7700684487
 Cuerpo termostato
 Corpo termostato



JVS-247-15 - 7700662455
 Junta Tapa Válvula Superior
 Junta Tampa Válvula Superior



2701400 - 7703065090
 O'ring termostato
 63 x 1,8mm

2612600 - Juego Arandelas Metálicas/Jogo Arruelas Metálicas

Gráfico	Descripción/Descrição	Cant./Quant.
	Arandela./Arruela 15x21x2mm Cobre	4
	Ar./Arru. c/nervio/nervo 6x14mm Acero	4

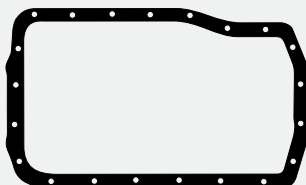

JC-264-30 - 7702057744
 Junta Cártér
 Junta Carter



1136200
 Superior bomba de aceite
 Superior bomba de óleo



1135800 - 7700735848
 Bomba de agua
 Bomba de água



RT-534Pol
 Jgo. Retenes Guía de Vál.
 Jogo Retentor da Haste de Válvulas



RT-6885Pol
 Retén Árbol de Levas
 Ret. do Eixo Comando de Válvulas
 Lx-R 35,00 x 47,00 x 7,00



2743900 - 7701348225
 7700850660
 Juego arandelas camisa
 Jogo arruelas camisa



1048000 - 7700663163
 7700655572
 Bomba aceite int. dist.
 Bomba óleo int. distribuição



1072200 - 7703065088
 7700622283
 Base bomba de combustible
 Base bomba de combustível



RT-6884Vit
 Retén Bancada
 Retentor Traseiro do Virabrequim
 Lz-Hel 90 x 110 x 13



2744800 - 7700666025
 Juego arandelas camisa gruesa
 Jogo arruelas camisa grossa



2607600 - 7703062013
 Arandela 18 x 23 x 1mm
 Arruela (Cobre)



2701600 - 7703065067
 O'ring placa distribución
 placa distribución
 46,2 x 1,8mm



RT-8003Pol
 Retén Auxiliar
 Retentor Auxiliar
 Lx-R 30 x 40 x 7



2707000
 O'ring 15,64 x 2,62mm
 Bomba de aceite
 Bomba de óleo



2607500
 Arandela 16 x 22 x 2,5mm
 Arruela (Cobre)



2701700 - 7700629742
 O'ring distribución
 distribuição 39 x 3mm



RT-6883Pol
 Retén Distribución
 Ret. Dianteiro do Virabrequim
 Lx-R 50 x 68 x 10

Productos relacionados no incluidos en el juego. Los mismos pueden ser solicitados por separado.

Produtos relacionados não incluídos no jogo. Podem ser solicitados em separado.

Related products that were not included in the set but can be ordered separately.



BU-035
 Bulones para Culata de Cilindros
 Parafusos de Cabeçote



JV-146
 Juego Caja Vel.
 Jogo Caixa de Câmbio



JC-264-15 - 7702057744
JC-264-23 - 7702057744
 Junta Cártér
 Junta Carter

Juego Completo de Reparación:

Jogo de Juntas do Motor / Full Set Gasket:

JR-783-11

DESCRIPCIÓN / Descrição / Description

DIESEL**RENAULT: Master III DCI****Semi-Juego de Reparación:**

Semi-Jogo de Juntas / Semi-Set Gasket:

SJ-783**Juego de Descarbonización:**

Jogo de Juntas Superior / Head Set Gasket:

JD-783-ST

JUNTA CULATA DE CILINDROS	TC-959-11	∅ 86.00mm	1.20mm	∅
Junta de cabeçote	TC-959-20	∅ 86.00mm	1.20mm	∅
Cylinder Head gasket				

MOTOR / Engine	CM ³	HP	∅ PISTON
M9T	2298	100/125/150	85.00

ILLINOIS

RENAULT

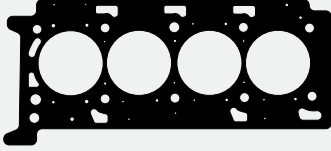
**JD-783-ST**

TC-959-20 - 8200805657
Junta Culata de Cilindros
Junta Cabeçote



2071100AQB
Salida Escape
Saída Escapamento



Junta termostato



JVS-366-43 - 7701476555/4420542/1327000Q0A
Junta Tapa Válvula Superior
Junta Tampa Válvula Superior



JAE-294-A - 4420469
Junta Admisión
Junta Admissão



JAE-295-E - 8200363223/4431182
Juego Escape
Jogo Escapamento



2748600
O'ring 53,64 x 2,62mm
Bomba de aceite
Bomba de óleo



2713500
O'ring 64 x 3mm
Bomba de agua
Bomba de água



Juego Retenes Guía Válvulas
Jogo Retenedor da Haste de Válvulas

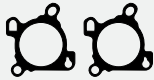

Junta



Junta



Retén Distribución
Retenedor Dianteiro do Virabrequim
50 x 81 x 11,5



Junta



Enfriador de aceite
Resfriador de óleo

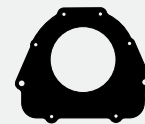

Porta Retén Bancada
Flange Traseiro do Virabrequim

Productos relacionados no incluidos en el juego. Los mismos pueden ser solicitados por separado.

Produtos relacionados não incluídos no jogo. Podem ser solicitados em separado.

Related products that were not included in the set but can be ordered separately.

DESCRIPCIÓN / Descrição / Description **DIESEL**

RENAULT: Master 2001/... - Trafic 2003/...
NISSAN: Primaster - Interstar 2002/...

MOTOR / Engine	CM ³	HP	Ø PISTON
G9U-720/724/730	2463	115	87.00
G9U-750/754	2463	115	87.00
G9U-730	2484	90	87.00
G9U-720/724/750/754	2499	90	87.00

Juego Completo de Reparación:

Jogo de Juntas do Motor / Full Set Gasket:

Semi-Juego de Reparación:

Semi-Jogo de Juntas / Semi-Set Gasket:

SJ-411

R

Juego de Descarbonización:

Jogo de Juntas Superior / Head Set Gasket:

JD-411-ST

R

JUNTA CULATA DE CILINDROS	TC-432 0M	TC-432 1M	TC-432 2M	Ø	Ø	Ø	Ø	Ø	Ø
Junta de cabeçote	TC-432 0M	TC-432 1M	TC-432 2M	90.00mm	90.00mm	90.00mm	1.20mm	1.30mm	1.50mm
Cylinder Head gasket									

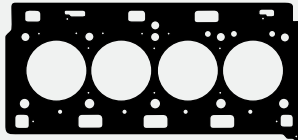

TC-432-20 0M TC-432-MG 0M - 8200406743
TC-432-20 1M TC-432-MG 1M - 8200406743
TC-432-20 2M TC-432-MG 2M - 8200406743
Junta Culata de Cilindros
Junta Cabeçote



JAE-540-E - 8200459643
Junta Escape
Junta Escapamento

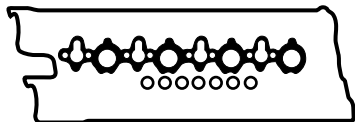

JVS-356-43 - 7701472450
Junta Tapa Válvula Superior c/arrandelas
Junta Tampa Válvula Superior c/arruelas

JD-411-ST



1155100 - 8200008387
Anillo con pestañas
Anel com frisos



2633500
Arandela 10 x 13 x 1,5mm
Arruela (Cobre)



2633300
Arandela 7,2 x 15 x 3mm
Arruela (Cobre)



1113300 - 7701048678
Guarnición
Guarnição

2758800 - Juego Arandelas de Goma/Jogo Arruelas de Borracha

Gráfico	Descripción/Descrição	Cant./Quant.
	O'ring 68x2mm	1
	O'ring 50,52x1,78mm	1
	O'ring 44x3mm	1
	O'ring 37,69x3,53mm	1
	O'ring 32x3,8mm	1
	O'ring 16x2mm	2
	O'ring 6x2mm	2



RT-2987Vit
Juego Ret. Guía de Válvulas
Jogo Retentor da Haste de Válvulas



RT-6858Pol
Retén Arbol de Levas
Ret. do Eixo Comando de Válv.
Lx-R 30,00 x 42,00 x 7,00



JC-378-43 - 7700857225
Junta Cáter
Junta Carter

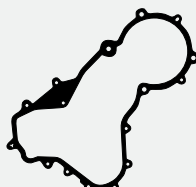

1111500 - 8200265414
Tapa distribución
Tampa distribuição



1113000 - 8200265416
Placa distribución
Placa distribuição



1112900
Bomba de agua
Bomba de água



2700900
O'ring 20,3 x 2,62mm



2707000 - 94632563
O'ring 15,64 x 2,62mm



2748700
O'ring 17,17 x 1,78mm



2607500
Arandela blindada 16 x 22 x 2,5mm
Arruela blindada(Cobre)



RT-9675Vit
Retén Bancada
Retentor Traseiro do Virabrequim
Lx-R 93,00 x 108,00 x 7,00



RT-1183Vit
Retén Distribución
Retentor Dianteiro do Virabrequim
Lx-R 70,00 x 85,00 x 7,00



RT-1185Vit
Retén Distribución
Retentor Dianteiro do Virabrequim
Lx-R 60,00 x 75,00 x 7,00

Productos relacionados no incluidos en el juego. Los mismos pueden ser solicitados por separado.

Produtos relacionados não incluídos no jogo. Podem ser solicitados em separado.

Related products that were not included in the set but can be ordered separately.



BU-240
Bulones para Culata de Cilindros
Parafusos de Cabeçote



JT-155
Juego Turbo
Jogo Turbo

Juego Completo de Reparación:

Jogo de Juntas do Motor / Full Set Gasket:

JR-546-15**Semi-Juego de Reparación:**

Semi-Jogo de Juntas / Semi-Set Gasket:

Juego de Descarbonización:

Jogo de Juntas Superior / Head Set Gasket:

JUNTA CULATA DE CILINDROS	TC-122-15	∅ 82.00mm	1.80mm	↑ ↓	↑ ↓	↑ ↓	↑ ↓
Junta de cabeçote				↑ ↓	↑ ↓	↑ ↓	↑ ↓
Cylinder Head gasket				↑ ↓	↑ ↓	↑ ↓	↑ ↓

DESCRIPCIÓN / Descrição / Description

ROVER: 114 - 214 - 216 - 218 Coupe 1995/...
414 1995/99 - 416 1996/99 - 25 - 45 1999/...

MOTOR / Engine	CM ³	HP	∅ PISTON
14K16	1396	103	75.00
K16	1589	111	80.00
18K16 (DOHC) 16V	1796	120/145	80.00

ILLINOIS

ROVER



TC-122-15 - GUG702576HG
Junta Culata de Cilindros
Junta Cabeçote

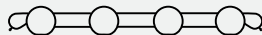

Junta Admisión
Junta Admissão



Varilla media aceite
Vareta media óleo



Junta Admisión
Junta Admissão



Entre colectores admisión
Entre coletores admissão



Junta Escape
Junta Escapamento

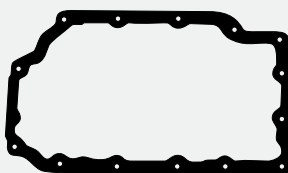

Junta Cárter
Junta Carter



Junta Tapa Válvula
Junta Tampa Válvula



Salida Escape
Saída Escapamento

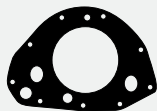

Bomba de aceite
Bomba de óleo



Base filtro aceite a block
Base filtro óleo ao bloco



Salida de agua
Saída de água

Productos relacionados no incluidos en el juego. Los mismos pueden ser solicitados por separado.

Produtos relacionados não incluídos no jogo. Podem ser solicitados em separado.

Related products that were not included in the set but can be ordered separately.



BU-193
Bulones para
Culata de Cilindros
Parafusos de Cabeçote

DESCRIPCIÓN / Descrição / Description **DIESEL**

ROVER: 420 620 220 1994/00 25 45 2000/05
HONDA: Civic 1997/01 Accord 1996/98

MOTOR / Engine	CM ³	HP	Ø PISTON
20T2N	1994	101	84.50
20T2R	1994	86	84.50

Juego Completo de Reparación:

Jogo de Juntas do Motor / Full Set Gasket:

JR-666-11

R

Semi-Juego de Reparación:

Semi-Jogo de Juntas / Semi-Set Gasket:

Juego de Descarbonización:

Jogo de Juntas Superior / Head Set Gasket:

JUNTA CULATA DE CILINDROS	TC-904-11	Ø 85.50mm	1.10mm	↑ ↓
Junta de cabeçote				↑ ↓
Cylinder Head gasket				↑ ↓

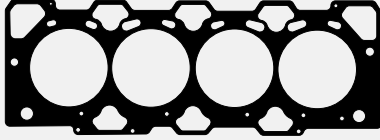

TC-904-11 - LVB100910
 Junta Culata de Cilindros
 Junta Cabeçote



Junta



Salida Escape
 Saída Escapamento

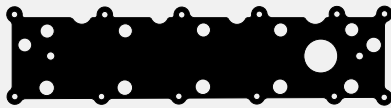

Junta Admisión
 Junta Admissão



Entre colectores admisión
 Entre coletores admissão

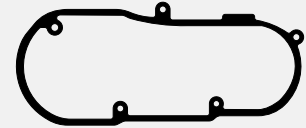

Distribucion
 Distribuição

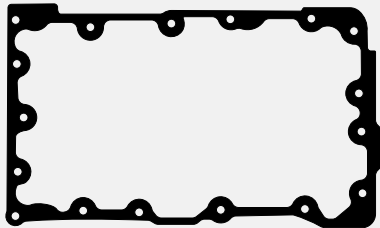

Junta Cáster
 Junta Carter

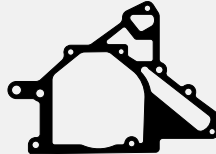

Distribución
 Distribuição



Junta



Junta



Junta



Junta

R

Juego Retenes Guía de Válvulas
 Jogo Retentor da Haste de Válvulas

Productos relacionados no incluidos en el juego. Los mismos pueden ser solicitados por separado.

Produtos relacionados não incluídos no jogo. Podem ser solicitados em separado.

Related products that were not included in the set but can be ordered separately.

Juego Completo de Reparación:

Jogo de Juntas do Motor / Full Set Gasket:

JR-491-07**Semi-Juego de Reparación:**

Semi-Jogo de Juntas / Semi-Set Gasket:

Juego de Descarbonización:

Jogo de Juntas Superior / Head Set Gasket:

JUNTA CULATA DE CILINDROS	TC-839-07	∅ 69.00mm	1.00mm	↑ ↓	↑ ↓	↑ ↓	↑ ↓
Junta de cabeçote				↑ ↓	↑ ↓	↑ ↓	↑ ↓
Cylinder Head gasket				↑ ↓	↑ ↓	↑ ↓	↑ ↓

DESCRIPCIÓN / Descrição / Description

SUZUKI: Alto SS80/F 1980/85
(1140078850/1)

MOTOR / Engine	CM ³	HP	∅ PISTON
F8 - AB51	795	40	68.50

ILLINOIS

SUZUKI

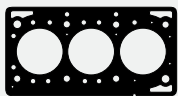

TC-839-07 - 1114178400
Junta Culata de Cilindros
Junta Cabeçote



Junta Admisión
Junta Admissão



Tapa termostato
Tampa termostato



Junta Escape
Junta Escapamento



Junta Admisión
Junta Admissão



Junta



Junta Tapa de Válvula Superior
Junta Tampa de Válvula Superior



Bancada grande
Virabrequim grande



Bancada chica
Virabrequim pequena



Junta Cáster
Junta Carter

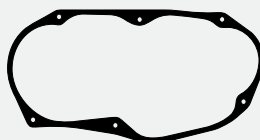

Distribución
Distribuição



Bomba de agua
Bomba de água



Junta



Arandela (Goma)
Arruela (Borracha)
62 x 75 x 3mm



Cuerpo bomba
Corpo bomba



Junta brida
Junta flange



Junta brida
Junta flange



Bomba de nafta
Bomba de gasolina



Junta inspección
Junta inspeção

Productos relacionados no incluidos en el juego. Los mismos pueden ser solicitados por separado.

Produtos relacionados não incluídos no jogo. Podem ser solicitados em separado.

Related products that were not included in the set but can be ordered separately.

DESCRIPCIÓN / Descrição / Description

SUZUKI: Jimny 1977/81 - Carry 1983/...
Cervo - Damas
(1140073811/13/18/19/20/21/22)

MOTOR / Engine	CM ³	HP	Ø PISTON
F8A	797	37	62.00

Juego Completo de Reparación:

Jogo de Juntas do Motor / Full Set Gasket:

JR-664-07

R

Semi-Juego de Reparación:

Semi-Jogo de Juntas / Semi-Set Gasket:

Juego de Descarbonización:

Jogo de Juntas Superior / Head Set Gasket:

JUNTA CULATA DE CILINDROS	TC-494-06	Ø 66.30mm	1.40mm	1.40mm	1.40mm
Junta de cabeçote					
Cylinder Head gasket					

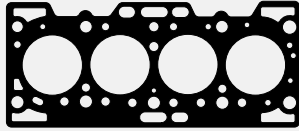

TC-494-06 - 1114173002
Junta Culata de Cilindros
Junta Cabeçote



Salida Escape
Saída Escapamento



Junta



Junta



Junta Escape
Junta Escapamento



Juego Admisión
Jogo Admissão



Junta Lateral
Junta Lateral



Junta



Junta Tapa Válvula Superior
Junta Tampa Válvula Superior



Bancada grande
Virabrequim grande



Bancada chica
Virabrequim pequeno



Junta



Junta Cáster
Junta Carter

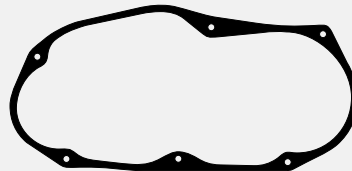

Distribución
Distribuição

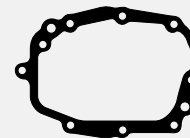

Junta



Junta brida
Junta flange



Junta brida
Junta flange



Bomba de nafta
Bomba de gasolina



Cuerpo bomba
Corpo bomba



Bomba de agua
Bomba de água



Junta inspección
Junta inspeção



Retén Bancada
Retentor Traseiro do
Virabrequim



Retén Árbol de Leva
Retentor do Eixo Comando
de Válvulas



Juego Retenes Guía de Válvulas
Jogo Retentor da Haste de Válvulas

R

Productos relacionados no incluidos en el juego. Los mismos pueden ser solicitados por separado.

Produtos relacionados não incluídos no jogo. Podem ser solicitados em separado.

Related products that were not included in the set but can be ordered separately.

Juego Completo de Reparación:

Jogo de Juntas do Motor / Full Set Gasket:

JR-503-07**Semi-Juego de Reparación:**

Semi-Jogo de Juntas / Semi-Set Gasket:

Juego de Descarbonización:

Jogo de Juntas Superior / Head Set Gasket:

JUNTA CULATA DE CILINDROS	TC-730-15	∅ 67.00mm	1.20mm	↑ ↓
Junta de cabeçote				↑ ↓
Cylinder Head gasket				↑ ↓

DESCRIPCIÓN / Descrição / Description

SUZUKI: Jimny - Super Carry - Samurai
 Jeep 1000 - SJ410/413 1982/99
 (1140080810/4)

MOTOR / Engine	CM ³	HP	∅ PISTON
F10A	970	45	65.50

ILLINOIS

SUZUKI



TC-730-15 - 1114175101/2
 Junta Culata de Cilindros
 Junta Cabeçote



Salida Escape
 Saída Escapamento



Tapa termostato
 Tampa termostato



Junta Escape
 Junta Escapamento



Juego Admisión
 Jogo Admissão



Junta Admisión
 Junta Admissão



Junta Tapa Válvula Superior
 Junta Tampa Válvula Superior



Bancada grande
 Virabrequim grande



Bancada chica
 Virabrequim pequeno



Junta Cárter
 Junta Carter

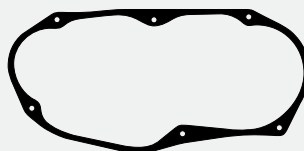

Distribución
 Distribuição



Bomba de agua
 Bomba de água



Junta brida
 Junta flange



Cuerpo bomba
 Corpo bomba



Arandela cóncava
 Arruela cóncava
 (Cobre)



Junta inspección
 Junta inspeção



Junta brida
 Junta flange



Bomba de nafta
 Bomba de gasolina

Productos relacionados no incluidos en el juego. Los mismos pueden ser solicitados por separado.

Produtos relacionados não incluídos no jogo. Podem ser solicitados em separado.

Related products that were not included in the set but can be ordered separately.

DESCRIPCIÓN / Descrição / Description

SUZUKI: Swift Jimny 1998/... - Vitara Wagon (1140052811/1140076871)

MOTOR / Engine	CM ³	HP	Ø PISTON
G13BB	1299	76	74.00

Juego Completo de Reparación:

Jogo de Juntas do Motor / Full Set Gasket:

JR-663-07



Semi-Juego de Reparación:

Semi-Jogo de Juntas / Semi-Set Gasket:

Juego de Descarbonización:

Jogo de Juntas Superior / Head Set Gasket:

JUNTA CULATA DE CILINDROS	TC-688-07	Ø 75.50mm	1.50mm	↑ ↓
Junta de cabeçote				↑ ↓
Cylinder Head gasket				↑ ↓

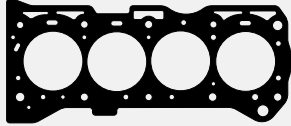

TC-688-07 - 1114170C00/1114186501/02
Junta Culata de Cilindros
Junta Cabeçote



Bomba de agua
Bomba de água



Junta



Junta



Junta Escape
Junta Escapamento



Junta Admisión
Junta Admissão



Junta



Junta Tapa de Válvula
Junta Tampa de Válvula



Distribución
Distribuição



Distribución
Distribuição



Retén Bancada
Retentor Traseiro do Virabrequim



Retén Árbol de Leva
Retentor do Eixo Comando de Válvulas



Juego Retenes Guía de Válvulas
Jogo Retentor da Haste de Válvulas



Productos relacionados no incluidos en el juego. Los mismos pueden ser solicitados por separado.

Produtos relacionados não incluídos no jogo. Podem ser solicitados em separado.

Related products that were not included in the set but can be ordered separately.

Juego Completo de Reparación:

Jogo de Juntas do Motor / Full Set Gasket:

JR-462-15**Semi-Juego de Reparación:**

Semi-Jogo de Juntas / Semi-Set Gasket:

SJ-462**Juego de Descarbonización:**

Jogo de Juntas Superior / Head Set Gasket:

JD-462-15

JUNTA CULATA DE CILINDROS	TC-581-15	∅ 76.00mm	1.60mm	↑ ↓
Junta de cabeçote				↑ ↓
Cylinder Head gasket				↑ ↓

DESCRIPCIÓN / Descrição / Description

SUZUKI: Swift - Sidekick - Samurai - Jimny Cultus 1985/89

MOTOR / Engine	CM ³	HP	∅ PISTON
G13A 8V	1324	60/73	74.00

ILLINOIS

SUZUKI

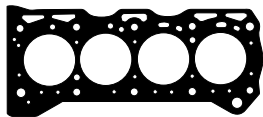
JD-462-15

TC-581-15 - 11141
82600/02/11/86501
Junta Culata de Cilindros
Junta Cabeçote



1088200
Bomba de agua
Bomba de água



1087900
Termostato
Termostato



1088100
Pipeta termostato
Pipeta termostato



JVS-329-30
Junta Tapa Válvula Superior
Junta Tampa Válvula Superior



JAE-509-E
Junta Escape
Junta Escapamento



JAE-508-A
Junta Admisión
Junta Admissão



1077000
Base carburador
Base carburador



JC-355-30
Junta Cárter
Junta Carter



1088300
Porta retén delantero
Porta retentor dianteiro



2702700
O'ring 28 x 3,5mm



1077900
Bomba de nafta
Bomba de gasolina



1088400
Porta retén trasero
Porta retentor traseiro



RT-8627PoI
Retén Distribución
Retentor Dianteiro do Virabrequim
Lx-H 32,00 x 47,00 x 8,00



RT-8628PoI
Retén Arbol de Levas
Ret. do Eixo Comando de Válvulas
Lx-R 32,00 x 47,00 x 6,00



RT-8632PoI
Retén Bancada
Ret. Traseiro do Virabrequim
Lx-H 68,00 x 86,00 x 8,00

Productos relacionados no incluidos en el juego. Los mismos pueden ser solicitados por separado.

Produtos relacionados não incluídos no jogo. Podem ser solicitados em separado.

Related products that were not included in the set but can be ordered separately.

DESCRIPCIÓN / Descrição / Description

SUZUKI: Swift 1989/96 Cultus 1990/01
(1140065850/1140071812)

MOTOR / Engine	CM ³	HP	Ø PISTON
G16B	1590	92	75.00

Juego Completo de Reparación:

Jogo de Juntas do Motor / Full Set Gasket:

JR-662-07

R

Semi-Juego de Reparación:

Semi-Jogo de Juntas / Semi-Set Gasket:

Juego de Descarbonización:

Jogo de Juntas Superior / Head Set Gasket:

JUNTA CULATA DE CILINDROS	TC-734-07	Ø 76.00mm	1.30mm	↑ ↓
Junta de cabeçote		Ø	↑ ↓	↑ ↓
Cylinder Head gasket		Ø	↑ ↓	↑ ↓

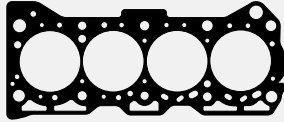

TC-734-07 - 1114171C00
Junta Culata de Cilindros
Junta Cabeçote



Bomba de agua
Bomba de água



Junta



Junta



Junta Escape
Junta Escapamento



Junta Admisión
Junta Admissão



Junta



Junta Tapa de Válvula
Junta Tampa de Válvula



Distribución
Distribuição



Distribución
Distribuição



Retén Bancada
Retenedor Traseiro do
Virabrequim



Retén Árbol de Leva
Retenedor do Eixo Comando
de Válvulas



Juego Retenes Guía de Válvulas
Jogo Retenedor da Haste de Válvulas

R

Productos relacionados no incluidos en el juego. Los mismos pueden ser solicitados por separado.

Produtos relacionados não incluídos no jogo. Podem ser solicitados em separado.

Related products that were not included in the set but can be ordered separately.

Juego Completo de Reparación:

Jogo de Juntas do Motor / Full Set Gasket:

JR-665-11

DESCRIPCIÓN / Descrição / Description

SUZUKI: Grand Vitara 2005/... (1140065862)**Semi-Juego de Reparación:**

Semi-Jogo de Juntas / Semi-Set Gasket:

Juego de Descarbonización:

Jogo de Juntas Superior / Head Set Gasket:

JUNTA CULATA DE CILINDROS	TC-682-11	∅ 85.00mm	0.70mm	↑ ↓
Junta de cabeçote				↑ ↓
Cylinder Head gasket				↑ ↓

MOTOR / Engine	CM ³	HP	∅ PISTON
J20A	1995	128	84.00

ILLINOIS.

SUZUKI

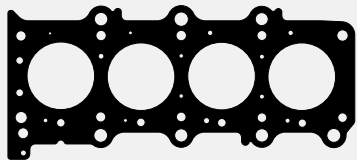

TC-682-11 - 1114121111/1114177E01/02
Junta Culata de Cilindros
Junta Cabeçote



Junta



Junta



Junta Escape
Junta Escapamento



Junta Admisión
Junta Admissão



Bomba combustible
Bomba combustível

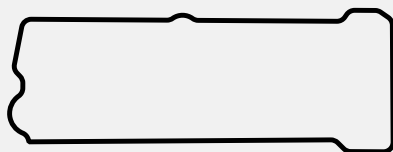

Junta Tapa de Válvula
Junta Tampa de Válvula



Arandela Goma
Arruela Borracha



Juego Retenes Guía de Válvulas
Jogo Retentor da Haste de Válvulas



Retén Bancada
Retentor Traseiro do Virabrequim



Retén Distribución
Retentor Dianteiro do Virabrequim



Retén Árbol de Leva
Retentor do Eixo Comando de Válvulas

Productos relacionados no incluidos en el juego. Los mismos pueden ser solicitados por separado.

Produtos relacionados não incluídos no jogo. Podem ser solicitados em separado.

Related products that were not included in the set but can be ordered separately.

DESCRIPCIÓN / Descrição / Description			
IKA: Utilitario - Gladiator - Torino 1965/74 Jeep T80 1966/73 - Rambler Motor Tornado			
MOTOR / Engine	CM ³	HP	Ø PISTON
OHC 181 - 300/S 380/W 4 Bancadas	2966	140/160	84.94

Juego Completo de Reparación:

Jogo de Juntas do Motor / Full Set Gasket:

JR-218-15



Semi-Juego de Reparación:

Semi-Jogo de Juntas / Semi-Set Gasket:

Juego de Descarbonización:

Jogo de Juntas Superior / Head Set Gasket:

JUNTA CULATA DE CILINDROS	TC-200-15	Ø 87.50mm	1.60mm	↑ ↓
Junta de cabeçote				↑ ↓
Cylinder Head gasket				↑ ↓

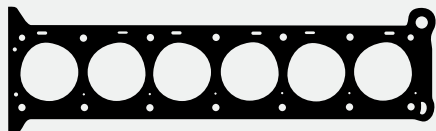

TC-200-15 - 2018010/A/2069497
Junta Culata de Cilindros
Junta Cabeçote



JSA-163 - 2058422
Salida Escape
Saída Escapamento



JSA-112 - 2073972
679023/745608/708130
Salida Escape
Saída Escapamento



JAE-284-A - 2068824
Junta Admisión
Junta Admissão



JAE-236-E - 2069066
Junta Escape
Junta Escapamento



JAE-237-A - 2068039
Junta admisión
Junta admissão



JVS-156-43 - 2019161
Junta Tapa Válvula Superior
Junta Tampa Válvula Superior

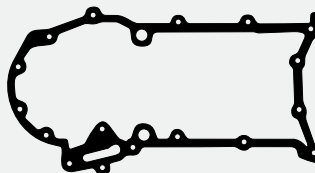

1080600 - 2016971A
Tapa distribución
Tampa distribuição



1025000 - 2016726
Base bomba de nafta
Base bomba de gasolina



1080800 - 2017031C
Tapa inspección
Tampa inspeção

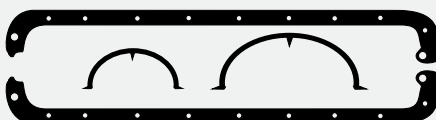

JC-188-30 - 2098986
Junta Cártér
Junta Carter



1080700 - 2017008B
Bomba de agua
Bomba de água



1081300 - 2069022
Base carburador Holley
Base carburador



1081100 - 2018961
Bomba de aceite
Bomba de óleo



1081000 - 2018235C
Bomba de aceite
Bomba de óleo



1080500 - 648852
Base codo agua
Base cotovelo água



1080900 - 2018041C
Base carburador RBS
Base carburador



2717600
Asiento tuerca tapa de válvula
Assento porca tampa de válvula



RT-500Pol
Juego Ret. Guía Válvulas
Jogo Retentor da Haste de Válvulas



RT-6694Pol
Retén Distribución
Ret. Dianteiro do Virabrequim
Lz-R 52,40 x 81,00 x 11,00

Productos relacionados no incluidos en el juego. Los mismos pueden ser solicitados por separado.

Produtos relacionados não incluídos no jogo. Podem ser solicitados em separado.

Related products that were not included in the set but can be ordered separately.



JB-157
Juego Carburador
Jogo Carburador



JB-175
Juego Carburador
Jogo Carburador

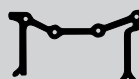

1081400
Media Tapa Distribución
Media Tampa Distribuição



JSA-112-11
Salida Escape
Saída Escapamento

Juego Completo de Reparación:

Jogo de Juntas do Motor / Full Set Gasket:

JR-228-15

DESCRIPCIÓN / Descrição / Description

IKA: Torino Tornado Reforma 1973/74**Semi-Juego de Reparación:**

Semi-Jogo de Juntas / Semi-Set Gasket:

Juego de Descarbonización:

Jogo de Juntas Superior / Head Set Gasket:

JUNTA CULATA DE CILINDROS	TC-200-15	Ø 87.50mm	1.60mm	↑ ↓
Junta de cabeçote				↑ ↓
Cylinder Head gasket				↑ ↓

MOTOR / Engine

CM³

HP

Ø PISTON

OHC 230

3770

180

84.94

4 Bancadas

ILLINOIS

TORINO

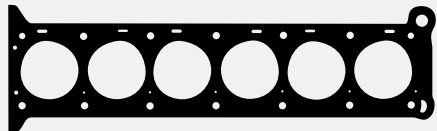

TC-200-15 - 2018010/A/2069497
Junta Culata de Cilindros
Junta Cabeçote



JSA-163 - 2058422
Salida Escape
Saída Escapamento

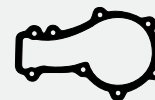

1082200 - 2077537
Bomba de agua
Bomba de água



JAE-284-A - 2068824
Junta Admisión
Junta Admissão



JAE-236-E - 2069066
Junta Escape
Junta Escapamento



1081100 - 2018961
Bomba de aceite
Bomba de óleo



JVS-156-43 - 2019161
Junta Tapa Válvula Superior
Junta Tampa Válvula Superior

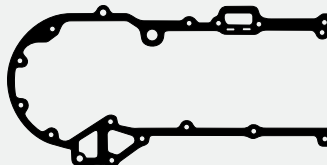

1082300 - 2077747
Tapa distribución
Tampa distribuição



1025000 - 2016726
Base bomba de nafta
Base bomba de gasolina



1080800 - 2017031C
Tapa inspección
Tampa inspeção

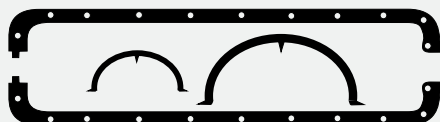

JC-230-30 - 2093746
Junta Cáster
Junta Carter



1082000 - 2069555
Base bomba de aceite
Base bomba de óleo



1023300 - 2068331
Base codo agua
Base cotovelo água



1081300 - 2069022
Base carburador Holley
Base carburador Holley



2717600
Asiento tuerca
tapa de válvula
Assento porca
tampa de válvula



RT-500Pol
Juego Ret. Guía de Vál.
Jogo Retenedor da Haste
de Válvulas



RT-6694Pol
Retén Distribución
Retenedor Dianteiro do Virabrequim
Lz-R 52,40 x 81,00 x 11,00

Productos relacionados no incluidos en el juego. Los mismos pueden ser solicitados por separado.

Produtos relacionados não incluídos no jogo. Podem ser solicitados em separado.

Related products that were not included in the set but can be ordered separately.

DESCRIPCIÓN / Descrição / Description

TORINO: Torino Gran Routier TS 626 1975/81

MOTOR / Engine	CM ³	HP	Ø PISTON
OHC 181 - 230 - 300 380 7 Bancadas	3770		84.94

Juego Completo de Reparación:

Jogo de Juntas do Motor / Full Set Gasket:

JR-257-15



Semi-Juego de Reparación:

Semi-Jogo de Juntas / Semi-Set Gasket:

Juego de Descarbonización:

Jogo de Juntas Superior / Head Set Gasket:

JUNTA CULATA DE CILINDROS	TC-418-15	Ø 87.50mm	1.60mm	1.60mm	1.60mm
Junta de cabeçote					
Cylinder Head gasket					

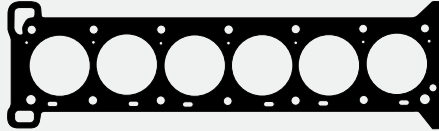

TC-418-15 - 2077745
Junta Culata de Cilindros
Junta Cabeçote



JSA-289
Salida Escape
Saída Escapamento



1082000 - 2069555
Base bomba de aceite
Base bomba de óleo



JAE-284-A - 2068824
Junta Admisión
Junta Admissão



JAE-236-E - 2069066
Junta Escape
Junta Escapamento



1081100 - 2018961
Bomba de aceite
Bomba de óleo



JVS-204-43 - 2214786
Junta Tapa Válvula Superior
Junta Tampa Válvula Superior

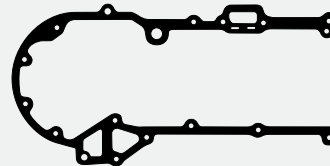

1082300 - 2077747
Tapa distribución
Tampa distribuição



1082200 - 2077537
Bomba de agua
Bomba de água

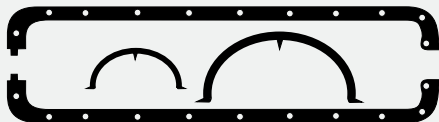

JC-230-30 - 2093746
Junta Cárter
Junta Carter



1023300 - 2068331
Base codo agua
Base cotovelo água



1025000 - 2016726
Base bomba de nafta
Base bomba de gasolina



1081300 - 2069022
Base carburador Holley
Base carburador



2717500
Asiento tuerca tapa de válvula
Assento porca tampa de válvula



1080800 - 2017031C
Tapa inspección
Tampa inspeção



RT-500Pol
Juego Ret. Guía Válvulas
Jogo Retenedor da Haste de Válvulas



RT-6694Pol
Retén Distribución
Ret. Dianteiro do Virabrequim
Lz-R 52,40 x 81,00 x 11,00

Productos relacionados no incluidos en el juego. Los mismos pueden ser solicitados por separado.

Produtos relacionados não incluídos no jogo. Podem ser solicitados em separado.

Related products that were not included in the set but can be ordered separately.



JV-144
Juego Caja Velocidad
Jogo Caixa de Câmbio

Juego Completo de Reparación:

Jogo de Juntas do Motor / Full Set Gasket:

JR-459**Semi-Juego de Reparación:**

Semi-Jogo de Juntas / Semi-Set Gasket:

SJ-459**Juego de Descarbonización:**

Jogo de Juntas Superior / Head Set Gasket:

JD-459

JUNTA CULATA DE CILINDROS	TC-433-15	∅ 80.00mm	1.50mm	↑ ↓
	TC-433-MG	∅ 80.00mm	1.50mm	↑ ↓
Junta de cabeçote				↑ ↓
Cylinder Head gasket				↑ ↓

DESCRIPCIÓN / Descrição / Description

TOYOTA: Corolla 1999/... - Corolla Fielder 03/...
Fielder VVTI 2008/... - Corolla VVTI 2008/...
Avensis 2000/... - RAV4 2000/... - MR2 Spyder
2000/05 - Celica GT 2000/05 - Matrix 2003/08

MOTOR / Engine	CM ³	HP	∅ PISTON
4ZZFE/VVT	1398	97	79.00
3ZZFE	1598	110	79.00
1ZZFE	1794	129/136	79.00

ILLINOIS

TOYOTA

JD-459

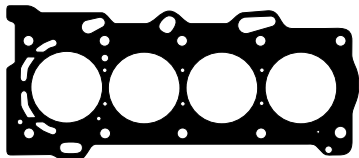

TC-433
Junta Culata de Cilindros
Junta Cabeçote



1115700
Junta



2760000
Válvula termostato
Válvula termostato



JAE-550-A
Junta Admisión
Junta Admissão



JAE-551-A - 1717122030
Junta Admisión
Junta Admissão



JAE-552-E
Junta Escape
Junta Escapamento

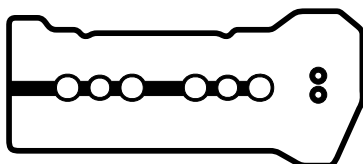

JVS-357-43 - 1121322050
Junta Tapa Válvula Superior c/arruelas
Junta Tampa Válvula Superior c/arruelas



2759800
Bomba de Aceite
Bomba de óleo



RT-8503Pol
Retén Árbol de Leva
Ret. do Eixo Comando de Válvulas
35,00 x 49,00 x 6,00

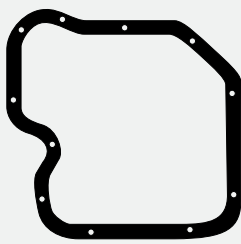

JC-379-30
Junta Cáster
Junta Carter



1115900
Junta



1116300
Junta



1113700
Junta



RT-9640Vit
Retén Distribución
Ret. Dianteiro do Virabrequim
A156-R 38,00 x 50,00 x 8,00



RT-9881Vit
Retén Bancada
Ret. Traseiro do Virabrequim
Lx-R 76,00 x 94,00 x 8,50

Productos relacionados no incluidos en el juego. Los mismos pueden ser solicitados por separado.

Produtos relacionados não incluídos no jogo. Podem ser solicitados em separado.

Related products that were not included in the set but can be ordered separately.



BU-207
Bulones para
Culata de Cilindros
Parafusos de Cabeçote



JSA-327-21
Junta Salida Escape
Junta Saída Escapamento

DESCRIPCIÓN / Descrição / Description

TOYOTA: Etios 2012/... - Etios Cross 2012/...- Yaris

MOTOR / Engine	CM ³	HP	Ø PISTON
2NR-FE 16V	1496	90	72.50

Juego Completo de Reparación:

Jogo de Juntas do Motor / Full Set Gasket:

JR-563



Semi-Juego de Reparación:

Semi-Jogo de Juntas / Semi-Set Gasket:

SJ-563



Juego de Descarbonización:

Jogo de Juntas Superior / Head Set Gasket:

JD-563



JUNTA CULATA DE CILINDROS	TC-799-15	Ø 73.50mm	1.50mm	↑ ↓
Junta de cabeçote	TC-799-MG	Ø 73.50mm	1.50mm	↑ ↓
Cylinder Head gasket		Ø		↑ ↓



JD-563

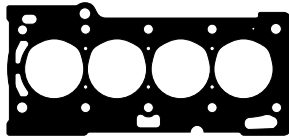

TC-799 - 1111547060
Junta Culata de Cilindros
Junta Cabeçote



JSA-335 - 171730Y010
Salida Escape
Saída Escapamento



2774700
2227147030
Cuerpo mariposa
Corpo borboleta



2775400
O'ring 8 x 3,5mm



JVS-402-43 - 1121347030
Junta Tapa Válvula Superior
Junta Tampa Válvula Superior

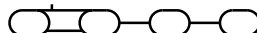

JAE-607-A - 1717747030
Junta Admisión
Junta Admissão



1172200
Bomba de combustible
Bomba de combustível



RT-01783J
Juego Retenes Guía de Válvulas
Jogo Retentor da Haste de Válvulas



2774500
Capuchón goma
Capa borracha
11,5 x 28 x 14mm



2775000
Arandela goma
Arruela borracha
19,5 x 24 x 2,4mm



2774800
Arandela goma
Arruela borracha
32,5 x 38,5 x 5,8mm



2774900
Arandela goma
Arruela borracha
27 x 32,5 x 2,4mm



2775200
O'ring 40 x 4mm



2774600
Arandela goma
Arruela borracha
36 x 50 x 8mm



2775300
O'ring 18 x 1,8mm



2775100
Arandela goma
Arruela borracha
8,5 x 12 x 2,5mm



2774400
162710Y010/47050
Bomba de agua
Bomba de água



RT-2974SiL
Retén Distribución
Retentor Dianteiro do Virabrequim
36,00 x 48,00 x 6,00



RT-2980SiL
Retén Bancada
Retentor Traseiro do Virabrequim
78,00 x 105,00 x 7,50



Productos relacionados no incluidos en el juego. Los mismos pueden ser solicitados por separado.

Produtos relacionados não incluídos no jogo. Podem ser solicitados em separado.

Related products that were not included in the set but can be ordered separately.



JSA-330-21 - 174510M020
Salida Escape (Anillo Malla Acero)
Saída Escapamento
(Anel Malha Aço)

Juego Completo de Reparación:

Jogo de Juntas do Motor / Full Set Gasket:

JR-504-07

DESCRIPCIÓN / Descrição / Description

TOYOTA: Hilux - Dyna 100/150 - Crown - Hiace
Townace - Liteace - Corona - Masterace
Delta Wide - Rocky 1982/.. (0411172010)

MOTOR / Engine	CM ³	HP	Ø PISTON
1Y-J	1626	79/90	86.00
2Y	1812	79/90	86.00
3Y	1998	79/90	86.00

ILLINOIS

TOYOTA

Semi-Juego de Reparación:

Semi-Jogo de Juntas / Semi-Set Gasket:

Juego de Descarbonización:

Jogo de Juntas Superior / Head Set Gasket:

JUNTA CULATA DE CILINDROS	TC-760-07	Ø 88.00mm	1.60mm	1.60mm	1.60mm	1.60mm	1.60mm
Junta de cabeçote							
Cylinder Head gasket							

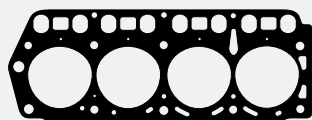
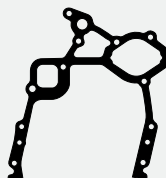
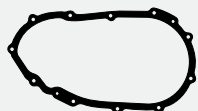
**TC-760-07 - 1111571011**
Junta Culata de Cilindros
Junta CabeçoteBomba de agua
Bomba de águaPorta retén
Flange retentorMúltiple Admisión y Escape
Coletor Admissão e EscapamentoSalida Escape
Saída EscapamentoEntre múltiple admisión
Entre múltiplo admissão**JVS-393-43**
Junta Tapa Válvula Superior c/arruelas
Junta Tampa Válvula Superior c/arruelasPlaca distribución
Placa distribuiçãoArandela 18 x 28 x 2mm
Arruela (Fibra)Brida bomba de aceite
Flange bomba de óleoTapa distribución
Tampa distribuiçãoBase filtro aceite
Base filtro óleoBomba de nafta
Bomba de gasolinaJunta calefactor
Junta aquecedorTermostato
TermostatoArandela 43 x 50 x 5mm
Arruela (Sintético)Juego Retenes Guía de Válvulas
Jogo Retentor da Haste de VálvulasRetén Bancada
Retentor Traseiro do Virabrequim
80,00 x 100,00 x 8,50Retén Distribución
Retentor Dianteiro do Virabrequim
42,00 x 60,00 x 7,00

Productos relacionados no incluidos en el juego. Los mismos pueden ser solicitados por separado.

Produtos relacionados não incluídos no jogo. Podem ser solicitados em separado.

Related products that were not included in the set but can be ordered separately.



DESCRIPCIÓN / Descrição / Description **DIESEL**

TOYOTA: Corona - Avensis TD 1997/00
Corolla 1996/01 (0411164180)

MOTOR / Engine	CM ³	HP	Ø PISTON
2C-T	1975	83	86.00
2C-TE	1975	90	86.00
3C-TE	2184	90	86.00

Juego Completo de Reparación:

Jogo de Juntas do Motor / Full Set Gasket:

JR-660-11

R

Semi-Juego de Reparación:

Semi-Jogo de Juntas / Semi-Set Gasket:

Juego de Descarbonización:

Jogo de Juntas Superior / Head Set Gasket:

JUNTA CULATA DE CILINDROS	TC-460-20	Ø 87.50mm	1.80mm	↕
Junta de cabeçote	TC-460-MG	Ø 87.50mm	1.80mm	↕
Cylinder Head gasket		Ø	↔	↕

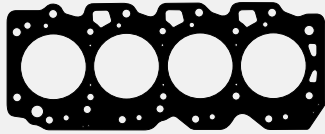

TC-460 - 111156420003
Junta Culata de Cilindros
Junta Cabeçote



Junta



Junta Admisión
Junta Admissão



Junta Escape
Junta Escapamento



Junta

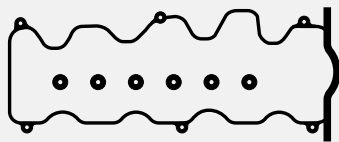

Junta Tapa Válvula Superior
Junta Tampa Válvula Superior



Junta



Bomba agua
Bomba de água



Distribución
Distribuição

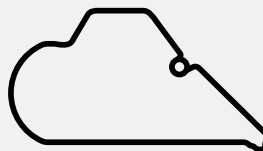

Distribución
Distribuição



Junta



Junta



Junta



Juego Retenes Guía de Válvulas
Jogo Retentor da Haste de Válvulas



Retén Bancada
Retentor Traseiro do
Virabrequim



Retén Distribución
Retentor Dianteiro do Virabrequim



Retén Árbol de Leva
Retentor do Eixo Comando de Válvulas

Productos relacionados no incluidos en el juego. Los mismos pueden ser solicitados por separado.

Produtos relacionados não incluídos no jogo. Podem ser solicitados em separado.

Related products that were not included in the set but can be ordered separately.

Juego Completo de Reparación:

Jogo de Juntas do Motor / Full Set Gasket:

JR-454-07

DESCRIPCIÓN / Descrição / Description

TOYOTA: Celica 1978/82 - Corona 1978/83
Carina 1978/82 - Cressida 1978/83
(0411137031)

MOTOR / Engine	CM ³	HP	Ø PISTON
21R	1972	105	84.00
21R-U	1972	105	84.00

ILLINOIS

TOYOTA

Semi-Juego de Reparación:

Semi-Jogo de Juntas / Semi-Set Gasket:

Juego de Descarbonización:

Jogo de Juntas Superior / Head Set Gasket:

JUNTA CULATA DE CILINDROS	TC-550-07	Ø 86.50mm	1.60mm	↑ ↓ ↑ ↓ ↑ ↓ ↑ ↓
Junta de cabeçote				↑ ↓ ↑ ↓ ↑ ↓ ↑ ↓
Cylinder Head gasket				↑ ↓ ↑ ↓ ↑ ↓ ↑ ↓

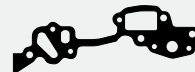
**TC-550-07 - 1111537010/20**
Junta Culata de Cilindros
Junta CabeçotePlaca distribución
Placa distribuiçãoDistribución derecha
Distribuição direitaJunta Admisión
Junta AdmissãoPorta retén
Flange retentorDistribución izquierda
Distribuição esquerdaBase filtro de aceite
Base filtro de óleoBrida agua
Flange água**JVS-397-43**
Junta Tapa Válvula Superior
Junta Tampa Válvula SuperiorSalida Escape
Saída EscapamentoArandela 18 x 28 x 2mm
Arruela (Comprimido)

277060

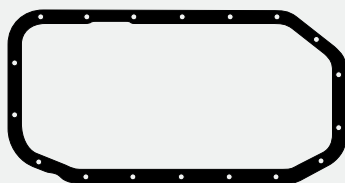

2753200

Junta Cáster
Junta CarterBomba de agua
Bomba de água

2773500

Juego Retenes
Guía de Válvulas
Jogo Retentor da Haste
de VálvulasRetén Bancada
Ret. Traseiro do Virabrequim
80,00 x 100,00 x 12,00Retén Distribución
Ret. Dianteiro do Virabrequim
45,00 x 68,00 x 12,00

Productos relacionados no incluidos en el juego. Los mismos pueden ser solicitados por separado.

Produtos relacionados não incluídos no jogo. Podem ser solicitados em separado.

Related products that were not included in the set but can be ordered separately.

DESCRIPCIÓN / Descrição / Description **DIESEL**

TOYOTA: Dyna 200 1995/... Hilux 1989/93
Liteace Stout Townace Van Van Wagon 1986/90
DAIHATSU: Rocky 1993/01
(0411173040/73046/72010)

MOTOR / Engine	CM ³	HP	Ø PISTON
4Y	2237	93/94	91.00
4Y-EC	2237	94/98/101	91.00

Juego Completo de Reparación:

Jogo de Juntas do Motor / Full Set Gasket:

JR-722-07



Semi-Juego de Reparación:

Semi-Jogo de Juntas / Semi-Set Gasket:

Juego de Descarbonización:

Jogo de Juntas Superior / Head Set Gasket:

JUNTA CULATA DE CILINDROS	TC-853-07	Ø 94.00mm	1.60mm	↑ ↓
Junta de cabeçote		Ø	↑ ↓	↑ ↓
Cylinder Head gasket		Ø	↑ ↓	↑ ↓

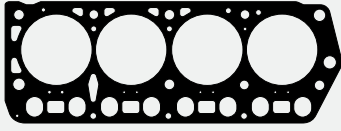

TC-853-07 - 1111573010/30
Junta Culata de Cilindros
Junta Cabeçote



Junta



Junta



Tubo escape
Tubo escapamento



Múltiple Admisión y Escape
Coletor Admissão e Escapamento



Junta



Junta



Bomba de combustible
Bomba de combustível



JVS-393-43
Junta Tapa Válvula Superior
Junta Tampa Válvula Superior



Junta



Bomba de agua
Bomba d'água



Bancada
Mancal



JC-401-30
Junta Carter
Junta Carter

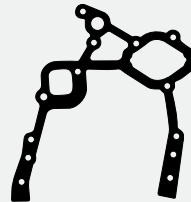

Placa distribución
Placa distribuição

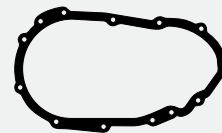

Tapa distribución
Tampa distribuição



Juego Retenes Guía de Válvulas
Jogo Retentor da Haste de Válvulas



Retén Bancada
Retentor Traseiro do Virabrequim
42,00 x 60,00 x 7,00



Retén Distribución
Retentor Dianteiro do Virabrequim
80,00 x 100,00 x 8,50



Productos relacionados no incluidos en el juego. Los mismos pueden ser solicitados por separado.

Produtos relacionados não incluídos no jogo. Podem ser solicitados em separado.

Related products that were not included in the set but can be ordered separately.

Juego Completo de Reparación:

Jogo de Juntas do Motor / Full Set Gasket:

JR-659-11**R**

DESCRIPCIÓN / Descrição / Description

DIESEL**TOYOTA:** Hilux Hi-Ace Dyna 100 1988/90
Corona 1989/96 Mark-II 1989/...
(0411154080)

MOTOR / Engine	CM ³	HP	Ø PISTON
2L	2446	75/83	92.00

ILLINOIS.

TOYOTA

Semi-Juego de Reparación:

Semi-Jogo de Juntas / Semi-Set Gasket:

Juego de Descarbonización:

Jogo de Juntas Superior / Head Set Gasket:

JUNTA CULATA DE CILINDROS	TC-660-20	Ø 93.90mm	1.75mm	↑ ↓
Junta de cabeçote	TC-660-MG	Ø 93.90mm	1.75mm	↑ ↓
Cylinder Head gasket				↑ ↓

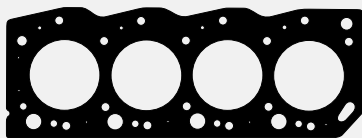

TC-660 - 1111554084
Junta Culata de Cilindros
Junta Cabeçote



Porta retén árbol de levas
Flange Eixo Comando de Válvulas



Bomba de agua
Bomba de água



Junta Admisión
Junta Admissão



JAE-627-E - 1717354030
Junta Escape
Junta Escapamento



Distribución
Distribuição



JVS-392-43
Junta Tapa Válvula Superior
Junta Tampa Válvula Superior



Placa filtro aceite
Placa filtro óleo



Base termostato
Base termostato

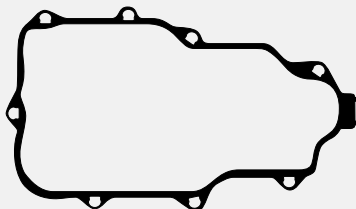

2753500 - 1132854021
Junta Tapa Distribución
Junta Tampa Distribuição

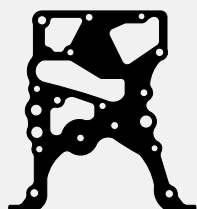

Placa Distribución
Placa Distribuição



2753300
Guarnición
Guarnição



Escape
Escapamento



Tapa termostato
Tampa termostato



Retorno agua
Retorno água



Base filtro aceite
Base filtro óleo



Entrada y salida turbo
Entrada y saída turbo



RT-9196Vit
Retén Bancada
Retentor Traseiro do Virabrequim
85,00 x 105,00 x 8,00



RT-8666Pol
Retén Distribución
Retentor Dianteiro do Virabrequim
42,00 x 60,00 x 7,00



RT-8661Pol
Retén Árbol de Leva
Ret. do Eixo Comando de Válvulas
32,00 x 46,00 x 6,00



Juego Retenes Guía de Válvulas
Jogo Retentor da Haste de Válvulas

R

Productos relacionados no incluidos en el juego. Los mismos pueden ser solicitados por separado.

Produtos relacionados não incluídos no jogo. Podem ser solicitados em separado.

Related products that were not included in the set but can be ordered separately.



BU-517
Bulones para
Culata de Cilindros
Parafusos de Cabeçote

DESCRIPCIÓN / Descrição / Description **DIESEL**

TOYOTA: Hilux D-4D 2001/... Hilux D-4WD 2005/...SW4 D-4WD 2004/... Dyna 150 2001/... Fortuner 2005/... Innova 2001/... Landcruiser 90 2000/... Landcruiser 120 2002/... Landcruiser Prado 120 2006/09

MOTOR / Engine	CM ³	HP	Ø PISTON
1 2KD-FTV DOHC 16V	2494	88/102	92.00
2 1KD-FTV DOHC 16V	2982	109/170	96.00

Juego Completo de Reparación:

Jogo de Juntas do Motor / Full Set Gasket:

Semi-Juego de Reparación:

Semi-Jogo de Juntas / Semi-Set Gasket:

SJ-341

Juego de Descarbonización:

Jogo de Juntas Superior / Head Set Gasket:

JD-341-ST

JUNTA CULATA DE CILINDROS

Junta de cabeçote

Cylinder Head gasket

Ø	Ø	Ø	Ø	Ø	Ø	Ø	Ø
Ø	Ø	Ø	Ø	Ø	Ø	Ø	Ø
Ø	Ø	Ø	Ø	Ø	Ø	Ø	Ø
Ø	Ø	Ø	Ø	Ø	Ø	Ø	Ø

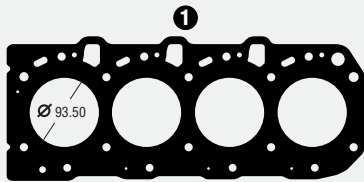

TC-926-20 1M TC-926-MG 1M (0.85mm)
TC-926-20 2M TC-926-MG 2M (0.95mm)
TC-926-20 3M TC-926-MG 3M (1.05mm)
TC-926-20 4M TC-926-MG 4M (1.15mm)
 Junta Culata de Cilindros/Junta Cabeçote

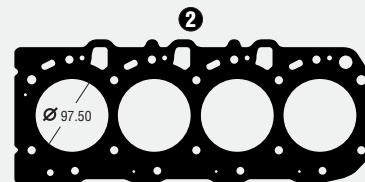

TC-931-20 1M TC-931-MG 1M (0.85mm)
TC-931-20 2M TC-931-MG 2M (0.95mm)
TC-931-20 3M TC-931-MG 3M (1.05mm)
TC-931-20 4M TC-931-MG 4M (1.15mm)
 Junta Culata de Cilindros/Junta Cabeçote



JAE-593 - 1717330020
 Múltiple Admisión y Escape
 Coletor Admissão e Escapamento



JAE-592 - 171770L011
 Múltiple Admisión y Escape
 Coletor Admissão e Escapamento



JVS-382-43 - 1121330020
 Junta Tapa de Válvula
 Junta Tampa de Válvula



1067400
 Caño de circulación
 Tubo circulação



1054700
 Retorno de agua
 Retorno de água



1032000
 Cierre Admisión
 Fechamento Admissão



1055800
 Acople cañería de agua
 Acoplam. tubulação água

JT-129 Jgo. Turbo



JT-129-01
 Junta Turbo



JT-129-02
 Junta Turbo



JT-129-03
 Junta Turbo



JT-129-04
 Junta Turbo

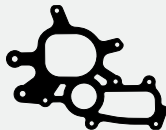

1022600
 Bomba de agua
 Bomba d'água



1048200
 Calefactor
 Aquecedor



1037100
 Cañería de aceite
 Tubulação de água



1014300
 Enfriador y Base filtro de aceite
 Resfriador e base filtro de óleo



1039900
 Unión cierre de aceite
 União fechamento óleo



1067200
 Acople cañería de agua
 Acoplamento tubulação água



2768200
 Base bomba de aceite
 Base bomba de óleo

2770500 - Jgo. Arandelas de Goma/Arruelas de Borracha

Gráfico	Descripción/Descrição	Cant./Quant.
○	O'ring 50x2,3mm	1
○	O'ring 23,5x2,3mm	1
○	O'ring 22x2,3mm	4
○	O'ring 17x1,78mm	1
○	O'ring 17x2,24mm	1
○	O'ring 13,8x2,4mm	1
○	O'ring 10x2,3mm	1
○	O'ring 9x1,78mm	1
○	Arandela 56x63x5,5mm	1
○	Arandela 49,5x56x7,2mm	1

2638400 - Juego Arandelas Metálicas/Jogo Arruelas Metálicas

Gráfico	Descripción/Descrição	Cant./Quant.
○	Aran./Arruela 18x24x1,5mm Alum.	1
○	Aran./Arruela 13x21x1,5mm Alum.	1
○	Aran./Arruela 12x18x1,5mm Alum.	12
○	Aran./Arruela 12x17x1,5mm Alum.	2
○	Aran./Arruela 8x14x1mm Aluminio	12
○	Aran./Arruela 7x16x2mm Cobre	4

Productos relacionados no incluidos en el juego. Los mismos pueden ser solicitados por separado.

Produtos relacionados não incluídos no jogo. Podem ser solicitados em separado.

Related products that were not included in the set but can be ordered separately.



BU-170
 Bulones para Culata de Cilindros
 Parafusos Cabeçote

Juego Completo de Reparación:

Jogo de Juntas do Motor / Full Set Gasket:

JR-542-11**R**

DESCRIPCIÓN / Descrição / Description

DIESEL**TOYOTA:** Hilux - Hiace - Toyo Ace - Dyna 150
1990/... - Landcruiser 1988/... (0411154094)**Semi-Juego de Reparación:**

Semi-Jogo de Juntas / Semi-Set Gasket:

Juego de Descarbonización:

Jogo de Juntas Superior / Head Set Gasket:

JUNTA CULATA DE CILINDROS	TC-487-20	Ø 97.00mm	1.75mm	de 0.88 a 0.97mm
Junta de cabeçote	TC-487-MG	Ø 97.00mm	1.75mm	de 0.88 a 0.97mm
Cylinder Head gasket				

MOTOR / Engine	CM ³	HP	Ø PISTON
3L/3LT	2779	84/123	96.00

ILLINOIS

TOYOTA

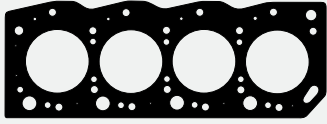

TC-487-20 - 1111554070/71/72/73/74/93
Junta Culata de Cilindros
Junta Cabeçote



Salida Escape
Saída Escapamento



Porta retén árbol de levas
Flange Eixo Comando de Válvulas



Junta Admisión
Junta Admissão



JAE-627-E - 1717354030
Junta Escape
Junta Escapamento



Porta retén bancada trasero
Flange Traseiro do Virabrequim

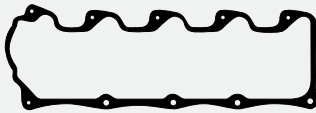

JVS-392-43
Junta Tapa Válvula Superior
Junta Tampa Válvula Superior



Placa filtro aceite
Placa filtro óleo



Base termostato
Base termostato

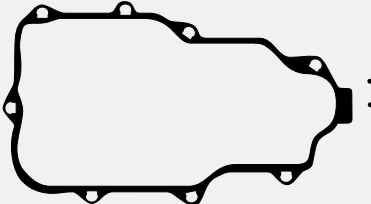

2753500 - 1132854021
Junta Tapa Distribución
Junta Tampa Distribuição



Placa distribución
Placa distribuição



Retorno agua
Retorno água



Guarnición
Guarnição



2753300
Guarnición
Guarnição



Tapa termostato
Tampa termostato



Bomba de agua
Bomba d'água



Escape
Escapamento



Entrada y salida turbo
Entrada y saída turbo



Base filtro aceite
Base filtro óleo



RT-9196Vit
Retén Bancada
Ret. Traseiro do Virabrequim
85,00 x 105,00 x 8,00



RT-8666Pol
Retén Distribución
Ret. Diant. Virabrequim
42,00 x 60,00 x 7,00



RT-8661Pol
Retén Árbol de Leva
Ret. do Eixo Comando de Válv.
32,00 x 46,00 x 6,00

Productos relacionados no incluidos en el juego. Los mismos pueden ser solicitados por separado.

Produtos relacionados não incluídos no jogo. Podem ser solicitados em separado.

Related products that were not included in the set but can be ordered separately.



BU-517
Bulones para Culata de Cilindros
Parafusos de Cabeçote



JT-129
Juego Turbo
Jogo Turbo

DESCRIPCIÓN / Descrição / Description **DIESEL**

TOYOTA: Dyna 1980/95 - Landcruiser 1980/...
Delta - Coster 1980/83 - ToyoAce 1980/88
(0411156030/40)

MOTOR / Engine	CM ³	HP	Ø PISTON
B	2779	80	95.00

--	--	--	--

--	--	--	--

Juego Completo de Reparación:

Jogo de Juntas do Motor / Full Set Gasket:

JR-658-07



Semi-Juego de Reparación:

Semi-Jogo de Juntas / Semi-Set Gasket:

Juego de Descarbonización:

Jogo de Juntas Superior / Head Set Gasket:

JUNTA CULATA DE CILINDROS	TC-551-06	Ø 102.00mm	1.60mm	102.00mm
Junta de cabeçote				
Cylinder Head gasket				

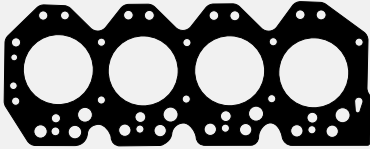

TC-551-06 - 1111556020/60
Junta Culata de Cilindros
Junta Cabeçote



Junta Lateral
Junta Lateral



Junta



Junta Admisión
Junta Admissão



Junta Escape
Junta Escapamento

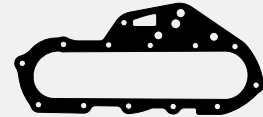

Junta



Junta Tapa Válvula Superior
Junta Tampa Válvula Superior



Junta



Junta



Distribución
Distribuição



Junta Carter
Junta Cárter

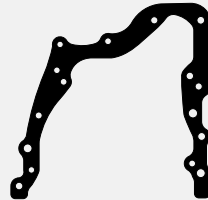

Distribución
Distribuição

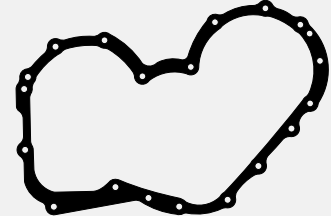

Distribución
Distribuição



Junta



Junta



Junta



Junta



Retén Bancada
Retentor Traseiro do Virabrequim



Retén Distribución
Retentor Dianteiro do Virabrequim



Juego Retenes Guía de Válvulas
Jogo Retentor da Haste de Válvulas

Productos relacionados no incluidos en el juego. Los mismos pueden ser solicitados por separado.

Produtos relacionados não incluídos no jogo. Podem ser solicitados em separado.

Related products that were not included in the set but can be ordered separately.

Juego Completo de Reparación:

Jogo de Juntas do Motor / Full Set Gasket:

Semi-Juego de Reparación:

Semi-Jogo de Juntas / Semi-Set Gasket:

Juego de Descarbonización:

Jogo de Juntas Superior / Head Set Gasket:

SJ-544

JUNTA CULATA DE CILINDROS	TC-877 1M	∅ 97.30mm	∓ 0.75mm	± 0.08 a 0,12mm
Junta de cabeçote	TC-877 2M	∅ 97.30mm	∓ 0.85mm	± 0,13 a 0,22mm
Cylinder Head gasket	TC-877 3M	∅ 97.30mm	∓ 0.95mm	± de 0,23 a 0,33mm

DESCRIPCIÓN / Descrição / Description

DIESEL

TOYOTA: Hilux - Hiace - 4 Runner
Landcruiser TD 1993/2000
(0411167020/23/30)

MOTOR / Engine	CM ³	HP	∅ PISTON
1KZ-T/TE (SOHE)	2982	123/125	96.00

ILLINOIS

TOYOTA

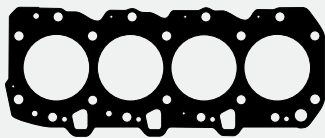

TC-877-20 1M TC-877-MG 1M - 1111567040
TC-877-20 2M TC-877-MG 2M - 1111567050
TC-877-20 3M TC-877-MG 3M - 1111567060
 Junta Culata de Cilindros
 Junta Cabeçote



Cuerpo bomba de aceite y filtro
 Corpo bomba de óleo y filtro



Cuerpo bomba agua a block
 Corpo bomba água ao bloco



Juego Admisión
 Jogo Admissão



Junta Escape
 Jogo Escapamento



Salida Escape
 Saída Escapamento

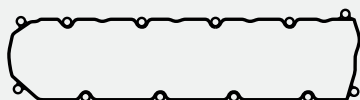

JVS-395-43
 Junta Tapa Válvula Superior
 Junta Tampa Válvula Superior



2772400
 Frente distribución
 Frente distribuição



2772500
 Tapa bomba de agua
 Tampa bomba d'água

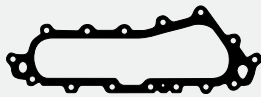

Placa enfriador aceite
 Placa resfriador óleo



2768200
 Guarnición termostato
 Guarnição termostato



Escape turbo
 Escapamento turbo



Bomba alimentación
 Bomba alimentação



Unión cañería aceite
 União tubuiação óleo



Entrada turbo
 Entrada turbo



Unión acople a turbo
 União acoplamento ao turbo



Brinda unión con orejas
 Flange união com orelhas



Acople caño agua
 Acoplamento cano água



Base bomba de aceite
 Base bomba de água



2748000
 O'ring 9 x 2



2767500
 O'ring 22,50 x 2,50



2771700
 O'ring 24,30 x 2,40



2763000
 O'ring 10,77 x 2,62

Productos relacionados no incluidos en el juego. Los mismos pueden ser solicitados por separado.

Produtos relacionados não incluídos no jogo. Podem ser solicitados em separado.

Related products that were not included in the set but can be ordered separately.



BU-518
 Bulones para Culata de Cilindros
 Parafusos de Cabeçote



JSA-302-21
 Salida Escape (Anillo Malla Ac.)
 Saída Escapamento (Anel Malha Aço)

DESCRIPCIÓN / Descrição / Description DIESEL			
TOYOTA: Hilux LN 147/152/167/172 1997/... Hiace LH 162/172/174/1824 Landcruiser - Prado - Dyna 150 1998/... (0411154220)			
MOTOR / Engine	CM ³	HP	Ø PISTON
5L/5L-E	2987	90/97	99.50

Juego Completo de Reparación:

Jogo de Juntas do Motor / Full Set Gasket:

JR-543-11

R

Semi-Juego de Reparación:

Semi-Jogo de Juntas / Semi-Set Gasket:

Juego de Descarbonización:

Jogo de Juntas Superior / Head Set Gasket:

JUNTA CULATA DE CILINDROS	TC-912-11	Ø 100.50mm	1.50mm	↑ ↓
Junta de cabeçote				↑ ↓
Cylinder Head gasket				↑ ↓

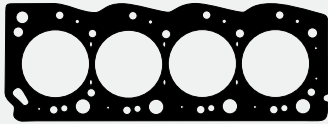

TC-912-11 - 1111554120
Junta Culata de Cilindros
Junta Cabeçote



Salida Escape
Saída Escapamento



Brida cañería
Flange tubulação



Porta retén árbol de levas
Porta retentor
árvore de comando



Múltiple Admisión
Admissão múltipla



JAE-627-E - 1717354030
Junta Escape
Junta Escapamento



Brida cañería
Flange tubulação



Porta retén bancada trasero
Porta retentor mancal traseiro

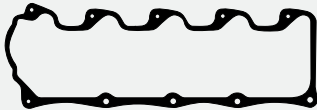

JVS-392-43
Junta Tapa Válvula Superior
Junta Tampa Válvula Superior



Base filtro aceite
Base filtro óleo



Bomba de agua
Bomba d'água



Base termostato

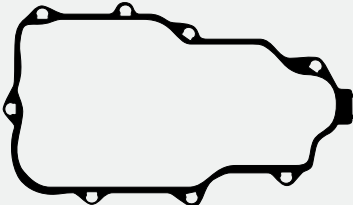

2753500 - 1132854021
Junta Tapa Distribución
Junta Tampa Distribuição



Placa distribución
Placa distribuição



Guarnición termostato
Guarnição termostato



2753200
Guarnición
Guarnição
48 x 55 x 6mm



2752300
23 x 33,5 x 3mm



Entrada y salida turbo
Entrada y saída turbo



Escape
Escapamento



2753300
Guarnición
Guarnição



RT-9196Vit
Retén Bancada
Retentor Traseiro
do Virabrequim
85,00 x 105,00 x 8,00



RT-8666Pol
Retén Distribución
Retentor Dianteiro
do Virabrequim
42,00 x 60,00 x 7,00



RT-8661Pol
Retén Árbol de Leva
Retentor do Eixo
Comando de Válvulas
32,00 x 46,00 x 6,00

R

Productos relacionados no incluidos en el juego. Los mismos pueden ser solicitados por separado.

Produtos relacionados não incluídos no jogo. Podem ser solicitados em separado.

Related products that were not included in the set but can be ordered separately.



JSA-303-21
Salida Escape
(Anillo malla acero)
Saída Escapamento
(Anel Malha Aço)

Juego Completo de Reparación:

Jogo de Juntas do Motor / Full Set Gasket:

JR-768-07**DESCRIPCIÓN / Descrição / Description****TOYOTA: Prado - 4 Runner**

MOTOR / Engine	CM ³	HP	Ø PISTON
5VZ-FE	3378	190	93.50

ILLINOIS

TOYOTA

Juego de Descarbonización:

Jogo de Juntas Superior / Head Set Gasket:

JUNTA CULATA DE CILINDROS	TC-626-07	∅ 95.50mm	1.30mm	∅
Junta de cabeçote	TC-627-07	∅ 95.50mm	1.30mm	∅
Cylinder Head gasket				

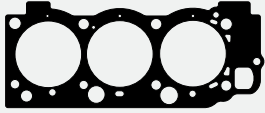

TC-626-07 - 1111562070/1
Junta Culata de Cilindros (Derecha)
Junta Cabeçote (Direita)

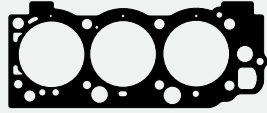

TC-627-07 - 1111562070/1
Junta Culata de Cilindros (Izquierda)
Junta Cabeçote (Esquerda)



Junta

Junta Admisión
Junta AdmissãoJunta Admisión
Junta Admissão

Junta

Junta Escape
Junta Escapamento

JVS-395-43
Junta Tapa Válvula Superior
Junta Tampa Válvula Superior



Junta

Salida Escape
Saída Escapamento

Juego Ret. Guía de Válvulas Admisión
Jogo Retentor da Haste de Válvulas Admissão



Retén Bancada
Retentor Traseiro do Virabrequim
92,00 x 110,00 x 10,00



Retén Distribución
Retentor Dianteiro do Virabrequim
40,00 x 55,00 x 6,00



Juego Ret. Guía de Válvulas Escape
Jogo Retentor da Haste de Válvulas Escapamento



Retén Árbol de Levas
Retentor do Eixo Comando de Válvulas
38,00 x 50,00 x 10,50

Productos relacionados no incluidos en el juego. Los mismos pueden ser solicitados por separado.

Produtos relacionados não incluídos no jogo. Podem ser solicitados em separado.

Related products that were not included in the set but can be ordered separately.

DESCRIPCIÓN / Descrição / Description **DIESEL**

TOYOTA: Dyna - Coaster - Landcruiser 1980/88
(0411158010/40/50)

MOTOR / Engine	CM ³	HP	Ø PISTON
3B	3432	90	102.00

Juego Completo de Reparación:

Jogo de Juntas do Motor / Full Set Gasket:

JR-657-07

R

Semi-Juego de Reparación:

Semi-Jogo de Juntas / Semi-Set Gasket:

Juego de Descarbonización:

Jogo de Juntas Superior / Head Set Gasket:

JUNTA CULATA DE CILINDROS	TC-722-07	Ø 103.00mm	1.60mm	1.60mm	1.60mm
Junta de cabeçote					
Cylinder Head gasket					



TC-722-07 - 1111558081
Junta Culata de Cilindros
Junta Cabeçote



Junta Lateral
Junta Lateral



Junta



Junta Admisión
Junta Admissão



Junta Escape
Junta Escapamento

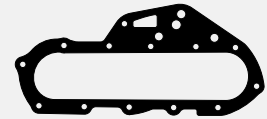

Junta



Junta Tapa Válvula Superior
Junta Tampa Válvula Superior



Junta



Junta



Distribución
Distribuição



Junta Carter
Junta Cárter

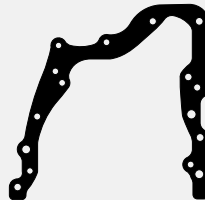

Distribución
Distribuição

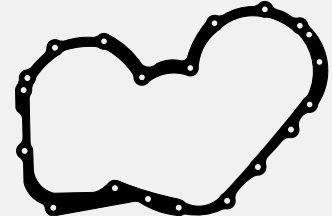

Distribución
Distribuição



Junta



Junta



Junta



Junta



Retén Bancada
Retentor Traseiro do Virabrequim



Retén Distribución
Retentor Dianteiro do Virabrequim



Juego Retenes Guía de Válvulas
Jogo Retentor da Haste de Válvulas

R

Productos relacionados no incluidos en el juego. Los mismos pueden ser solicitados por separado.

Produtos relacionados não incluídos no jogo. Podem ser solicitados em separado.

Related products that were not included in the set but can be ordered separately.

Juego Completo de Reparación:

Jogo de Juntas do Motor / Full Set Gasket:

JR-766-07

DESCRIPCIÓN / Descrição / Description

TOYOTA: Land Cruiser 1975/84**Semi-Juego de Reparación:**

Semi-Jogo de Juntas / Semi-Set Gasket:

Juego de Descarbonización:

Jogo de Juntas Superior / Head Set Gasket:

JUNTA CULATA DE CILINDROS	TC-930-07	∅ 97.00mm	1.60mm	↑ ↓
Junta de cabeçote		∅		↑ ↓
Cylinder Head gasket		∅		↑ ↓

MOTOR / Engine	CM ³	HP	∅ PISTON
2F	4230	135	94.00

ILLINOIS

TOYOTA

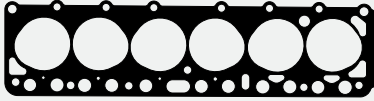

TC-930-07 - 11115-61010/20
Junta Culata de Cilindros
Junta Cabeçote



Junta

Bomba de combustible
Bomba de combustívelMultiple Admisión y Escape
Coletor Admissão e Escapamento

Junta

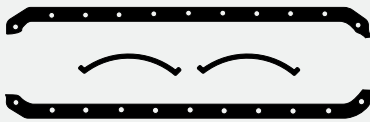

Junta

Junta Tapa de Válvula Superior
Junta Tampa de Válvula SuperiorJunta Tapa Válvula Lateral
Junta Tampa Válvula LateralDistribución
DistribuiçãoJunta Carter
Junta CârtterDistribución
Distribuição

Junta

Bomba de combustible
Bomba de combustívelJuego Ret. Guía de Válvulas
Jogo Retentor da Haste de VálvulasRetén Bancada
Retentor Traseiro do Virabrequim
100,00 x 120,00 x 11,00Retén Distribución
Retentor Dianteiro do Virabrequim
45,00 x 68,00 x 7,00

Productos relacionados no incluidos en el juego. Los mismos pueden ser solicitados por separado.

Produtos relacionados não incluídos no jogo. Podem ser solicitados em separado.

Related products that were not included in the set but can be ordered separately.

DESCRIPCIÓN / Descrição / Description

TOYOTA: Landcruiser - 4 Runner

MOTOR / Engine	CM ³	HP	Ø PISTON
2UZ-FE	4464	270	94.00

Juego Completo de Reparación:

Jogo de Juntas do Motor / Full Set Gasket:

JR-767-07

R

Semi-Juego de Reparación:

Semi-Jogo de Juntas / Semi-Set Gasket:

Juego de Descarbonización:

Jogo de Juntas Superior / Head Set Gasket:

JUNTA CULATA DE CILINDROS	TC-942-07	Ø 95.00mm	1.30mm	↑ ↓
Junta de cabeçote	TC-943-07	Ø 95.00mm	1.30mm	↑ ↓
Cylinder Head gasket				↑ ↓

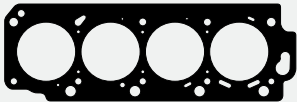

TC-942-07 - 1111650040/70
Junta Culata de Cilindros (Izquierda)
Junta Cabeçote (Esquerda)



TC-932-07 - 1111650050/80
Junta Culata de Cilindros (Derecha)
Junta Cabeçote (Direita)



Junta



Juego Admisión
Jogo Admissão



Junta Escape
Junta Escapamento

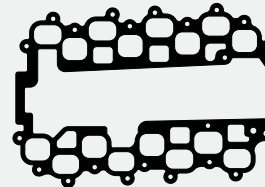

Junta Admisión
Junta Admissão



Junta



Junta Tapa Válvula Superior
Junta Tampa Válvula Superior



Bomba de agua
Bomba de água



Junta



Juego Ret. Guía de Válvulas Escape
Jogo Retentor da Haste de Válvulas Escapamento



Juego Ret. Guía de Válvulas Admisión
Jogo Retentor da Haste de Válvulas Admissão



Retén Bancada
Retentor Traseiro do Virabrequim
95,00 x 113,00 x 8,50



Retén Distribución
Retentor Dianteiro do Virabrequim
42,00 x 60,00 x 7,00

R

Productos relacionados no incluidos en el juego. Los mismos pueden ser solicitados por separado.

Produtos relacionados não incluídos no jogo. Podem ser solicitados em separado.

Related products that were not included in the set but can be ordered separately.

Juego Completo de Reparación:

Jogo de Juntas do Motor / Full Set Gasket:

JR-221-15**R****Semi-Juego de Reparación:**

Semi-Jogo de Juntas / Semi-Set Gasket:

Juego de Descarbonización:

Jogo de Juntas Superior / Head Set Gasket:

JD-105-15**R**

JUNTA CULATA DE CILINDROS	TC-392-15	∅ 89.00mm	1.60mm	↑ ↓
Junta de cabeçote				↑ ↓
Cylinder Head gasket				↑ ↓

DESCRIPCIÓN / Descrição / Description

DODGE: Valiant I/II/III/IV - D100 - D2800
GT Coronado - RT 1964/79 - Polara
GTX Pick Up 1962/80 (2488777)

MOTOR / Engine	CM ³	HP	∅ PISTON
170	2788	130	86.36
225	3687	130	86.36

ILLINOIS

VALIANT

**JD-105-15**

TC-392-15 - 1947578
Junta Culata de Cilindros
Junta Cabeçote



JAE-286 - 2206120
Múltiple Admisión y Escape
Coletor Admissão e Escapamento



JVS-193-30 - 2121244/2406625
Junta Tapa Válvula Superior
Junta Tampa Válvula Superior



JSA-112 - 2073972
679023/745608/708130
Salida Escape
Saída Escapamento



1082800 - 1947671
Salida agua
Saída água



RT-532Pol
Juego Ret. Guía Válvulas
Jogo Retentor da Haste de Válvulas



1082400 - 1400185
Bomba de nafta
Bomba de gasolina



1083400 - 2268870
Base filtro aceite
Base filtro óleo

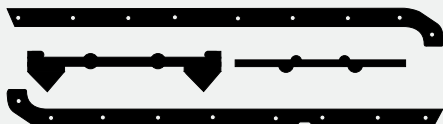

JC-232-30 - 2240697
Junta Cártter
Junta Carter



1083000 - 2121404
Bomba de aceite block
Bomba de óleo ao bloco



1082500 - 1947521
Bomba de agua
Bomba de água

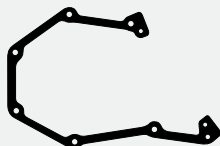

1082700 - 1947554
Tapa distribución
Tampa distribuição



1083200 - 2268264
Entre caño múltiple
Entre tubo múltiplo



1082600 - 1947523
Bomba de agua
Bomba de água



RT-6699
Retén Distribución
Ret. Dianteiro do Virabrequim
A 080-R 56,93 X 0 X 14,00

Productos relacionados no incluidos en el juego. Los mismos pueden ser solicitados por separado.

Produtos relacionados não incluídos no jogo. Podem ser solicitados em separado.

Related products that were not included in the set but can be ordered separately.



JB-162
Juego Carburador
Jogo Carburador



JSA-112-11
Salida Escape
Saída Escapamento

DESCRIPCIÓN / Descrição / Description

VOLKSWAGEN: Gol 1000 - Saveiro
Polo 1995/... - Parati 1997/...
SEAT: Ibiza - Cordoba 1996/...

MOTOR / Engine	CM ³	HP	Ø PISTON
AER/ALL/AT (SOHC) 8V	999	50/69	67.10

Juego Completo de Reparación:

Jogo de Juntas do Motor / Full Set Gasket:

JR-361**R****Semi-Juego de Reparación:**

Semi-Jogo de Juntas / Semi-Set Gasket:

SJ-361**R****Juego de Descarbonización:**

Jogo de Juntas Superior / Head Set Gasket:

JD-361**R**

JUNTA CULATA DE CILINDROS	TC-720-15	Ø 70.00mm	1.50mm	
Junta de cabeçote	TC-720-MG	Ø 70.00mm	1.30mm	
Cylinder Head gasket	TC-720-18	Ø 70.00mm	2.30mm	

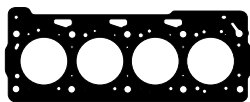
**JD-361**

TC-720 - 036103383M
Junta Culata de Cilindros
Junta Cabeçote



JAE-474-A
Juego Admisión
Jogo Admissão



JVS-301-43 - 030103483K
Junta Tapa Válvula Superior
Junta Tampa Válvula Superior



JSA-256 - 377253115/C
Salida Escape
Saída Escapamento



JAE-415-E - 032/253039/E
Junta Escape
Junta Escapamento



RT-564Pol
Juego Retenes Guía de Válvulas
Jogo Retentor da Haste de Válvulas



RT-8422Pol
Retén Distrib. y Árbol de Levas
Retentor Dianteiro do Virabrequim e do Eixo Comando de Válvulas
Lx-Bidi 32,00 x 47,00 x 10,00



2712500
Estribo goma
Separador de óleo



2712100
Arandela (Goma)
Arruela (Borracha)
38 x 45 x 6mm



2712300
O'ring 36,5 x 3,53mm



JC-344-30 - 036036011
Junta Cártér
Junta Carter



1136400 - 032103161/K
Distribución
Distribuição



1136600 - 030103161/K
Distribución
Distribuição



1113500 - 026103181B
Bancada trasera
Retentor Traseiro do Virabrequim



2711900
O'ring 60 x 4mm



2708500
O'ring 48 x 5mm



2711800
O'ring 67,5 x 4mm



1136700 - 036/115111
Bomba de aceite
Bomba de óleo



2712200
O'ring 22,2 x 4mm



2606900 - N/013849/2
Arandela
Arruela (Cobre)
14 x 20 x 1,5mm



2712400
O'ring 7,8 x 2,5mm



RT-6863Vit
Retén Bancada
Ret. Traseiro do Virabrequim
Lx-R 85,00 x 105,00 x 12,00

Productos relacionados no incluidos en el juego. Los mismos pueden ser solicitados por separado.

Produtos relacionados não incluídos no jogo. Podem ser solicitados em separado.

Related products that were not included in the set but can be ordered separately.



BU-045
Bulones p/Culata de Cilindros
Parafusos Cabeçote



BU-530
Bulones p/Culata de Cilindros
Parafusos Cabeçote



RT-9828Vit
Porta Retén Bancada
Flange Traseiro do Virabrequim
A 311-R 85,00



JSA-317-21
Junta Salida Escape
(Anillo Malla Acero)
Junta Saída Escap.
(Anel Malha Aço)

Juego Completo de Reparación:

Jogo de Juntas do Motor / Full Set Gasket:

JR-536**R****Semi-Juego de Reparación:**

Semi-Jogo de Juntas / Semi-Set Gasket:

SJ-536**R****Juego de Descarbonización:**

Jogo de Juntas Superior / Head Set Gasket:

JD-536**R**

JUNTA CULATA DE CILINDROS	TC-720-15	∅ 70.00mm	1.50mm	↑ ↓
Junta de cabeçote	TC-720-MG	∅ 70.00mm	1.30mm	↑ ↓
Cylinder Head gasket	TC-720-18	∅ 70.00mm	2.30mm	↑ ↓

DESCRIPCIÓN / Descrição / Description

VOLKSWAGEN: Gol 1000 - Saveiro 1998/...
Parati 16V

MOTOR / Engine	CM ³	HP	∅ PISTON
AT - ASW - AZP (DOHC)16V	999	69/76	67.10

ILLINOIS

VOLKSWAGEN

JD-536**TC-720** - 036103383M
Junta Culata de Cilindros
Junta Cabeçote**JVS-340-43** - 0361034836
Junta Tapa de Válvula c/cabezal
Junta Tampa Válvula c/cabeça**JAE-532-A**
Juego Admisión
Jogo Admissão**JAE-533-E** - 036253039/C
Junta Escape
Junta Escapamento**RT-581PoI**
Juego Retenes Guía de Válvulas
Jogo Retentor da Haste de Válvulas**RT-8422PoI**
Retén Árbol de Levas
Retentor do Eixo Comando
de Válvulas
Lx-Bidi 32,00 x 47,00 x 10,00**JSA-296** - 377253115/C
Salida Escape
Saída Escapamento**JC-344-30** - 036036011
Junta Cárter
Junta Carter**2751900 - Juego Arandelas de Goma/Jogo Arruelas de Borracha**

Gráfico	Descripción/Descrição	Cant./Quant.
	O' ring 60x4mm	1
	O' ring 48x5mm	2
	O' ring 36,5x3,53mm	1
	O' ring 22,2x4mm	2
	O' ring 7,8x2,5mm	1

2606900 - N/013849/2
Arandela
Arruela (Cobre)
14 x 20 x 1,5mm
2712500
Estribo goma
Separador de óleo
1136700 - 036115111
Bomba de aceite
Bomba de óleo
2712100
Arandela (Goma)
Arruela (Borracha)
38 x 45 x 6mm
1113500 - 026103181B
Bancada trasera
Virabrequim traseira
1136400 - 032103161/K
Distribución
Distribuição**RT-6863Vit**
Retén Bancada
Retentor Traseiro do Virabrequim
Lx-R 85,00 x 105,00 x 12**RT-8422PoI**
Retén Distribución
Retentor Dianteiro do Virabrequim
Lx-Bidi 32,00 x 47,00 x 10,00

Productos relacionados no incluidos en el juego. Los mismos pueden ser solicitados por separado.

Produtos relacionados não incluídos no jogo. Podem ser solicitados em separado.

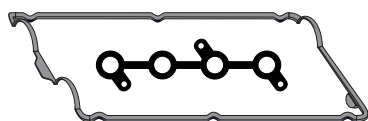
Related products that were not included in the set but can be ordered separately.

**BU-045**
Bulones p/Culata de Cilindros
Parafusos Cabeçote**BU-530**
Bulones p/Culata de Cilindros
Parafusos Cabeçote**RT-9828Vit**
Porta Retén Bancada
Flange Traseiro do Virabrequim
A 311-R 85,00**JSA-317-21**
Junta Salida Escape
(Anillo Malla Acero)
Junta Saída Escap.
(Anel Malha Aço)

DESCRIPCIÓN / Descrição / Description

VOLKSWAGEN: Gol Power 2002/...
BRASIL

MOTOR / Engine	CM ³	HP	Ø PISTON
AT (DOHC)16V	999	76	67.10

Juego Completo de Reparación:

Jogo de Juntas do Motor / Full Set Gasket:

JR-547**R****Semi-Juego de Reparación:**

Semi-Jogo de Juntas / Semi-Set Gasket:

SJ-547**R****Juego de Descarbonización:**

Jogo de Juntas Superior / Head Set Gasket:

JD-547**R**

JUNTA CULATA DE CILINDROS	TC-720-15	Ø 70.00mm	1.50mm
	TC-720-MG	Ø 70.00mm	1.30mm
	TC-720-18	Ø 70.00mm	2.30mm
Junta de cabeçote			
Cylinder Head gasket			



JD-547

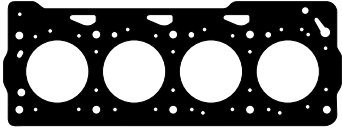

TC-720 - 036103383M
Junta Culata de Cilindros
Junta Cabeçote



JAE-532-A
Juego Admisión
Jogo Admissão



JSA-256 - 377253115/C
Salida Escape
Saída Escapamento



JVS-390-28
Junta Tapa de Válvula
Junta Tampa de Válvula



JAE-533-E - 036253039/C
Junta Escape
Junta Escapamento



RT-581Pol
Juego Retenes Guía Válvulas
Jogo Retentor da Haste de Válvulas

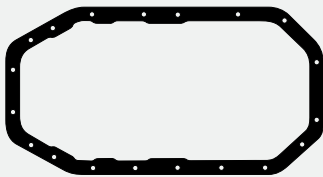

JC-344-30 - 036036011
Junta Cáster
Junta Carter



1136400 - 032103161/K
Distribución
Distribuição



RT-2973Pol
Retén Árbol de Leva
Retentor do Eixo Comando de Válvulas
27,00 x 42,00 x 7,00



1136700 - 036/115111
Bomba de aceite
Bomba de óleo



2712500
Estribo goma
Separador de óleo



1113500 - 026103181B
Bancada trasera
Mancal traseira



2610600
Arandela
Arruela (Aluminio)
14 x 20 x 1,5mm



RT-9912Vit
Retén Distribución
Ret. Dianteiro do Virabrequim
Lx-R 32,00 x 42,00 x 8,00

2755000 - Juego Arand. Goma/Jogo Arruelas Borracha

Gráfico	Descripción/Descrição	Cant./Quant.
	O' ring 60x4mm	1
	O' ring 46,8x4,3mm	2
	O' ring 43x3,4mm	1
	Arandela/Arruela 38X45X6mm	1
	O' ring 36,5x3,53mm	1
	O' ring 22,2x4mm	2
	O' ring 7,8x2,5mm	1

Productos relacionados no incluidos en el juego. Los mismos pueden ser solicitados por separado.

Produtos relacionados não incluídos no jogo. Podem ser solicitados em separado.

Related products that were not included in the set but can be ordered separately.



BU-530
Bulones p/Culata de Cilindros
Parafusos Cabeçote



RT-9828Vit
Porta Retén Bancada
Flange Traseiro do Virabrequim
A 311-R 85,00



RT-3007
Porta Retén Bancada
Flange Traseiro do Virabrequim
(Sensor Cuad./Quadrado)



RT-3006
Porta Retén Bancada
Flange Traseiro do Virabrequim
(Sensor Redondo)



JSA-316
Salida Escape
Saída Escapamento



JSA-317-21
Junta Salida Escape
(Anillo Malla Acero)
Junta Saída Escap.
(Anel Malha Aço)

Juego Completo de Reparación:

Jogo de Juntas do Motor / Full Set Gasket:

JR-548**R****Semi-Juego de Reparación:**

Semi-Jogo de Juntas / Semi-Set Gasket:

SJ-548**R****Juego de Descarbonización:**

Jogo de Juntas Superior / Head Set Gasket:

JD-548**R**

JUNTA CULATA DE CILINDROS	TC-720-15	∅ 70.00mm	1.50mm	↑ ↓
Junta de cabeçote	TC-720-MG	∅ 70.00mm	1.30mm	↑ ↓
Cylinder Head gasket	TC-720-18	∅ 70.00mm	2.30mm	↑ ↓

DESCRIPCIÓN / Descrição / Description

VOLKSWAGEN: Gol Power 2002/...
BRASIL

MOTOR / Engine	CM ³	HP	∅ PISTON
AT (SOHC)8V	999	50/69	67.10

ILLINOIS

VOLKSWAGEN

JD-548**TC-720 - 036103383M**
Junta Culata de Cilindros
Junta Cabeçote**JAE-474-A**
Juego Admisión
Jogo Admissão**JSA-256 - 377253115/C**
Salida Escape
Saída Escapamento**JVS-390-28**
Junta Tapa de Válvula
Junta Tampa de Válvula**JAE-507-E - 030253039K**
Junta Escape
Junta Escapamento**RT-564Pol**
Juego Retenes Guía Válvulas
Jogo Retedor da Haste de Válvulas**JC-344-30 - 036036011**
Junta Carter
Junta Carter**2755000 - Jgo. Arandelas de Goma/Arruelas Borracha**

Gráfico	Descripción/Descrição	Cant./Quant.
	O' ring 60x4mm	1
	O' ring 46,8x4,3mm	2
	O' ring 43x3,4mm	1
	Arandela/Arruela 38X45X6mm	1
	O' ring 36,5x3,53mm	1
	O' ring 22,2x4mm	2
	O' ring 7,8x2,5mm	1

**1136400 - 032103161/K**
Distribución
Distribuição
2610600
Arandela (Aluminio)
14 x 20 x 1,5mm
1136700 - 036/115111
Bomba de aceite
Bomba de óleo**1113500 - 026103181B**
Bancada trasera
Virabrequim traseira
2712500
Estribo goma
Separador de óleo
2709100
O'ring 20 x 4mm**RT-9912Vit**
Retén Distribución
Retedor Dianteiro do Virabrequim
Lx-R 32,00 x 42,00 x8,00

Productos relacionados no incluidos en el juego. Los mismos pueden ser solicitados por separado.

Produtos relacionados não incluídos no jogo. Podem ser solicitados em separado.

Related products that were not included in the set but can be ordered separately.

**BU-045**
Bulones p/Culata de Cilindros
Parafusos Cabeçote**RT-9828Vit**
Porta Retén Bancada
Flange Traseiro do Virabrequim
A 311-R 85,00**RT-3007**
Porta Retén Bancada
Flange Traseiro do Virabrequim
(Sensor Cuad./Quadrado)**RT-3006**
Porta Retén Bancada
Flange Traseiro do Virabrequim
(Sensor Redondo)**JSA-316**
Salida Escape
Saída Escapamento**JSA-317-21**
Junta Salida Escape
(Anillo Malla Acero)
Junta Saída Escap.
(Anel Malha Aço)

DESCRIPCIÓN / Descrição / Description

VOLKSWAGEN: Fox 2003/...
BRASILMOTOR / Engine CM³ HP Ø PISTON

AQZ - BJE 8V 999 71/72 67.10

Juego Completo de Reparación:

Jogo de Juntas do Motor / Full Set Gasket:

JR-549

R

Semi-Juego de Reparación:

Semi-Jogo de Juntas / Semi-Set Gasket:

SJ-549

R

Juego de Descarbonización:

Jogo de Juntas Superior / Head Set Gasket:

JD-549

R

JUNTA CULATA DE
CILINDROS

Junta de cabeçote

Cylinder Head gasket

TC-720-15	∅ 70.00mm	1.50mm	±0.05
TC-720-MG	∅ 70.00mm	1.30mm	±0.05
TC-720-18	∅ 70.00mm	2.30mm	±0.05
	∅		±0.05

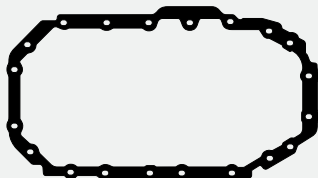
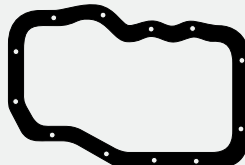

JD-549

TC-720 - 036103383M
Junta Culata de Cilindros
Junta Cabeçote2712000 - 030121005
Termostato
O'ring 46,8 x 4mmJAE-507-E - 030253039K
Junta Escape
Junta EscapamentoJAE-474-A
Juego Admisión
Jogo AdmissãoJVS-390-28
Junta Tapa de Válvula
Junta Tampa de VálvulaJSA-256 - 377253115/C
Salida Escape
Saída EscapamentoJC-398-25 - 032103601AA
Junta Cártér
Junta CarterJC-354-26 - 032103601AA
Junta Sobre Cártér
Junta Sobre Carter1136400 - 032103161/K
Distribución
Distribuição1136700 - 036/115111
Bomba de aceite
Bomba de óleo2610600
Arandela 14 x 20 x 1,5mm
Arruela (Aluminio)2712500
Estribo goma
Separador de óleoRT-9912Vit
Retén Bomba Aceite
Retentor Bomba de Óleo
Lx-R 32,00 x 42,00 x 8,00

2755100 - Juego Aran. Goma/Jogo Arruelas Borracha

Gráfico	Descripción/Descrição	Cant./Quant.
	Arandela/Arruela 64x69x5mm	1
	O'ring 46,8x4,3mm	2
	O'ring 36,5x3,53mm	1
	O'ring 32x3,8mm	2
	O'ring 28x3,5mm	1
	O'ring 7,52x3,53mm	8

RT-9912Vit
Retén Árbol de Levas
Ret. do Eixo Comando de Válvulas
Lx-R 32,00 x 42,00 x 8,00RT-594Pol
Juego Ret. Guía Válvulas
Jogo Retentor da Haste
de Válvulas

2755200 - Juego Arand. Goma/Jogo Arruelas Borracha

Gráfico	Descripción/Descrição	Cant./Quant.
	O'ring 66,27x3,53mm	1
	O'ring 60x4mm	2
	O'ring 37x4mm	1
	O'ring 30x3,5mm	2
	O'ring 20x4mm	2
	Asiento Inyector/Assento Injetor	4

Productos relacionados no incluidos en el juego. Los mismos pueden ser solicitados por separado.

Produtos relacionados não incluídos no jogo. Podem ser solicitados em separado.

Related products that were not included in the set but can be ordered separately.

BU-530
Bulones para
Culata de Cilindros
Parafusos de Cabeçote2726800
Arand. Goma Inyector
Arruela Borracha
InjetorRT-9828Vit
Porta Retén Bancada
Flange Tras. do Virabrequim
A 311-R 85,00JSA-316
Salida Escape
Saída Escapamento

Juego Completo de Reparación:

Jogo de Juntas do Motor / Full Set Gasket:

JR-761

DESCRIPCIÓN / Descrição / Description

VOLKSWAGEN: Up! 2013/...**Semi-Juego de Reparación:**

Semi-Jogo de Juntas / Semi-Set Gasket:

SJ-761**Juego de Descarbonización:**

Jogo de Juntas Superior / Head Set Gasket:

JD-761

JUNTA CULATA DE CILINDROS	TC-745-15	∅ 75.50mm	1.00mm	↑ ↓
	TC-745-MG	∅ 75.50mm	1.00mm	↑ ↓
Junta de cabeçote		∅		↑ ↓
Cylinder Head gasket		∅		↑ ↓

MOTOR / Engine

CM³

HP

∅ PISTON

CHYA

999

60

74.50

CHYB

999

75

74.50

ILLINOIS

VOLKSWAGEN

JD-761

MENÚ

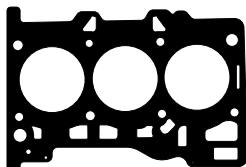

TC-745 - 04C103383H
Junta Culata de Cilindros
Junta Cabeçote



JAE-630-A
Juego Admisión
Jogo Admissão



2729000
O'ring 44x 3,53mm

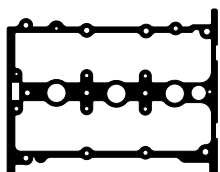

JVS-413-15 - 04C103483B
Junta Tapa Válvula Superior
Junta Tampa Válvula Superior



2703800 - 04E121119D
Termostato



2769400
O'ring 11 x 3mm



JSA-340
Salida Escape
Saída Escapamento



Juego ret. guía de Válvulas
Jogo Retentor da Haste
de Válvulas



Retén Árbol de Levas
Retentor do Eixo Comando de Válvulas
36,00 x 46,00 x 7,00



Retén Auxiliar
Retentor Auxiliar
24,00 x 39,00 x 8,00



1403100 - 04C103161D/E
Distribución
Distribuição



2777800 - 04E121119C
Bomba de agua
Bomba de água



2703900 - 04E121119C
Bomba de agua
Bomba de água



Retén Auxiliar
Retentor Auxiliar
30,00 x 40,00 x 7,00

Productos relacionados no incluidos en el juego. Los mismos pueden ser solicitados por separado.

Produtos relacionados não incluídos no jogo. Podem ser solicitados em separado.

Related products that were not included in the set but can be ordered separately.

DESCRIPCIÓN / Descrição / Description

VOLKSWAGEN: Pick Up Kombi Bus - Sedan Beetle 1965/... - Escarabajo - Fusca - Variant Transporter - Brasília - Kharmann (1111980072)

MOTOR / Engine	CM ³	HP	Ø PISTON
E - F - AB - AC - AR	1285	46	77.00
H - K - L - N - M	1493	52	83.00
T - AF - AD	1584	65	83.50
Refrigerado a aire			

Juego Completo de Reparación:

Jogo de Juntas do Motor / Full Set Gasket:

JR-285-07

Semi-Juego de Reparación:

Semi-Jogo de Juntas / Semi-Set Gasket:

Juego de Descarbonización:

Jogo de Juntas Superior / Head Set Gasket:

JUNTA CULATA DE CILINDROS				
Junta de cabeçote	Ø	Ø	Ø	Ø
Cylinder Head gasket	Ø	Ø	Ø	Ø



JVS-223-30 - 113101841F
Junta Tapa Válvula
Junta Tampa Válvula



11215189
Cuerpo bomba de aceite
Corpo bomba de óleo



113101219
Respiradero motor
Respirador motor



JAE-321-09 - 111251261
Juego Escape
Jogo Escapamento



Tubo precalentador
Tubo preaquecedor



N137781
Base carburador
Base carburador



311129707B
Tubo Admisión
Tubo Admissão



111115131B
Bomba de Aceite
Bomba de óleo



Ventilador dinamo
Ventilador dinamo



Junta



113127313
Base bomba de nafta
Base bomba de gasolina



113127311
Base bomba de nafta inferior
Base bomba de gasolina inferior



Junta



Caja Bomba de Aceite
Caixa Bomba de Óleo



Brida Flange



111115131A
Bomba de aceite
Bomba de óleo



Junta



Junta



311117151A
Radiador aceite
Radiador óleo



Tubo Admisión
Tubo Admissão



Arandela Camisa
Arruela Camisa



Tubo balancines
Tubo balancins

Juego Arandelas Metálicas/Jogo Arruelas Metálicas

Gráfico	Descripción/Descrição	Cant./Quant.
○	Aran./Arruela 32x38x3mm Aluminio	2
○	Aran./Arru. 18x24x1,5mm Aluminio	1
○	Aran./Arru. 14x21,5x2mm Aluminio	1
○	Aran./Arruela 6x10x1mm Aluminio	6

Juego Arandelas de Goma/Jogo Arruelas de Borracha

Gráfico	Descripción/Descrição	Cant./Quant.
○	O'ring 52x2mm	1
○	O'ring 22x3mm	1
○	O'ring 10x4mm	6
○	Arandela/Arruela 9x13x9,5mm	4
○	Arandela/Arruela 8x12x2mm	8
○	O'ring 8x2,5mm	4

Productos relacionados no incluidos en el juego. Los mismos pueden ser solicitados por separado.

Produtos relacionados não incluídos no jogo. Podem ser solicitados em separado.

Related products that were not included in the set but can be ordered separately.

Juego Completo de Reparación:

Jogo de Juntas do Motor / Full Set Gasket:

JR-516**Semi-Juego de Reparación:**

Semi-Jogo de Juntas / Semi-Set Gasket:

SJ-516**Juego de Descarbonización:**

Jogo de Juntas Superior / Head Set Gasket:

JD-516

JUNTA CULATA DE CILINDROS Junta de cabeçote Cylinder Head gasket	TC-784-15	∅ 77.50mm	1.30mm	↑ ↓
	TC-784-MG	∅ 77.50mm	1.30mm	↑ ↓
	TC-784-18	∅ 77.50mm	2.30mm	↑ ↓

DESCRIPCIÓN / Descrição / Description

VOLKSWAGEN: Polo 2003/05 - Caddy 1997/01
Gol 2001/... - Gol Trend - Fox 2005/... - Fox Route
Suran 2006/... - Voyage - Derby - Pointer - Lupo
Combi Brasil 2006/14 - Van - Sport Van
SEAT: Ibiza - Cordoba 2003/...

MOTOR / Engine	CM ³	HP	∅ PISTON
AUD/AKK/BKR/BLM	1391	75	76.50
BAH/BJA/BPA/BLH	1595	100	76.50

ILLINOIS

VOLKSWAGEN

JD-516

TC-784 - 032103383N
Junta Culata de Cilindros
Junta Cabeçote



JSA-316
Salida Escape
Saída Escapamento



2726300 - 036133073
Arandela 64 x 69 x 5mm
Arruela (Sintético)



RT-994Pol
Juego Ret. Guía Válvulas
Jogo Retentor da Haste de Válvulas



JAE-507-E - 030253039K
Junta Escape
Junta Escapamento



JSA-251
Salida Escape
Saída Escapamento



JAE-474-A - 030124717F
Juego Admisión
Jogo Admissão



RT-9912Vit
Retén Árbol de Leva
Retentor do Eixo Comando de Válvulas
32,00 x 42,00 x 8,00



JVS-390-28
Junta Tapa de Válvula
Junta Tampa de Válvula



1136400 - 032103161K
Distribución
Distribuição



2712000 - 030121005
Termostato
O'ring 46,8 x 4mm

2727800 - Juego Arandelas de Goma/Jogo Arruelas de Borracha

Gráfico	Descripción/Descrição	Cant./Quant.
	O'ring 48x4,3mm	2
	O'ring 36,5x3,53mm	1
	O'ring 32x3,8mm	2
	O'ring 28,17x3,53mm	1
	O'ring 7,52x3,53mm Inyec./Injeção	8

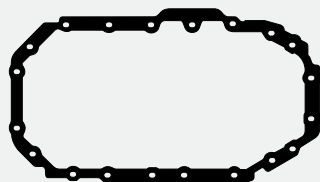

JC-398-25 - 032103601AA
Junta Cáster
Junta Carter

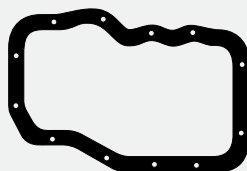

JC-354-26 - 032103601AA
Junta Sobre Cáster
Junta Sobre Carter



2765300
O'ring bomba de agua
a conexión distribuidora (BAH)
Bomba de água ao conexão
distribuidora



2606900
Arandela tapón cárter
Arruela tampão carter
14 x 20 x 1,5mm



2712500 - 036103677
Guarnición llenado deflector
Guarnição enchimento defletor



1136700 - 036115111
Bomba de aceite
Bomba de óleo



RT-9912Vit
Retén Distribución
Retentor Dianteiro do
Virabrequim
Lx-R 32,00 x 42,00 x 8,00

2727900 - Juego Arandelas de Goma/Jogo Arruelas de Borracha

Gráfico	Descripción/Descrição	Cant./Quant.
	O'ring 67,5x4mm	1
	O'ring 60x4mm	1
	O'ring 37x4mm	1
	O'ring 30x3,5mm	1
	Asiento Inyector/Assento Injetor	4

Productos relacionados no incluidos en el juego. Los mismos pueden ser solicitados por separado.

Produtos relacionados não incluídos no jogo. Podem ser solicitados em separado.

Related products that were not included in the set but can be ordered separately.



RT-9828Vit
Porta Retén Bancada
Flange Traseiro do
Virabrequim
A 311-R 85,00



RT-3007
Porta Retén Bancada
Flange Traseiro do
Virabrequim
(Sensor Cuad./Quadrado)



RT-3006
Porta Retén Bancada
Flange Traseiro do
Virabrequim
(Sensor Redondo)



RT-1286Tef
Porta Retén Bancada
Flange Traseiro do
Virabrequim
(Sensor c/guía - Gol Trend)



JSA-317-21
Junta Salida Escape
(Anillo Malla Acero)
Junta Saída Escap.
(Anel Malha Aço)



JC-398-25
Junta Cáster
Junta Carter

DESCRIPCIÓN / Descrição / Description

VOLKSWAGEN: Passat - Golf - Dasher (USA)
Scirocco - Rabbit Brasil 1974/82

MOTOR / Engine	CM ³	HP	Ø PISTON
ZC/YJ/FL/FB	1457	65/85	76.50
FD/FH/FK	1457	65/85	76.50

Juego Completo de Reparación:

Jogo de Juntas do Motor / Full Set Gasket:

JR-453-15



Semi-Juego de Reparación:

Semi-Jogo de Juntas / Semi-Set Gasket:

SJ-453



Juego de Descarbonización:

Jogo de Juntas Superior / Head Set Gasket:

JD-453-15



JUNTA CULATA DE CILINDROS	TC-434-15	Ø 79.00mm	1.70mm	↑	↓
Junta de cabeçote				↑	↓
Cylinder Head gasket				↑	↓

JD-453-15

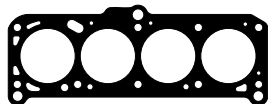

TC-434-15
Junta Culata de Cilindros
Junta Cabeçote



JAE-336-A - 056129717
Junta Admisión
Junta Admissão



JVS-358-30
Junta Tapa Válvula Superior
Junta Tampa Válvula Superior



JSA-200 - 841253115B
Salida Escape
Saída Escapamento



JAE-337-E - 056129589A
028129589B
Juego Escape
Jogo Escapamento



1114100 - 056121149
Conector
Conector



1114000 - 056121139B
Entrada agua
Entrada água



1117700
Base carburador
Base carburador



2608500
Arandela 14 x 18 x 1,5mm
Arruela (Aluminio)



RT-562Pol
Juego Ret. Guía Válvulas
Jogo Retenedor da Haste de Válvulas



RT-8422Pol
Retén Árbol de Levas
Retenedor do Eixo Comando de Válvulas
Lx-Bidi 32,00 x 47,00 x 10,00



JC-278-30 - 056103609B/049103609I
Junta Cártier
Junta Carter



1113500 - 026103181B
Bancada trasera
Virabrequim traseira



1113600 - 056103161
Bancada delantera
Virabrequim dianteira



1113900 - 056121041
Bomba de agua
Bomba de água



1113200 - 056905261
Base distribuidor
Base distribuidor



1144800 - 059127311A
Bomba de combustible
Bomba de combustível



1113800 - 056115441
Base filtro aceite
Base filtro óleo



2736000 - 059121119
O'ring termostato
50 x 3,9mm



2737200 - 90353501/056115037
O'ring 56,4 x 1,78mm
eje intermedio
eixo intermediário



2736400
O'ring 35,3 x 3mm
Conexión TC a calefactor
Conexão TC a aquecedor



RT-6863Vit
Retén Bancada
Retenedor Traseiro do Virabrequim
Lx-R 85,00 x 105,00 x 12,00



RT-8422Pol
Retén Distribución
Retenedor Dianteiro do Virabrequim
Lx-Bidi 32,00 x 47,00 x 10,00



Productos relacionados no incluidos en el juego. Los mismos pueden ser solicitados por separado.

Produtos relacionados não incluídos no jogo. Podem ser solicitados em separado.

Related products that were not included in the set but can be ordered separately.



BU-042
Bulones para Culata de Cilindros
Parafusos de Cabeçote



JC-278-15
JC-278-23
Junta Cártier
Junta Carter



JC-278-43
Junta Cártier
Junta Carter (Sintético)



JAE-337-09
056129589A
Juego Escape
Jogo Escapamento

Juego Completo de Reparación:

Jogo de Juntas do Motor / Full Set Gasket:

JR-302-15**R****Semi-Juego de Reparación:**

Semi-Jogo de Juntas / Semi-Set Gasket:

SJ-240**R****Juego de Descarbonización:**

Jogo de Juntas Superior / Head Set Gasket:

JD-129-15**R**

JUNTA CULATA DE CILINDROS	TC-456-15	Ø 81.20mm	1.60mm	±0.05
Junta de cabeçote	TC-456-18	Ø 81.20mm	2.30mm	±0.05
Cylinder Head gasket				

DESCRIPCIÓN / Descrição / Description

VOLKSWAGEN: Caddy - Passat - Jetta - Lupo Van - Gol - Golf - Gacel 1975/84 - Fox 79/83

Coupe 80/81 - Pointer - Santana

AUDI: 4000 - 80 - 4E - 100

MOTOR / Engine	CM ³	HP	Ø PISTON
YN/YP/YH/YT/Y5	1588	110	79.50
VY/VZ/YW/YN	1588	75/85	79.50
EM/FS/FT/FR/FN	1588	75/110	79.50
FP/WP/WY/WV	1588	75/110	79.50

ILLINOIS

VOLKSWAGEN

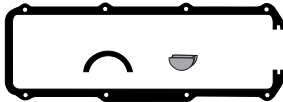
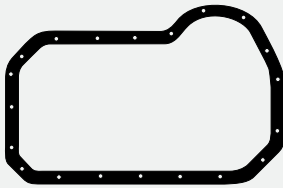
**JD-129-15****TC-456-15** - 049103383A
Junta Culata de Cilindros
Junta Cabeçote**JAE-336-A** - 056129717
Junta Admisión
Junta Admissão**JVS-231-KIT** - 056103483C
Junta Tapa Válvula Superior
Junta Tampa Válvula Superior**JSA-185** - 843253115B
Salida Escape
Saída Escapamento**JAE-337-E** - 056129589A
028129589B/037253039D
Juego Escape
Jogo Escapamento**1114200** - 059129799D
Base carburador
Base carburador**1114100** - 056121149
Conector
Conector**1114000** - 056121139B
Entrada agua
Entrada água**2736400**
O'ring 35,3 x 3mm
Conexión TC a calefactor
Conexão TC ao aquecedor**RT-562Pol**
Juego Ret. Guía Válvulas
Jogo Retenedor da Haste de Válvulas**RT-8422Pol**
Retén Distribución y Árbol de Levas
Retenedor Dianteiro do Virabrequim e do Eixo Comando de Válvulas
Lx-Bidi 32,00 x 47,00 x 10,00**JC-278-30** - 056103609B/049103609I
Junta Cártér
Junta Carter**1113500** - 026103181B
Bancada trasera
Virabrequim traseira**1113600** - 056103161
Bancada delantera
Virabrequim dianteira**1113900** - 056121041
Bomba de agua
Bomba de água**1197100**
Bomba de aceite
Bomba de óleo**1144800** - 059127311A
Bomba de combustible
Bomba de combustível**1113800** - 056115441
Base filtro aceite
Base filtro óleo**1113200** - 026905261A
Base distribuidor
Base distribuidor**2736000** - 059121119
O'ring termostato
50 x 3,9mm**2610600** - 105452
Arandela 14 x 20 x 1,5mm
Arruela (Aluminio)**2737200** - 90353501/056115037
O'ring 56,4 x 1,78mm
eje intermedio
eixo intermediário**2736500** - N/901814/01
O'ring 60 x 5mm
refrigeración aceite
refrigeração óleo**RT-6863Vit**
Retén Bancada
Retenedor Traseiro do Virabrequim
Lx-R 85,00 x 105,00 x 12,00**RT-8422Pol**
Retén Distribución y Árbol de Levas
Ret. Diant. do Virab. e Eixo Comando Válv.
Lx-Bidi 32,00 x 47,00 x 10,00

Productos relacionados no incluidos en el juego. Los mismos pueden ser solicitados por separado

Produtos relacionados não incluídos no jogo. Podem ser solicitados em separado / Related products that were not included in the set but can be ordered separately.

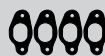
**BU-042**
Bulones para
Culata de Cilindros
Parafusos de
Cabeçote**JB-196**
Juego/Jogo
Carburador**JSA-198-21**
Salida Escape
Saída Escapam.
(Anillo Malla Acero)
(Anel Malha Aço)**JAE-337-09**
056129589A
Juego Escape
Jogo Escapam.**JVS-231-23** - 056103483C
JVS-231-30 - 056103483C
Junta Tapa Válvula Superior
Junta Tampa Válvula Superior**JSA-185-11**
841253115B
Salida Escape
Saída Escap.**JSA-304-21**
Salida Escape
(An. Malla Acero)
S. Escap. (An. Malha Aço)**JB-210**
Juego/Jogo
Carburador**JSA-198-22**
Salida Escape (Fund.)
Saída Escap. (Ferro)**JSA-334**
Catalizador
Catalisador**JC-278-15**
JC-278-23
Junta Cártér**JC-278-43**
Junta Cártér
(Sintético)**JV-140**
Jgo. Caja Vel.
Jogo Caixa de Câmbio

DESCRIPCIÓN / Descrição / Description

DIESEL

VOLKSWAGEN: Senda - Saveiro - Gol - Caddy
 Golf - Passat - Kombi - Santana 1981/86 - Jetta
AUDI: 80 D/TD 1981/85

MOTOR / Engine	CM ³	HP	Ø PISTON
CR/JK/DR/JF/C5	1588	54/70	76.50

Juego Completo de Reparación:

Jogo de Juntas do Motor / Full Set Gasket:

Semi-Juego de Reparación:

Semi-Jogo de Juntas / Semi-Set Gasket:

SJ-242**R****Juego de Descarbonización:**

Jogo de Juntas Superior / Head Set Gasket:

JD-148-ST**R**

JUNTA CULATA DE CILINDROS	TC-527-20 1M	Ø 78.30mm	1.40mm	de 0,67 a 0,82mm
	TC-527-20 2M	Ø 78.30mm	1.50mm	de 0,83 a 0,92mm
	TC-527-20 3M	Ø 78.30mm	1.60mm	de 0,93 a 1,02mm
	TC-527-20 4M	Ø 78.30mm	1.70mm	de 1,03 a 1,12mm
	TC-527-20 5M	Ø 78.30mm	1.90mm	de 1,12mm ...

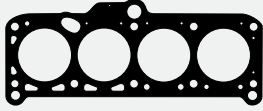

TC-527-20 1M - 068103383BC
TC-527-20 2M - 068103383BD
TC-527-20 3M - 068103383BE
TC-527-20 4M - 056103483C
TC-527-20 5M
 Junta Culata de Cilindros
 Junta Cabeçote

JD-148-ST

2627000
 Arandela parallama (Acero)
 Arruela Bico Injetor (Aço)



JSA-200 - 841253115B
 Salida Escape
 Saída Escapamento



1114000 - 056121139B
 Entrada agua
 Entrada água



JVS-231-KIT - 056103483C
 Junta Tapa Válvula Superior
 Junta Tampa Válvula Superior



JAE-336-A - 056129717
 Junta Admisión
 Junta Admissão

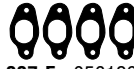

JAE-337-E - 056129589A
 028129589B
 Juego Escape
 Jogo Escapamento



RT-8422Pol
 Retén Distribución
 y Árbol de Levas
 Retenedor Distribuição
 y Arvore de Comando
 Lx-Bidi 32,00 x 47,00 x 10,00



1114100 - 056121149
 Conector
 Conector



1136500 - 052121091
 Conexión agua
 Conexão água



2736400
 O'ring 35,3 x 3mm
 conexión TC a calefactor
 conexão cabeçote a aquecedor



RT-562Pol
 Juego Retenes Guía de Válvulas
 Jogo Retenedor haste de Válvulas

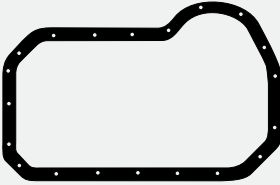

JC-278-30 - 056103609B
 0491036091
 Junta Cártér
 Junta Carter



1113400 - 049121041B
 056121041A
 Bomba de agua
 Bomba de água



1197100
 Bomba de aceite
 Bomba de óleo



1195100 - 056103609A
 Brida
 Flange



2736500 - N/901814/01
 O'ring 60 x 5mm
 refrigeración aceite



1144800 - 059127311A
 Bomba de combustible
 Bomba de combustível



1113800 - 056115441
 Base filtro aceite
 Base filtro óleo



1113200 - 026905261A
 Base distribuidor
 Base distribuidor



2737200 - 90353501/056115037
 O'ring 56,4 x 1,78mm
 eje intermedio



2736000 - 059121119
 O'ring termostato 50 x 3,9mm



1113600 - 056103161
 Bancada delantera
 Virabrequim dianteira



1113500 - 026103181B
 Bancada trasera
 Virabrequim traseira



RT-8422Pol
 Retén Distribución y Árbol de Levas
 Ret. Distribuição y Arvore de Comando
 Lx-Bidi 32,00 x 47,00 x 10,00



RT-6863Vit
 Retén Bancada
 Retenedor Traseiro do Virabrequim
 Lx-R 85,00 x 105,00 x 12,00

Productos relacionados no incluidos en el juego. Los mismos pueden ser solicitados por separado

Produtos relacionados não incluídos no jogo. Podem ser solicitados em separado / Related products that were not included in the set but can be ordered separately.



BU-043
 Bulones Culata de Cilindros
 Parafusos de Cabeçote



JSA-334
 Catalizador
 Catalisador



JV-141
 Jgo. Caja Velocidad
 Jogo Caixa de Câmbio



JSA-198-22
 Salida Escape
 Saída Escapamento
 (Fundición/Ferro)



JSA-198-21
 Salida Escape
 Saída Escapamento
 (Anillo Malla Acero/
 Anel Malha Aço)



JSA-299-21
 Salida Escape
 Saída Escapamento
 (Anillo Malla Acero/
 Anel Malha Aço)



JVS-231-23 / JVS-231-30
 Junta Tapa Válv. Superior
 Junta Tampa Válv. Superior



JC-278-15
JC-278-23
 Junta Cártér/Carter



JC-278-43
 Junta Cártér/Carter
 (Sintético)



JAE-337-09 - 056129589A
 Juego Escape
 Jogo Escapamento

Juego Completo de Reparación:

Jogo de Juntas do Motor / Full Set Gasket:

JR-475-15

DESCRIPCIÓN / Descrição / Description

VOLKSWAGEN: Golf 1997/... - Polo 1999/... - Bora 1998/...
 Passat 1996/... - New Beetle - **AUDI:** A3 1996/...
SEAT: Toledo - Cordoba 2001/05 - Ibiza 2001/03
 Leon 1999/... - **SKODA:** Octavia 1997/...

Semi-Juego de Reparación:

Semi-Jogo de Juntas / Semi-Set Gasket:

SJ-475**Juego de Descarbonización:**

Jogo de Juntas Superior / Head Set Gasket:

JD-475-15

JUNTA CULATA DE CILINDROS	TC-816-15	∅ 82.50mm	1.50mm	↑ ↓
Junta de cabeçote	TC-816-11	∅ 82.50mm	2.20mm	↑ ↓
Cylinder Head gasket				↑ ↓

MOTOR / Engine	CM ³	HP	∅ PISTON
AKL/AHL/ANA/AYD	1595	100	81.00
ARM/AEH/APF/AVU	1595	100	81.00

ILLINOIS

VOLKSWAGEN

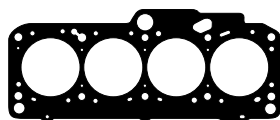
JD-475-15

TC-816-15 - 06A/103383/L
 Junta Culata de Cilindros
 Junta Cabeçote



JAE-556-E - 037253039D
 Junta Escape
 Junta Escapamento



JAE-555-A
 Juego Admisión
 Jogo Admissão

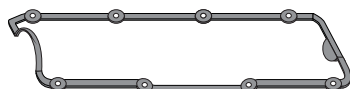

JVS-266-43 - 02610344832
 Junta Tapa Válvula Superior
 Junta Tampa Válvula Superior



RT-9911Vit
 Retén Árbol de Levas y Distribución
 Retentor do Eixo Comando de Válvulas e
 Dianteiro do Virabrequim
 Lx-R 35,00 x 48,00 x 10,00



RT-564Pol
 Juego Ret. Guía Válvulas
 Jogo Retentor da Haste de Válvulas

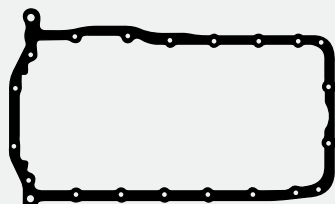

JC-381-15
 Junta Cártér
 Junta Carter



1130700 - 035121171/C
 Distribución
 Distribuição



1133300
 Distribución
 Distribuição



JSA-221 - 533253155
 Salida Escape
 Saída Escapamento



1155400
 Deflector
 Defletor



1177400 - 028115441C
 Filtro de aceite
 Filtro de óleo



1130600
 Junta



2714400
 O'ring 19 x 3mm



2606900
 Arandela
 Arruela (Cobre)
 14 x 20 x 1,5mm



2760600
 O'ring 72,62 x 3,53mm



2704400
 O'ring 50,39 x 3,53mm



2761800
 O'ring 53 x 3,6mm



RT-9912Vit
 Retén Distribución
 Retentor Dianteiro do Virabrequim
 Lx-R 32,00 x 42,00 x 8,00

Productos relacionados no incluidos en el juego. Los mismos pueden ser solicitados por separado.

Produtos relacionados não incluídos no jogo. Podem ser solicitados em separado.

Related products that were not included in the set but can be ordered separately.



BU-229
 Bulones para Culata de Cilindros
 Parafusos de Cabeçote



JC-381-30
 Junta Cártér
 Junta Carter



JB-265-INY
 Juego Carburador
 Jogo Carburador



RT-9828Vit
 Porta Reten Bancada
 Flange Traseiro do Virabrequim

DESCRIPCIÓN / Descrição / Description

VOLKSWAGEN: Golf - Polo - Passat - Vento
Gol/Dublin - Derby - Bora - Pointer
SEAT: Ibiza - Cordoba - Toledo 1993/...

MOTOR / Engine	CM ³	HP	Ø PISTON
IF AFT/ADZ	1595	70/71	81.00
IF AFT/ADZ	1781	75/90	81.00

Juego Completo de Reparación:

Jogo de Juntas do Motor / Full Set Gasket:

JR-510**R****Semi-Juego de Reparación:**

Semi-Jogo de Juntas / Semi-Set Gasket:

SJ-510**R****Juego de Descarbonización:**

Jogo de Juntas Superior / Head Set Gasket:

JD-510**R**

JUNTA CULATA DE CILINDROS	TC-498-15	Ø 82.00mm	1.60mm	±0.05
Cilindros	TC-498-MG	Ø 82.00mm	1.60mm	±0.05
Junta de cabeçote	TC-498-18	Ø 82.00mm	2.30mm	±0.05
Cylinder Head gasket				

JD-510

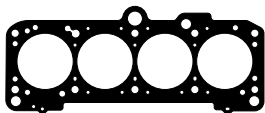

TC-498
Junta Culata de Cilindros
Junta Cabeçote



JAE-337-E - 056129589A
028129589B
Juego Escape
Jogo Escapamento

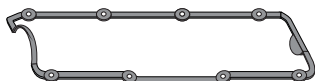

JVS-266-43 - 0291034831
Junta Tapa Válvula Superior
Junta Tampa Válvula Superior



JAE-339-A - 026129717
048129717D
Junta Admisión
Junta Admissão



JAE-336-A - 056129717
Junta Admisión
Junta Admissão



2736400
O'ring 35,3 x 3mm



2736600
Conducto admisión
Conduto de admissão



JSA-253
Salida Escape
Saída Escapamento



RT-564Pol
Juego Retenes Guía de Válvulas
Jogo Retentor da Haste de Válvulas



RT-8422Pol
Retén Árbol de Levas
Retentor do Eixo Comando
de Válvulas
Lx 32,00 x 47,00 x 7,00



JC-278-15 - 044103609D
Junta Cártér
Junta Carter



1113500 - 026103181B
Bancada trasera
Mancal traseira



1197100
Bomba de aceite
Bomba de óleo



1114000 - 056121139B
Entrada agua
Entrada água



1113400 - 049121041B/056121041A
Bomba de agua
Bomba de água



1113600 - 056103161
Bancada delantera
Mancal dianteira



1113200 - 026905261A
Base distribuidor
Base distribuidor



1113800 - 056115441
Base filtro aceite
Base filtro óleo



1144800 - 059127311A
Bomba de combustible
Bomba de combustível



2606900
Arandela
Arruela (Cobre)
14 x 20 x 1,5mm

2726900 - Juego Arandelas de Goma/Jogo Arruelas de Borracha

Gráfico	Descripción/Descrição	Cant./Quant.
	O'ring 60 x 5mm Refrigeración aceite	1
	O'ring 56,4 x 1,78mm Eje intermedio	1
	O'ring 50 x 3,9mm Termostato	1



RT-8422Pol
Retén Distribución
Ret. Dianteiro do Virabrequim
32,00 x 47,00 x 7,00



RT-6863Vit
Retén Bancada
Retentor Traseiro do Virabrequim
Lx-R 85,00 x 105,00 x 12,00

Productos relacionados no incluidos en el juego. Los mismos pueden ser solicitados por separado

Produtos relacionados não incluídos no jogo. Podem ser solicitados em separado / Related products that were not included in the set but can be ordered separately.



BU-044
Bulones para
Culata de Cilindros
Parafusos de Cabeçote



JV-141
Jgo. Caja Velocidad
Jogo Caixa
de Câmbio



JC-278-23
JC-278-30
Junta Cártér
Junta Carter



JC-278-43
Junta Cártér
Junta Carter
(Sintético)



JAE-337-09
056129589A
Juego Escape
Jogo Escapamento



JSA-185
JSA-185-11
Salida Escape
Saída Escapamento



JSA-210
Salida Escape
Saída Escapamento



JSA-221
Salida Escape
Saída
Escapamento



2754900
Tubo Sellador
Válvula Venteo
Tubo vedação

Juego Completo de Reparación:

Jogo de Juntas do Motor / Full Set Gasket:

JR-326-15**Semi-Juego de Reparación:**

Semi-Jogo de Juntas / Semi-Set Gasket:

SJ-241**Juego de Descarbonización:**

Jogo de Juntas Superior / Head Set Gasket:

JD-130-15

JUNTA CULATA DE CILINDROS	TC-497-15	Ø 82.00mm	1.60mm	±0.05
	TC-497-MG	Ø 82.00mm	1.60mm	±0.05
Junta de cabeçote	TC-497-18	Ø 82.00mm	2.30mm	±0.05
Cylinder Head gasket				±0.05

DESCRIPCIÓN / Descrição / Description

VOLKSWAGEN: Gacel - Senda - Carat - Voyage
Fox - Gol - Golf - Passat - Polo Classic - Pointer
Santana - Lupo - Derby

FORD: Escort - Orion - Scala - Pampa - Belina

MOTOR / Engine	CM ³	HP	Ø PISTON
AP	1595	70	81.00
AP	1781	85/87	81.00

ILLINOIS

VOLKSWAGEN

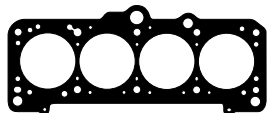
**JD-130-15**

TC-497-15 - 0261033831
Junta Culata de Cilindros
Junta Cabeçote



JAE-339-A - 026129717
048129717D
Junta Admisión
Junta Admissão



JVS-231-KIT - 056103483C
Junta Tapa Válvula Superior
Junta Tampa Válvula Superior

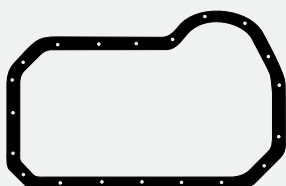

JC-278-30 - 056103609B
049103609I
Junta Carter
Junta Carter



1113500 - 056103181B
Bancada trasera
Mancal traseira



1113400 - 049121041B
056121041A
Bomba de agua
Bomba de água



JSA-185 - 843253115B
Salida Escape
Saída Escapamento



JAE-337-E - 056129589A
028129589B/037253039D
Juego Escape
Jogo Escapamento



1114200 - 059129799D
Base carburador
Base carburador



2610600 - 105452
Arandela
Arruela (Aluminio)
14 x 20 x 1,5mm



1197100
Bomba de aceite
Bomba de óleo



1113600 - 056103161
Bancada delantera
Mancal dianteira



1113800 - 056115441
Base filtro aceite
Base filtro óleo



2736400 - 059127311B
Bomba de combustible
Bomba de combustível
O'ring 35,3 x 3mm



2736300
O'ring 35,8 x 3,6mm
Conexión TC a calefactor
Conxão TC a aquecedor



1177300 - 129799/94649659
Base carburador Brosol
Base carburador Brosol



RT-562Pol
Juego Retenes Guía Válvulas
Jogo Retedor da Haste
de Válvulas



RT-8422Pol
Retén Árbol de Levas
Ret. do Eixo Comando de Válvulas
Lx-Bidi 32,00 x 47,00 x 7,00



1113200 - 026905261A
Base distribuidor
Base distribuidor



2737200 - 90353501/056115037
O'ring 56,4 x 1,78mm
eje intermedio
eixo intermediário



RT-6864Pol
Retén Distribución
Retedor Dianteiro do Virabrequim
Lx-Bidi 32,00 x 47,00 x 10,00



RT-6863Vit
Retén Bancada
Retedor Traseiro do Virabrequim
Lx-R 85,00 x 105,00 x 12,00



2736500 - N/901814/01
O'ring 60 x 5mm
refrigeración aceite
refrigeração óleo



1144800 - 059127311A
Bomba de combustible
Bomba de combustível

Productos relacionados no incluidos en el juego. Los mismos pueden ser solicitados por separado

Produtos relacionados não incluídos no jogo. Podem ser solicitados em separado / Related products that were not included in the set but can be ordered separately.



BU-042
BU-049
Bulones para
Culata de Cilindros
Parafusos de
Cabeçote



JAE-337-09
Jgo. Escape
Escapamento



JV-141
Jgo. Caja Vel.
Jogo Caixa
de Câmbio



JSA-334
Catalizador
Catalisador



JSA-193-21
Salida Escape
Saída Escapam.



JSA-193-22
Salida Escape
Saída Escapam.



JSA-304-21
Salida Escape
Saída Escapam.



JB-188
Jgo.
Carburador



JSA-221
Salida Escape
Saída Escapam.



2754900
Tubo Sellador
Válvula Ventoe
Tubo vedação



JSA-185-11
Salida Escape
Saída Escapam.



JB-217
Jgo.
Carburador



JB-241-INY
Jgo.
Carburador



JB-245
Jgo.
Carburador



JB-254-INY
Jgo.
Carburador



JB-265-INY
Jgo.
Carburador



JB-209
Jgo.
Carburador



JC-278-15
JC-278-23
JC-278-43
Junta Carter

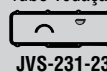

JVS-231-23
JVS-231-30
Junta Tapa/
Tampa Válvula

DESCRIPCIÓN / Descrição / Description

VOLKSWAGEN: Suran - Suran Cross - Saveiro
Saveiro Cross 2015/... - Novo Fox - Gol Rallye
Polo 2017/... - Virtus 2018/... - Voyage

MOTOR / Engine	CM ³	HP	Ø PISTON
CWVA (EA211 MSI) 16V	1598	110	76.50
CWVB (EA211 MSI) 16V	1598	90	76.50

Juego Completo de Reparación:

Jogo de Juntas do Motor / Full Set Gasket:

JR-718-15**R****Semi-Juego de Reparación:**

Semi-Jogo de Juntas / Semi-Set Gasket:

SJ-718**R****Juego de Descarbonización:**

Jogo de Juntas Superior / Head Set Gasket:

JD-718-15**R**

JUNTA CULATA DE CILINDROS	TC-928-15	Ø 77.00mm	1.50mm	↑ ↓
Junta de cabeçote				↑ ↓
Cylinder Head gasket				↑ ↓

JD-718-15

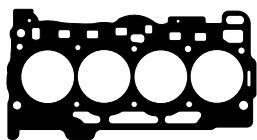

TC-928-15 - 04E103383BE
Junta Culata de Cilindros
Junta Cabeçote

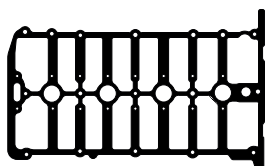

JVS-409-15 - 04E103483N
Junta Tapa Válvula Superior
Junta Tampa Válvula Superior



JSA-338 - 1S0253115B
Salida Escape
Saída Escapamento



JAE-576-A - 04C129717D
Juego múltiple admisión
Jogo coletor admissão



Juego Retenes Guía de Válvulas
Jogo Retentor da Haste
de Válvulas



Retén Árbol de Levas
Retentor do Eixo Comando
de Válvulas
36,00 x 46,00 x 7,00



1063200 - 04C103161E
Distribución
Distribuição



2764700 - 04E121119P
Bomba de agua
Bomba d'água



Retén Bomba de agua
Retentor Bomba d'água
24,00 x 39,00 x 8,00



Retén Distribución
Retentor Dianteiro do Virabrequim
30,00 x 40,00 x 7,00

Productos relacionados no incluidos en el juego. Los mismos pueden ser solicitados por separado.

Produtos relacionados não incluídos no jogo. Podem ser solicitados em separado.

Related products that were not included in the set but can be ordered separately.

Juego Completo de Reparación:

Jogo de Juntas do Motor / Full Set Gasket:

JR-414-15**R****Semi-Juego de Reparación:**

Semi-Jogo de Juntas / Semi-Set Gasket:

SJ-414**R****Juego de Descarbonización:**

Jogo de Juntas Superior / Head Set Gasket:

JD-414-15**R**

JUNTA CULATA DE CILINDROS	TC-815-15	∅ 82.50mm	1.50mm	↑ ↓
Junta de cabeçote	TC-815-11	∅ 82.50mm	2.20mm	↑ ↓
Cylinder Head gasket	TC-815-MG	∅ 82.50mm	1.50mm	↑ ↓

DESCRIPCIÓN / Descrição / Description

VOLKSWAGEN: Passat 1996/...
Passat Turbo 1996/98
AUDI: A4 - A4 Turbo 94/... - A6 - A6 Turbo 95/...
Cabrio 1997/... - A6 Quattro 1999/...

MOTOR / Engine	CM ³	HP	∅ PISTON
AFY/ADR	1781	115/125	81.00
AEB/AJL/ANB	1781	150/180	81.00

ILLINOIS

VOLKSWAGEN

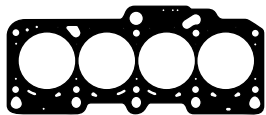
JD-414-15

TC-815-15 - 058103383K
Junta Culata de Cilindros
Junta Cabeçote



2739200 - 5949822
O'ring 36 x 3mm
Salida de agua
Saída de água



2717300
O'ring 28,24 x 2,62mm

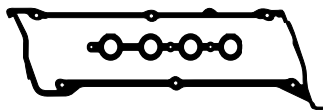

JVS-359-43 - 058103483F/C
Junta Tapa Válvula Superior
Junta Tampa Válvula Superior



JAE-554-A - 058129717B
Junta Admisión
Junta Admissão



JAE-553-E - 058253039G
Junta Escape
Junta Escapamento



2706100 - 90118437
O'ring 50 x 4,2mm



RT-625Pol
Juego Retenes Guía de Válvulas
Jogo Retentor da Haste de Válvulas



RT-8422Pol
Retén Árbol de Levas
Retentor do Eixo Comando de Válvulas
Lx-Bidi 32,00 x 47,00 x 10,00

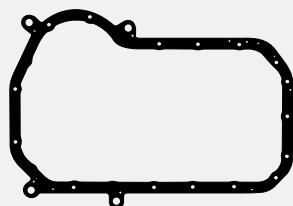

JC-380-26 - 058103609
Junta Carter
Junta Carter



1113500 - 026103181B
Bancada trasera
Virabrequim traseira



1113600 - 056103161
Bancada delantera
Virabrequim dianteira



2748200
Entrada y salida tubo admisión
Entrada y saída tubo admissão
O'ring 34,4 x 3,2mm



2610600 - 105452
Arandela
Arruela (Aluminio)
14 x 20 x 1,5mm



1177400 - 028115441C
Filtro de aceite
Filtro de óleo



2637400 - 036109675
Arandela 28 x 34 x 3mm
Arruela (Aluminio)



JSA-310
Salida Escape
Saída Escapamento



2737200
O'ring 56,87 x 1,78mm



RT-6863Vit
Retén Bancada
Retentor Traseiro do Virabrequim
Lx-R 85,00 x 105,00 x 12,00



RT-8422Pol
Retén Distribución
Retentor Dianteiro do Virabrequim
Lx-Bidi 32,00 x 47,00 x 10,00

Productos relacionados no incluidos en el juego. Los mismos pueden ser solicitados por separado.

Produtos relacionados não incluídos no jogo. Podem ser solicitados em separado.

Related products that were not included in the set but can be ordered separately.



JT-151
Juego/Jogo Turbo

DESCRIPCIÓN / Descrição / Description

VOLKSWAGEN: Golf - Sharan 1997/... - Bora 2000/...

New Beetle - Passat Turbo 99/...

AUDI: A3 - A3 Quattro 1998/... - A3 Turbo 1996/...

A6 1997/...

SEAT: Alhambra - Leon Turbo 1998/...

MOTOR / Engine	CM ³	HP	Ø PISTON
AJP	1781	125	81.00
AGU/AJH/ARZ	1781	150	81.00
AJQ/APP	1781	180	81.00

Juego Completo de Reparación:

Jogo de Juntas do Motor / Full Set Gasket:

JR-517-15**R****Semi-Juego de Reparación:**

Semi-Jogo de Juntas / Semi-Set Gasket:

SJ-517**R****Juego de Descarbonización:**

Jogo de Juntas Superior / Head Set Gasket:

JD-517-15**R**

JUNTA CULATA DE CILINDROS	TC-815-15	Ø 82.50mm	1.50mm
Junta de cabeçote	TC-815-11	Ø 82.50mm	2.20mm
Cylinder Head gasket	TC-815-MG	Ø 82.50mm	1.50mm

JD-517-15**TC-815-15** - 058103383K
Junta Culata de Cilindros
Junta Cabeçote**JAE-553-E** - 058253039G
Junta Escape
Junta Escapamento**JSA-310**
Salida Escape
Saída Escapamento**JVS-359-43** - 058103484F/C
Junta Tapa Válvula Superior
Junta Tampa Válvula Superior**JAE-554-A** - 058129717B
Junta Admisión
Junta Admissão**RT-625Pol**
Juego Retenes Guía de Válvulas
Jogo Retentor da Haste de Válvulas**RT-8422Pol**
Retén Árbol de Levas
Ret. do Eixo Comando de Válv.
32,00 x 47,00 x 10,00**JC-381-30** - 06A103609C
Junta Carter
Junta Carter**JSA-221** - 533253155
Salida Escape
Saída Escapamento**2760800 - Juego Arandelas de Goma/Jogo Arruelas de Borracha**

Gráfico	Descripción/Descrição	Cant./Quant.
	O'ring 72,62x3,53mm	1
	O'ring 56,87x1,78mm	1
	O'ring 53,34x5,33mm	1
	O'ring 50x4,2mm	1
	O'ring 34,5x3,2mm	1
	O'ring 21,89x2,62mm	1
	O'ring 20x3,5mm	1
	O'ring 18,77x1,78mm	1

**1130700** - 035121171/C
Distribución
Distribuição**1133300**
Distribución
Distribuição**1130600**
Junta**1177400** - 028115441C
Filtro de aceite
Filtro de óleo**1155400**
Deflector
Defletor**2637400** - 036109675
Arandela 28 x 34 x 3mm
Arruela (Aluminio)**RT-6863Vit**
Retén Bancada
Retentor Traseiro do Virabrequim
Lx-R 85,00 x 105,00 x 12,00**RT-8422Pol**
Retén Distribución
Ret. Dianteiro do Virabrequim
Lx-Bidi 32,00 x 47,00 x 10,00

Productos relacionados no incluidos en el juego. Los mismos pueden ser solicitados por separado.

Produtos relacionados não incluídos no jogo. Podem ser solicitados em separado.

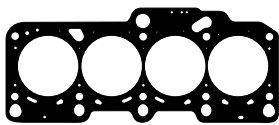
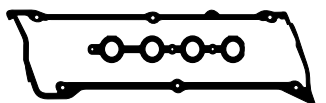
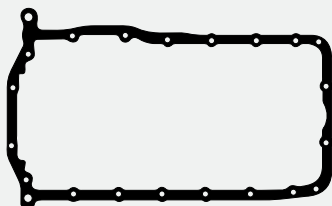
Related products that were not included in the set but can be ordered separately.

**BU-228**
Bulones para Culata de Cilindros
Parafusos de Cabeçote**JC-381-15**
Junta Carter
Junta Carter**JAE-577-A**
Junta Admisión (AGN)
Junta Admissão**JT-151**
Juego Turbo
Jogo Turbo

Juego Completo de Reparación:

Jogo de Juntas do Motor / Full Set Gasket:

JR-826-11

DESCRIPCIÓN / Descrição / Description

VOLKSWAGEN: Golf VI - Jetta - Passat FSI/TSI
 Scirocco - Sharan TSI - Tiguan - Vento TFSI
AUDI: A3 - A4 - A5 - Q5 - TT TFSI
SEAT: Leon TSI 2007/12

MOTOR / Engine	CM ³	HP	Ø PISTON
CDAА/CDAB	1798	160/152	82.50
CAEA/CAEB/CAWA/CAWB	1984	170/200	82.50
CCTA/CCTB/CCZA/CCZB	1984	170/200	82.50
CBFA/CCZC/CDNB/CDNC	1984	170/200	82.50

ILLINOIS.

VOLKSWAGEN

Juego de Descarbonización:

Jogo de Juntas Superior / Head Set Gasket:

JUNTA CULATA DE CILINDROS	TC-743-11	Ø 83.00mm	0.90mm	↕	↕
Junta de cabeçote		Ø	↕	↕	↕
Cylinder Head gasket		Ø	↕	↕	↕

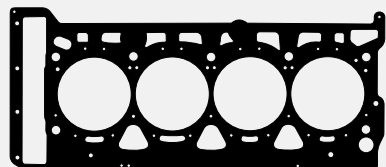

TC-743-11 - 06H103383AC/AD/AF
 Junta Culata de Cilindros
 Junta Cabeçote



Junta



Junta



Junta Escape
 Junta Escapamento

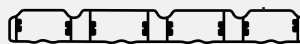

Junta Admisión
 Junta Admissão



Junta

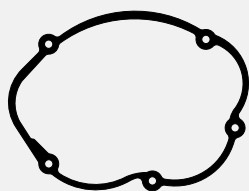

Distribución
 Distribuição



Junta



Junta



Juego Retenes Guía de Válvulas
 Jogo Retentor da Haste de Válvulas



Retén Bancada
 Retentor Traseiro do Virabrequim



Retén Árbol de Leva
 Retentor do Eixo Comando de Válvulas



Productos relacionados no incluidos en el juego. Los mismos pueden ser solicitados por separado.

Produtos relacionados não incluídos no jogo. Podem ser solicitados em separado.

Related products that were not included in the set but can be ordered separately.

DESCRIPCIÓN / Descrição / Description

DIESEL

VOLKSWAGEN: Polo - Golf - Caddy - Passat - Vento
Transporter T.4 1990/92 - Syncro - Caravelle
AUDI: 80 D 1989/91 - 80 TD 1991/95
SEAT: Ibiza - Toledo - Cordoba 1991/93

MOTOR / Engine	CM ³	HP	Ø PISTON
1Y - AAZ	1896	64/75	79.50
1X	1896	61	79.50

Juego Completo de Reparación:

Jogo de Juntas do Motor / Full Set Gasket:

Semi-Juego de Reparación:

Semi-Jogo de Juntas / Semi-Set Gasket:

SJ-271**R****Juego de Descarbonización:**

Jogo de Juntas Superior / Head Set Gasket:

JD-173-ST**R**

JUNTA CULATA DE CILINDROS	TC-652 1M	Ø 81.00mm	1.50mm	±0.05	de 0,66 a 0,86mm
	TC-652 2M	Ø 81.00mm	1.60mm	±0.05	de 0,87 a 0,90mm
Junta de cabeçote	TC-652 3M	Ø 81.00mm	1.70mm	±0.05	de 0,91 a 1,02mm
Cylinder Head gasket	TC-652 4M	Ø 81.00mm	1.80mm	±0.05	de 1,03mm...

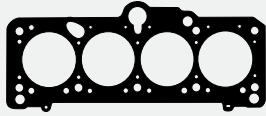

TC-652-20 1M TC-652-MG 1M
TC-652-20 2M TC-652-MG 2M
TC-652-20 3M TC-652-MG 3M
TC-652-20 4M TC-652-MG 4M
Junta Culata de Cilindros
Junta Cabeçote



JVS-279-43 - 028/103483/H
Junta Tapa Válvula Superior c/arandelas
Junta Tampa Válvula Superior c/arruelas

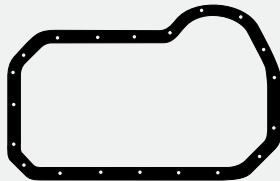

JC-314-15 - 037115220B
Junta Cártier (Cordón Sellador)
Junta Carter (Gaxeta Vedação)



1113800 - 056115441
Base filtro aceite
Base filtro óleo



1177400 - 028115441C
Filtro de aceite
Filtro de óleo



2736000 - 059121119
O'ring termostato 50 x 3,9mm



JAE-337-E - 056129589A
028129589B
Juego Escape
Jogo Escapamento



JAE-406-A - 028/129717/D
Junta Admisión
Junta Admissão



2739200 - 5949822
O'ring 36 x 3mm
Salida de agua
Saída de água



JSA-251
Salida Escape
Saída Escapamento



2743500
Buje casquillo árbol de levas
Bucha comando válvulas



1179500
Brida termostato
Flange termostato

2621400 - Juego Arandelas Metálicas/Jogo Arruelas Metálicas

Gráfico	Descripción/Descrição	Cant./Quant.
	Arandela 14x20x2mm Cobre	2
	Arandela blindada 14x18x2mm Cobre	1
	Arandela parallama 5,5x20x3,5 Acero	4
	Arandela 7x13x2,5mm Cobre	4



RT-564Pol
Juego Retenes Guía de Válvulas
Jogo Retenitor da Haste de Válvulas 7mm



RT-562Pol
Juego Ret. Guía de Válvulas
Jogo Retenitor da Haste de Válvulas 8mm



RT-8422Pol
Retén Árbol de Levas
Ret. do Eixo Comando de Válvulas
Lx-Bidi 32,00 x 47,00 x 10,00



1144800 - 059127311A
Bomba de combustible
Bomba de combustível



1113200 - 026905261A
Base distribuidor
Base distribuidor



1197100
Bomba de aceite
Bomba de óleo



1113500 - 056103181B
Bancada trasera
Virabrequiml traseira



1113600 - 056103161
Bancada delantera
Virabrequim dianteira



1113400 - 049121041B
056121041A
Bomba de agua
Bomba de água



2701700
O'ring 39 x 3mm



2737200 - 90353501/056115037
O'ring 56,4 x 1,78mm
eje intermedio
eixo intermediário



RT-6863Vit
Retén Bancada
Retenitor Traseiro do Virabrequim
Lx-R 85,00 x 105,00 x 12,00



RT-8422Pol
Retén Distribuidor
Ret. Dianteiro do Virabrequim
Lx-Bidi 32,00 x 47,00 x 10,00

Productos relacionados no incluidos en el juego. Los mismos pueden ser solicitados por separado

Produtos relacionados não incluídos no jogo. Podem ser solicitados em separado / Related products that were not included in the set but can be ordered separately.



BU-050
BU-043
Bulones para
Culata de Cilindros
Parafusos de Cabeçote



JV-177
Juego Caja Velocidad
Jogo Caixa de Câmbio



RT-9828Vit
Porta Retén Bancada
Flange Traseiro do Virabrequim
A 311-R 85,00



JC-314-43
Junta Cártier c/ Deflector
Junta Carter c/Defletor
(Sintético)



JSA-299-21
Salida Escape (Anillo Malla Acero)
Saída Escapamento
(Anel Malha Aço)



JT-121
Jgo. Turbo



JT-120
Jgo. Turbo



JAE-337-09
Juego Escape
Jogo Escapamento



2754900
Tubo Sellador Válvula Viento
Tubo vedação

Juego Completo de Reparación:

Jogo de Juntas do Motor / Full Set Gasket:

Semi-Juego de Reparación:

Semi-Jogo de Juntas / Semi-Set Gasket:

Juego de Descarbonización:

Jogo de Juntas Superior / Head Set Gasket:

JUNTA CULATA DE CILINDROS	TC-402 1M	∅ 81.00mm	1.50mm	de 0,91 a 1,00mm
	TC-402 2M	∅ 81.00mm	1.60mm	de 1,01 a 1,10mm
Junta de cabeçote	TC-402 3M	∅ 81.00mm	1.70mm	de 1,11 a 1,20mm
Cylinder Head gasket				

DESCRIPCIÓN / Descrição / Description

DIESEL**VOLKSWAGEN:** Bora - Golf SDI/TDI 1997/...**AUDI:** A3 TDI 1996/99**SKODA:** Octavia TDI 1996/...

MOTOR / Engine	CM ³	HP	∅ PISTON
ALH/AHF/AGR	1896	90/110	79.50
AGP/AHF	1896	68/110	79.50

ILLINOIS

VOLKSWAGEN

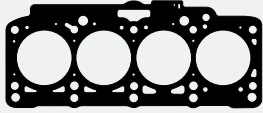

TC-402-20 1M TC-402-MG 1M - 038103383G
TC-402-20 2M TC-402-MG 2M - 038103383F
TC-402-20 3M TC-402-MG 3M - 038103383L
 Junta Culata de Cilindros
 Junta Cabeçote

JD-336-ST

JT-121-01 - 3A0253115
 Junta turbo
 Junta turbo



2754900
 Guarnición salida aceite
 Guarnição saída óleo



2760900 - 038/117070
 Junta inferior radiador
 Junta inferior radiador



JAE-406-A - 028/129717/D
 Junta Admisión
 Junta Admissão

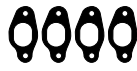

JAE-337-E - 056129589A
 028129589B/037253039D
 Juego Escape
 Jogo Escapamento



2761100
 Arandela tapa válvulas
 Arruela tampa válvula



2634000
 Arandela pico inyector
 Arruela pico injetor
 8 x 13 x 2,5mm
 (Cobre)

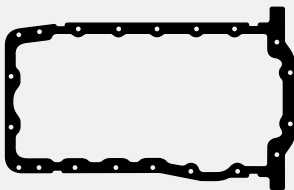

JC-382-15 - 058253039C
 Junta Cártér
 Junta Carter



1133500 - 038115441A
 Soporte filtro aceite
 Suporte filtro óleo



RT-8422Pol
 Retén Árbol de Levas
 Ret. do Eixo Comando de Válvulas
 Lx-Bidi 32,00 x 47,00 x 10,00



RT-564Pol
 Juego Ret. Guía de Válvulas
 Jogo Retentor da Haste de Válvulas



2761400
 Guarnición
 Guarnição



2700900 - N/028222/2
 O'ring 20,30 x 2,62mm



2736500
 Guarnición
 Guarnição



2761500
 Arandela 60 x 68 x 5,75mm
 Arruela (Goma/Borracha)



2756100 - N/900432/01
 O'ring 10,82 x 1,78mm



2761600 - 038/121119
 Termostato
 O'ring 57 x 4mm



2706100
 Termostato
 O'ring 50 x 4mm



2606900
 Arandela 14 x 20 x 1,5mm
 Arruela (Cobre)



1133700
 Junta Brida
 Junta Flange



RT-9911Vit
 Retén Distribución
 Retentor Dianteiro do Virabrequim
 Lx-R 35,00 x 48,00 x 10,00

Productos relacionados no incluidos en el juego. Los mismos pueden ser solicitados por separado.

Produtos relacionados não incluídos no jogo. Podem ser solicitados em separado.

Related products that were not included in the set but can be ordered separately.



JAE-337-09
 056129589A
 Juego Escape
 Jogo Escapamento

DESCRIPCIÓN / Descrição / Description

DIESEL**VOLKSWAGEN:** Amarak TDI 16V 2010/...
Crafter 30/35/50 16V 2011/...

MOTOR / Engine	CM ³	HP	Ø PISTON
CDBA	1968	122	81.00
CDCA	1968	163	81.00

Juego Completo de Reparación:

Jogo de Juntas do Motor / Full Set Gasket:

Semi-Juego de Reparación:

Semi-Jogo de Juntas / Semi-Set Gasket:

SJ-596**R****Juego de Descarbonización:**

Jogo de Juntas Superior / Head Set Gasket:

JD-596-ST**R**

JUNTA CULATA DE CILINDROS	TC-355-MG 1M	Ø 82.20mm	1.55mm	de 0,91 a 1,00mm
Junta de cabeçote	TC-355-MG 2M	Ø 82.20mm	1.65mm	de 1,01 a 1,10mm
Cylinder Head gasket	TC-355-MG 3M	Ø 82.20mm	1.75mm	de 1,11 a 1,20mm

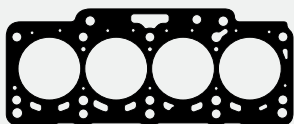

TC-355-MG 1M - 03L103383AJ/BF/BM
TC-355-MG 2M - 03L103383AK/BG/BN
TC-355-MG 3M - 03L103383AL/BH/BP
 Junta Culata de Cilindros
 Junta Cabeçote

JD-596-ST

2766000
 Arandela silicona
 Arruela silicone
 40 x 2 x 5mm



JSA-318
 Junta Salida Escape
 Junta Saída Escapamento



1188200
 Bomba de Vacío/Bomba vácuo
 03L145215A/G



2766500
 Termostato
 06B121119B



JAE-585-E
 Junta Escape CDBA
 Junta Escapamento
 03L253039H



JAE-586-E
 Junta Escape CDCA
 Junta Escapamento
 03L253039G

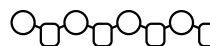

JAE-569-A
 Junta Admisión
 Junta Admissão



RT-2978Vit
 Juego Retenes
 Guia de Válvulas
 Jogo Retentor da Haste
 de Válvulas

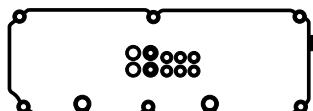

JVS-373-43
 Junta Tapa Válvula Superior
 Junta Tampa Válvula Superior
 03L103483C

2767100 - Juego Arandelas de Goma/Jogo Arruelas de Borracha

Gráfico	Descripción/Descrição	Cant./Quant.
	O'ring 136 x 3,53mm	1
	O'ring 64x3mm	1
	O'ring 57x4mm	1
	O'ring 56,8x2,62mm	1

RT-6864Pol
 Retén Árbol de Levas
 Retentor do Eixo Comando
 de Válvulas
 Lx-R 32,00 x 47,00 x 10,00



2766200
 Refrigerador aceite
 Refrigerador de óleo
 03L198070



2766300
 Soporte filtro aceite
 Suporte filtro óleo



2766400
 Soporte filtro ceite
 Suporte filtro óleo
 03L198441



2700900
 O'ring 20,30 x 2,62mm



2765900
 Arandela silicona
 Arruela silicone
 65,5 x 2 x 4,5mm



2766100
 Arandela goma
 Arruela borracha
 23 x 2,3 x 6mm



2766600
 Arandela carga de aceite
 Arruela abastecimento de óleo



RT-9911Vit
 Retén Distribución
 Ret. Dianteiro do Virabrequim
 35,00 x 48,00 x 10,00

Productos relacionados no incluidos en el juego. Los mismos pueden ser solicitados por separado.

Produtos relacionados não incluídos no jogo. Podem ser solicitados em separado.

Related products that were not included in the set but can be ordered separately.



BU-237
 Bulones p/Culata de Cilindros
 Parafusos Cabeçote



RT-3008
 Porta Retén Bancada
 Flange Traseiro do Virabrequim
 03L103171 85,00

Juego Completo de Reparación:

Jogo de Juntas do Motor / Full Set Gasket:

JR-338-15**Semi-Juego de Reparación:**

Semi-Jogo de Juntas / Semi-Set Gasket:

SJ-338**Juego de Descarbonización:**

Jogo de Juntas Superior / Head Set Gasket:

JD-338-15

JUNTA CULATA DE CILINDROS	TC-697-15	Ø 83.50mm	1.30mm	↑ ↓
Junta de cabeçote	TC-697-MG	Ø 83.50mm	1.30mm	↑ ↓
Cylinder Head gasket				↑ ↓

DESCRIPCIÓN / Descrição / Description

VOLKSWAGEN: Golf - New Beetle 2002/...
Transporter Minibus 2003/... - Caddy 2006/...
SEAT: Alhambra - Cordoba - Ibiza 2000/...

MOTOR / Engine	CM ³	HP	Ø PISTON
ATM/AZL/AEG	1984	115	82.50
APK/AQY/AZH	1984	109/115	82.50

ILLINOIS

VOLKSWAGEN

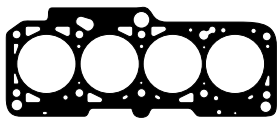
JD-338-15

TC-697-15 - 06A103383AN
Junta Culata de Cilindros
Junta Cabeçote



1139300 - 06A129717F
Junta entre colectores
Junta entre coletores



2706100 - 90118437
O'ring 50 x 4,2mm
carcasa termostato
carçaça termostato



JAE-557-E - 06A253039L
Junta Escape
Junta Escapamento



JAE-558-A - 037129717C
Junta Admisión
Junta Admissão



2714300
O'ring 47,22 x 3,53mm

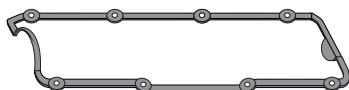

JVS-266-43 - 0291034831
Junta Tapa Válvula Superior
Junta Tampa Válvula Superior



RT-8422Pol
Retén Árbol de Levas
Ret. do Eixo Comando de Válvulas
Lx-Bidi 32,00 x 47,00 x 10,00



RT-564Pol
Juego Ret. Guía Válvulas
Jogo Retenedor da Haste de Válvulas

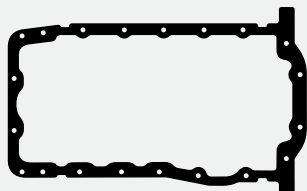

JC-382-15 - 058253039C
Junta Cártel
Junta Carter



JSA-221 - 533253155
Salida Escape
Saída Escapamento



1177400 - 028115441C
Filtro de aceite
Filtro de óleo



2761800
O'ring 53 x 3,6mm



RT-9911Vit
Retén Distribución
Retenedor Dianteiro do Virabrequim
Lx-R 35,00 x 48,00 x 10,00

Productos relacionados no incluidos en el juego. Los mismos pueden ser solicitados por separado.

Produtos relacionados não incluídos no jogo. Podem ser solicitados em separado.

Related products that were not included in the set but can be ordered separately.



BU-229
Bulones para Culata de Cilindros
Parafusos de Cabeçote



RT-9828Vit
Porta Retén Bancada
Flange Traseiro do Virabrequim
A 311-R 85,00

DESCRIPCIÓN / Descrição / Description

VOLKSWAGEN: Golf 1992/06 - Jetta - Passat - Vento - Golf Cabriolet 1999/02 - Polo 1999/... Desde Motor 031252

MOTOR / Engine	CM ³	HP	Ø PISTON
ABA/AKR/ATU	1984	115	82.50
AWF/AWG/AGG	1984	115	82.50

Juego Completo de Reparación:

Jogo de Juntas do Motor / Full Set Gasket:

JR-461-15

R

Semi-Juego de Reparación:

Semi-Jogo de Juntas / Semi-Set Gasket:

SJ-461

R

Juego de Descarbonización:

Jogo de Juntas Superior / Head Set Gasket:

JD-461-15

R

JUNTA CULATA DE CILINDROS

Junta de cabeçote

Cylinder Head gasket

TC-363-15

Ø 83.50mm

1.50mm

TC-363-MG

Ø 83.50mm

1.50mm

1.50mm

1.50mm

1.50mm

1.50mm



JD-461-15

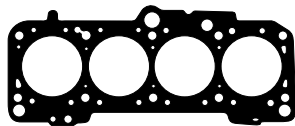

TC-363 - 037103383N
Junta Culata de Cilindros
Junta Cabeçote



JAE-558-A - 037129717C
Junta Admisión
Junta Admissão
AWF/AWG/ATU

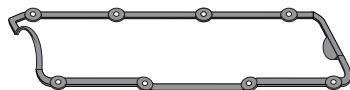

JVS-266-43 - 0291034831
Junta Tapa Válvula Superior
Junta Tampa Válvula Superior

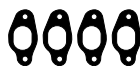

JAE-337-E
056129589A/028129589B
Junta Escape
Junta Escapamento



JAE-571-A - 026129717F
Junta Admisión
Junta Admissão



2768600
O'Ring 34,59 x 2,62mm



2712300
O'Ring 36,5 x 3,53mm



1195100 - 056103609A
Brida Termostato
Flange Termostato



RT-564Pol
Juego Retenes Guía de Válvulas
Jogo Retentor da Haste de Válvulas



RT-8422Pol
Retén Árbol de Levas
Retentor do Eixo Comando de Válvulas
Lx-Bidi 32,00 x 47,00 x 10,00

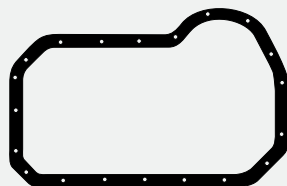

JC-278-15 - 056103609B/0491036091
Junta Cártér
Junta Carter



1113500 - 026103181B
Bancada trasera
Virabrequim traseira



1113600 - 056103161
Bancada delantera
Virabrequim dianteira



1197100
Bomba de aceite
Bomba de óleo



1177400 - 028115441C
Filtro de aceite
Filtro de óleo



JSA-221 - 533253155
Salida Escape
Saída Escapamento



1113400 - 049121041B
056121041A
Bomba de agua
Bomba de água



2706100
O'Ring 50,00 x 4,2mm
Carcasa Termostato
Carcaça Termostato



2610600 - 105452
Arandela Tapón de Carter
Arruela Tampão de Carter
14 x 20 x 1,5mm
(Aluminio)



2737200
O'Ring 56,4 x 1,78mm
Eje Intermedio
Eixe Intermediário



1114100 - 056121149
Conector
Conetor



2702700
O'Ring 28 x 3,5mm



1113200 - 026905261A
Base distribuidor
Base distribuidor



RT-6863Vit
Retén Bancada
Retentor Traseiro do Virabrequim
Lx-R 85,00 x 105,00 x 12,00



RT-8422Pol
Retén Distribución
Retentor Dianteiro do Virabrequim
Lx-Bidi 32,00 x 47,00 x 10,00

Productos relacionados no incluidos en el juego. Los mismos pueden ser solicitados por separado.

Produtos relacionados não incluídos no jogo. Podem ser solicitados em separado.

Related products that were not included in the set but can be ordered separately.



BU-042
Bulones para Culata de Cilindros
Parafusos de Cabeçote



JC-278-23
JC-278-30
Junta Cártér
Junta Carter



JC-278-43
Junta Cártér
Junta Carter
(Sintético)



JAE-572-A
19129800402
Junta Admisión
Junta Admissão



JAE-556-E
037253039D
Junta Escape
Junta Escapamento

Juego Completo de Reparación:

Jogo de Juntas do Motor / Full Set Gasket:

JR-769-15

DESCRIPCIÓN / Descrição / Description

VOLKSWAGEN: Golf - New Beetle -
Transporter Minibus - Caddy
SEAT: Alhambra - Cordoba - Ibiza**Semi-Juego de Reparación:**

Semi-Jogo de Juntas / Semi-Set Gasket:

SJ-769**Juego de Descarbonización:**

Jogo de Juntas Superior / Head Set Gasket:

JD-769-15

JUNTA CULATA DE CILINDROS	TC-697-15	∅ 83.50mm	1.30mm	∅
Junta de cabeçote	TC-697-MG	∅ 83.50mm	1.30mm	∅
Cylinder Head gasket				

MOTOR / Engine	CM ³	HP	∅ PISTON
AZG/AEG/AXA/BBX	1984	115	82.50
BEH/BER	1984	116	82.50
BSX	1984	109	82.50

ILLINOIS

VOLKSWAGEN

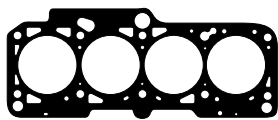
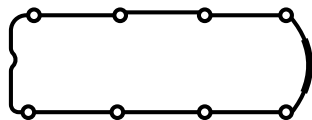
JD-769-15**TC-697-15 - 06A103383AN**
Junta Culata de Cilindros
Junta Cabeçote**1139300 - 06A129717F**
Junta entre colectores
Junta entre coletes**2714300**
O'ring 47,22 x 3,53mm**JAE-557-E - 06A253039L**
Junta Escape
Junta Escapamento**JAE-558-A - 037129717C**
Junta Admisión
Junta Admissão**JAE-559-A - 06A129717A**
Juego Admisión
Jogo Admissão**JVS-406-43 -**
Junta Tapa Válvula Superior
Junta Tampa Válvula Superior**2706100 - 90118437**
O'ring 50 x 4,2mm
carcasa termostato
carcaça termostato**RT-8422Pol**
Retén Árbol de Levas
Retenedor do Eixo Comando
de Válvulas
Lx-Bidi 32,00 x 47,00 x 10,00**JC-382-15 - 058253039C**
Junta Cáster
Junta Carter**1177400 - 028115441C**
Filtro de aceite
Filtro de óleo**RT-564Pol**
Juego Ret. Guía Válvulas
Jogo Retenedor da Haste
de Válvulas**2761800**
O'ring 53 x 3,6mm**JSA-221 - 533253155**
Salida Escape
Saída Escapamento**RT-9911Vit**
Retén Distribución
Retenedor Dianteiro do
Virabrequim
Lx-R 35,00 x 48,00 x 10,00

Productos relacionados no incluidos en el juego. Los mismos pueden ser solicitados por separado.

Produtos relacionados não incluídos no jogo. Podem ser solicitados em separado.

Related products that were not included in the set but can be ordered separately.

DESCRIPCIÓN / Descrição / Description

VOLKSWAGEN: Gol 1995/2000 - Golf 1992/97
Passat 1994/96 - Parati 1996/2000

MOTOR / Engine	CM ³	HP	Ø PISTON
ABF 16V	1985	150	82.50

Juego Completo de Reparación:

Jogo de Juntas do Motor / Full Set Gasket:

JR-751-15**R****Semi-Juego de Reparación:**

Semi-Jogo de Juntas / Semi-Set Gasket:

SJ-751**R****Juego de Descarbonización:**

Jogo de Juntas Superior / Head Set Gasket:

JD-751-15**R****JUNTA CULATA DE****CILINDROS**

Junta de cabeçote

Cylinder Head gasket

TC-600-15

Ø 83.50mm

1.60mm

TC-600-18

Ø 83.50mm

2.30mm

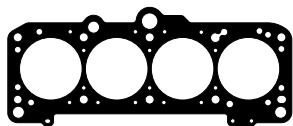
**JD-751-15**

TC-600-15 - 0531033834
Junta Culata de Cilindros
Junta Cabeçote



2737200 - 90353501/056115037
O'ring 56,4 x 1,78mm
eje intermedio
eixo intermediário



2736000 - 059121119
O'ring termostato 50 x 3,9mm



1179500
Brida termostato
Flange termostato



JAE-638-A - 027129717C
Junta Admisión
Junta Admissão



JAE-639-E - 027129589A
Juego Escape
Jogo Escapamento



2736400
O'ring 35,3 x 3mm
conexión TC a calefactor
conexão TC a aquecedor



2736600
Conducto admisión
Conduto admissão

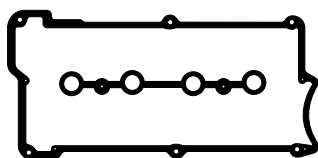

JVS-417-43 - 051198025
Junta Tapa Válvula Superior
Junta Tampa Válvula Superior



JSA-221 - 533253155
Salida Escape
Saída Escapamento



RT-590Pol
Juego Retenes Guía de Válvulas
Jogo Retentor da Haste
de Válvulas



RT-8422Pol
Retén Árbol de Levas
Ret. do Eixo Comando de Válvulas
Lx-Bidi 32,00 x 47,00 x 10,00



JC-314-15 - 037115220B
Junta Cártier (Cordón Sellador)
Junta Carter (Cordão Vedação)



1113500 - 056103181B
Bancada trasera
Virabrequim traseira



1113600 - 056103161
Bancada delantera
Virabrequim dianteira



1113400 - 049121041B
056121041A
Bomba de agua
Bomba de água



1197100
Bomba de aceite
Bomba de óleo



1113800 - 056115441
Base filtro aceite
Base filtro óleo



1113200 - 026905261A
Base distribuidor
Base distribuidor



2739200 - 5949822
O'ring 36 x 3mm
Salida de agua
Saída de água



RT-6863Vit
Retén Bancada
Retentor Traseiro do Virabrequim
Lx-R 85,00 x 105,00 x 12,00



RT-8422Pol
Retén Distribución
Ret. Dianteiro do Virabrequim
Lx-Bidi 32,00 x 47,00 x 10,00

Productos relacionados no incluidos en el juego. Los mismos pueden ser solicitados por separado.

Produtos relacionados não incluídos no jogo. Podem ser solicitados em separado.

Related products that were not included in the set but can be ordered separately.

Juego Completo de Reparación:

Jogo de Juntas do Motor / Full Set Gasket:

JR-752-07

DESCRIPCIÓN / Descrição / Description

VOLKSWAGEN: Jetta 2005/07 - Bora 2005/07
Golf 2007/... - New Beetle 2005/07
Vento 2005/...

MOTOR / Engine	CM ³	HP	Ø PISTON
CBTA/CBUA/CCCA 20V	2480	170	82.50
BTK 20V	2480	150	82.50
BPR/BPS 20V	2480	150	82.50
BGP/DBQ 20V	2480	150	82.50

ILLINOIS

VOLKSWAGEN

Semi-Juego de Reparación:

Semi-Jogo de Juntas / Semi-Set Gasket:

Juego de Descarbonización:

Jogo de Juntas Superior / Head Set Gasket:

JUNTA CULATA DE CILINDROS	TC-953-07	Ø 83.00mm	1.60mm	↕
Junta de cabeçote	TC-953-11	Ø 83.00mm	1.10mm	↕
Cylinder Head gasket				↕

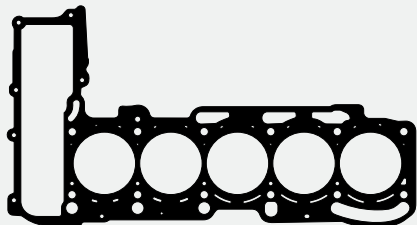
**TC-953-07 - 07K103383F**
Junta Culata de Cilindros
Junta Cabeçote

Junta

Salida escape
Saída EscapamentoJuego Admisión
Jogo AdmissãoJunta Escape
Junta Escapamento

Junta

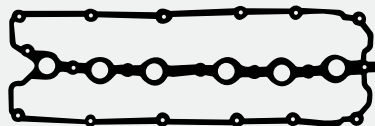
Junta Tapa Válvula Superior
Junta Tampa Válvula SuperiorJuego Retenes Guía de Válvulas
Jogo Retentor da Haste de Válvulas**RT-6863Vit**
Retén Bancada
Retentor Traseiro do Virabrequim
Lx-R 85,00 x 105,00 x 12,00

Productos relacionados no incluidos en el juego. Los mismos pueden ser solicitados por separado.

Produtos relacionados não incluídos no jogo. Podem ser solicitados em separado.

Related products that were not included in the set but can be ordered separately.

ILLINOIS®

JUNTAS
CULATA DE CILINDROS
MODELOS NO INCLUIDOS EN LOS JUEGOS COMPLETOS DE REPARACIÓN

ESP

JUNTAS
DE CABEÇOTE
MODELOS NÃO INCLUIDOS NOS JOGOS DE JUNTAS DO MOTOR

PORT

CYLINDER HEAD
GASKET

MODELS NOT INCLUDED IN FULL SET GASKETS

ENG

TTC

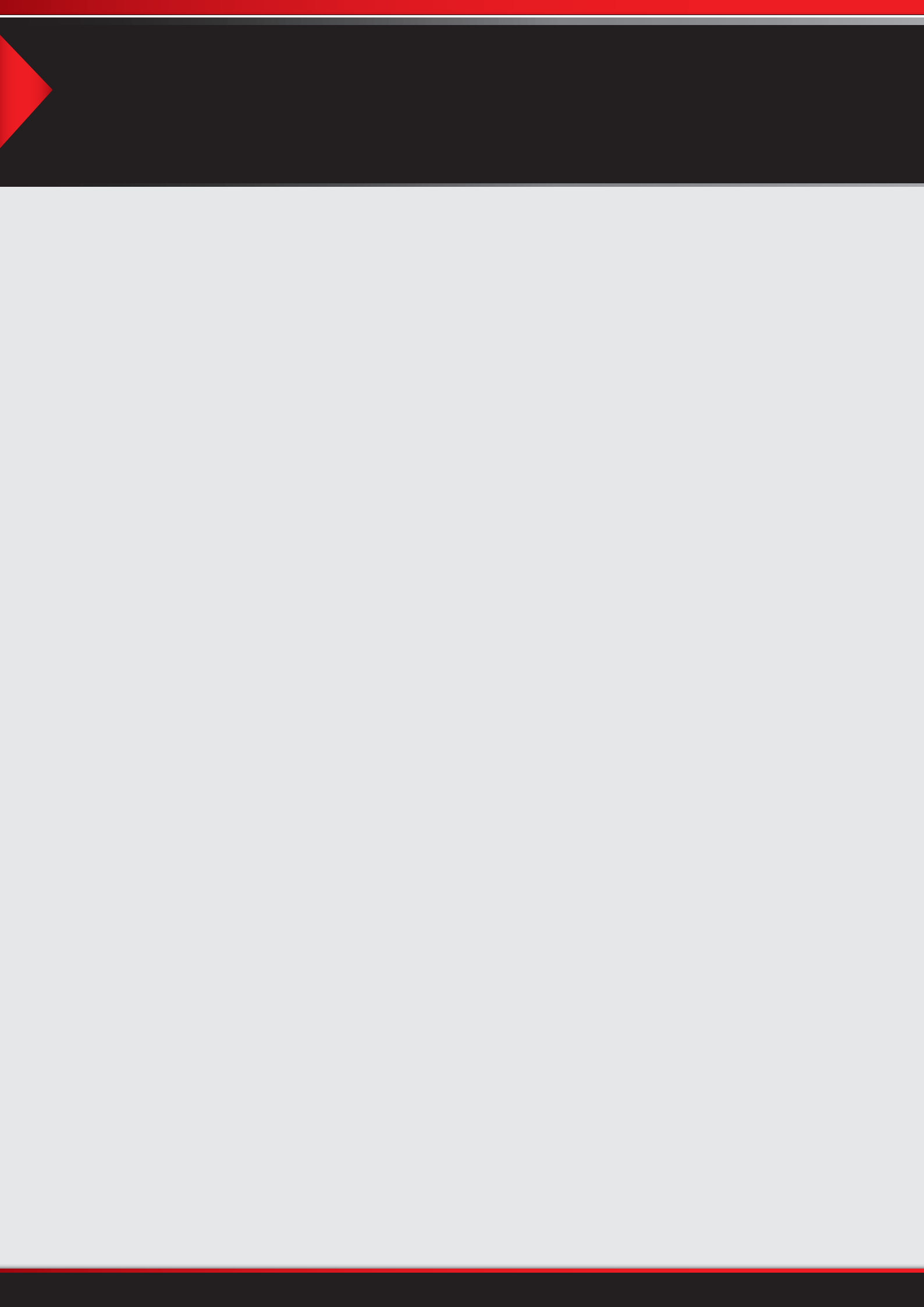

JUNTAS CULATA DE CILINDROS (TC) Junta de Cabeçote / Cylinder Head Gasket

Ordenado por cm³ / Ordenados pelo cm³
Arranged by cm³

ACURA							
REF.	MODELO / MODEL		Cm ³	MOTOR / ENGINE	HP	Ø Pist.	PAG.
TC-350-11	EL - OH 1622 2000/... - HONDA: ACCORD - CITY 1999/03 - CIVIC/VTEC/VTEC-E 1992/00 - CRX VTEC 1992/98 - HRV 1999/05 - ROVER: 216 - 416 1992/94 -		1342cc.	D13B6/7/8	95/65	75.00	403
			1396cc.	D14A/Z	75/90	75.00	
			1493cc.	D15Z	101/114	75.00	
			1590cc.	D16B/W/Y/Z	105/125	75.00	
TC-383-11	ACURA: RSX 2002/06 - HONDA: ACCORD - CIVIC VI/VII VTEC 16V 2003/... CRV 2002/... - INTEGRA - STEPWAGON 2000/05 - STREAM 2001/... (12251PNA004/12251PNC004/12251PPA004)		1998cc.	K20A1/3/4/5/9	150/155/160	86.00	404
			2350cc.	K24A1	170/200	86.00	

ALFA ROMEO							
REF.	MODELO / MODEL		Cm ³	MOTOR / ENGINE	HP	Ø Pist.	PAG.
TC-761-15	145/146/155/156 TWIN SPARK 16V 1996/...		1598cc.	676.01	120	82.00	399
			1747cc.	671.06/671.99/322.01	140/144	82.00	

ASIA							
REF.	MODELO / MODEL		Cm ³	MOTOR / ENGINE	HP	Ø Pist.	PAG.
TC-496-15	ROCSTA 1994/... - FORD: PROBE 1989/92 - KIA: SPORTAGE 1995/99 MAZDA: CAPELLA - 626 - 929 - E1800 - E2000 - B2000 - FORKLIFT B2200 MX6 - TELSTER 1982/... (F20210271) (F80110271)		1789cc.	F8	83	86.00	406
			1998cc.	FE	83	86.00	
			2184cc.	F2 - F2L	147	86.00	
TC-812-15	ROCSTA - FORD: RANGER - PROBE/TURBO - KIA: SPORTAGE MAZDA: CAPELLA - B2200 - E1800 87/... - E2200 99/... - 929 - 626 MX6/TURBO 12V		1789cc.	F8	83	86.00	407
			1998cc.	FE	82/109	86.00	
			2184cc.	F2	147	86.00	
TC-120-20	ROCSTA - KIA: BESTA - BONGO - CERES .../1987 - MAZDA: E2000 - 626 CAPELLA E/B2200 (OK77010271/R20210271/R20110271A/D/E)	Diesel	1998cc.	RF CX	65/75/82	86.00	407
			2184cc.	HW R2	64/72	86.00	

BMW							
REF.	MODELO / MODEL		Cm ³	MOTOR / ENGINE	HP	Ø Pist.	PAG.
TC-519-06	316(E21) - 315 - 318 - 518 - 320 - 520 1963/82 4CIL. (11129065653/11121734279)		1573cc.	M10 B16/B18	85/90/98	84.00	399
			1773cc.			89.00	
TC-507-06	320/I - 520/I - 323I (E21) 1977/93 6CIL. (11121722725)		1990cc.	M20	122	80.00	399
			2315cc.	B20/B23	150	80.00	
TC-508-06	323 - 523 - 325 - 525 - 328 - 528 24V 1989/96 6CIL. (11121726617)		2494cc.	M50 B25	192	84.00	399
TC-556-07	535 - 635 6 CIL. (BOCA CHICA)						399

CHEVROLET / OPEL							
REF.	MODELO / MODEL		Cm ³	MOTOR / ENGINE	HP	Ø Pist.	PAG.
TC-729-15	SPRINT 1989/... - SUZUKI: SWIFT INY. - CULTUS 1988/... (1114160301)		993cc.	G10A - 61	55		399
TC-882-20 TC-882-MG	COMBO - AGILA - CORSA - ASTRA - TIGRA TD 2000/... MERIVA 2003/... FIAT: DOBLO - SIENA - IDEA - PANDA - PUNTO - GRANDE PUNTO JTD 16V 2002/... - LANCIA: MUSA 2004/...	Diesel	1248cc.	Z13DT - Y13DT 199A.3000/2000 188A.9000	69/90	69.60	399
TC-467-15	LUV - RODEO - 117 COUPE - FLORIAN 1975/87 - CAMPO - ISUZU: GEMINI FASTER (8942104410)(8942118650) (8942168690/8700)		1584cc.	G161Z	100	82.00	399
			1817cc.	G180Z	100	84.00	
TC-731-07	FARGO - WFR 11DV - ASKA - SHUTTLE 1982/... (8941653240)		1817cc.	4ZB1	97/105	84.00	399
TC-130-20 TC-130-MG	LUV - FARGO - ASKA - OPEL MIDI 1980/... ISUZU: I-MARK GEMINI (8942350600)(8842480270)(8941166570)	Diesel	1817cc.	4FB1	61	84.00	399
			1995cc.	4FC1	66	84.00	
TC-924-11	CAPTIVA 4WD - CRUZE CDI 16V (25190137/8/9/4818004/5/6)	Diesel	1998cc.	LNP	150	86.00	400
			1998cc.	Z20D1	131	86.00	
			2231cc.	Z22D1	163	86.00	
TC-391-07	CAMPO - PICK UP LUV S10/15 1984/85 - PICK UP LUV S11/12 1981/82 ISUZU: FASTER - PICK UP 1981/84 - JEEP 1982/... (5111410671/5111410821/ 94030188)	Diesel	2237cc.	C223	73	88.00	405
TC-806-11	ASTRA ELITE - ZAFIRA ELITE - VECTRA ELITE - BLAZER - S10 8V/16V (MLS)		2405cc.	MPFI - X24SFD OHC	128/142	86.00	400
TC-113-09	CHEVROLET J6 1956/61 BEDFORD	Diesel	4927cc.	300 D	97	98.30	400
TC-147-05	6 CIL. 1929/33						400

CHRYSLER							
REF.	MODELO / MODEL		Cm ³	MOTOR / ENGINE	HP	Ø Pist.	PAG.
TC-472-07	ARROW - CHALLENGER - COLT - CHAMP - MITSUBISHI: L200 - LANCER SAPPORO GALANT - CELESTE - LAMBA - SIGMA 1978/... (MD007515/8766/9451)		1597cc.	4G32-G32B	86/100	77.00	407
TC-493-20 TC-493-MG	DAKOTA TD - GRAND VOYAGER TD 1995/... - FORD: SCORPIO TDCI SCC/SCD JEEP: CHEROKEE - GRAND CHEROKEE	Diesel	2499cc.	VM425	114/121	92.00	400
			2499cc.	VM41B - SCC/SCD	115/125	92.00	

CHRYSLER - Continuación...						
REF.	MODELO / MODEL		Cm ³	MOTOR / ENGINE	HP	Ø Pist. PAG.
TC-811-15	LEBARON - RAIDER - NEW YORKER - CARAVELLE - RAM 50 - COUNTRY VOYAGER - CARAVAN - 400 - 600 1981/89 - MITSUBISHI: SAPPORO - SHOGUN SIGMA - MONTERO - S - SP - SPX - PAJERO - L200 1983/97 - STARION 1983/... MAZDA: B2600 1987/94 (MD026654/MD110383)		2555cc.	G54B - 4G54 4G54B - AM	103/155	91.10 408
TC-655-20	DAKOTA TD - CARAVAN - JEEP: CHEROKEE - GRAND CHEROKEE 1999/...	<i>Diesel</i>	3100cc. 3125cc.	VM 531 TD EXA	142 140	92.00 92.00 400
TC-486-15	DAKOTA - PICK UP 1996/... - RAM 1500		3906cc.	239CID V6 OHV	130	99.30 400
TC-689-15	CHEROKEE - GRAND CHEROKEE - SPORT - COMANCHE - WAGONNER WRANGLER 1986/2001		3960cc.	240 - 242/L	185	98.40 400

CIMARRON						
REF.	MODELO / MODEL		Cm ³	MOTOR / ENGINE	HP	Ø Pist. PAG.
TC-451-20	3300 DE 1976/85	<i>Diesel</i>	3285cc.	3300D	88	98.30 400
TC-458-06	3300 MODELO NUEVO 1986/...	<i>Diesel</i>	3283cc.	3300D	89	98.42 400
TC-449-06	3800 DE 1979/85	<i>Diesel</i>	3840cc.	3800D	99	106.40 401
TC-640-06	3800 MODELO NUEVO 1986/...	<i>Diesel</i>	3840cc.	3800D	99	106.40 401

DAEWOO						
REF.	MODELO / MODEL		Cm ³	MOTOR / ENGINE	HP	Ø Pist. PAG.
TC-732-15	TICO - SUZUKI: ALTO 3CIL. 1980/... (1114178400/440)		796cc.	F8 - F8B - AB51	41	68.50 401
TC-106-15	NEXIA - CIELO - ESPERO 1994/97 - KALOS 2002/... (96181216)		1399cc. 1498cc.	G15MF - F14S3	83 75	77.90 76.50 401

DAIHATSU						
REF.	MODELO / MODEL		Cm ³	MOTOR / ENGINE	HP	Ø Pist. PAG.
TC-447-06	55 WIDE CAB - MAX CUORE - HI JET - CAB VAN - L40 - S10 - S60 FELLOW 1977/... (1111587701/03)		547cc.	AB		71.60 401
TC-582-06	CUORE - DOMINO - MIRA - MOVE - MAX CUORE 1986/... (1111587208)		846cc.	ED - ED20	41	66.60 401
TC-111-06	CHARADE TURBO 12V GTTI 1987/93 (1111587724)		993cc.	CB80T	101	76.00 401
TC-613-15	CHARADE - HI JET 1983/... - S70 - S75 - G100 - G10 - G11 (1111587702/05/10/14/24/29)		993cc.	CB-CB10/20/22/23 CB51/90/41/42	45/50/52 68/54/45/48	76.00 401
TC-843-07	CHARADE G30 1983/87 3CIL. (1111587713/19/20)	<i>Diesel</i>	993cc.	CL10	38	76.00 401
TC-847-07	CHARMANT 1975/77 - TOYOTA: COROLLA - STARLET - PUBLICA 1967/77 KE30/40/45/60 - SPRINTER (11111524013)		1077cc. 1166cc.	3K-H/3K-U/3K-J K-3KC	64/68	75.00 75.00 411
TC-477-07	CHARMANT - CONSORTE - TOYOTA: COROLLA - STARLET - LITEACE SPRINTER - TOWNACE 1977/... (1111513030/31)		1166cc. 1290cc.	3K/U/J-4K-4KU	64 74	75.00 75.00 411
TC-345-11	SIRION - MINISTAR 2000/05 - TERIOS - YRV - TOWNER 2000/05 TOYOTA: BELTA - YARIS 2002/...		1298cc. 1298cc.	2SZ-FE 16V K3-VE/VET 16V	87 84/102/140	72.00 72.00 411
TC-344-11	MATERIA - PRISMA 2006/... - SIRION - MINISTAR 2008/... - TERIOS 2005/... TOYOTA: AVANZA - AVANZADA 2006/... - RUSH 2008/09		1298cc. 1495cc.	K3-VE 3SZ-VE	90 103/105/109	72.00 72.00 411
TC-850-07	CHARMANT 1981/83 - TOYOTA: COROLLA - CARINA - TERCEL CORSA 1978/83 SPRINTER (1111515020/30/41)		1452cc.	1A-3A-1AU-3AU	80	77.50 412
TC-851-07	DELTA WIDE 1990/... - TOYOTA: COROLLA - LITEACE KE74A 1984/... (1111513040)		1486cc.	5K-J/5K-U	68	80.50 412
TC-478-07	CHARMANT - DELTA WIDE 1970/82 - TOYOTA: CARINA - GELICA - CAMRY TOWNACE - COROLLA - SPRINTER - CORONA 1970/82 (1111526031)		1588cc. 1778cc.	2T-2TJ-3T-12TU 13T	100 105	85.00 85.00 412
TC-846-07	DELTA 1972/75 - TAFT 1976/81 - TOYOTA: CORONA - HILUX - HIACE RN20 - TOYOACE 1971/75 - TOWNACE 1976/... (1111531020)		1588cc.	12R/R-J/R-U	80/83	80.50 412
TC-554-20 TC-554-MG	DELTA WIDE 1982/88 - TOYOTA: COROLLA - TOWNACE - CARINA (1111564010/20)	<i>Diesel</i>	1839cc.	1C	64	83.00 413

DATSUN						
REF.	MODELO / MODEL		Cm ³	MOTOR / ENGINE	HP	Ø Pist. PAG.
TC-541-06	CEDRIC - PICKUP 720 - CABALL - CABSTAR - CLIPPER - HOMER - JUNIOR CIVILIAN - CARAVAN - GLORIA 1970/... (11044Y1400/01)	<i>Diesel</i>	1991cc. 2164cc.	SD20 SD22	60 65	83.00 83.00 402
TC-861-07	FORKLIFT - D21 1983/92 - VANETTE - URVAN 1987/... - NISSAN: TRUCK 2400 PATHFINDER - TERRANO - PICK UP 1983/92 (104410W01/02)		2187cc. 2389cc.	Z22E/S Z24S/I	103	87.00 89.00 401

DIAR						
REF.	MODELO / MODEL		Cm ³	MOTOR / ENGINE	HP	Ø Pist. PAG.
TC-559-01	1 CIL. MOTOR ESTACIONARIO					402
TC-548-01	1 CIL. MOTOR ESTACIONARIO					402

DODGE						
REF.	MODELO / MODEL		Cm ³	MOTOR / ENGINE	HP	Ø Pist. PAG.
TC-845-15	CHEROKEE - JEEP: CHEROKEE CJ/DJ/YJ - PICK UP 1981/86 WRANGLER 1986/90		4200cc.	258 AMC CHEROKEE		95.30 402
TC-944-07	GRAND CHEROKEE - LIBERTY 2002/... - DODGE: DAKOTA - RAM 2500 2002/... (53020673AC)		4701cc. 4701cc.	EVA V8 16V EVC V8 16V	235 235	93.00 93.00 405



FIAT						
REF.	MODELO / MODEL		Cm ³	MOTOR / ENGINE	HP	Ø Pist. PAG.
TC-791-15 TC-791-MG	MOBI - ARGO - UNO WAY 2017/... (55267849)		999cc.	FIREFLY GSE N3	71	70.00 402
TC-882-20 TC-882-MG	DOBLO - SIENA - IDEA - PANDA - PUNTO - GRANDE PUNTO JTD 16V 2002/... CHEVROLET: COMBO - AGILA - CORSA - ASTRA - TIGRA TD 2000/... MERIVA 2003/... - LANCIA: MUSA 2004/...	<i>Diesel</i>	1248cc.	Z13DT - Y13DT 199A.3000/2000 188A.9000	69/90	69.60 399

FORD						
REF.	MODELO / MODEL		Cm ³	MOTOR / ENGINE	HP	Ø Pist. PAG.
TC-623-15	FIESTA I/XR2 - ESCORT/XR3I - ORION TURBO 1980/... (92SM6051BA)		1296cc. 1597cc.	CVH(HL) (HL16CF/EFI)	60 108	80.00 80.00 402
TC-735-07	LASER - FESTIVA - KIA: PRIDE 91/... - MAZDA: 323 - 121 - FAMILIA (KVO310271/B30110271)		1323cc.	OHC / B3	59/67	71.00 406
TC-844-07	FESTIVA 1988/93 - KIA: PRIDE 1991/93 - MAZDA: FAMILIA - 323 - 121 1987/91 (B30210271)		1323cc.	B3 DOHC	60/66	71.00 406
TC-647-15	FIESTA - ESCORT 1986/98 - ORION 1986/94		1392cc.	HL14G - CFI - EFI	73/75	77.20 402
TC-737-07	TRACER - MERCURY - MAZDA: 323 - FAMILIA - LASER - ETUDE 1987/... (B63010271/A/C/B61610271)		1498cc. 1597cc.	B5 B6	72 101/105	78.00 78.00 406
TC-956-15 TC-956-MG	FOCUS - FIESTA 1998/... (1097083/1253985/ 3S4G6051CA/ C60110271/YS4G6051CA)		1596cc.	ZETEC SE 16V	101/103	79.00 402
TC-496-15	PROBE 1989/92 - ASIA: ROCSTA 1994/... - KIA: SPORTAGE 1995/99 MAZDA: CAPELLA - 626 - 929 - E1800 - E2000 - B2000 - FORKLIFT B2200 MX6 - TELSTER 1982/... (F20210271) (F80110271)		1789cc. 1998cc. 2184cc.	F8 FE F2 - F2L	83 83 147	86.00 86.00 86.00 406
TC-812-15	RANGER - PROBE/TURBO - ASIA: ROCSTA - KIA: SPORTAGE MAZDA: CAPELLA - B2200 - E1800 87/... - E2200 99/... - 929 - 626 MX6/TURBO 12V		1789cc. 1998cc. 2184cc.	F8 FE F2	83 82/109 147	86.00 86.00 86.00 407
TC-495-07	COURIER 1979/82 - MAZDA: 121 - 626 - 616 - 929 - B2000 - COSMO CAPELLA - LUCE 1973/84 (045310271/A)		1769cc. 1970cc.	MA-VC	100 110	80.00 80.00 406
TC-324-11	CMAX - FOCUS 2006/... - MONDEO 2000/... - MAZDA: 6 - VOLVO: C30 - S40 V50 2005/... 16V		1798cc. 1798cc. 1798cc.	CGBA/CGBB/CHBA/CHBB CSDA/B QQDA/B Q7DA/B4184S8/11/L8	110/125 120/125 125/115/120	83.00 83.00 83.00 402
TC-119-06	ESCORT - TEMPO - ECONOVAN 1984/... - MAZDA: CAPELLA - 626 1982/94 (RF0310271)	<i>Diesel</i>	1998cc.	RF/D2	56/64	86.00 407
TC-860-15	FOCUS 2016/... (5185441/CM5E6051DF/CP9Z6051D)		1999cc.	MGDA / XQDA	170 / 150	87.50 402
TC-493-20 TC-493-MG	SCORPIO TDCI SCC/SCD - CHRYSLER: DAKOTA TD - GRAND VOYAGER TD 1995/... - JEEP: CHEROKEE - GRAND CHEROKEE	<i>Diesel</i>	2499cc. 2499cc.	VM425 VM41B -SCC/SCD	114/121 115/125	92.00 92.00 400
TC-698-07	EXPLORER - RANGER - NAVAJO - BRONCO II - AEROSTAR 1990/... (IZQUIERDA) (95TM6083AA)	<i>Diesel</i>	3996cc.	244CID V6 SOHC 12V	147/165	100.40 403
TC-699-07	EXPLORER - RANGER - NAVAJO - BRONCO II - AEROSTAR 1990/... (DERECHA) (95TM6051AA)	<i>Diesel</i>	3996cc.	244CID V6 SOHC 12V	147/165	100.40 403
TC-439-06	RANGER 100 1989/... - GALAXY - MAVERICK V8 1976/97		4942cc.	F302 V8		101.60 403
TC-236-01	FORD 1932/37					403

HAN JIAG						
REF.	MODELO / MODEL		Cm ³	MOTOR / ENGINE	HP	Ø Pist. PAG.
TC-108-06	HAN JIAG 4 CIL.					403

HONDA						
REF.	MODELO / MODEL		Cm ³	MOTOR / ENGINE	HP	Ø Pist. PAG.
TC-560-06	ACY 550 TA TB TN 1978/... - CIVIC 2 CIL. (12251679004)		545cc.	EH		403
TC-837-07	CIVIC COUPE/SI - BALLADE CRX - ROVER: 213 1984/89 (12251PE0003)		1200cc. 1342cc. 1488cc.	EW1-EW2-EW3 EW4-EV-EV1 EV2	80 100	74.00 74.00 74.00 403
TC-826-07	FIT I (AA) 1983/86 - JAZZ I (AA) - CITY BOX/HATCHBACK (12251PC0010)		1231cc. 1231cc. 1231cc.	ER1 ER2 ER4	56 45 54	61.90 61.90 61.90 403
TC-350-11	ACCORD - CITY 1999/03 - CIVIC/VTEC/VTEC-E 1992/00 - CRX VTEC 1992/98 HRV 1999/05 - ACURA: EL - OH 1622 2000/... - ROVER: 216 - 416 1992/94		1342cc. 1396cc. 1493cc. 1590cc.	D13B6/7/8 D14A/Z D15Z D16B/W/Y/Z	95/65 75/90 101/114 105/125	75.00 75.00 75.00 75.00 403
TC-517-07	ACCORD - PRELUDE 1978/83 - VIGOR 1982/83 - QUINTET 1981/... (12251689010/12251PB2000/689010)		1599cc. 1602cc. 1750cc.	EL EP EL/EK	82 90 95/97	77.00 77.00 77.00 403
TC-383-11	ACCORD - CIVIC VI/VII VTEC 16V 2003/... - CRV 2002/... - INTEGRA STEPWAGON 2000/05 - STREAM 2001/... - ACURA: RSX 2002/06 (12251PNA004/12251PNC004/12251PPA004)		1998cc. 2350cc.	K20A1/3/4/5/9 K24A1	150/155/160 170/200	86.00 86.00 404

HYUNDAI							
REF.	MODELO / MODEL		Cm ³	MOTOR / ENGINE	HP	Ø Pist.	PAG.
TC-940-07	HB20 - PICANTO		998cc.	KAPPA CVVT 12V	75/80	71.00	404
TC-485-06	PONY 1983/85 - MITSUBISHI : COLT - LANCER - MIRAGE 1977/... (MD030290)		1244cc. 1298cc.	G11B G4AG	72 87	69.50 69.50	407
TC-781-15	PONY - ACCENT - SCOUPE - GETZ - ELANTRA 1994/... (2231122120/22130)		1341cc. 1495cc.	G4K - G4N - G4EH G4EK-GAEK 50HC 12V	60/84 65/67	71.50 75.50	404
TC-482-15	EXCEL - PONY 1985/86 - MIRAGE - TREDIA - LANTRA - MITSUBISHI : COLT 1979/82 SOHC - LANCER - CORDIA 1978/86 - CHRYSLER : CHAMP (MD030293)(2231121010/100)		1410cc. 1468cc.	G12B/T - G4AJ G4J	80/105 74/84	74.00 75.50	407
TC-958-15	NEW ACCENT - GETZ - LANTRA - KIA : RIO (2231126101)		1599cc. 1599cc. 1599cc.	G4ED G4ED-G G4ED-L	104 103 90	76.50 76.50 76.50	404
TC-351-11	LANTRA - ELANTRA 1996/00 - COUPE 1997/00 (2231123100)		1599cc.	G4DR	84/114	77.40	404
TC-321-11	SONATA - KIA : MAGENTIS - OPTIMA/EX/LX/SE 2001/06 (2231138200/2231138C00)		2350cc. 2350cc.	G4JS 16V SIRIUS II 16V	136/149	86.50 86.50	404
TC-814-20 TC-814-MG	H1 2002/... - KIA : SORENTO CRDI (223114A010)		2497cc.	D4CB 16V	110/140	91.00	405
TC-329-11	TUCSON GL/GLS/LX/SE 2005/11 - COUPE - SANTA FE 2001/06 - SONATA TIBURON - TRAJET 2000/09 - KIA : MAGENTIS - OPTIMA 2004/06 SPORTAGE 2004/10 (2231137320) (DERECHA)		2600cc. 2600cc.	G6BA V6 24V G6BA-C V6 24V	165/170/175 165	86.70 86.70	404
TC-330-11	TUCSON GL/GLS/LX/SE 2005/11 - COUPE - SANTA FE 2001/06 - SONATA TIBURON - TRAJET 2000/09 - KIA : MAGENTIS - OPTIMA 2004/06 SPORTAGE 2004/10 (2231137310) (IZQUIERDA)		2600cc. 2600cc.	G6BA V6 24V G6BA-C V6 24V	165/170/175 165	86.70 86.70	404

INDENOR							
REF.	MODELO / MODEL		Cm ³	MOTOR / ENGINE	HP	Ø Pist.	PAG.
TC-564-06	6 CIL. PICK UP - CAMIONES LIVIANOS 1976/... (7932564965)	<i>Diesel</i>	3168cc.	XDP 6.90	95	90.00	404

ISUZU							
REF.	MODELO / MODEL		Cm ³	MOTOR / ENGINE	HP	Ø Pist.	PAG.
TC-865-07	TRUCK - LV 12V 1988/... - NISSAN : SUNNY - PULSAR 12V 1988/... (110487A00)		1392cc. 1497cc.	GA14S GA15E	79 97	73.60 73.60	408
TC-602-20 TC-602-MG	I-MARK - GEMINI 1985/... - OPEL : CORSA A/B - KADETTE 1984/99 (8943864430) (8941501940/2) (8944716200/1)	<i>Diesel</i>	1468cc. 1487cc.	4EC1 - T4EC1 15D/T - X15D/T	50 76	76.00 76.00	404
TC-467-15	GEMINI - FASTER - CHEVROLET : LUV - RODEO - 117 COUPE - FLORIAN 1975/87 CAMPO (8942104410)(8942118650)(8942168690/8700)		1584cc. 1817cc.	G161Z G180Z	100 100	82.00 84.00	399
TC-129-15	FARGO - TFR - TFS - WFR 1981/... (8942320971/8970417670)		1584cc.	4ZA1	75	82.00	405
TC-731-07	FARGO - WFR 11DV - ASKA - SHUTTLE 1982/... (8941653240)		1817cc.	4ZB1	97/105	84.00	399
TC-130-20 TC-130-MG	I-MARK - GEMINI - CHEVROLET : LUV - FARGO - ASKA - OPEL MIDI 1980/... (8942350600)(8842480270)(8941166570)	<i>Diesel</i>	1817cc. 1995cc.	4FB1 4FC1	61 66	84.00 84.00	399
TC-569-07	ELF 150/250 - PICK UP - FASTER - FLORIAN - TRACTOR 1968/... (5111410172)	<i>Diesel</i>	1951cc. 2369cc.	C190 C240	62 92	86.00 86.00	405
TC-866-07	FARGO 2200 WFS 1987/... (8941248800)	<i>Diesel</i>	2189cc. 2380cc.	AFD1 4FG1	61 74	88.00 88.00	405
TC-391-07	FASTER - PICK UP 1981/84 - JEEP 1982/... - CHEVROLET : CAMPO - PICK UP LUV S10/15 1984/85 - PICK UP LUV S11/12 1981/82 (5111410671/5111410821/ 94030188)	<i>Diesel</i>	2237cc.	C223	73	88.00	405
TC-393-07	AMIGO - PICK UP /S/LS/XS 1988/95 - RODEO /S/LS/XS 1991/95 - TROOPER II 1986/91 (8941742790/4311234)		2555cc.	4ZE1	116/122	92.60	405

JAC							
REF.	MODELO / MODEL		Cm ³	MOTOR / ENGINE	HP	Ø Pist.	PAG.
TC-880-15 TC-880-MG	J2 - J3 2011/...		1332cc.	HFC4EB1.3D 16V	91	75.00	405

JEEP							
REF.	MODELO / MODEL		Cm ³	MOTOR / ENGINE	HP	Ø Pist.	PAG.
TC-493-20 TC-493-MG	CHEROKEE - GRAND CHEROKEE - CHRYSLER : DAKOTA TD GRAND VOYAGER TD 1995/... - FORD : SCORPIO TDCI SCC/SCD	<i>Diesel</i>	2499cc. 2499cc.	VM425 VM41B - SCC/SCD	114/121 115/125	92.00 92.00	400
TC-655-20	CHEROKEE - GRAND CHEROKEE 1999/... - CHRYSLER : DAKOTA TD - CARAVAN	<i>Diesel</i>	3100cc. 3125cc.	VM 531 TD EXA	142 140	92.00 92.00	400
TC-845-15	CHEROKEE CJ/DJ/YJ - PICK UP 1981/86 - WRANGLER 1986/90 DODGE : CHEROKEE		4200cc.	258 AMC CHEROKEE		95.30	402
TC-944-07	GRAND CHEROKEE - LIBERTY 2002/... - DODGE: DAKOTA - RAM 2500 2002/... (53020673AC)		4701cc. 4701cc.	EVA V8 16V EVC V8 16V	235 235	93.00 93.00	405



KIA							
REF.	MODELO / MODEL		Cm ³	MOTOR / ENGINE	HP	Ø Pist.	PAG.
TC-735-07	PRIDE 91/... - FORD : LASER - FESTIVA - MAZDA : 323 - 121 - FAMILIA (KV0310271/B30110271)		1323cc.	OHC / B3	59/67	71.00	406
TC-844-07	PRIDE 1991/93 - FORD : FESTIVA 1988/93 - MAZDA : FAMILIA - 323 - 121 1987/91 (B30210271)		1323cc.	B3 DOHC	60/66	71.00	406
TC-755-07	SEPHIA - LEO - MENTOR 1994/... - MAZDA : FAMILIA - LASER - 323 MX3 1987/... (B61L10271)		1498cc. 1597cc.	B5 - B6 - B6E B6ZE 16V	80 81/88	78.00 78.00	406
TC-958-15	KIA : RIO - HYUNDAI : NEW ACCENT - GETZ - LANTRA (2231126101)		1599cc. 1599cc. 1599cc.	G4ED G4ED-G G4ED-L	104 103 90	76.50 76.50 76.50	404
TC-496-15	SPORTAGE 1995/99 - ASIA : ROCSTA 1994/... - FORD : PROBE 1989/92 MAZDA : CAPELLA - 626 - 929 - E1800 - E2000 - B2000 - FORKLIFT B2200 MX6 - TELSTER 1982/... (F20210271) (F80110271)		1789cc. 1998cc. 2184cc.	F8 FE F2 - F2L	83 83 147	86.00 86.00 86.00	406
TC-812-15	SPORTAGE - ASIA : ROCSTA - FORD : RANGER - PROBE/TURBO MAZDA : CAPELLA - B2200 - E1800 87/... - E2200 99/... - 929 - 626 MX6/TURBO 12V		1789cc. 1998cc. 2184cc.	F8 FE F2	83 82/109 147	86.00 86.00 86.00	407
TC-120-20	BESTA - BONGO - CERES .../1987 - ASIA : ROCSTA - MAZDA : E2000 - 626 CAPELLA E/B2200 - (0K77010271/R20210271/R20110271A/D/E)	Diesel	1998cc. 2184cc.	RF CX HW R2	65/75/82 64/72	86.00 86.00	407
TC-321-11	MAGENTIS - OPTIMA/EX/LX/SE 2001/06 - HYUNDAI : SONATA (2231138200/2231138C00)		2350cc. 2350cc.	G4JS 16V SIRIUS II 16V	136/149	86.50 86.50	404
TC-814-20 TC-814-MG	SORENTO CRDI - HYUNDAI : H1 2002/... (223114A010)		2497cc.	D4CB 16V	110/140	91.00	405
TC-329-11	MAGENTIS - OPTIMA 2004/06 - SPORTAGE 2004/10 HYUNDAI : TUCSON GL/GLS/LX/SE 2005/11 - COUPE - SANTA FE 2001/06 SONATA - TIBURON - TRAJET 2000/09 (2231137320) (DERECHA)		2600cc. 2600cc.	G6BA V6 24V G6BA-C V6 24V	165/170/175 165	86.70 86.70	404
TC-330-11	MAGENTIS - OPTIMA 2004/06 - SPORTAGE 2004/10 HYUNDAI : TUCSON GL/GLS/LX/SE 2005/11 - COUPE - SANTA FE 2001/06 SONATA - TIBURON - TRAJET 2000/09 (2231137310) (IZQUIERDA)		2600cc. 2600cc.	G6BA V6 24V G6BA-C V6 24V	165/170/175 165	86.70 86.70	404
TC-836-20	BESTA 1993/...	Diesel	2700cc.	VN	81	96.00	405

LADA							
REF.	MODELO / MODEL		Cm ³	MOTOR / ENGINE	HP	Ø Pist.	PAG.
TC-123-15	SAGONA - SAMARA - ALEKO - VAZ21083/21093 - FORMAN 1985/... (210831003020)		1499cc.	OHC	70/77	82.00	405

LANCIA							
REF.	MODELO / MODEL		Cm ³	MOTOR / ENGINE	HP	Ø Pist.	PAG.
TC-882-20 TC-882-MG	MUSA 2004/... - CHEVROLET : COMBO - AGILA - CORSA - ASTRA - TIGRA TD 2000/... MERIVA 2003/... - FIAT : DOBLO - SIENA - IDEA - PANDA - PUNTO GRANDE PUNTO JTD 16V 2002/...	Diesel	1248cc.	Z13DT - Y13DT 199A.3000/2000 188A.9000	69/90	69.60	399

LISTER							
REF.	MODELO / MODEL		Cm ³	MOTOR / ENGINE	HP	Ø Pist.	PAG.
TC-309-01 TC-309-15	1 CIL. 5 - 6 HP				5/6		406

MAZDA							
REF.	MODELO / MODEL		Cm ³	MOTOR / ENGINE	HP	Ø Pist.	PAG.
TC-735-07	323 - 121 - FAMILIA - FORD : FESTIVA - LASER - KIA : PRIDE 91/... (KV0310271/B30110271)		1323cc.	OHC / B3	59/67	71.00	406
TC-844-07	FAMILIA - 323 - 121 1987/91 - FORD : FESTIVA 1988/93 - KIA : PRIDE 1991/93 (B30210271)		1323cc.	B3 DOHC	60/66	71.00	406
TC-755-07	FAMILIA - LASER - 323 - MX3 1987/... - KIA : SEPHIA - LEO - MENTOR 1994/... (B61L10271)		1498cc. 1597cc.	B5 - B6 - B6E B6ZE 16V	80 81/88	78.00 78.00	406
TC-737-07	323 - FAMILIA - LASER - ETUDE 1987/... - FORD : TRACER - MERCURY (B63010271/A/C/B61610271)		1498cc. 1597cc.	B5 B6	72 101/105	78.00 78.00	406
TC-323-11	3/2 2003/... (ZY0110271)		1498cc. 1598cc.	DE5 16V LF 16V Z6 16V	103 105 105	78.00 78.00 78.00	406
TC-794-15	ALLEGRO (B6DC10271)		1597cc.	B6ZE - B6D	90/110	78.00	406
TC-340-20 TC-340-MG	323 FAMILIA 1986/94	Diesel	1720cc.	PN B6	55	78.00	406
TC-495-07	121 - 626 - 616 - 929 - B2000 - COSMO - CAPELLA - LUCE 1973/84 FORD : COURIER 1979/82 (045310271/A)		1769cc. 1970cc.	MA-VC	100 110	80.00 80.00	406
TC-496-15	CAPELLA - 626 - 929 - E1800 - E2000 - B2000 - FORKLIFT B2200 - MX6 TELSTER 1982/... - ASIA : ROCSTA 1994/... - FORD : PROBE 1989/92 KIA : SPORTAGE 1995/99 (F20210271) (F80110271)		1789cc. 1998cc. 2184cc.	F8 FE F2 - F2L	83 83 147	86.00 86.00 86.00	406
TC-812-15	CAPELLA - B2200 - E1800 87/... - E2200 99/... - 929 - 626 - MX6/TURBO 12V ASIA : ROCSTA - FORD : RANGER - PROBE/TURBO - KIA : SPORTAGE		1789cc. 1998cc. 2184cc.	F8 FE F2	83 82/109 147	86.00 86.00 86.00	407

MAZDA - Continuación...						
REF.	MODELO / MODEL		Cm ³	MOTOR / ENGINE	HP	Ø Pist. PAG.
TC-324-11	6 - FORD: CMAX - FOCUS 2006/... - MONDEO 2000/... - VOLVO: C30 - S40 V50 2005/... 16V		1798cc.	CGBA/CGBB/CHBA/CHBB	110/125	83.00
			1798cc.	CSDA/B QQDA/B	120/125	83.00
			1798cc.	Q7DA/B4184S8/11/L8	125/115/120	83.00
TC-119-06	CAPELLA - 626 1982/94 - FORD: ESCORT - TEMPO - ECONOVAN 1984/... (RF0310271)	Diesel	1998cc.	RF/D2	56/64	86.00 407
TC-120-20	E2000 - 626 - CAPELLA E/B2200 - ASIA: ROCSTA - KIA: BESTA - BONGO CERES .../1987 (0K77010271/R20210271/R20110271A/D/E)	Diesel	1998cc.	RF CX	65/75/82	86.00
			2184cc.	HW R2	64/72	86.00
TC-811-15	B2600 1987/94 - CHRYSLER: LEBARON - RAIDER - NEW YORKER - CARAVELLE RAM 50 - COUNTRY - VOYAGER - CARAVAN - 400 - 600 1981/89 MITSUBISHI: SAPPORO - SHOGUN - SIGMA - MONTERO - S - SP - SPX PAJERO - L200 1983/97 - STARION 1983/... (MD026654/MD110383)		2555cc.	G54B - 4G54 4G54B - AM	103 155	91.10 408

MITSUBISHI						
REF.	MODELO / MODEL		Cm ³	MOTOR / ENGINE	HP	Ø Pist. PAG.
TC-915-07	COLT - LANCER 1977/... - MIRAGE 1979/83 (MD030290/MD181369)		1244cc.	4G11	55	69.50
			1244cc.	G11B	54	69.50
TC-485-06	COLT - LANCER - MIRAGE 1977/... - HYUNDAI: PONY 1983/85 (MD030290)		1244cc.	G11B	72	69.50
			1298cc.	G4AG	87	69.50
TC-115-07	LANCER - MIRAGE - PROTON SAGA - PERSONA - ISWARA - WIRA 1988/... COLT - SATHIA (MD323473)		1298cc.	G13B	74	71.00
			1468cc.	G15B	90	75.50
TC-878-15	COLT - LACER 1996/2001 - VARICA - CARISMA 1995/... - MIRAGE 2002/...		1298cc.	4G13	55	71.00
			1497cc.	4G15	75.50	407
TC-482-15	COLT 1979/82 SOHC - LANCER - CORDIA 1978/86 - CHRYSLER: CHAMP HYUNDAI: EXCEL - PONY 1985/86 - MIRAGE - TREDIA - LANTRA (MD030293) (2231121010/100)		1410cc.	G12B/T - G4AJ	80/105	74.00
			1468cc.	G4J	74/84	75.50
TC-472-07	L200 - LANCER - SAPPORO - GALANT - CELESTE - LAMBA - SIGMA 1978/... CHRYSLER: ARROW - CHALLENGER - COLT - CHAMP (MD007515/8766/9451)		1597cc.	4G32 - G32B	86/100	77.00 407
TC-757-07	LANCER - COLT - GALANT - CELESTE - SAPPORO 1975/80 (MD000437)		1597cc.	G32	100	77.00 407
TC-833-07	LANCER - CARISMA - COLT 16V 1992/... - SPACE WAGON/RUNNER GALANT - ETERNA - MIRAGE 1991/... SOHC (MD184399)		1597cc.	4G91 - 4G92	100/103	81.00
			1834cc.	4G93/K	113/140	81.00
TC-834-07	ETERNA - SAVA - DELICA - L300 - L200 - L400 - SPACE GEAR 1994/... SPACE WAGON - GALANT 1992/99		1836cc.	4G63/B	133	85.00
			1997cc.	4G63K - 4G67	136	85.00
TC-811-15	SAPPORO - SHOGUN - SIGMA - MONTERO - S - SP - SPX - PAJERO - L200 1983/97 - STARION 1983/... - CHRYSLER: LEBARON - RAIDER - NEW YORKER CARAVELLE - RAM 50 - COUNTRY - VOYAGER - CARAVAN - 400 - 600 1981/89 MAZDA: B2600 1987/94 (MD026654 - MD110383)		2555cc.	G54B - 4G54 4G54B - AM	103 155	91.10 408

NISSAN						
REF.	MODELO / MODEL		Cm ³	MOTOR / ENGINE	HP	Ø Pist. PAG.
TC-857-07	SUNNY - CHERRY 1966/75 (11044H1000)		998cc.	A10	56	73.00
			1171cc.	A12	68	73.00
TC-859-15	SUNNY B11 - PULSAR - LANGREY 1980/84 - SENTRA - TSURU - SAMURAI SEDAN - NINJA - GAYIN 1984/94 (1104401M02)		1270cc.	E13S	75	76.00
			1485cc.	E15/S	85	76.00
			1597cc.	E16/S	85	76.00
TC-865-07	SUNNY - PULSAR 12V 1988/... - ISUZU: TRUCK LV 12V 1988/... (110487A00)		1392cc.	GA14S	79	73.60
			1497cc.	GA15E	97	73.60
TC-862-07	SUNNY - CHERRY - VANETTE - B310 1974/... - FORKLIFT 1985/... (11044H7200)		1397cc.	A14S	80	76.00
			1487cc.	A15-A15S	73/85	76.00
TC-858-07	HOMER CABSTAR F20 - TRUCK - HOMOY - CARAVAN - SEDAN - GUAYIN PICK UP ESTAQUILLAS 1970/... (11044B9500)		1483cc.	J15	77	78.00
			1567cc.	J16	80	78.00
TC-733-15	SENTRA - SUNNY - PULSAR - TSURU - VANETTE - ALMERA - PRIMERA - 200SX TSUBAME - LUCINO - SERENA INY. 1990/... (1104457Y00/0M600/10/200)		1597cc.	GA16-DE/DS/DNE/GE DOHC 16V	97/110	76.00 408
TC-489-07	BLUEBIRD - VIOLET - SKYLINE - STANZA - 180 - 200SX - 510 - 521 - 610 - 620 710 - 720 - 910 - SILVIA - LAUREL 1968/... (11044U0800/03/11/A8702)		1597cc.	L16 - L18/S/T	100	83.00
			1770cc.	L20B	105/110	85.00
			1952cc.			
TC-863-07	STANZA T11 - AUSTER - LIBERTA - SILVIA - VIOLET 1980/84 BLUEBIRD 1983/... (11044D0100/1/2/3)		1598cc.	CA16/S/D	90	78.00 408
TC-127-20	SENTRA - SUNNY - CHERRY - PULSAR 1982/... (1104454A02/16A00/01/02/05/06/07)	Diesel	1680cc.	CD17	54/61	80.00 409
TC-545-07	BLUEBIRD - VANETTE - TRADE 1980/... (11044W1700)	Diesel	1952cc.	LD20/E	58/60	85.00 409
TC-864-07	BLUEBIRD - VANETTE - TRADE - SERENA 1985/... (1104413C00)	Diesel	1952cc.	LD20 II - C22 LD20T - LD20D	58/79	85.00 409
TC-163-20 TC-163-MG	PRIMERA - PULSAR - ALMERA - SUNNY - AVENIR - VANETTE 1997/98 (110440C400/01/02/03)	Diesel	1974cc.	CD20	75	84.50 409



NISSAN - Continuación...							
REF.	MODELO / MODEL		Cm ³	MOTOR / ENGINE	HP	Ø Pist.	PAG.
TC-541-06	CEDRIC - PICKUP 720 - CABALL - CABSTAR - CLIPPER - HOMER - JUNIOR CIVILIAN - CARAVAN - GLORIA 1970/... (11044Y1400/01)	<i>Diesel</i>	1991cc.	SD20	60	83.00	402
			2164cc.	SD22	65	83.00	
TC-861-07	TRUCK 2400 - PATHFINDER - TERRANO - PICK UP 1983/92 DATSUN: FORKLIFT - D21 1983/92 - VANETTE - URVAN 1987/...(104410W01/02)		2187cc.	Z22E/S	103	87.00	401
			2389cc.	Z24S/I		89.00	
TC-951-07	X TRAIL - ALTIMA 2002/... - SENTRA 2003/... (110446N201/8J022/6)		2488cc.	QR25DE 16V	165/177	89.00	409
TC-590-06	CEDRIC - FAIRLADY - LAUREL - PATROL - 280Z 1975/... (11044N4200/10/20)		2753cc.	L28S	121/140	86.00	409
TC-546-06	LAUREL - CEDRIC - MAXIMA - 810 - 280C - SKYLINE - BLUEBIRD 1980/... (11044W2500/01/02/V0700)	<i>Diesel</i>	2793cc.	LD28	84	84.50	409
TC-909-11	PATROL 1989/00 - SAFARI 1997/... (1104422J10/11044VB300)	<i>Diesel</i>	2826cc.	RD28 / RD28T	101/129	85.00	409
TC-578-06	CIVILIAN BUS - CLIPPER - C240 - 340 - 341 1973/... (11044J2000/J5500/03)	<i>Diesel</i>	2956cc.	ED30	76	98.00	409
TC-336-11	FRONTIER (110441W400/110441W402)	<i>Diesel</i>	3100cc.	QD32	103	99.20	410

OPEL							
REF.	MODELO / MODEL		Cm ³	MOTOR / ENGINE	HP	Ø Pist.	PAG.
TC-882-20 TC-882-MG	COMBO - AGILA - CORSA - ASTRA - TIGRA TD 2000/... MERIVA 2003/... FIAT: DOBLO - SIENA - IDEA - PANDA - PUNTO - GRANDE PUNTO JTD 16V 2002/... - LANCIA: MUSA 2004/...	<i>Diesel</i>	1248cc.	Z13DT - Y13DT	69/90	69.60	399
				199A.3000/2000 188A.9000		76.00	
TC-602-20 TC-602-MG	CORSA A/B - KADETTE 1984/99 - ISUZU: I-MARK - GEMINI 1985/... (8943864430) (8941501940/2) (8944716200/1)	<i>Diesel</i>	1468cc.	4EC1 - T4EC1	50	76.00	404
			1487cc.	15D/T - X15D/T	76	76.00	

PIAGGIO							
REF.	MODELO / MODEL		Cm ³	MOTOR / ENGINE	HP	Ø Pist.	PAG.
TC-121-06	PORTER 1994/...	<i>Diesel</i>	1221cc.	ECO	36	72.00	410

RENAULT							
REF.	MODELO / MODEL		Cm ³	MOTOR / ENGINE	HP	Ø Pist.	PAG.
TC-786-15 TC-786-MG	KWID 2017/... - LOGAN II - SANDERO II 2016/... (110442970R)		999cc.	B4D 12V	82	71.00	410
TC-335-15	R12 - R15 - R16 - R17 - R18 - R20 - FUEGO - TRAFIC 1972/... (7701457060/7701460708)		1647cc.	841-843-A2M23	65/79	79.00	410

ROVER							
REF.	MODELO / MODEL		Cm ³	MOTOR / ENGINE	HP	Ø Pist.	PAG.
TC-837-07	213 1984/89 - HONDA: CIVIC COUPE/SI - BALLADE CRX (12251PE0003)		1200cc.	EW1-EW2-EW3	80	74.00	403
			1342cc.	EW4-EV-EV1	100	74.00	
			1488cc.	EV2		74.00	
TC-350-11	216 - 416 1992/94 - ACURA: EL - OH 1622 2000/... - HONDA: ACCORD - CITY 1999/03 - CIVIC/VTEC/VTEC-E 1992/00 - CRX VTEC 1992/98 - HRV 1999/05		1342cc.	D13B6/7/8	95/65	75.00	403
			1396cc.	D14A/Z	75/90	75.00	
			1493cc.	D15Z	101/114	75.00	
			1590cc.	D16B/W/Y/Z	105/125	75.00	

SKODA							
REF.	MODELO / MODEL		Cm ³	MOTOR / ENGINE	HP	Ø Pist.	PAG.
TC-874-07	FAVORIT - FELICIA - FORMAN 1989/96 (77105407)		1289cc.	115 - 135 - 136	50/55/62	75.50	410

SMART							
REF.	MODELO / MODEL		Cm ³	MOTOR / ENGINE	HP	Ø Pist.	PAG.
TC-920-15 TC-920-MG	FORTWO 2007/... (1320160020)		999cc.	M132.930	84	72.00	410

SUBARU							
REF.	MODELO / MODEL		Cm ³	MOTOR / ENGINE	HP	Ø Pist.	PAG.
TC-475-07	LEONE - BRAT - MV PICK UP 2 CIL. 1979/93 (412307102/12/22)		1595cc.	EA71	71/87	92.00	410
TC-835-07	LEONE - LOYALE TURBO - RXGL - XT - MV 1985/94 (11044AA001/3/11)		1781cc.	EA82/T-EA85	90/136	92.00	410

SUZUKI							
REF.	MODELO / MODEL		Cm ³	MOTOR / ENGINE	HP	Ø Pist.	PAG.
TC-732-15	ALTO 3CIL. 1980/... DAEWOO: TICO (1114178400/440)		796cc.	F8 - F8B - AB51	41	68.50	401
TC-840-07	ALTO (1114184410)		796cc.	F8D	47	68.50	410
TC-779-07	MARUTI - ALTO - A-STAR - CELERIO - FRONTE (11141M53M00)		796cc.	F8DN	35	68.50	410
TC-729-15	SWIFT INY. - CULTUS 1988/... - CHEVROLET: SPRINT 1989/... (1114160301)		993cc.	G10A - 61	55	74.00	399
TC-841-07	ZEN NEW ALTO 1994/2002 (1114172F10)		993cc.	YE2 - G10B	54	72.00	411
TC-842-07	WAGON R (1114179F10)		1061cc.	F10D	62	68.50	411
TC-339-11	GRAND VITARA - IGNIS /II 2000/08 - JIMNY 2001/02 - LIANA 2001/03 SWIFT /III 2005/... (1114169G01/1114169G03)		1324cc.	M13A 16V	82/83/90/92	78.00	411
			1490cc.	M15A 16V	101	78.00	
			1586cc.	M16/A 16V	103/106	78.00	

TOYOTA							
REF.	MODELO / MODEL		Cm ³	MOTOR / ENGINE	HP	Ø Pist.	PAG.
TC-341-11	VITZ 1998/... - ECHO 1999/05 - YARIS 1999/... (1111523030)		998cc.	1SZ-FE	68	69.00	411

TOYOTA - Continuación...						
REF.	MODELO / MODEL		Cm ³	MOTOR / ENGINE	HP	Ø Pist. PAG.
TC-847-07	COROLLA - STARLET - PUBLICA 1967/77 - KE30/40/45/60 - SPRINTER DAIHATSU: CHARMANT 1975/77 (1111524013)		1077cc. 1166cc.	3K-H/3K-U/3K-J K-3KC	64/68	75.00 75.00 411
TC-477-07	COROLLA - STARLET - LITEACE - SPRINTER - TOWNACE 1977/... DAIHATSU: CHARMANT - CONSORTE (1111513030/31)		1166cc. 1290cc.	3K/U/J-4K-4KU	64 74	75.00 75.00 411
TC-849-07	STARLET - COROLLA 12V 1984/96 - TERCEL 1986/... (1111511010/60)		1295cc. 1456cc.	2E - 2E-E/L/U/C/E/LC 3E - 3E-E	75/82 83	73.00 73.00 411
TC-345-11	BELTA - YARIS 2002/... DAIHATSU: SIRION - MINISTAR 2000/05 - TERIOS YRV - TOWNER 2000/05		1298cc. 1298cc.	2SZ-FE 16V K3-VE/VET 16V	87 84/102/140	72.00 72.00 411
TC-344-11	AVANZA - AVANZADA 2006/... - RUSH 2008/09 - DAIHATSU: MATERIA PRISMA 2006/... - SIRION - MINISTAR 2008/... - TERIOS 2005/...		1298cc. 1495cc.	K3-VE 3SZ-VE	90 103/105/109	72.00 72.00 411
TC-382-11	COROLLA - ECHO /VERSO 1998/2005 - AVANZA 1999/... - PLATZ 2002/2005 PRIUS 1999/2009 - SOLUNA VIOS 2003/07 - VIOS 2003/05 - VITZ 1998/01 YARIS 1998/05 (1111521030/1111521050)		1298cc. 1497cc.	2NZ-FE 1NZ-FE/FXE	85/87 106	75.00 75.00 411
TC-900-07	COROLLA 1990/97 - TERCEL 1990/95 - PASEO 1990/95 - STARLET 1990/99 (1111511070/71/80)		1332cc. 1497cc.	4E-FE 5E-FE	75 90	74.00 74.00 412
TC-850-07	COROLLA - CARINA - TERCEL - CORSA 1978/83 - SPRINTER DAIHATSU: CHARMANT 1981/83 (1111515020/30/41)		1452cc.	1A - 3A - 1AU - 3AU	80	77.50 412
TC-272-20 TC-272-MG	COROLLA - STARLET 1987/96 (ESP 1,45mm)	Diesel	1453cc.	1N	54	74.00 412
TC-851-07	COROLLA - LITEACE KE74A 1984/... - DAIHATSU: DELTA WIDE 1990/... (1111513040)		1486cc.	5K-J/5K-U	68	80.50 412
TC-854-07	COROLLA - CARINA - LEVIN - TRUENO - SOLUNA 1992/...16V (1111515072)		1498cc.	5AF/FE	95	78.70 412
TC-591-15	COROLLA 16V/1992/2000 - CARINA AVENSIS (1111516130/150)		1587cc.	4AFE (DOHC)	90	81.00 412
TC-852-15	COROLLA AE95/92/1987/1992 - CELICA - CARINA (1111516080/81/82/90/100)		1587cc.	4AFE / 4AF	90/95/105	81.00 412
TC-478-07	CARINA - CELICA - TOWNACE - CAMRY - COROLLA - SPRINTER - CORONA 1970/82 - DAIHATSU: CHARMANT - DELTA WIDE 1970/82 (1111526031)		1588cc. 1778cc.	2T-2TJ-3T-12TU-13T	100 105	85.00 412
TC-846-07	CORONA - HILUX - HIACE - RN20 - TOYO - ACE 1971/75 - TOWNACE 1976/... DAIHATSU: DELTA 1972/75 - TAFT 1976/81 (1111531020)		1588cc.	12R/R-J/R-U	80/83	80.50 412
TC-490-06	HILUX - CORONA - MARK II - CELICA - MARK - CRESSIDA - HIACE CARINA 1966/.. (1111533010/11-1111534010/20/30-1111536010/20)		1591cc. 1707cc. 1808cc. 1968cc.	7R 6R 16R 18R	85 85 110 110	86.00 86.00 88.50 88.50 413
TC-343-11	AURIS 2006/... - COROLLA VERSO 2006/... (1111537030)		1598cc. 1798cc.	12R-FE 2ZR-FAE	124 147	80.50 80.50 413
TC-593-15	COROLLA 1992/2001 16V - CARINA - CELICA 1993/99 (1111516120/121)		1762cc.	7A-FE	106/110	81.00 412
TC-554-20 TC-554-MG	COROLLA - TOWNACE - CARINA - DAHATSU: DELTA WIDE 1982/88 (1111564010/20)	Diesel	1839cc.	1C	64	83.00 413
TC-518-06	CELICA GT - CARINA GT DOHC 1977/... (1111588231/70)		1968cc.	18R-GU/GEU	130	89.00 413
TC-903-11	RAV4 1996/01 - CARINA E 1996/97 - CORONA - PICNIC - AVENSIS (1111574110)		1998cc.	3S-FE	117	86.00 413
TC-574-20	HILUX - CROWN - TOYO ACE - HIACE - CRESSIDA - CHASSER - BLIZZARD MARK II 1977/... (1111554010/11/12/20/21)	Diesel	2188cc. 2446cc.	L 2L/LT/LTE	67/72 75/83/86	90.00 92.00 413
TC-848-07	DYNA - HILUX - COASTER - CORONA - CELICA - 4 RUNNER 1980/84 TURBO 1985/96 - LANDCRUISER (1111535010)		2367cc.	22R - 22REC 22RTEC	100 114	92.00 92.00 413
TC-553-06	COASTER - DYNA - LANDCRUISER - DELTA 1972/80 (1111556010/11)	Diesel	2977cc. 3168cc.	B 2B	85 98	95.00 98.00 413
TC-856-07	LANDCRUISER F J62 1989/92 (1111561020)		3956cc.	3F/E	140	94.00 413
TC-855-07	LANDCRUISER 6 CIL. FJ60 1975/84 (1111561010)		4230cc.	2F OHV	140	94.00 413

VM						
REF.	MODELO / MODEL		Cm ³	MOTOR / ENGINE	HP	Ø Pist. PAG.
TC-493-20 TC-493-MG	CHRYSLER: DAKOTA TD - GRAND VOYAGER TD 1995/... FORD: SCORPIO TDCI SCC/SCD - JEEP: CHEROKEE - GRAND CHEROKEE	Diesel	2499cc. 2499cc.	VM425 VM41B - SCC/SCD	114/121 115/125	92.00 92.00 400
TC-655-20	CHRYSLER: DAKOTA TD - CARAVAN - JEEP: CHEROKEE GRAND CHEROKEE 1999/...	Diesel	3100cc. 3125cc.	VM 531 TD EXA	142 140	92.00 92.00 400

VOLKSWAGEN						
REF.	MODELO / MODEL		Cm ³	MOTOR / ENGINE	HP	Ø Pist. PAG.
TC-142-20	BOTADOR HIDRAULICO - SENDA - SAVEIRO - GOL	Diesel	1588cc.		54/70	76.50 414

VOLVO						
REF.	MODELO / MODEL		Cm ³	MOTOR / ENGINE	HP	Ø Pist. PAG.
TC-324-11	C30 - S40 - V50 2005/... 16V - FORD: CMAX - FOCUS 2006/... MONDEO 2000/... - MAZDA: 6		1798cc. 1798cc. 1798cc.	CGBA/CGBB/CHBA/CHBB CSDA/B QQDA/B Q7DA/B4184S8/11/L8	110/125 120/125 125/115/120	83.00 83.00 83.00 402
TC-690-15	S70 LS - V70 LV - 850 (3531017/35310176)		2435cc. 2435cc. 2435cc.	B5252/S/FS B5254F/S/T GB5252S	140 144 144	83.00 83.00 83.00 414

JUNTAS CULATA DE CILINDROS (TC)

Modelos No incluídos en los Juegos Completos de Reparación

ILLINOIS



JUNTA DE CABEÇOTE Modelos não incluídos nos Jogo de Juntas do Motor
CYLINDER HEAD GASKET Models not included in Full Set Gasket

MARCA / Brand	CÓDIGO	DIÁMETRO	ESPEJOR
ALFA ROMEO	TC-761-15	Ø 84.00mm	≅ 1.70mm
DESCRIPCIÓN / Descrição / Description			
145/146/155/156 TWIN SPARK 16V 1996/...			
MOTOR / Engine		CM3	HP Ø PISTÓN
676.01		1598	120 82.00
671.06 - 671.99 - 322.01		1747	140/144 82.00

MARCA / Brand	CÓDIGO	DIÁMETRO	ESPEJOR
CHEVROLET/SUZUKI	TC-729-15	Ø 75.00mm	≅ 1.60mm
DESCRIPCIÓN / Descrição / Description			
SPRINT 1989/... SUZUKI: SWIFT INY. - CULTUS 1988/... (1114160301)			
MOTOR / Engine		CM3	HP Ø PISTÓN
G10A - 61		993	55 74.00

MARCA / Brand	CÓDIGO	DIÁMETRO	ESPEJOR
BMW	TC-519-06	Ø 89.50mm	≅ 1.40mm
DESCRIPCIÓN / Descrição / Description			
316(E21) - 315 - 318 - 518 - 320 520 1963/82 4 CIL. (11129065653/11121734279)			
MOTOR / Engine		CM3	HP Ø PISTÓN
M10 B16/B18		1573	85 84.00
		1773	90 89.00
			98 89.00

MARCA / Brand	CÓDIGO	DIÁMETRO	ESPEJOR
CHEVROLET/OPEL/FIAT	TC-882-MG 0M	Ø 70.50mm	≅ 1.00mm
	TC-882-MG 1M	Ø 70.50mm	≅ 1.10mm
	TC-882-MG 2M	Ø 70.50mm	≅ 1.20mm
DESCRIPCIÓN / Descrição / Description			
COMBO - AGILA - CORSA - ASTRA TIGRA TD 2000/... - MERIVA 2003/... FIAT: DOBLO - SIENA - IDEA - PANDA PUNTO - GRANDE PUNTO JTD 16V 2002/... LANCIA: MUSA 2004/...			
MOTOR / Engine		DIESEL CM3	HP Ø PISTÓN
Z13DT - Y13DT 188A.9000 - 199A.2000/3000		1248	69/90 69.60

MARCA / Brand	CÓDIGO	DIÁMETRO	ESPEJOR
BMW	TC-507-06	Ø 82.00mm	≅ 1.85mm
DESCRIPCIÓN / Descrição / Description			
320/I - 520/I - 323I (E21) 1977/93 6 CIL. (11121722725)			
MOTOR / Engine		CM3	HP Ø PISTÓN
M20 B20/B23		1990	122 80.00
		2315	150 80.00

MARCA / Brand	CÓDIGO	DIÁMETRO	ESPEJOR
ISUZU/CHEVROLET	TC-467-15	Ø 84.00mm	≅ 1.60mm
DESCRIPCIÓN / Descrição / Description			
GEMINI - FASTER - CHEVROLET: LUV RODEO - 117 COUPE - CAMPO FLORIAN 1975/87 (8942104410) (8942118650)(8942168690/8700)			
MOTOR / Engine		CM3	HP Ø PISTÓN
G161Z - G180Z		1584	100 82.00
		1817	100 84.00

MARCA / Brand	CÓDIGO	DIÁMETRO	ESPEJOR
BMW	TC-508-06	Ø 85.30mm	≅ 1.70mm
DESCRIPCIÓN / Descrição / Description			
323 - 523 - 325 - 525 - 328 - 528 24V 1989/96 6 CIL. (11121726617)			
MOTOR / Engine		CM3	HP Ø PISTÓN
M50 B25		2494	192 84.00

MARCA / Brand	CÓDIGO	DIÁMETRO	ESPEJOR
ISUZU/CHEVROLET	TC-130-20 0M	Ø 86.00mm	≅ 1.30mm
	TC-130-20 1M	Ø 86.00mm	≅ 1.50mm
	TC-130-MG 0M	Ø 86.00mm	≅ 1.30mm
	TC-130-MG 1M	Ø 86.00mm	≅ 1.50mm
DESCRIPCIÓN / Descrição / Description			
I - MARK - GEMINI CHEVROLET: LUV - FARGO - ASKA OPEL MIDI 1980/... (8942350600) (8842480270)(8941166570)			
MOTOR / Engine		DIESEL CM3	HP Ø PISTÓN
4FB1 - 4FC1		1817	61 84.00
		1995	66 84.00

MARCA / Brand	CÓDIGO	DIÁMETRO	ESPEJOR
BMW	TC-556-07	Ø 87.70mm	≅ 1.90mm
DESCRIPCIÓN / Descrição / Description			
535 - 635 6 CIL. (BOCA CHICA)			
MOTOR / Engine		CM3	HP Ø PISTÓN

MARCA / Brand	CÓDIGO	DIÁMETRO	ESPEJOR
CHEVROLET	TC-731-07	Ø 85.00mm	≅ 1.50mm
DESCRIPCIÓN / Descrição / Description			
FARGO - WFR 11DV - ASKA SHUTTLE 1982/... (8941653240)			
MOTOR / Engine		CM3	HP Ø PISTÓN
4ZB1		1817	97/105 84.00

JUNTAS CULATA DE CILINDROS (TC)

Modelos No incluidos en los Juegos Completos de Reparación



JUNTA DE CABEÇOTE Modelos não incluídos nos Jogo de Juntas do Motor
CYLINDER HEAD GASKET Models not included in Full Set Gasket

MARCA / Brand	CÓDIGO	DIÁMETRO	ESPEJOR	
CHEVROLET	TC-924-11 0M	∅ 87.00mm	≠ 1.05mm	
	TC-924-11 1M	∅ 87.00mm	≠ 1.15mm	
	TC-924-11 2M	∅ 87.00mm	≠ 1.25mm	
DESCRIPCIÓN / Descrição / Description				
CAPTIVA 4WD - CRUZE CDI 16V (25190137/8/9/4818004/5/6)				
MOTOR / Engine	DIESEL	CM3	HP	∅ PISTÓN
LNP		1998	150	86.00
Z20D1		1998	131	86.00
Z22D1		2231	163	86.00

MARCA / Brand	CÓDIGO	DIÁMETRO	ESPEJOR	
CHRYSLER	TC-655-20 0M	∅ 98.00mm	≠ 1.40mm	
	TC-655-20 1M	∅ 98.00mm	≠ 1.50mm	
	TC-655-20 2M	∅ 98.00mm	≠ 1.60mm	
DESCRIPCIÓN / Descrição / Description				
CHRYSLER: DAKOTA TD - CARAVAN JEEP: GRAND CHEROKEE 2001/... CHEROKEE				
MOTOR / Engine	DIESEL	CM3	HP	∅ PISTÓN
VM 531 TD		3100	142	92.00
EXA		3125	140	92.00

MARCA / Brand	CÓDIGO	DIÁMETRO	ESPEJOR	
CHEVROLET	TC-806-11	∅ 87.50mm	≠ 1.60mm	
DESCRIPCIÓN / Descrição / Description				
ASTRA ELITE - ZAFIRA ELITE VECTRA ELITE - BLAZER - S10 8V/16V (MLS)				
MOTOR / Engine		CM3	HP	∅ PISTÓN
MPFI - X24SFD OHC		2405	142 128	86.00

MARCA / Brand	CÓDIGO	DIÁMETRO	ESPEJOR	
CHRYSLER	TC-486-15	∅ 102.50mm	≠ 1.40mm	
DESCRIPCIÓN / Descrição / Description				
DAKOTA - PICK UP 1996/...				
MOTOR / Engine		CM3	HP	∅ PISTÓN
V6		3900	130	99.30

MARCA / Brand	CÓDIGO	DIÁMETRO	ESPEJOR	
BEDFORD	TC-113-09	∅ 101.70mm	≠ 1.60mm	
DESCRIPCIÓN / Descrição / Description				
CHEVROLET J6 1956/61				
MOTOR / Engine	DIESEL	CM3	HP	∅ PISTÓN
300 D		4927	97	98.30

MARCA / Brand	CÓDIGO	DIÁMETRO	ESPEJOR	
CHRYSLER	TC-689-15	∅ 102.00mm	≠ 1.15mm	
DESCRIPCIÓN / Descrição / Description				
CHEROKEE - GRAND CHEROKEE SPORT - COMANCHE - WAGONEER WRANGLER 1986/2001				
MOTOR / Engine		CM3	HP	∅ PISTÓN
240 - 242/L		3960	185	98.40

MARCA / Brand	CÓDIGO	DIÁMETRO	ESPEJOR	
CHEVROLET	TC-147-05	∅ -----	≠ 1.80mm	
DESCRIPCIÓN / Descrição / Description				
6 CIL. 1929/33				
MOTOR / Engine		CM3	HP	∅ PISTÓN

MARCA / Brand	CÓDIGO	DIÁMETRO	ESPEJOR	
CIMARRON	TC-451-20	∅ 101.00mm	≠ 1.60mm	
DESCRIPCIÓN / Descrição / Description				
3300 DE 1976/85				
MOTOR / Engine	DIESEL	CM3	HP	∅ PISTÓN
3300 D		3285	88	98.30

MARCA / Brand	CÓDIGO	DIÁMETRO	ESPEJOR	
CHRYSLER	TC-493-20 0M	∅ 98.00mm	≠ 1.40mm	
	TC-493-20 1M	∅ 98.00mm	≠ 1.50mm	
	TC-493-20 2M	∅ 98.00mm	≠ 1.60mm	
	TC-493-MG 0M	∅ 98.00mm	≠ 1.40mm	
	TC-493-MG 1M	∅ 98.00mm	≠ 1.50mm	
	TC-493-MG 2M	∅ 98.00mm	≠ 1.60mm	
DESCRIPCIÓN / Descrição / Description				
CHRYSLER: DAKOTA TD - GRAND VOYAGER TD 1995/... FORD: SCORPIO TDCI SCC/SCD JEEP: CHEROKEE - GRAND CHEROKEE				
MOTOR / Engine	DIESEL	CM3	HP	∅ PISTÓN
VM425		2499	114/121	92.00
VM41B - SCC/SCD		2499	115/125	92.00

MARCA / Brand	CÓDIGO	DIÁMETRO	ESPEJOR	
CIMARRON	TC-458-06	∅ 101.00mm	≠ 1.60mm	
DESCRIPCIÓN / Descrição / Description				
3300 MODELO NUEVO 1986/...				
MOTOR / Engine	DIESEL	CM3	HP	∅ PISTÓN
3300 D		3283	89	98.42

JUNTAS CULATA DE CILINDROS (TC)

Modelos No incluidos en los Juegos Completos de Reparación

ILLINOIS

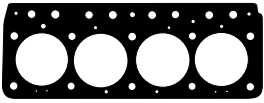

JUNTA DE CABEÇOTE Modelos não incluídos nos Jogo de Juntas do Motor
CYLINDER HEAD GASKET Models not included in Full Set Gasket

MARCA / Brand	CÓDIGO	DIÁMETRO	ESPEJOR
CIMARRON	TC-449-06	Ø 109.00mm	≅ 1.60mm
DESCRIPCIÓN / Descrição / Description			
3800 DE 1979/85			
			
MOTOR / Engine		CM3	HP Ø PISTÓN
3800D		3840	99 106.40

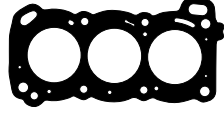
MARCA / Brand	CÓDIGO	DIÁMETRO	ESPEJOR
DAIHATSU	TC-582-06	Ø 77.20mm	≅ 1.55mm
DESCRIPCIÓN / Descrição / Description			
CUORE - DOMINO - MIRA - MOVE MAX CUORE 1986/... (1111587208)			
			
MOTOR / Engine		CM3	HP Ø PISTÓN
ED - ED20		846	41 66.60

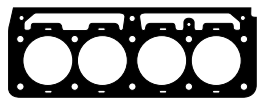
MARCA / Brand	CÓDIGO	DIÁMETRO	ESPEJOR
CIMARRON	TC-640-06	Ø 109.00mm	≅ 1.60mm
DESCRIPCIÓN / Descrição / Description			
3800 MODELO NUEVO 1986/...			
			
MOTOR / Engine		CM3	HP Ø PISTÓN
3800D		3840	99 106.40

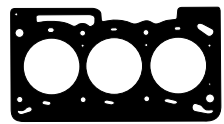
MARCA / Brand	CÓDIGO	DIÁMETRO	ESPEJOR
DAIHATSU	TC-111-06	Ø 77.20mm	≅ 1.45mm
DESCRIPCIÓN / Descrição / Description			
CHARADE TURBO 12V GTTI 1987/93 (1111587724)			
			
MOTOR / Engine		CM3	HP Ø PISTÓN
CB80T		993	101 76.00

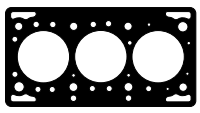
MARCA / Brand	CÓDIGO	DIÁMETRO	ESPEJOR
DAEWOO/SUZUKI	TC-732-15	Ø 70.00mm	≅ 1.20mm
DESCRIPCIÓN / Descrição / Description			
TICO - SUZUKI: ALTO 3CIL. 1980/... (1114178400/440)			
			
MOTOR / Engine		CM3	HP Ø PISTÓN
F8 - F8B - AB51		796	41 68.50

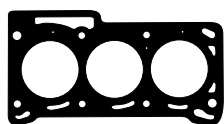
MARCA / Brand	CÓDIGO	DIÁMETRO	ESPEJOR
DAIHATSU	TC-613-15	Ø 78.00mm	≅ 1.50mm
DESCRIPCIÓN / Descrição / Description			
CHARADE - HI JET 1983/... S70 - S75 - G100 - G10 - G11 (1111587702/05/10/14/24/29)			
			
MOTOR / Engine		CM3	HP Ø PISTÓN
CB-CB10/20/22/23 CB51/90/41/42		993	45/50/52 68/54/45/48 76.00

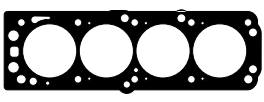
MARCA / Brand	CÓDIGO	DIÁMETRO	ESPEJOR
DAEWOO	TC-106-15	Ø 79.30mm	≅ 1.50mm
DESCRIPCIÓN / Descrição / Description			
NEXIA - CIELO - ESPERO 1994/97 KALOS 2002/... (96181216)			
			
MOTOR / Engine		CM3	HP Ø PISTÓN
G15MF - F14S3		1399 1498	83 75 77.90 76.50

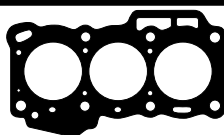
MARCA / Brand	CÓDIGO	DIÁMETRO	ESPEJOR
DAIHATSU	TC-843-07	Ø 77.50mm	≅ 1.70mm
DESCRIPCIÓN / Descrição / Description			
CHARADE G30 1983/87 3 CIL. (1111587713/19/20)			
			
MOTOR / Engine		CM3	HP Ø PISTÓN
CL10		993	38 76.00

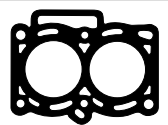
MARCA / Brand	CÓDIGO	DIÁMETRO	ESPEJOR
DAIHATSU	TC-447-06	Ø 74.20mm	≅ 1.55mm
DESCRIPCIÓN / Descrição / Description			
55 WIDE CAB - MAX CUORE - HI JET CAB VAN - L40 - S10 - S60 FELLOW 1977/... (1111587701/03)			
			
MOTOR / Engine		CM3	HP Ø PISTÓN
AB		547	71.60

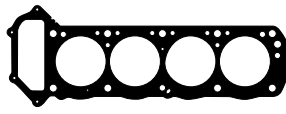
MARCA / Brand	CÓDIGO	DIÁMETRO	ESPEJOR
DATSUN	TC-861-07	Ø 90.00mm	≅ 1.40mm
DESCRIPCIÓN / Descrição / Description			
TRUCK 2400 - PATHFINDER - PICK UP TERRANO - DATSUN: FORKLIFT D21 1983/92 - VANETTE URVAN 1987/... (1104410W01/02)			
			
MOTOR / Engine		CM3	HP Ø PISTÓN
Z22E/S Z24S/I		2187 2389	103 87.00 89.00

JUNTAS CULATA DE CILINDROS (TC)

Modelos No incluidos en los Juegos Completos de Reparación

JUNTA DE CABEÇOTE Modelos não incluídos nos Jogo de Juntas do Motor
CYLINDER HEAD GASKET Models not included in Full Set Gasket



MARCA / Brand	CÓDIGO	DIÁMETRO	ESPEJOR
DATSUN	TC-541-06	∅ 86.00mm	≅ 1.60mm
DESCRIPCIÓN / Descrição / Description			
CEDRIC - PICKUP 720 - CABALL CABSTAR - CLIPPER - HOMER JUNIOR - CIVILIAN - CARAVAN GLORIA 1970/... (11044Y1400/01)			
MOTOR / Engine	DIESEL	CM3	HP ∅ PISTÓN
SD20		1991	65 83.00
SD22		2164	65 83.00

MARCA / Brand	CÓDIGO	DIÁMETRO	ESPEJOR
FORD	TC-623-15	∅ 83.50mm	≅ 1.60mm
DESCRIPCIÓN / Descrição / Description			
FIESTA I/XR2 - ESCORT/XR3I ORION TURBO 1980/... (92SM6051BA)			
MOTOR / Engine		CM3	HP ∅ PISTÓN
CVH(HL) - (HL16CFI/EFI)		1296	60 80.00
		1597	108 80.00

MARCA / Brand	CÓDIGO	DIÁMETRO	ESPEJOR
DIAR	TC-548-01	∅ 127.00mm	≅ 1.90mm
DESCRIPCIÓN / Descrição / Description			
1 CIL. MOTOR ESTACIONARIO			
MOTOR / Engine		CM3	HP ∅ PISTÓN

MARCA / Brand	CÓDIGO	DIÁMETRO	ESPEJOR
FORD	TC-647-15	∅ 80.00mm	≅ 1.50mm
DESCRIPCIÓN / Descrição / Description			
FIESTA - ESCORT 1986/98 ORION 1986/94			
MOTOR / Engine		CM3	HP ∅ PISTÓN
HL14G - CFI - EFI		1392	73/75 77.20

MARCA / Brand	CÓDIGO	DIÁMETRO	ESPEJOR
DIAR	TC-559-01	∅ 122.00mm	≅ 1.90mm
DESCRIPCIÓN / Descrição / Description			
1 CIL. MOTOR ESTACIONARIO			
MOTOR / Engine		CM3	HP ∅ PISTÓN

MARCA / Brand	CÓDIGO	DIÁMETRO	ESPEJOR
FORD	TC-956-15 TC-956-MG	∅ 80.60mm ∅ 80.60mm	≅ 1.50mm ≅ 1.50mm
DESCRIPCIÓN / Descrição / Description			
FOCUS - FIESTA 1998/... (1097083/1253985/ 3S4G6051CA/ C60110271/YS4G6051CA)			
MOTOR / Engine		CM3	HP ∅ PISTÓN
ZETEC SE 16V		1596	101/103 79.00

MARCA / Brand	CÓDIGO	DIÁMETRO	ESPEJOR
DODGE	TC-845-15	∅ --.--mm	≅ 1.40mm
DESCRIPCIÓN / Descrição / Description			
CHEROKEE JEEP: CHEROKEE CJ/DJ/YJ PICK UP 1981/86 WRANGLER 1986/90			
MOTOR / Engine	DIESEL	CM3	HP ∅ PISTÓN
258 AMC CHEROKEE		4200	95.30

MARCA / Brand	CÓDIGO	DIÁMETRO	ESPEJOR
FORD	TC-324-11	∅ 84.70mm	≅ 0.95mm
DESCRIPCIÓN / Descrição / Description			
CMAX - FOCUS 2006/... - MONDEO 2000/... - MAZDA: 6 - VOLVO: C30 - S40 - V50 2005/...			
MOTOR / Engine		CM3	HP ∅ PISTÓN
CGBA/CGBB/CHBA/CHBB 16V		1798	110/125 83.00
CSDA/B QQDA/B 16V		1798	120/125 83.00
Q7DA/B4184S8/11 16V / L8 16V		1798	125/115/120 83.00

MARCA / Brand	CÓDIGO	DIÁMETRO	ESPEJOR
FIAT	TC-791-15 TC-791-MG	∅ 71.00mm ∅ 71.00mm	≅ 1.50mm ≅ 1.50mm
DESCRIPCIÓN / Descrição / Description			
MOBI - ARGO - UNO WAY 2017/... (55267849)			
MOTOR / Engine		CM3	HP ∅ PISTÓN
FIREFLY GSE N3		999	71 70.00

MARCA / Brand	CÓDIGO	DIÁMETRO	ESPEJOR
FORD	TC-860-15	∅ 89.00mm	≅ 1.50mm
DESCRIPCIÓN / Descrição / Description			
FOCUS 2016/... (5185441/CM5E6051DF/CP9Z6051D)			
MOTOR / Engine		CM3	HP ∅ PISTÓN
MGDA / XQDA		1999	170 / 150 87.50

JUNTAS CULATA DE CILINDROS (TC)

Modelos No incluídos en los Juegos Completos de Reparación

ILLINOIS



JUNTA DE CABEÇOTE Modelos não incluídos nos Jogo de Juntas do Motor
CYLINDER HEAD GASKET Models not included in Full Set Gasket

MARCA / Brand	CÓDIGO	DIÁMETRO	ESPEJOR
FORD	TC-698-07	Ø 102.20mm	≅ 1.30mm
DESCRIPCIÓN / Descrição / Description			
EXPLORER - RANGER - NAVAJO BRONCO II - AEROSTAR 1990/... (IZQUIERDA)(95TM6083AA)			
			
MOTOR / Engine	DIESEL	CM3	HP
244CID V6 SOHC 12V		3996	147/165
			Ø PISTÓN
			100.40

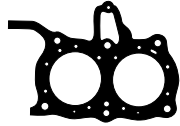
MARCA / Brand	CÓDIGO	DIÁMETRO	ESPEJOR
HONDA	TC-560-06	Ø 76.80mm	≅ 1.50mm
DESCRIPCIÓN / Descrição / Description			
ACTY 550 TA TB TN 1978/... CIVIC 2 CIL. (12251679004)			
			
MOTOR / Engine		CM3	HP
EH		545	31
			Ø PISTÓN
			72.00

MARCA / Brand	CÓDIGO	DIÁMETRO	ESPEJOR
FORD	TC-699-07	Ø 102.20mm	≅ 1.30mm
DESCRIPCIÓN / Descrição / Description			
EXPLORER - RANGER - NAVAJO BRONCO II - AEROSTAR 1990/... (DERECHA)(95TM6051AA)			
			
MOTOR / Engine	DIESEL	CM3	HP
244CID V6 SOHC 12V		3996	147/165
			Ø PISTÓN
			100.40

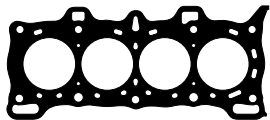
MARCA / Brand	CÓDIGO	DIÁMETRO	ESPEJOR
HONDA/ROVER	TC-837-07	Ø 76.00mm	≅ 1.60mm
DESCRIPCIÓN / Descrição / Description			
CIVIC COUPE/SI - BALLADE CRX ROVER: 213 1984/89 (12251PE0003)			
			
MOTOR / Engine		CM3	HP
EW1-EW2-EW3-EW4-EV-EV1-EV2		1200 1342 1488	80 100
			Ø PISTÓN
			74.00

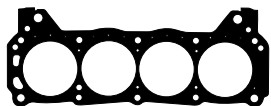
MARCA / Brand	CÓDIGO	DIÁMETRO	ESPEJOR
FORD	TC-439-06	Ø 103.50mm	≅ 1.50mm
DESCRIPCIÓN / Descrição / Description			
RANGER 100 1989/... - V8 1976/97 GALAXY - MAVERICK			
			
MOTOR / Engine		CM3	HP
F302 V8		4942	
			Ø PISTÓN
			101.60

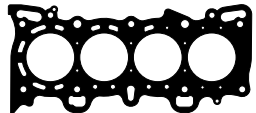
MARCA / Brand	CÓDIGO	DIÁMETRO	ESPEJOR
HONDA	TC-350-11	Ø 76.00mm	≅ 1.30mm
DESCRIPCIÓN / Descrição / Description			
ACCORD - CITY 1999/03 - CIVIC/VTEC/VTEC-E 1992/00 - CRX VTEC 1992/98 - HRV 1999/05 ROVER: 216 - 416 1992/94 ACURA: EL - OH 1622 2000/...			
			
MOTOR / Engine		CM3	HP
D1386/7/8 D14AZ D15Z D16B/W/Y/Z		1342 1396 1493 1590	95/65 75/90 101/114 105/125
			Ø PISTÓN
			75.00

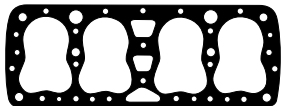
MARCA / Brand	CÓDIGO	DIÁMETRO	ESPEJOR
FORD	TC-236-01	Ø 80.00mm	≅ 1.92mm
DESCRIPCIÓN / Descrição / Description			
FORD 1932/37			
			
MOTOR / Engine		CM3	HP
			Ø PISTÓN

MARCA / Brand	CÓDIGO	DIÁMETRO	ESPEJOR
HONDA	TC-826-07	Ø 67.00mm	≅ 1.60mm
DESCRIPCIÓN / Descrição / Description			
FIT I (AA) 1983/86 - JAZZ I (AA) CITY BOX/HATCHBACK (12251PC0010)			
			
MOTOR / Engine		CM3	HP
ER1 - ER2 - ER4		1231	56 45 54
			Ø PISTÓN
			61.90

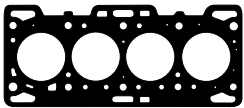
MARCA / Brand	CÓDIGO	DIÁMETRO	ESPEJOR
HAN JIAG	TC-108-06	Ø 64.50mm	≅ 1.40mm
DESCRIPCIÓN / Descrição / Description			
HAN JIAG 4 CIL.			
			
MOTOR / Engine		CM3	HP
			Ø PISTÓN

MARCA / Brand	CÓDIGO	DIÁMETRO	ESPEJOR
HONDA	TC-517-07	Ø 77.60mm	≅ 1.55mm
DESCRIPCIÓN / Descrição / Description			
ACCORD - PRELUDE 1978/83 VIGOR 1982/83 - QUINTET 1981/... (12251PB2000/689010) (12251689010/12251PC1000/020)			
			
MOTOR / Engine		CM3	HP
EP - EK - EL		1599 1602 1750	82 90 95/97
			Ø PISTÓN
			77.00

JUNTAS CULATA DE CILINDROS (TC)

Modelos No incluidos en los Juegos Completos de Reparación



JUNTA DE CABEÇOTE Modelos não incluídos nos Jogo de Juntas do Motor
CYLINDER HEAD GASKET Models not included in Full Set Gasket

MARCA / Brand	CÓDIGO	DIÁMETRO	ESPESOR
HONDA	TC-383-11	Ø 87.00mm	≅ 1.60mm
DESCRIPCIÓN / Descrição / Description			
ACCORD - CIVIC VI/VII VTEC 16V 2003/... CRV 2002/... - INTEGRA - STEPWAGON 2000/05 - STREAM 2001/... - ACURA: RSX 2002/06 (12251PNA004/12251PNC004/ 12251PPA004)			
MOTOR / Engine			
K20A1/3/4/5/9 K24A1	CM3	HP	Ø PISTÓN
	1998	150/155/160	86.00
	2350	170/200	86.00

MARCA / Brand	CÓDIGO	DIÁMETRO	ESPESOR
HYUNDAI	TC-321-11	Ø 88.00mm	≅ 0.75mm
DESCRIPCIÓN / Descrição / Description			
SONATA - KIA: MAGENTIS OPTIMA/EX/LX/SE 2001/06 (2231138200/2231138C00)			
MOTOR / Engine			
G4JS 16V SIRIUS II 16V	CM3	HP	Ø PISTÓN
	2350	136	86.50
	2350	149	86.50

MARCA / Brand	CÓDIGO	DIÁMETRO	ESPESOR
HYUNDAI	TC-940-07	Ø 72.30mm	≅ 1.40mm
DESCRIPCIÓN / Descrição / Description			
HB20 - PICANTO			
MOTOR / Engine			
KAPPA CVVT 12V	CM3	HP	Ø PISTÓN
	998	75/80	71.00

MARCA / Brand	CÓDIGO	DIÁMETRO	ESPESOR
HYUNDAI	TC-329-11	Ø 89.00mm	≅ 0.60mm
DESCRIPCIÓN / Descrição / Description			
TUCSON GL/GLS/LX/SE 2005/11 - COUPE - SANTA FE 2001/06 - SONATA - TIBURON - TRAJET 2000/09 - KIA: MAGENTIS - OPTIMA 2004/06 - SPORTAGE 2004/10 (2231137320) (DERECHA)			
MOTOR / Engine			
G6BA V6 24V G6BA-C V6 24V	CM3	HP	Ø PISTÓN
	2600	165/170/175	86.70
	2600	165	86.70

MARCA / Brand	CÓDIGO	DIÁMETRO	ESPESOR
HYUNDAI	TC-781-15	Ø 77.00mm	≅ 1.60mm
DESCRIPCIÓN / Descrição / Description			
PONY - ACCENT - SCOUPE - GETZ ELANTRA 1994/... (2231122120/22130)			
MOTOR / Engine			
G4K - G4N - G4EH - G4EK - GA EK 50HC 12V	CM3	HP	Ø PISTÓN
	1341	60/84	71.50
	1495	65/67	75.50

MARCA / Brand	CÓDIGO	DIÁMETRO	ESPESOR
HYUNDAI	TC-330-11	Ø 89.00mm	≅ 0.60mm
DESCRIPCIÓN / Descrição / Description			
TUCSON GL/GLS/LX/SE 2005/11 - COUPE - SANTA FE 2001/06 - SONATA - TIBURON - TRAJET 2000/09 - KIA: MAGENTIS - OPTIMA 2004/06 - SPORTAGE 2004/10 (2231137310) (IZQUIERDA)			
MOTOR / Engine			
G6BA V6 24V G6BA-C V6 24V	CM3	HP	Ø PISTÓN
	2600	165/170/175	86.70
	2600	165	86.70

MARCA / Brand	CÓDIGO	DIÁMETRO	ESPESOR
HYUNDAI	TC-958-15	Ø 77.50mm	≅ 1.00mm
DESCRIPCIÓN / Descrição / Description			
NEW ACCENT - GETZ - LANTRA - KIA: RIO (2231126101)			
MOTOR / Engine			
G4ED G4ED-G G4ED-L	CM3	HP	Ø PISTÓN
	1599	104	76.50
	1599	103	76.50
	1599	90	76.50

MARCA / Brand	CÓDIGO	DIÁMETRO	ESPESOR
INDENOR	TC-564-06	Ø 96.00mm	≅ 1.80mm
DESCRIPCIÓN / Descrição / Description			
6 CIL. PICK UP CAMIONES LIVIANOS 1976/... (7932564965)			
MOTOR / Engine			
XDP 6.90	DIESEL	CM3	HP
		3168	95
			90.00

MARCA / Brand	CÓDIGO	DIÁMETRO	ESPESOR
HYUNDAI	TC-351-11	Ø 79.50mm	≅ 0.80mm
DESCRIPCIÓN / Descrição / Description			
LANTRA - ELANTRA 1996/00 - COUPE 1997/00 (2231123100)			
MOTOR / Engine			
G4DR	CM3	HP	Ø PISTÓN
	1599	84/114	77.40

MARCA / Brand	CÓDIGO	DIÁMETRO	ESPESOR
ISUZU/OPEL	TC-602-20 1M TC-602-20 2M TC-602-20 3M	Ø 78.50mm Ø 78.50mm Ø 78.50mm	≅ 1.40mm ≅ 1.50mm ≅ 1.60mm
DESCRIPCIÓN / Descrição / Description			
I - MARK - GEMINI 1985/... OPEL: CORSA A/B - KADETTE 1984/99 (8943864430)(8941501940/2) (8944716200/1)			
MOTOR / Engine			
4EC1 - T4EC1 - 15D/T - X15D/T	DIESEL	CM3	HP
		1468	50
		1487	76
			76.00
			76.00

JUNTAS CULATA DE CILINDROS (TC)

Modelos No incluídos en los Juegos Completos de Reparación

ILLINOIS

MENÚ

JUNTA DE CABEÇOTE Modelos não incluídos nos Jogo de Juntas do Motor
CYLINDER HEAD GASKET Models not included in Full Set Gasket

MARCA / Brand	CÓDIGO	DIÁMETRO	ESPESOR
ISUZU	TC-129-15	∅ 83.00mm	≅ 1.50mm
DESCRIPCIÓN / Descrição / Description			
FARGO - TFR - TFS - WFR 1981/... (8942320971)(8970417670)			
			
MOTOR / Engine			
4ZA1	CM3	HP	∅ PISTÓN
	1584		82.00

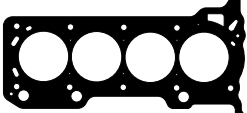
MARCA / Brand	CÓDIGO	DIÁMETRO	ESPESOR
JAC	TC-880-15 TC-880-MG	∅ 76.00mm ∅ 76.00mm	≅ 1.50mm ≅ 1.50mm
DESCRIPCIÓN / Descrição / Description			
J2 - J3 2011/...			
			
MOTOR / Engine			
HFC4EB1.3D 16V	CM3	HP	∅ PISTÓN
	1332	91	75.00

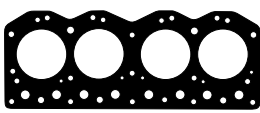
MARCA / Brand	CÓDIGO	DIÁMETRO	ESPESOR
ISUZU	TC-569-07	∅ 87.40mm	≅ 2.00mm
DESCRIPCIÓN / Descrição / Description			
ELF 150/250 - PICK UP - FASTER FLORIAN - TRACTOR 1968/... (5111410172)			
			
MOTOR / Engine			
C190 - C240	DIESEL	CM3	HP
		1951	62
		2369	92
			86.00
			86.00

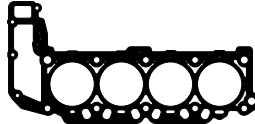
MARCA / Brand	CÓDIGO	DIÁMETRO	ESPESOR
JEEP	TC-944-07	∅ 93.50mm	≅ 1.50mm
DESCRIPCIÓN / Descrição / Description			
GRAND CHEROKEE - LIBERTY 2002/... DODGE DAKOTA - RAM 2500 2002/... (53020673AC)			
			
MOTOR / Engine			
EVA V8 16V	CM3	HP	∅ PISTÓN
		4701	235
EVC V8 16V		4701	235
			93.00
			93.00

MARCA / Brand	CÓDIGO	DIÁMETRO	ESPESOR
ISUZU	TC-866-07	∅ 89.00mm	≅ 1.60mm
DESCRIPCIÓN / Descrição / Description			
FARGO 2200 WFS 1987/... (8941248800)			
			
MOTOR / Engine			
4FD1	DIESEL	CM3	HP
		2189	61
4FG1		2380	74
			88.00
			88.00

MARCA / Brand	CÓDIGO	DIÁMETRO	ESPESOR
KIA	TC-814-20 TC-814-MG	∅ 92.50mm ∅ 92.50mm	≅ 1.50mm ≅ 1.50mm
DESCRIPCIÓN / Descrição / Description			
SORENTO GRDI HYUNDAI: H1 2002/... (223114A010)			
			
MOTOR / Engine			
D4CB 16V	DIESEL	CM3	HP
		2497	110/140
			91.00

MARCA / Brand	CÓDIGO	DIÁMETRO	ESPESOR
ISUZU	TC-391-07	∅ 89.00mm	≅ 1.65mm
DESCRIPCIÓN / Descrição / Description			
FASTER PICK UP 1981/84 JEEP 1982/... CHEVROLET: CAMPO PICK UP LUV S10/15 LUV S11/12 1981/82 (5111410671/5111410821/ 94030188)			
			
MOTOR / Engine			
C223	DIESEL	CM3	HP
		2237	73
			88.00

MARCA / Brand	CÓDIGO	DIÁMETRO	ESPESOR
KIA	TC-836-20	∅ 98.00mm	≅ 1.40mm
DESCRIPCIÓN / Descrição / Description			
BESTA 1993/...			
			
MOTOR / Engine			
VN	DIESEL	CM3	HP
		2700	81
			96.00

MARCA / Brand	CÓDIGO	DIÁMETRO	ESPESOR
ISUZU	TC-393-07	∅ 94.50mm	≅ 1.90mm
DESCRIPCIÓN / Descrição / Description			
AMIGO - PICK UP /S/LS/XS 1988/95 RODEO /S/LS/XS 1991/95 - TROOPER II 1986/91			
			
MOTOR / Engine			
4ZE1	CM3	HP	∅ PISTÓN
		2555	116/ 122
			92.60

MARCA / Brand	CÓDIGO	DIÁMETRO	ESPESOR
LADA	TC-123-15	∅ 84.00mm	≅ 1.60mm
DESCRIPCIÓN / Descrição / Description			
SAGONA - SAMARA - ALEKO VAZ21083/21093 - FORMAN 1985/... (210831003020)			
			
MOTOR / Engine			
OHC	CM3	HP	∅ PISTÓN
		1499	70/77
			82.00

JUNTAS CULATA DE CILINDROS (TC)

Modelos No incluidos en los Juegos Completos de Reparación

JUNTA DE CABEÇOTE Modelos não incluídos nos Jogo de Juntas do Motor
CYLINDER HEAD GASKET Models not included in Full Set Gasket

MARCA / Brand	CÓDIGO	DIÁMETRO	ESPESOR
LISTER	TC-309-01	∅ 117.50mm	≅ 1.90mm
	TC-309-15	∅ 117.50mm	≅ 1.80mm
DESCRIPCIÓN / Descrição / Description			
1 CIL. 5 - 6 HP			
MOTOR / Engine		CM3	HP
			∅ PISTÓN
			5/6

MARCA / Brand	CÓDIGO	DIÁMETRO	ESPESOR
MAZDA	TC-323-11	∅ 79.50mm	≅ 0.60mm
DESCRIPCIÓN / Descrição / Description			
3/2 2003/... (ZY0110271)			
MOTOR / Engine		CM3	HP
DE5 16V			∅ PISTÓN
LF 16V		1498	103
Z6 16V		1598	105
			78.00

MARCA / Brand	CÓDIGO	DIÁMETRO	ESPESOR
MAZDA	TC-735-07	∅ 72.70mm	≅ 1.50mm
DESCRIPCIÓN / Descrição / Description			
LASER - FESTIVA - KIA: PRIDE 91/... MAZDA: 323 - 121 - FAMILIA (KVO310271/B30110271)			
MOTOR / Engine		CM3	HP
OHC / B3			∅ PISTÓN
		1323	59/67
			71.00

MARCA / Brand	CÓDIGO	DIÁMETRO	ESPESOR
MAZDA	TC-794-15	∅ 80.00mm	≅ 1.60mm
DESCRIPCIÓN / Descrição / Description			
ALLEGRO (B6DC10271)			
MOTOR / Engine		CM3	HP
B6ZE - B6D			∅ PISTÓN
		1597	90/110
			78.00

MARCA / Brand	CÓDIGO	DIÁMETRO	ESPESOR
MAZDA	TC-844-07	∅ 73.50mm	≅ 1.80mm
DESCRIPCIÓN / Descrição / Description			
FESTIVA 1988/93 - KIA: PRIDE 1991/93 - MAZDA: FAMILIA - 323 - 121 1987/91 (B30210271)			
MOTOR / Engine		CM3	HP
B3 DOHC			∅ PISTÓN
		1323	60/66
			71.00

MARCA / Brand	CÓDIGO	DIÁMETRO	ESPESOR
MAZDA	TC-340-20	∅ 80.00mm	≅ 1.60mm
MAZDA	TC-340-MG	∅ 80.00mm	≅ 1.60mm
DESCRIPCIÓN / Descrição / Description			
323 FAMILIA 1986/94			
MOTOR / Engine		DIESEL	CM3
PN B6			HP
			∅ PISTÓN
		1720	55
			78.00

MARCA / Brand	CÓDIGO	DIÁMETRO	ESPESOR
MAZDA	TC-737-07	∅ 80.50mm	≅ 1.50mm
DESCRIPCIÓN / Descrição / Description			
TRACER - MERCURY - MAZDA: 323 - FAMILIA - LASER - ETUDE 1987/... (B63010271/A/C/B61610271)			
MOTOR / Engine		CM3	HP
B5			∅ PISTÓN
B6		1498	72
		1597	101/105
			78.00

MARCA / Brand	CÓDIGO	DIÁMETRO	ESPESOR
MAZDA	TC-495-07	∅ 82.00mm	≅ 1.50mm
DESCRIPCIÓN / Descrição / Description			
121 - 626 - 616 - 929 - B2000 COSMO - CAPELLA - LUCE 1973/84 FORD: COURIER 1979/82 (045310271/A)			
MOTOR / Engine		CM3	HP
MA-VC			∅ PISTÓN
		1769	100
		1970	110
			80.00

MARCA / Brand	CÓDIGO	DIÁMETRO	ESPESOR
MAZDA	TC-755-07	∅ 80.00mm	≅ 1.50mm
DESCRIPCIÓN / Descrição / Description			
SEPHIA - LEO - MENTOR 1994/... - MAZDA: FAMILIA - LASER - 323 - MX3 1987/... (B61L10271)			
MOTOR / Engine		CM3	HP
B5 - B6 - B6E - B6ZE 16V			∅ PISTÓN
		1498	80
		1597	81/88
			78.00

MARCA / Brand	CÓDIGO	DIÁMETRO	ESPESOR
MAZDA/KIA/ASIA	TC-496-15	∅ 88.50mm	≅ 1.60mm
DESCRIPCIÓN / Descrição / Description			
CAPELLA - 626 - 929 - E1800 - E2000 - B2000 FORKLIFT - B2200 - MX6 - TELSTER 1982/... ASIA: ROCSTA 1994/... - KIA: SPORTAGE 1995/99 FORD: PROBE 1989/92 (F20210271) (F80110271)			
MOTOR / Engine		CM3	HP
F8 - FE - F2 - F2L			∅ PISTÓN
		1789	83
		1998	147
		2184	86.00

JUNTAS CULATA DE CILINDROS (TC)

Modelos No incluídos en los Juegos Completos de Reparación

JUNTA DE CABEÇOTE Modelos não incluídos nos Jogo de Juntas do Motor
CYLINDER HEAD GASKET Models not included in Full Set Gasket

ILLINOIS

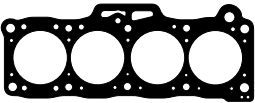

MARCA / Brand	CÓDIGO	DIÁMETRO	ESPESOR
MAZDA/KIA/FORD	TC-812-15	Ø 88.00mm	≅ 1.60mm
DESCRIPCIÓN / Descrição / Description			
CAPELLA - B2200 - E1800 - E2200 626 - 929 - MX6 /TURBO - BT50 KIA: SPORTAGE - ASIA: ROCSTA FORD: RANGER - PROBE/TURBO			
			
MOTOR / Engine		CM3	HP
F8 - FE - F2		1789 1998 2184	83 82/109 147
		Ø PISTÓN	86.00

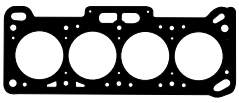
MARCA / Brand	CÓDIGO	DIÁMETRO	ESPESOR
MITSUBISHI	TC-115-07	Ø 76.90mm	≅ 1.50mm
DESCRIPCIÓN / Descrição / Description			
LANCER - MIRAGE - PROTON SAGA PERSONA - ISWARA - WIRA 1988/... COLT - SATRIA (MD323473)			
			
MOTOR / Engine		CM3	HP
G13B - G15B		1298 1468	74 90
		Ø PISTÓN	71.00 75.50

MARCA / Brand	CÓDIGO	DIÁMETRO	ESPESOR
MAZDA/FORD	TC-119-06	Ø 87.20mm	≅ 1.80mm
DESCRIPCIÓN / Descrição / Description			
CAPELLA - 626 1982/94 FORD: ESCORT - TEMPO ECONOVAN 1984/... (RF0310271)			
			
MOTOR / Engine		CM3	HP
RF/D2		1998	56/64
		Ø PISTÓN	86.00

MARCA / Brand	CÓDIGO	DIÁMETRO	ESPESOR
MITSUBISHI	TC-878-15	Ø 77.00mm	≅ 1.20mm
DESCRIPCIÓN / Descrição / Description			
COLT - LANCER 1996/2001- VARICA CARISMA 1995/... - MIRAGE 2002/... (MD331145)			
			
MOTOR / Engine		CM3	HP
4G13 - 4G15		1298 1497	55
		Ø PISTÓN	71.00 75.50

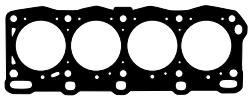
MARCA / Brand	CÓDIGO	DIÁMETRO	ESPESOR
MAZDA	TC-120-20	Ø 87.50mm	≅ 1.60mm
DESCRIPCIÓN / Descrição / Description			
E2000 - 626 - CAPELLA E/B2200 KIA: BESTA - BONGO - CERES .../1987 ASIA: ROCSTA (0K77010271/ R20210271/R20110271A/D/E)			
			
MOTOR / Engine		CM3	HP
RF CX HW R2		1998 2184	65/75/82 64/72
		Ø PISTÓN	86.00 86.00

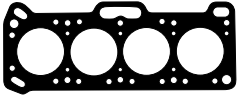
MARCA / Brand	CÓDIGO	DIÁMETRO	ESPESOR
MITSUBISHI/HYUNDAI	TC-482-15	Ø 77.00mm	≅ 1.60mm
DESCRIPCIÓN / Descrição / Description			
COLT 1979/82 SOHC - LANCER CORDIA 1978/86 - CHRYSLER: CHAMP HYUNDAI: EXCEL - MIRAGE - TREDIA LANTRA - PONY 1985/86 (MD030293) (2231121010/100)			
			
MOTOR / Engine		CM3	HP
4G12/T - G12B 4G15 - G15B - G4DJ		1410 1468	68/105 69/70
		Ø PISTÓN	74.00 75.50

MARCA / Brand	CÓDIGO	DIÁMETRO	ESPESOR
MITSUBISHI	TC-915-07	Ø 71.00mm	≅ --,--mm
DESCRIPCIÓN / Descrição / Description			
COLT - LANCER 1977/... MIRAGE 1979/83 (MD030290/MD181369)			
			
MOTOR / Engine		CM3	HP
4G11 G11B		1244 1244	55 54
		Ø PISTÓN	69.50 69.50

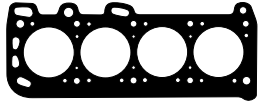
MARCA / Brand	CÓDIGO	DIÁMETRO	ESPESOR
MITSUBISHI	TC-472-07	Ø 78.70mm	≅ 1.60mm
DESCRIPCIÓN / Descrição / Description			
L200 - LANCER - SAPPORO - GALANT CELESTE - LAMBA - SIGMA 1978/... CHRYSLER: ARROW - CHALLENGER COLT - CHAMP (MD007515/8766/9451)			
			
MOTOR / Engine		CM3	HP
4G32 - G32B		1597	86/100
		Ø PISTÓN	77.00

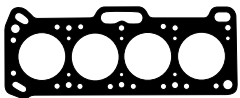
MARCA / Brand	CÓDIGO	DIÁMETRO	ESPESOR
MITSUBISHI/HYUNDAI	TC-485-06	Ø 73.90mm	≅ 1.50mm
DESCRIPCIÓN / Descrição / Description			
COLT - LANCER - MIRAGE 1977/... HYUNDAI: PONY 1983/85 (MD030290)			
			
MOTOR / Engine		CM3	HP
G11B G4AG		1244 1298	72 87
		Ø PISTÓN	69.50 69.50

MARCA / Brand	CÓDIGO	DIÁMETRO	ESPESOR
MITSUBISHI	TC-757-07	Ø 81.00mm	≅ 1.60mm
DESCRIPCIÓN / Descrição / Description			
LANCER - COLT - GALANT - CELESTE SAPPORO 1975/80 (MD000437)			
			
MOTOR / Engine		CM3	HP
4G32		1597	100
		Ø PISTÓN	77.00

JUNTAS CULATA DE CILINDROS (TC)

Modelos No incluidos en los Juegos Completos de Reparación



JUNTA DE CABEÇOTE Modelos não incluídos nos Jogo de Juntas do Motor
CYLINDER HEAD GASKET Models not included in Full Set Gasket

MARCA / Brand	CÓDIGO	DIÁMETRO	ESPEJOR
MITSUBISHI	TC-833-07	∅ 82.50mm	≅ 1.20mm
DESCRIPCIÓN / Descrição / Description			
LANCER CARISMA COLT 16V 1992/... SPACE WAGON /RUNNER - GALANT ETERNA - MIRAGE 1991/... SOHC (MD184399)			
MOTOR / Engine		CM3	HP
4G91/4G92/4G93/K		1597 1834	100 103 113/140
		∅ PISTÓN	81.00

MARCA / Brand	CÓDIGO	DIÁMETRO	ESPEJOR
NISSAN	TC-862-07	∅ 77.50mm	≅ 1.40mm
DESCRIPCIÓN / Descrição / Description			
SUNNY - CHERRY - VANETTE - B310 1974/... - FORKLIFT 1985/... (11044H7200)			
MOTOR / Engine		CM3	HP
A14S A15/A15S		1397 1487	80 73/85
		∅ PISTÓN	76.00 76.00

MARCA / Brand	CÓDIGO	DIÁMETRO	ESPEJOR
MITSUBISHI	TC-834-07	∅ 87.20mm	≅ 1.60mm
DESCRIPCIÓN / Descrição / Description			
ETERNA - SAVA - DELICA - L200 L300 - L400 - SAPAGE GEAR 1994/... SPACE WAGON - GALANT 1992/99			
MOTOR / Engine		CM3	HP
4G63/B 4G63K/4G67		1836 1997	133 136
		∅ PISTÓN	85.00

MARCA / Brand	CÓDIGO	DIÁMETRO	ESPEJOR
NISSAN	TC-865-07	∅ 76.00mm	≅ 1.60mm
DESCRIPCIÓN / Descrição / Description			
SUNNY - PULSAR 12V 1988/... ISUZU: TRUCK - LV 12V 1988/... (110487A00)			
MOTOR / Engine		CM3	HP
GA14S GA15E		1392 1497	79 97
		∅ PISTÓN	73.60 73.60

MARCA / Brand	CÓDIGO	DIÁMETRO	ESPEJOR
MITSUBISHI	TC-811-15	∅ 93.00mm	≅ 1.50mm
DESCRIPCIÓN / Descrição / Description			
LEBARON - RAIDER - NEW YORKER - CARAVELLE RAM 50 - COUNTRY - VOYAGER CARAVAN - 400 - 600 1981/89 - MITSUBISHI: SAPPORO - SHOGUN - SIGMA MONTERO - S - SP - SPX - PAJERO - L200 1983/97 - STARION 1983/... MAZDA: B2600 1987/94 (MD026654/MD110383)			
MOTOR / Engine		CM3	HP
G54B - 4G54 - 4G54B - AM		2555	103/155
		∅ PISTÓN	91.10

MARCA / Brand	CÓDIGO	DIÁMETRO	ESPEJOR
NISSAN	TC-858-07	∅ -----	≅ 1.20mm
DESCRIPCIÓN / Descrição / Description			
HOMER CABSTAR F20 - TRUCK HOMY - CARAVAN - SEDAN - GUAYIN PICK UP - ESTAQUILLAS 1970/... (11044B9500)			
MOTOR / Engine		CM3	HP
J15 J16		1483 1567	77 80
		∅ PISTÓN	78.00

MARCA / Brand	CÓDIGO	DIÁMETRO	ESPEJOR
NISSAN	TC-857-07	∅ -----	≅ 1.15mm
DESCRIPCIÓN / Descrição / Description			
SUNNY CHERRY 1966/75 (11044H1000)			
MOTOR / Engine		CM3	HP
A10 A12		998 1171	58 68
		∅ PISTÓN	73.00

MARCA / Brand	CÓDIGO	DIÁMETRO	ESPEJOR
NISSAN	TC-733-15	∅ 78.50mm	≅ 1.60mm
DESCRIPCIÓN / Descrição / Description			
SENTRA - SUNNY - PULSAR - TSURU VANETTE - ALMERA - PRIMERA - 200SX TSUBAME - LUCINO - SERENA INY. 1990/.. (1104457Y00/0M600/10/200)			
MOTOR / Engine		CM3	HP
GA16/DE/DS/DNE/GE DOHC 16V		1597	97/110
		∅ PISTÓN	76.00

MARCA / Brand	CÓDIGO	DIÁMETRO	ESPEJOR
NISSAN	TC-859-15	∅ 78.20mm	≅ 1.20mm
DESCRIPCIÓN / Descrição / Description			
SUNNY B11 - PULSAR - SENTRA LANGREY 1980/84 - TSURU - SEDAN SAMURAI - NINJA - GAYIN 1984/94 (1104401M02)			
MOTOR / Engine		CM3	HP
E13S E15/E15S/E16/E16S		1270 1485 1597	75/85
		∅ PISTÓN	76.00

MARCA / Brand	CÓDIGO	DIÁMETRO	ESPEJOR
NISSAN	TC-863-07	∅ 80.00mm	≅ 1.20mm
DESCRIPCIÓN / Descrição / Description			
STANZA T11 - AUSTER - LIBERTA SILVIA - VIOLET 1980/84 - BLUEBIRD 1983/... (11044D0100/1/2/3)			
MOTOR / Engine		CM3	HP
CA16/S/D		1598	90
		∅ PISTÓN	78.00

JUNTAS CULATA DE CILINDROS (TC)

Modelos No incluidos en los Juegos Completos de Reparación

ILLINOIS



JUNTA DE CABEÇOTE Modelos não incluídos nos Jogo de Juntas do Motor
CYLINDER HEAD GASKET Models not included in Full Set Gasket

MARCA / Brand	CÓDIGO	DIÁMETRO	ESPEJOR
NISSAN	TC-489-07	∅ 86.00mm	≠ 1.40mm
DESCRIPCIÓN / Descrição / Description			
BLUEBIRD - VIOLET - SKYLINE - STANZA 180 - 200SX - 510 - 521 - 610 - 620 710 - 720 - 910 - SILVIA - LAUREL 1968/... (11044U0800/03/11/A8702)			
MOTOR / Engine			
L16 - L18/S/T - L20B	CM3	HP	∅ PISTÓN
	1597	100	83.00
	1770	105/110	85.00
	1952		

MARCA / Brand	CÓDIGO	DIÁMETRO	ESPEJOR
NISSAN	TC-951-07	∅ 89.00mm	≠ 1.60mm
DESCRIPCIÓN / Descrição / Description			
X TRAIL - ALTIMA 2002/... SENTRA 2003/... (110446N201/8J022/6)			
MOTOR / Engine			
QR25DE 16V	CM3	HP	∅ PISTÓN
	2488	165/177	89.00

MARCA / Brand	CÓDIGO	DIÁMETRO	ESPEJOR
NISSAN	TC-127-20 0M TC-127-20 1M TC-127-20 2M	∅ 81.00mm ∅ 81.00mm ∅ 81.00mm	≠ 1.40mm ≠ 1.50mm ≠ 1.60mm
DESCRIPCIÓN / Descrição / Description			
SENTRA - SUNNY - CHERRY PULSAR 1982/... (1104454A02/16A00/01/02/05/06/07)			
MOTOR / Engine			
CD17	DIESEL CM3	HP	∅ PISTÓN
	1680	54/61	80.00

MARCA / Brand	CÓDIGO	DIÁMETRO	ESPEJOR
NISSAN	TC-590-06	∅ -----	≠ 1.60mm
DESCRIPCIÓN / Descrição / Description			
CEDRIC - FAIRLADY - LAUREL PATROL - 280Z 1975/... (11044N4200/10/20)			
MOTOR / Engine			
L28S	CM3	HP	∅ PISTÓN
	2753	121/140	86.00

MARCA / Brand	CÓDIGO	DIÁMETRO	ESPEJOR
NISSAN	TC-545-07	∅ 86.90mm	≠ 1.50mm
DESCRIPCIÓN / Descrição / Description			
BLUEBIRD - VANETTE TRADE 1980/... (11044W1700)			
MOTOR / Engine			
LD20/E	DIESEL CM3	HP	∅ PISTÓN
	1952	58/60	85.00

MARCA / Brand	CÓDIGO	DIÁMETRO	ESPEJOR
NISSAN	TC-546-06	∅ 86.40mm	≠ 1.50mm
DESCRIPCIÓN / Descrição / Description			
LAUREL - CEDRIC - MAXIMA - 810 280C - SKYLINE - BLUEBIRD 1980/... (11044W2500/01/02/V0700)			
MOTOR / Engine			
LD28	DIESEL CM3	HP	∅ PISTÓN
	2793	84	84.50

MARCA / Brand	CÓDIGO	DIÁMETRO	ESPEJOR
NISSAN	TC-864-07	∅ 86.00mm	≠ 1.20mm
DESCRIPCIÓN / Descrição / Description			
BLUEBIRD - VANETTE - TRADE SERENA 1985/... (1104413C00)			
MOTOR / Engine			
LD20 II/C22/LD20T/LD20E	DIESEL CM3	HP	∅ PISTÓN
	1952	58/79	85.00

MARCA / Brand	CÓDIGO	DIÁMETRO	ESPEJOR
NISSAN	TC-909-11	∅ 86.00mm	≠ 2.00mm
DESCRIPCIÓN / Descrição / Description			
PATROL 1989/00 - SAFARI 1997/... (1104422J10/11044VB300)			
MOTOR / Engine			
RD28 / RD28T	DIESEL CM3	HP	∅ PISTÓN
	2826	101/129	85.00

MARCA / Brand	CÓDIGO	DIÁMETRO	ESPEJOR
NISSAN	TC-163-20 1M TC-163-20 2M TC-163-20 3M TC-163-MG 1M TC-163-MG 2M TC-163-MG 3M	∅ 86.00mm ∅ 86.00mm ∅ 86.00mm ∅ 86.00mm ∅ 86.00mm ∅ 86.00mm	≠ 1.20mm ≠ 1.30mm ≠ 1.40mm ≠ 1.20mm ≠ 1.30mm ≠ 1.40mm
DESCRIPCIÓN / Descrição / Description			
PRIMERA - PULSAR - ALMERA SUNNY - AVENIR - VANETTE 1997/98 (110440C400/01/02/03)			
MOTOR / Engine			
CD20	DIESEL CM3	HP	∅ PISTÓN
	1974	75	84.50

MARCA / Brand	CÓDIGO	DIÁMETRO	ESPEJOR
NISSAN	TC-578-06	∅ 107.80mm	≠ 1.55mm
DESCRIPCIÓN / Descrição / Description			
CIVILIAN BUS - CLIPPER C240 - 340 - 341 1973/... (11044J2000/J5500/03)			
MOTOR / Engine			
ED30	DIESEL CM3	HP	∅ PISTÓN
	2956	76	

JUNTAS CULATA DE CILINDROS (TC)

Modelos No incluidos en los Juegos Completos de Reparación



JUNTA DE CABEÇOTE Modelos não incluídos nos Jogo de Juntas do Motor
CYLINDER HEAD GASKET Models not included in Full Set Gasket

MARCA / Brand	CÓDIGO	DIÁMETRO	ESPESOR	
NISSAN	TC-336-11	Ø 100.00mm	≅ 1.50mm	
DESCRIPCIÓN / Descrição / Description				
FRONTIER (110441W400/110441W402)				
MOTOR / Engine		CM3	HP	Ø PISTÓN
QD32		3100	103	99.20

MARCA / Brand	CÓDIGO	DIÁMETRO	ESPESOR	
SMART	TC-920-15 TC-920-MG	Ø 73.00mm Ø 73.00mm	≅ 1.50mm ≅ 1.50mm	
DESCRIPCIÓN / Descrição / Description				
FORTWO 2007/... (1320160020)				
MOTOR / Engine		CM3	HP	Ø PISTÓN
M132.930		999	84	72.00

MARCA / Brand	CÓDIGO	DIÁMETRO	ESPESOR	
PIAGGIO	TC-121-06 1M	Ø 73.30mm	≅ 1.60mm	
DESCRIPCIÓN / Descrição / Description				
PORTER 1994/...				
MOTOR / Engine		CM3	HP	Ø PISTÓN
ECO		1221	36	72.00

MARCA / Brand	CÓDIGO	DIÁMETRO	ESPESOR	
SUBARU	TC-475-07	Ø 94.50mm	≅ 1.40mm	
DESCRIPCIÓN / Descrição / Description				
LEONE - BRAT MV PICK UP 2 CIL. 1979/93 (412307102/12/22)				
MOTOR / Engine		CM3	HP	Ø PISTÓN
EA71		1595	71/87	92.00

MARCA / Brand	CÓDIGO	DIÁMETRO	ESPESOR	
RENAULT	TC-786-15 TC-786-MG	Ø 73.00mm Ø 73.00mm	≅ 1.00mm ≅ 1.00mm	
DESCRIPCIÓN / Descrição / Description				
KWID 2017/... - LOGAN II SANDERO II 2016/... (110442970R)				
MOTOR / Engine		CM3	HP	Ø PISTÓN
B4D 12V		999	82	71.00

MARCA / Brand	CÓDIGO	DIÁMETRO	ESPESOR	
SUBARU	TC-835-07	Ø 93.00mm	≅ 1.50mm	
DESCRIPCIÓN / Descrição / Description				
LEONE - LOYALE TURBO - RXGL - XT MV 1985/94 (11044AA001/3/11)				
MOTOR / Engine		CM3	HP	Ø PISTÓN
EA82/T-EA85		1781	90/136	92.00

MARCA / Brand	CÓDIGO	DIÁMETRO	ESPESOR	
RENAULT	TC-335-15	Ø 81.00mm	≅ 1.60mm	
DESCRIPCIÓN / Descrição / Description				
R12 - R15 - R16 - R17 - R18 - R20 FUEGO - TRAFIC 1972/... (7701457060/7701460708)				
MOTOR / Engine		CM3	HP	Ø PISTÓN
841 - 843 - A2M23		1647	65/79	79.00

MARCA / Brand	CÓDIGO	DIÁMETRO	ESPESOR	
SUZUKI	TC-840-07	Ø -----	≅ 1.30mm	
DESCRIPCIÓN / Descrição / Description				
ALTO (1114184410)				
MOTOR / Engine		CM3	HP	Ø PISTÓN
F8D		796	47	68.50

MARCA / Brand	CÓDIGO	DIÁMETRO	ESPESOR	
SKODA	TC-874-07	Ø 75.50mm	≅ 1.60mm	
DESCRIPCIÓN / Descrição / Description				
FAVORIT - FELICIA - FORMAN 1989/96 (77105407)				
MOTOR / Engine		CM3	HP	Ø PISTÓN
115/135/136		1289	50/55/62	75.50

MARCA / Brand	CÓDIGO	DIÁMETRO	ESPESOR	
SUZUKI	TC-779-07	Ø 70.00mm	≅ 1.60mm	
DESCRIPCIÓN / Descrição / Description				
MARUTI - ALTO - A-STAR CELERIO - FRONTE (11141M53M00)				
MOTOR / Engine		CM3	HP	Ø PISTÓN
F8DN		796	35	68.50

JUNTAS CULATA DE CILINDROS (TC)

Modelos No incluídos en los Juegos Completos de Reparación

ILLINOIS

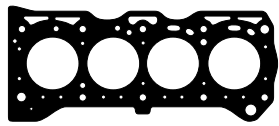

JUNTA DE CABEÇOTE Modelos não incluídos nos Jogo de Juntas do Motor
CYLINDER HEAD GASKET Models not included in Full Set Gasket

MARCA / Brand	CÓDIGO	DIÁMETRO	ESPESOR
SUZUKI	TC-841-07	Ø 73.00mm	≅ 1.30mm
DESCRIPCIÓN / Descrição / Description			
ZEN NEW ALTO 1994/2002 (1114172F10)			
			
MOTOR / Engine		CM3	HP
YE2 - G10B		993	54
		Ø PISTÓN 72.00	

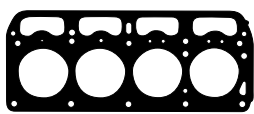
MARCA / Brand	CÓDIGO	DIÁMETRO	ESPESOR
TOYOTA/DAIHATSU	TC-477-07	Ø 77.50mm	≅ 1.60mm
DESCRIPCIÓN / Descrição / Description			
COROLLA - STARLET - LITEACE SPRINTER - TOWNACE 1977/... DAIHATSU: CHARMANT CONSORTE (1111513030/31)			
			
MOTOR / Engine		CM3	HP
3K/U/J - 4K - 4KU		1166	64
		Ø PISTÓN 75.00	
		1290 74 75.00	

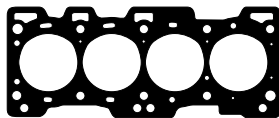
MARCA / Brand	CÓDIGO	DIÁMETRO	ESPESOR
SUZUKI	TC-842-07	Ø -----	≅ 1.30mm
DESCRIPCIÓN / Descrição / Description			
WAGON R (1114179F10)			
			
MOTOR / Engine		CM3	HP
F10D		1061	62
		Ø PISTÓN 68.50	

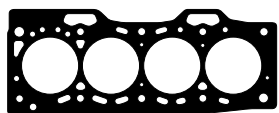
MARCA / Brand	CÓDIGO	DIÁMETRO	ESPESOR
TOYOTA	TC-849-07	Ø 74.00mm	≅ 1.40mm
DESCRIPCIÓN / Descrição / Description			
STARLET - COROLLA 12V 1984/96 TERCEL 1986... (1111511010/60)			
			
MOTOR / Engine		CM3	HP
2E - 2E-E/L/U/C/E/LC		1295	75/82
		Ø PISTÓN 73.00	
		1456 83 73.00	

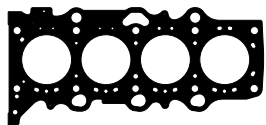
MARCA / Brand	CÓDIGO	DIÁMETRO	ESPESOR
SUZUKI	TC-339-11	Ø 79.00mm	≅ 1.20mm
DESCRIPCIÓN / Descrição / Description			
GRAND VITARA - IGNIS /II 2000/08 - JIMNY 2001/02 - LIANA 2001/03 - SWIFT /III 2005/... (1114169G01/1114169G03)			
			
MOTOR / Engine		CM3	HP
M13A 16V		1324	82/83/90/92
M15A 16V		1490	101
M16A 16V		1586	103/106
		Ø PISTÓN 78.00	
		78.00	
		78.00	

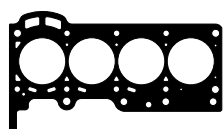
MARCA / Brand	CÓDIGO	DIÁMETRO	ESPESOR
TOYOTA	TC-345-11	Ø 73.50mm	≅ 0.50mm
DESCRIPCIÓN / Descrição / Description			
BELTA - YARIS 2002/... DAIHATSU: SIRION - TERIOS - YRV MINISTAR 2000/05 TOWNER 2000/05			
			
MOTOR / Engine		CM3	HP
2SZ-FE 16V		1298	87
K3-VE/VET 16V		1298	84/102/140
		Ø PISTÓN 72.00	
		72.00	

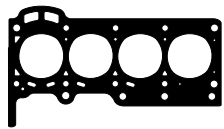
MARCA / Brand	CÓDIGO	DIÁMETRO	ESPESOR
TOYOTA	TC-341-11	Ø 71.00mm	≅ 0.60mm
DESCRIPCIÓN / Descrição / Description			
VITZ 1998/... - ECHO 1999/05 YARIS 1999/... (1111523030)			
			
MOTOR / Engine		CM3	HP
1SZ-FE		998	68
		Ø PISTÓN 69.00	

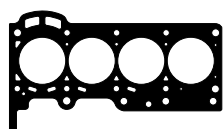
MARCA / Brand	CÓDIGO	DIÁMETRO	ESPESOR
TOYOTA	TC-344-11	Ø 73.00mm	≅ 0.45mm
DESCRIPCIÓN / Descrição / Description			
AVANZA - AVANZADA 2006/... RUSH 2008/09 - DAIHATSU: MATERIA PRISMA 2006/... - SIRION MINISTAR 2008/... - TERIOS 2005/...			
			
MOTOR / Engine		CM3	HP
K3-VE		1298	90
3SZ-VE		1495	103/105/109
		Ø PISTÓN 72.00	
		72.00	

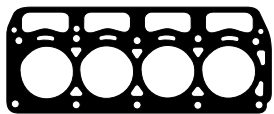
MARCA / Brand	CÓDIGO	DIÁMETRO	ESPESOR
TOYOTA/DAIHATSU	TC-847-07	Ø 77.00mm	≅ 1.40mm
DESCRIPCIÓN / Descrição / Description			
COROLLA - STARLET - PUBLICA 1967/77 - KE30/40/45/60 - SPRINTER DAIHATSU: CHARMANT 1975/77 (1111524013)			
			
MOTOR / Engine		CM3	HP
3K - H/3K - U/3K - J - K - 3KC		1077	64/68
		Ø PISTÓN 75.00	
		1166	

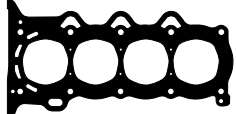
MARCA / Brand	CÓDIGO	DIÁMETRO	ESPESOR
TOYOTA	TC-382-11	Ø 76.00mm	≅ 0.50mm
DESCRIPCIÓN / Descrição / Description			
COROLLA - ECHO /VERSO 1998/2005 AVANZA 1999/... - PLATZ 2002/2005 - PRIUS 1999/2009 - SOLUNA VIOS 2003/07 - VIOS 2003/05 - VITZ 1998/01 YARIS 1998/05 (1111521030/1111521050)			
			
MOTOR / Engine		CM3	HP
2NZ-FE		1298	85/87
1NZ-FE/FXE		1497	106
		Ø PISTÓN 75.00	
		75.00	

JUNTAS CULATA DE CILINDROS (TC)

Modelos No incluidos en los Juegos Completos de Reparación



JUNTA DE CABEÇOTE Modelos não incluídos nos Jogo de Juntas do Motor
CYLINDER HEAD GASKET Models not included in Full Set Gasket

MARCA / Brand	CÓDIGO	DIÁMETRO	ESPESOR
TOYOTA	TC-900-07	∅ 75.50mm	≅ ---mm
DESCRIPCIÓN / Descrição / Description			
COROLLA 1990/97 - TERCEL 1990/95 PASEO 1990/95 - STARLET 1990/99 (1111511070/71/80)			
MOTOR / Engine		CM3	HP
4E-FE		1332	75
5E-FE		1497	90
		∅ PISTÓN	
			74.00
			74.00

MARCA / Brand	CÓDIGO	DIÁMETRO	ESPESOR
TOYOTA	TC-591-15	∅ 82.50mm	≅ ---mm
DESCRIPCIÓN / Descrição / Description			
COROLLA 16V/1992/2000 CARINA - AVENSIS (1111516130/150)			
MOTOR / Engine		CM3	HP
4AFE (DOHC)		1587	90
		∅ PISTÓN	
			81.00

MARCA / Brand	CÓDIGO	DIÁMETRO	ESPESOR
TOYOTA	TC-850-07	∅ 79.00mm	≅ 1.50mm
DESCRIPCIÓN / Descrição / Description			
CHARMANT 1981/83 - TOYOTA: COROLLA - CARINA - TERCEL - CORSA 1978/83 SPRINTER (1111515020/30/41)			
MOTOR / Engine		CM3	HP
1A - 3A - 1AU - 3AU		1452	80
		∅ PISTÓN	
			77.50

MARCA / Brand	CÓDIGO	DIÁMETRO	ESPESOR
TOYOTA	TC-852-15	∅ 83.20mm	≅ 1.50mm
DESCRIPCIÓN / Descrição / Description			
COROLLA AE95/92/1987/1992 CELICA - CARINA (1111516080/81/82/90/100)			
MOTOR / Engine		CM3	HP
4AFE / 4AF		1587	90/95 105
		∅ PISTÓN	
			81.00

MARCA / Brand	CÓDIGO	DIÁMETRO	ESPESOR
TOYOTA	TC-272-20 1M	∅ 76.00mm	1.45mm
	TC-272-20 2M	∅ 76.00mm	1.55mm
	TC-272-20 3M	∅ 76.00mm	1.65mm
	TC-272-MG 1M	∅ 76.00mm	1.45mm
	TC-272-MG 2M	∅ 76.00mm	1.55mm
	TC-272-MG 3M	∅ 76.00mm	1.65mm
DESCRIPCIÓN / Descrição / Description			
COROLLA - STARLET 1987/96			
MOTOR / Engine		CM3	HP
1N		1453	54
		∅ PISTÓN	
			74.00

MARCA / Brand	CÓDIGO	DIÁMETRO	ESPESOR
TOYOTA	TC-846-07	∅ -----	≅ 1.50mm
DESCRIPCIÓN / Descrição / Description			
DELTA 1972/75 - TAFT 1976/81 - TOYOTA: CORONA - HILUX - HIACE RN20 TOYOACE 1971/75 - TOWNACE 1976/...(1111531020)			
MOTOR / Engine		CM3	HP
12R/R-J/R-U		1588	80/83
		∅ PISTÓN	
			80.50

MARCA / Brand	CÓDIGO	DIÁMETRO	ESPESOR
TOYOTA	TC-851-07	∅ 82.00mm	≅ 1.70mm
DESCRIPCIÓN / Descrição / Description			
DELTA WIDE 1990/... - TOYOTA: COROLLA - LITEACE KE74A 1984/... (1111513040)			
MOTOR / Engine		CM3	HP
5K-J/5K-U		1486	68
		∅ PISTÓN	
			80.50

MARCA / Brand	CÓDIGO	DIÁMETRO	ESPESOR
TOYOTA	TC-478-07	∅ 87.80mm	≅ 1.40mm
DESCRIPCIÓN / Descrição / Description			
CHARMANT - DELTA WIDE 1970/82 - TOYOTA: CARINA - CELICA - CAMRY - TOWNACE COROLLA - SPRINTER - CORONA 1970/82 (1111526031)			
MOTOR / Engine		CM3	HP
2T - 2TJ - 3T - 12TU - 13T		1588	100
		1778	105
		∅ PISTÓN	
			85.00
			85.00

MARCA / Brand	CÓDIGO	DIÁMETRO	ESPESOR
TOYOTA	TC-854-07	∅ 80.00mm	≅ 1.80mm
DESCRIPCIÓN / Descrição / Description			
COROLLA - CARINA - LEVIN - TRUENO SOLUNA 1992/... 16V (1111515072)			
MOTOR / Engine		CM3	HP
5AF/FE		1498	95
		∅ PISTÓN	
			78.70

MARCA / Brand	CÓDIGO	DIÁMETRO	ESPESOR
TOYOTA	TC-593-15	∅ 82.50mm	≅ ---mm
DESCRIPCIÓN / Descrição / Description			
COROLLA 1992/2001 16V CARINA - CELICA 1993/99 (1111516120/121)			
MOTOR / Engine		CM3	HP
7A-FE		1762	106/110
		∅ PISTÓN	
			81.00

JUNTAS CULATA DE CILINDROS (TC)

Modelos No incluídos en los Juegos Completos de Reparación

ILLINOIS

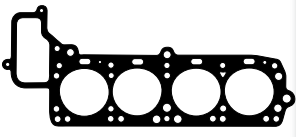

JUNTA DE CABEÇOTE Modelos não incluídos nos Jogo de Juntas do Motor
CYLINDER HEAD GASKET Models not included in Full Set Gasket

MARCA / Brand	CÓDIGO	DIÁMETRO	ESPEJOR
TOYOTA	TC-490-06	Ø 90.00mm	≅ 1.60mm
DESCRIPCIÓN / Descrição / Description			
HILUX - CORONA - MARK II - CELICA MARK - CRESSIDA - HIACE CARINA 1966/..			
			
MOTOR / Engine	CM3	HP	Ø PISTÓN
6R - 7R - 8R - 16R - 18R	1591 - 1707 1808 - 1858 1968	85 110	86.00 88.50

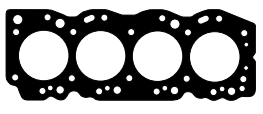
MARCA / Brand	CÓDIGO	DIÁMETRO	ESPEJOR
TOYOTA	TC-574-20	Ø 94.00mm	≅ 1.60mm
DESCRIPCIÓN / Descrição / Description			
HILUX - CROWN - TOYO ACE - HIACE CRESSIDA - CHASSER - BLIZZARD MARK II 1977/... (1111554010/11/12/20/21)			
			
MOTOR / Engine	DIESEL	CM3	HP
L - 2L - 2LT - 2LTE		2188 2446	67 86
			Ø PISTÓN
			90.00 92.00

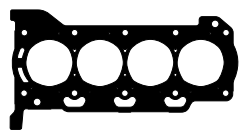
MARCA / Brand	CÓDIGO	DIÁMETRO	ESPEJOR
TOYOTA	TC-343-11	Ø 81.50mm	≅ 1.10mm
DESCRIPCIÓN / Descrição / Description			
AURIS 2006/... - COROLLA VERSO 2006/... (1111537030)			
			
MOTOR / Engine	CM3	HP	Ø PISTÓN
1ZR-FE 2ZR-FAE	1598 1798	124 147	80.50 80.50

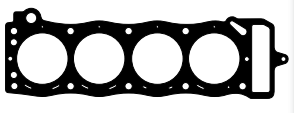
MARCA / Brand	CÓDIGO	DIÁMETRO	ESPEJOR
TOYOTA	TC-848-07	Ø 94.00mm	≅ 1.60mm
DESCRIPCIÓN / Descrição / Description			
DYNA - HILUX - COASTER - CORONA CELICA - 4 RUNNER 1980/84 TURBO 1985/96 - LANDCRUISER (1111535010)			
			
MOTOR / Engine	CM3	HP	Ø PISTÓN
22R - 22REC - 22RTEC		2367	100/114
			92.00

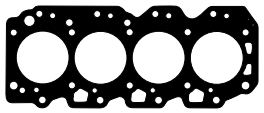
MARCA / Brand	CÓDIGO	DIÁMETRO	ESPEJOR
TOYOTA/DAIHATSU	TC-554-20 TC-554-MG	Ø 84.00mm Ø 84.00mm	≅ 1.60mm ≅ 1.60mm
DESCRIPCIÓN / Descrição / Description			
COROLLA - TOWNACE - CARINA DAIHATSU: DELTA WIDE 1982/88 (1111564010/20)			
			
MOTOR / Engine	DIESEL	CM3	HP
1C		1839	64
			Ø PISTÓN
			83.00

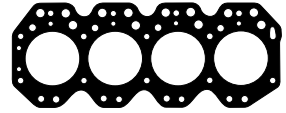
MARCA / Brand	CÓDIGO	DIÁMETRO	ESPEJOR
TOYOTA	TC-553-06	Ø 102.20mm	≅ 1.45mm
DESCRIPCIÓN / Descrição / Description			
COASTER - DYNA - LANDCRUISER DELTA 1972/80 (1111556010/11)			
			
MOTOR / Engine	DIESEL	CM3	HP
B - 2B		2977 3168	85 98
			Ø PISTÓN
			95.00 98.00

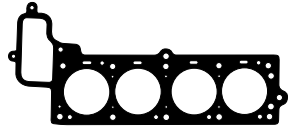
MARCA / Brand	CÓDIGO	DIÁMETRO	ESPEJOR
TOYOTA	TC-518-06	Ø 91.80mm	≅ 1.50mm
DESCRIPCIÓN / Descrição / Description			
CARINA GT DOHC 1977/... CELICA GT (1111588231/70)			
			
MOTOR / Engine	CM3	HP	Ø PISTÓN
18R-GU/GEU		1968	130
			89.00

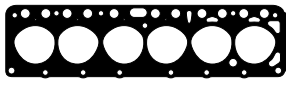
MARCA / Brand	CÓDIGO	DIÁMETRO	ESPEJOR
TOYOTA	TC-856-07	Ø 97.00mm	≅ 1.60mm
DESCRIPCIÓN / Descrição / Description			
LANDCRUISER F J62 1989/92 (1111561020)			
			
MOTOR / Engine	CM3	HP	Ø PISTÓN
3F/E		3956	140
			94.00

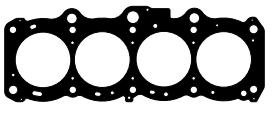
MARCA / Brand	CÓDIGO	DIÁMETRO	ESPEJOR
TOYOTA	TC-903-11	Ø 87.00mm	≅ 1.50mm
DESCRIPCIÓN / Descrição / Description			
RAV4 1996/01 - CARINA E 1996/97 CORONA - PICNIC - AVENSIS (1111574110)			
			
MOTOR / Engine	CM3	HP	Ø PISTÓN
3S-FE		1998	117
			86.00

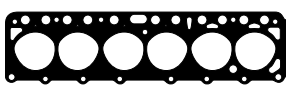
MARCA / Brand	CÓDIGO	DIÁMETRO	ESPEJOR
TOYOTA	TC-855-07	Ø 97.00mm	≅ 1.60mm
DESCRIPCIÓN / Descrição / Description			
LANDCRUISER 6 CIL FJ60 1975/84 (1111561010)			
			
MOTOR / Engine	CM3	HP	Ø PISTÓN
2F OHV		4230	140
			94.00

JUNTAS CULATA DE CILINDROS (TC)

Modelos No incluídos en los Juegos Completos de Reparación



JUNTA DE CABEÇOTE Modelos não incluídos nos Jogo de Juntas do Motor

CYLINDER HEAD GASKET Models not included in Full Set Gasket

MARCA / Brand	CÓDIGO	DIÁMETRO	ESPEJOR	
VOLKSWAGEN	TC-142-20 1M	∅ 78.40mm	≠ 1.50mm	
	TC-142-20 2M	∅ 78.40mm	≠ 1.60mm	
	TC-142-20 3M	∅ 78.40mm	≠ 1.70mm	
	TC-142-20 4M	∅ 78.40mm	≠ 1.80mm	
DESCRIPCIÓN / Descrição / Description				
BOTADOR HIDRAULICO				
SENDA - SAVEIRO - GOL				
MOTOR / Engine		CM3	HP	∅ PISTÓN
		1588	54/70	76.50

MARCA / Brand	CÓDIGO	DIÁMETRO	ESPEJOR	
VOLVO	TC-690-15	∅ 84.50mm	≠ 1.50mm	
DESCRIPCIÓN / Descrição / Description				
S70 LS - V70 LV - 850 (3531017/35310176)				
MOTOR / Engine		CM3	HP	∅ PISTÓN
B5252/S/FS		2435	140	83.00
B5254F/S/T		2435	144	83.00
GB5252S		2435	144	83.00

ILLINOIS[®]

JUNTAS PARA
CAJA DE VELOCIDAD

ESP

JUNTAS PARA
CAIXA DE CÂMBIO

PORT

GEAR BOX
GASKETS

ENG

JV

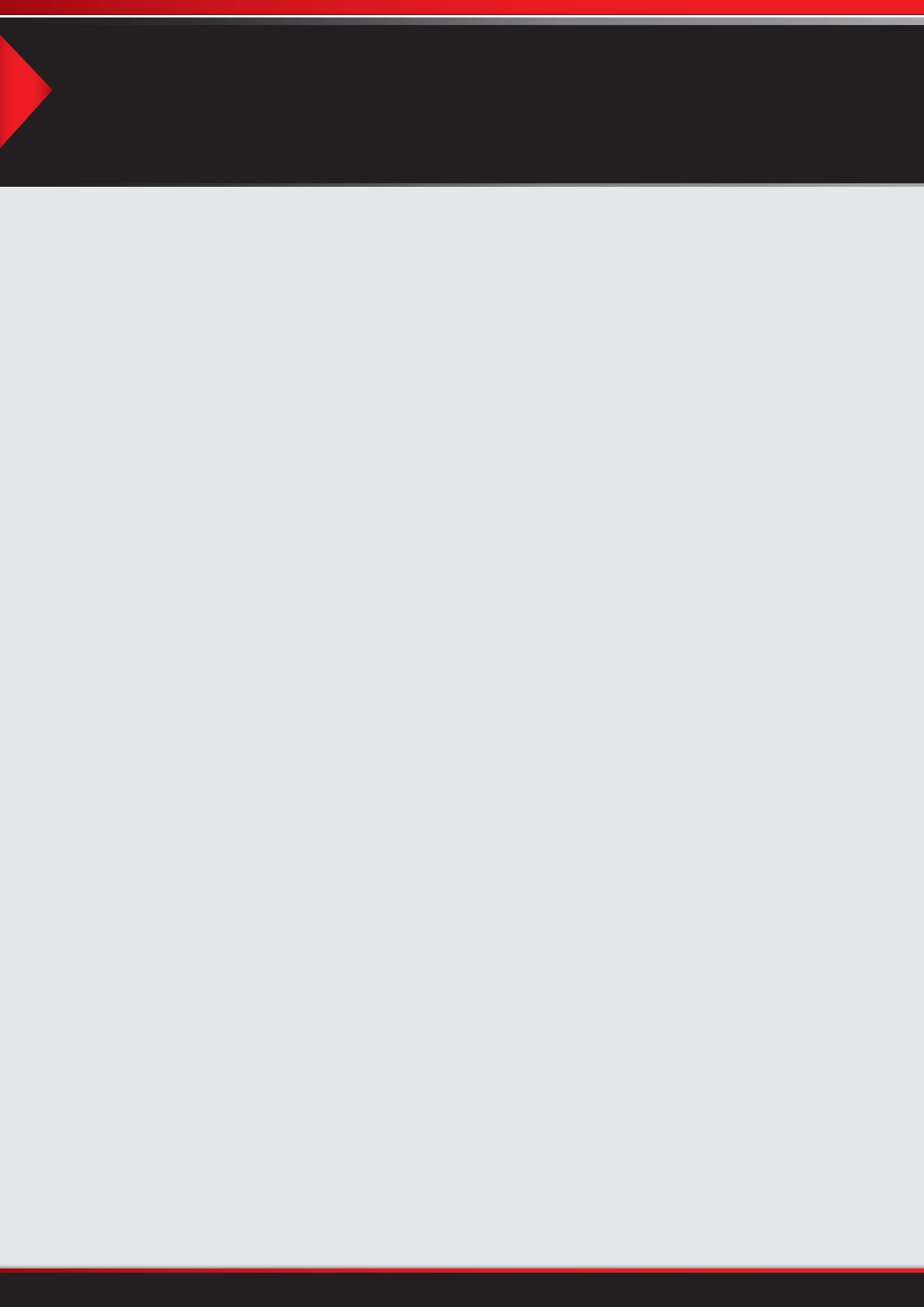

JUEGO JUNTAS PARA CAJA DE VELOCIDAD (JV)

Jogo de Juntas para Caixa de Câmbio
Gear Box Set Gaskets

Orden alfabético / Ordem alfabética
Alphabetical order

REF.	MARCA / BRAND	MODELO / MODEL	PAG.
JV-102	CHEVROLET	400 FAE 1ra. Sincronizada	419
JV-103	CHEVROLET	SUPER SPECIAL RALLY SPORT 400/63 SS 6 Cil 2da. Serie - FAE 1ra. Sincronizada	419
JV-187	CHEVROLET OPEL	CORSA COMBO KADETT ASTRA 1,4/1,6	419
JV-190	CHEVROLET	VECTRA F 18	419
JV-192	CHEVROLET	PICK UP LUV ISUZU 2.5 5 Velocidades	419
JV-153	CHEVROLET FORD	C20 - F100 / 150 Caja Clark 2205 - 2215 - 5 Velocidades	419
JV-108	DODGE	1500 - 1800 - VW1500 - 1800 - TODOS 4 Velocidades	419
JV-110	FIAT	600 - 600 E.D.F.R. - 750 - 880 4 Velocidades	419
JV-111	FIAT	1500 - 1600 63/72	419
JV-112	FIAT	127/128 - 1100/1300 - RITMO 60 Hasta 1977 4 Velocidades	420
JV-113	FIAT	1300/1500 - 1600 - 125 73/80 - LADA 1.6 - NIVA 2121 1ra. Serie - 4 Velocidades	420
JV-131	FIAT	133 - 600S 4 Velocidades	420
JV-134	FIAT	147 - UNO - DUNA 1.4/1.5/1.6 - 128 1100/1500 - SUPER EUROPA Caja de 4ta y 5ta	420
JV-160	FIAT	UNO - DUNA 1.7 D(92) - PALIO - SIENA - TEMPRA - IVECO Caja Nacional - 5 Velocidades	420
JV-163	FIAT	DUCATO 1.7/1.9 NAFTA - 2.5/2.8 D/DT 4 Velocidades	420
JV-115	FORD	TAUNUS 2.0/2.3 - SIERRA 2.3 4 Velocidades	420
JV-142	FORD	TAUNUS/GHIA - SIERRA 5 Velocidades	420
JV-151	FORD	FIESTA 2003/... 4 y 5 Velocidades	420
JV-158	FORD	1.3/1.5 ESCORT GL - GS - KA - FIESTA - ORION 1995/... 5 Velocidades	420
JV-130	FORD	F100 - FAIRLANE 1966/77 Caja 303 - 1ª Sincronizada - 3 Velocidades	421
JV-166	FORD	F100 (81/88) - BORGWARD - WARNER 3.19	421
JV-172	FORD	RANGER - F100	421
JV-149	FORD	F100 - F1000 - MOTOR MWM DIESEL 1992 Caja Clarck - 5 Velocidades	421

REF.	MARCA / BRAND	MODELO / MODEL	PAG.
JV-150	FORD	F100 - F1000 5ta. Hummer Naftera 1990	421
JV-132	FORD	F350 - F600 - WARNER 4 Velocidades	421
JV-109	JEEP FORD	IKA - JEEP - BERGANTIN - ESTANCIERA - FALCON - GLADIADOR Tracción Simple 4cil. 4L151 - 6cil. 6L226	421
JV-156	PEUGEOT	405 - 306 - 205 DIESEL Y NAFTERO 1991... Caja BE3/5 - 5 Velocidades	421
JV-120	PEUGEOT	404 504 1962/80 - 1.6 - XC7 Caja C3B - 4 Velocidades	421
JV-157	PEUGEOT	404 - 504 - 505 1971... Caja BA7 - 4/5 Velocidades	421
JV-121	PEUGEOT RASTROJERO	MOTOR INDENOR - RASTROJERO DIESEL - 4 CIL. Indenor - XDP 4.88	422
JV-122	RASTROJERO	PICK UP NP6 1955/69 - 1.8 BORGWARD D4M	422
JV-126	RENAULT	DAUPHINE - 4L - 4F 3/4 Velocidades	422
JV-127	RENAULT	R6 - R4 GTL	422
JV-128	RENAULT	R12 - BREAK 4 velocidades	422
JV-138	RENAULT	R12 5 Velocidades	422
JV-139	RENAULT	R18 - FUEGO 2.0 5 Velocidades	422
JV-154	RENAULT	R9 - R11 - R12 - R18 - R19 - CLIO EXPRESS KANGOO NAFTA/DIESEL	422
JV-146	RENAULT	TRAFIC - PICK UP DIESEL 4/5 Velocidades	422
JV-129	SAGINAW	CHEVROLET - COUPE S/SS 1972/75 - FORD Saginaw 4 Velocidades	419
JV-144	TORINO	7B Caja ZF - 4 Velocidades	422
JV-185	TOYOTA	HILUX (MODELO NUEVO)	423
JV-164	TOYOTA	PICK UP 2.2	423
JV-140	VOLKSWAGEN	GACEL 4 Velocidades - 2ª Serie 1983/85	423
JV-141	VOLKSWAGEN	GACEL - CARAT - SAVEIRO - SENDA - GOL 5 Velocidades - 1,8 lts - Nafta/Diesel	423
JV-177	VOLKSWAGEN	POINTER - ORION - ESCORT - GOLF - POLO DIESEL Caja 827 MQ	423
JV-159	VOLKSWAGEN	GOL GOLF SANTANA GACEL AP AUDI Caja 827	423

JUEGO JUNTAS PARA CAJA DE VELOCIDAD (JV)

Jogo de Juntas para Caixa de Câmbio / Gear Box Set Gaskets

ILLINOIS



CÓDIGO / Code	MARCA / Brand	DESCRIPCIÓN / Descrição / Description
JV-102	CHEVROLET	400 <i>FAE 1ra. Sincronizada</i>

CÓDIGO / Code	MARCA / Brand	DESCRIPCIÓN / Descrição / Description
JV-153	CHEVROLET FORD	C20 - F100/150 <i>Caja Clark 2205 - 2215 5 Velocidades</i>

CÓDIGO / Code	MARCA / Brand	DESCRIPCIÓN / Descrição / Description
JV-103	CHEVROLET	SUPER SPECIAL RALLY SPORT 400/63 SS 6 Cil <i>2da. Serie - FAE 1ra. Sincronizada</i>

CÓDIGO / Code	MARCA / Brand	DESCRIPCIÓN / Descrição / Description
JV-129	CHEVROLET	CHEVROLET - COUPE S/SS 1972/75 - FORD <i>Saginaw 4 Velocidades</i>

CÓDIGO / Code	MARCA / Brand	DESCRIPCIÓN / Descrição / Description
JV-187	CHEVROLET OPEL	CORSA COMBO KADETT ASTRA 1.4 - 1.6

CÓDIGO / Code	MARCA / Brand	DESCRIPCIÓN / Descrição / Description
JV-108	DODGE	1500 - 1800 - VW1500 - 1800 TODOS <i>4 Velocidades</i>

CÓDIGO / Code	MARCA / Brand	DESCRIPCIÓN / Descrição / Description
JV-190	CHEVROLET	VECTRA F 18

CÓDIGO / Code	MARCA / Brand	DESCRIPCIÓN / Descrição / Description
JV-110	FIAT	600 - 600 E.D.F.R. - 750 880 <i>4 Velocidades</i>

CÓDIGO / Code	MARCA / Brand	DESCRIPCIÓN / Descrição / Description
JV-192	CHEVROLET	PICK UP LUV ISUZU 2.5 <i>5 Velocidades</i>

CÓDIGO / Code	MARCA / Brand	DESCRIPCIÓN / Descrição / Description
JV-111	FIAT	1500 - 1600 63/72

JUEGO JUNTAS PARA CAJA DE VELOCIDAD (JV)

ILLINOIS

Jogo de Juntas para Caixa de Câmbio / Gear Box Set Gaskets

CÓDIGO / Code	MARCA / Brand	DESCRIPCIÓN / Descrição / Description
JV-112	FIAT	127/128 - 1100/1300 - RITMO 60 Hasta 1977 4 Velocidades

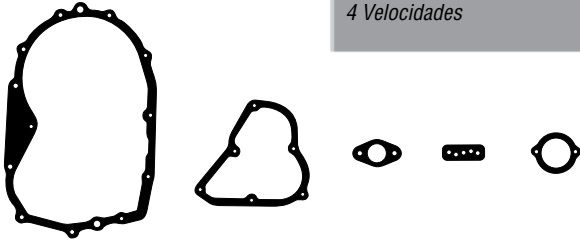

CÓDIGO / Code	MARCA / Brand	DESCRIPCIÓN / Descrição / Description
JV-163	FIAT	DUCATO 1.7/1.9 NAFTA 2.5/2.8 D/DT 4 Velocidades



CÓDIGO / Code	MARCA / Brand	DESCRIPCIÓN / Descrição / Description
JV-113	FIAT	1300/1500 - 1600 - 125 73/80 LADA 1.6 - NIVA 2121 1ra. Serie - 4 Velocidades

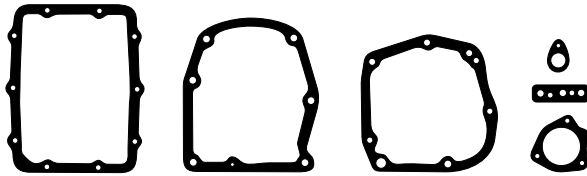

CÓDIGO / Code	MARCA / Brand	DESCRIPCIÓN / Descrição / Description
JV-115	FORD	TAUNUS 2.0/2.3 SIERRA 2.3 4 Velocidades

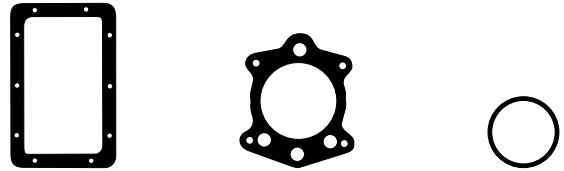

CÓDIGO / Code	MARCA / Brand	DESCRIPCIÓN / Descrição / Description
JV-131	FIAT	133 - 600S 4 Velocidades

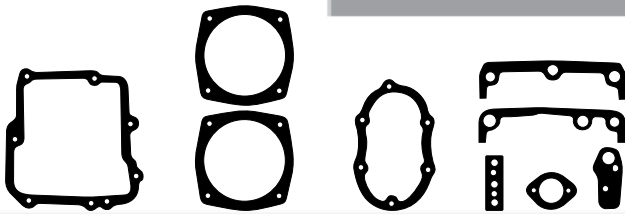

CÓDIGO / Code	MARCA / Brand	DESCRIPCIÓN / Descrição / Description
JV-142	FORD	TAUNUS/GHIA - SIERRA 5 Velocidades

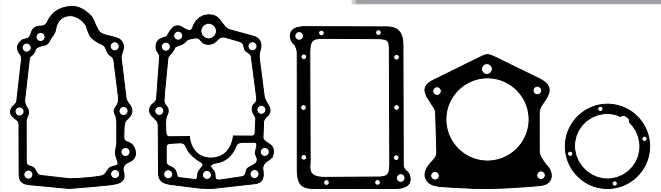

CÓDIGO / Code	MARCA / Brand	DESCRIPCIÓN / Descrição / Description
JV-134	FIAT	147 - UNO - DUNA 1.4/1.5/1.6 128 1100/1500 - SUP. EUROPA Caja de 4ta y 5ta

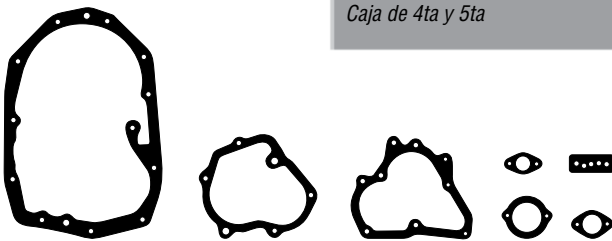

CÓDIGO / Code	MARCA / Brand	DESCRIPCIÓN / Descrição / Description
JV-151	FORD	FIESTA 2003/... 4 y 5 Velocidades

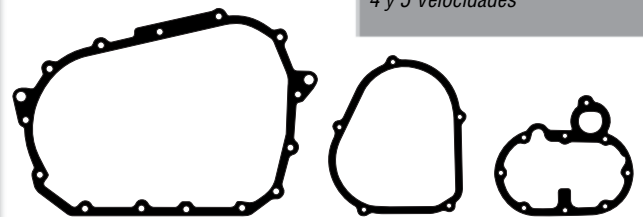

CÓDIGO / Code	MARCA / Brand	DESCRIPCIÓN / Descrição / Description
JV-160	FIAT	DUNA 1.7 D (92) - TEMPRA PALIO - SIENA - IVECO - UNO Caja Nacional - 5 Velocidades



CÓDIGO / Code	MARCA / Brand	DESCRIPCIÓN / Descrição / Description
JV-158	FORD	1.3/1.5 ESCORT GL - GS - KA FIESTA - ORION 1995/... 5 Velocidades

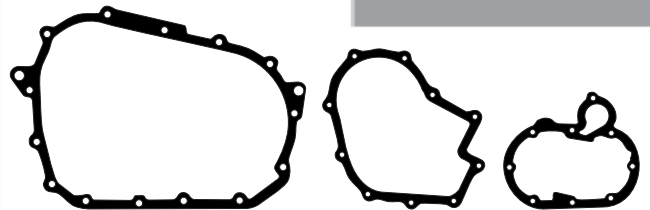

JUEGO JUNTAS PARA CAJA DE VELOCIDAD (JV)

Jogo de Juntas para Caixa de Câmbio / Gear Box Set Gaskets

ILLINOIS



CÓDIGO / Code	MARCA / Brand	DESCRIPCIÓN / Descrição / Description
JV-130	FORD	F100 - FAIRLANE 1966/77 <i>Caja 303 - 1ª Sincronizada 3 Velocidades</i>

CÓDIGO / Code	MARCA / Brand	DESCRIPCIÓN / Descrição / Description
JV-109	JEEP FORD	IKA - ESTANCIERA - BERGANTIN JEEP - FALCON - GLADIADOR <i>Tracción Simple 4 cil. 4L151 6 cil. 6L226</i>

CÓDIGO / Code	MARCA / Brand	DESCRIPCIÓN / Descrição / Description
JV-166	FORD	F100 (81/88) - BORGWARD WARNER 3.19

CÓDIGO / Code	MARCA / Brand	DESCRIPCIÓN / Descrição / Description
JV-149	FORD	F100 - F1000 MOTOR MWM DIESEL 1992 <i>Caja Clarck - 5 Velocidades</i>

CÓDIGO / Code	MARCA / Brand	DESCRIPCIÓN / Descrição / Description
JV-172	FORD	F100 - RANGER

CÓDIGO / Code	MARCA / Brand	DESCRIPCIÓN / Descrição / Description
JV-156	PEUGEOT	405 - 306 - 205 DIESEL NAFTERO 1991... <i>Caja BE3/5 - 5 Velocidades</i>

CÓDIGO / Code	MARCA / Brand	DESCRIPCIÓN / Descrição / Description
JV-150	FORD	F100 - F1000 <i>5ta. Hummer Naftera 1990</i>

CÓDIGO / Code	MARCA / Brand	DESCRIPCIÓN / Descrição / Description
JV-120	PEUGEOT	404 504 1962/80 - 1.6 - XC7 <i>Caja C3B - 4 Velocidades</i>

CÓDIGO / Code	MARCA / Brand	DESCRIPCIÓN / Descrição / Description
JV-132	FORD	F350 - F600 - WARNER <i>4 Velocidades</i>

CÓDIGO / Code	MARCA / Brand	DESCRIPCIÓN / Descrição / Description
JV-157	PEUGEOT	404 - 504 - 505 1971/... <i>Caja BA7 - 4 y 5 Velocidades</i>

JUEGO JUNTAS PARA CAJA DE VELOCIDAD (JV)



Jogo de Juntas para Caixa de Câmbio / Gear Box Set Gaskets

CÓDIGO / Code	MARCA / Brand	DESCRIPCIÓN / Descrição / Description
JV-121	PEUGEOT	MOTOR INDENOR RASTROJERO DIESEL - 4 CIL. <i>Indenor - XDP 4.88</i>

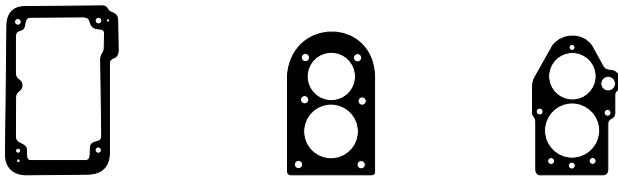

CÓDIGO / Code	MARCA / Brand	DESCRIPCIÓN / Descrição / Description
JV-138	RENAULT	R12 <i>5 Velocidades</i>

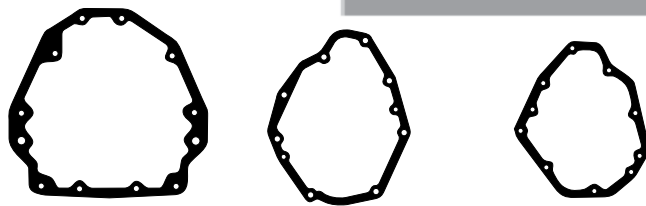

CÓDIGO / Code	MARCA / Brand	DESCRIPCIÓN / Descrição / Description
JV-122	RASTROJERO	PICK UP NP6 1955/69 - 1.8 BORGWARD D4M

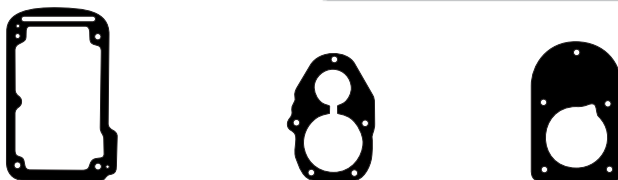

CÓDIGO / Code	MARCA / Brand	DESCRIPCIÓN / Descrição / Description
JV-139	RENAULT	R18 - FUEGO 2.0 <i>5 Velocidades</i>

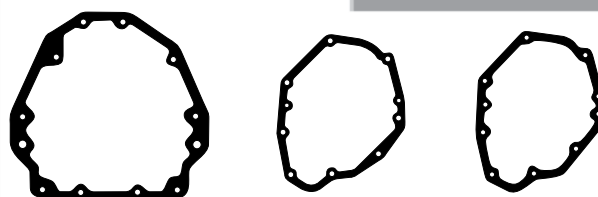

CÓDIGO / Code	MARCA / Brand	DESCRIPCIÓN / Descrição / Description
JV-126	RENAULT	DAUPHINE - 4L - 4F <i>3/4 Velocidades</i>

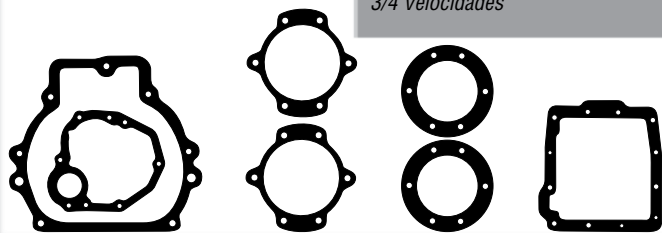

CÓDIGO / Code	MARCA / Brand	DESCRIPCIÓN / Descrição / Description
JV-154	RENAULT	R9 - R11 - R12 - R18 - R19 - CLIO EXPRESS - KANGOO NAFTA/DIESEL

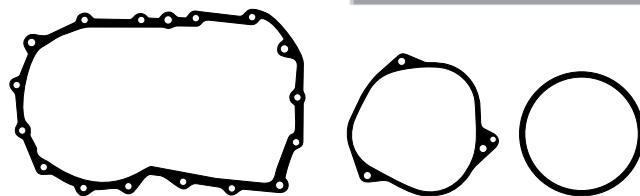

CÓDIGO / Code	MARCA / Brand	DESCRIPCIÓN / Descrição / Description
JV-127	RENAULT	R6 - R4 GTL

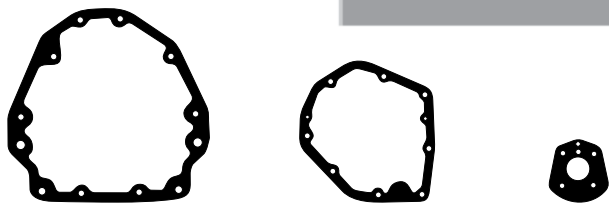

CÓDIGO / Code	MARCA / Brand	DESCRIPCIÓN / Descrição / Description
JV-146	RENAULT	TRAFIC - PICK UP DIESEL <i>4/5 Velocidades</i>

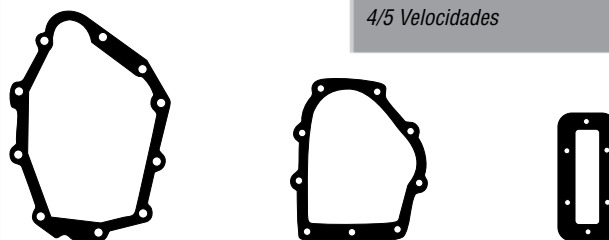

CÓDIGO / Code	MARCA / Brand	DESCRIPCIÓN / Descrição / Description
JV-128	RENAULT	R12 - BREAK <i>4 velocidades</i>

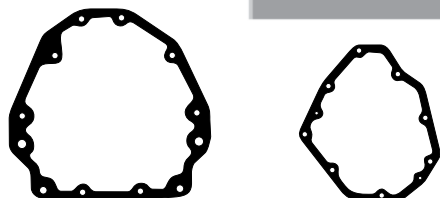

CÓDIGO / Code	MARCA / Brand	DESCRIPCIÓN / Descrição / Description
JV-144	TORINO	7B <i>Caja ZF - 4 Velocidades</i>

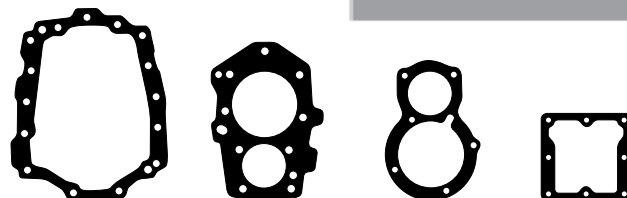

JUEGO JUNTAS PARA CAJA DE VELOCIDAD (JV)

Jogo de Juntas para Caixa de Câmbio / Gear Box Set Gaskets

ILLINOIS®



CÓDIGO / Code	MARCA / Brand	DESCRIPCIÓN / Descrição / Description
JV-185	TOYOTA	HILUX (MODELO NUEVO)

CÓDIGO / Code	MARCA / Brand	DESCRIPCIÓN / Descrição / Description
JV-159	VOLKSWAGEN	GOL GOLF SANTANA GACEL AP AUDI <i>Caja 827</i>

CÓDIGO / Code	MARCA / Brand	DESCRIPCIÓN / Descrição / Description
JV-164	TOYOTA	PICK UP 2.2

CÓDIGO / Code	MARCA / Brand	DESCRIPCIÓN / Descrição / Description
JV-140	VOLKSWAGEN	GACEL <i>4 Velocidades - 2ª Serie 1983/85</i>

CÓDIGO / Code	MARCA / Brand	DESCRIPCIÓN / Descrição / Description
JV-141	VOLKSWAGEN	GACEL - CARAT - SAVEIRO SENDA - GOL <i>5 Velocidades - 1,8 lts Nafta/Diesel</i>

CÓDIGO / Code	MARCA / Brand	DESCRIPCIÓN / Descrição / Description
JV-177	VOLKSWAGEN	POINTER - ORION - ESCORT GOLF - POLO DIESEL <i>Caja 827 MQ</i>

JUNTAS PARA
TURBO COMPRESOR

ESP

JUNTAS PARA
TURBO COMPRESSOR
(TURBINA)

PORT

TURBO COMPRESSOR
GASKETS

ENG

JT

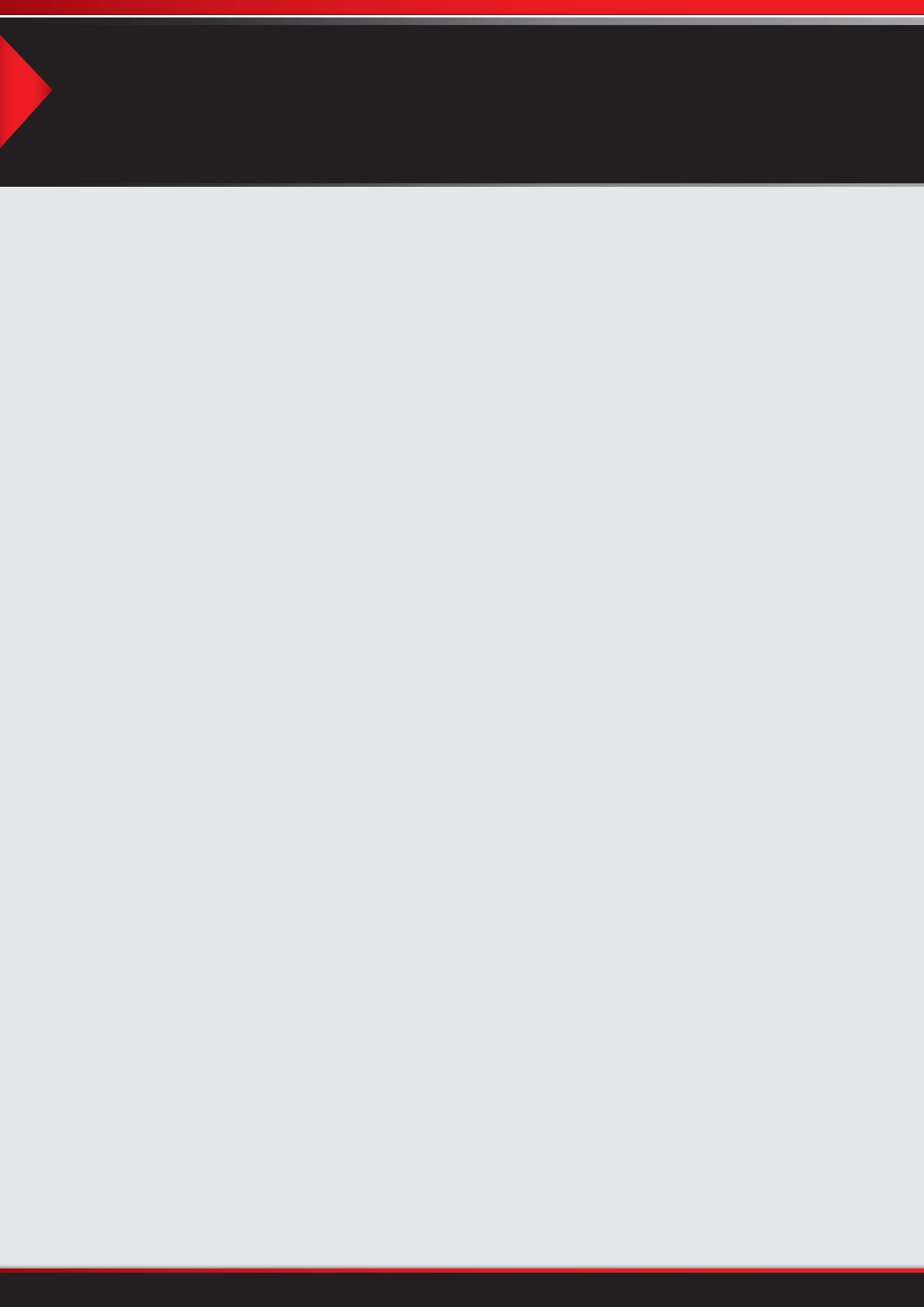

JUEGO JUNTAS PARA TURBO COMPRESOR (JT) Jogo de Juntas para Turbo Compressor Turbo Compressor Set Gaskets

Orden alfabético / Ordem alfabética
Alphabetical order



REF.	MARCA / BRAND	MODELO / MODEL	PAG.
JT-128	CHEVROLET	CORSA ASTRA COMBO TOUR - Y17DIT/DTL 16V (JUEGO)	429
JT-110	CHEV/FORD/M.BENZ	RANGER HSD - S10 - BLAZER 310 - 360 SPRI (JUEGO)	429
JT-117	FIAT	DUCATO IVECO DAILY 2,8 DIESEL (JUEGO)	429
JT-109	FIAT/FORD	PALIO SIENA MONDEO TRANSIT (JUEGO)	429
JT-144	FIAT	DUCATO JTD 16V MULTIJET DAILY 2.3 MITSUBISHI TFO35 49135-05131 (215290)	429
JT-124	FORD/CITROEN/PEUGEOT	ECOSPORT FIESTA - 206 - 307 - C3 - 1,4 DIESEL - DV4TD (JUEGO)	429
JT-122	FORD/MAXION	POWER STROKE 2,8 RANGER TD (JUEGO)	429
JT-132	FORD	F100/150/250 DUTY ELECTR. (ISBE) CARGO 815E/915E/1317/1517/1717 - HOLSET HE221 (JUEGO)	429
JT-147	M.BENZ/FIAT/CHEV/FORD	SPRINTER DUCATO S10 BLAZER 310/360 RANGER (JUEGO)	430
JT-142	M.BENZ	SPRINTER 413/11 208/11/13 DCI 2000/... C200 C220 E200 E220 1998/... - 2,2 - OM611 CDI (JUEGO)	430
JT-140	M.BENZ/M.W.M.	M. BENZ OM904 AGRALE MT15 MA15 (JUEGO)	430
JT-115	M.W.M.	SPRINT 4 - 6 CIL. (JUEGO)	430
JT-116	MAXION	S4T (JUEGO)	430
JT-138	MTU	GENERADOR ELECTRICO MTU (JUEGO)	430
JT-105	PEUGEOT	TURBO 505 (JUEGO)	430
JT-118	PEUGEOT	206 - 307 - PARTNER 2,0 DIESEL - MOTOR DW10 (JUEGO)	430
JT-141	PEUGEOT/FORD/CITROEN	307 HDI 407 TD 2004/... FOCUS C-MAX TDCI 2003/... XSARA PICASSO C4 C5 TD 1,6 DV6TED4/TD4 G8DA 16V (JUEGO)	431
JT-119	RENAULT	CLIO II KANGOO MEGANE DCI 1,5 - K9K COMMONRAIL DIESEL (JUEGO)	431
JT-123	RENAULT	MEGANE SCENIC CLIO 1,9 DIESEL - F9Q (JUEGO)	431
JT-155	RENAULT/NISSAN	MASTER TRAFIC PRIMASTAR INTERSTAR - 2.5 - G9U	431
JT-129	TOYOTA	HILUX 3,0 - 3L/3LT CT20/CT26 (JUEGO)	431
JT-120	VOLKSWAGEN	PASSAT 1,9 TDI MOTOR 115PD/PD UI DIESEL (JUEGO)	431
JT-121	VOLKSWAGEN	PASSAT 1,9 TDI DIESEL (JUEGO)	431
JT-143	VOLKSWAGEN	BORA GOLF AUDI A3 SEAT - 1,8 - NAFTA (JUEGO)	431
JT-151	VOLKSWAGEN	TURBO PASSAT BORA SHARAN A4 A6 - 1.8	432





JUEGO JUNTAS PARA TURBO COMPRESOR (JT)





ILLINOIS



Jogo de Juntas para Turbo Compressor / Turbo Compressor Set Gaskets



CÓDIGO / Code	MARCA / Brand	DESCRIPCIÓN / Descrição / Description
JT-128	CHEVROLET	CORSA - ASTRA COMBO TOUR Y17DIT/DTL 16V
		
JT-128-01 Junta turbo		JT-128-02 Junta turbo
		
JT-118-03 Brida turbo		2617700 Arandela 12 x 16 x 1,5mm Arruela (Cobre)







CÓDIGO / Code	MARCA / Brand	DESCRIPCIÓN / Descrição / Description
JT-144	FIAT	DUCATO JTD 16V MULTIJET DAILY 2.3
		
JT-117-01 Colector a turbo Coletor ao turbo		JT-144-01 Junta Turbo
		
		1087300 Entrada aceite Entrada óleo





CÓDIGO / Code	MARCA / Brand	DESCRIPCIÓN / Descrição / Description
JT-110	CHEVROLET FORD/M.BENZ	RANGER HSD S10 BLAZER 310-360 SPRI
		
JT-110-02 Base turbo espárragos/prisioneiro ø 10mm		JT-110-03 Paso aceite Paso óleo
		
2611400 Arandela Arruela (Aluminio) 12 x 19 x 1,5mm		JT-110-01 Turbo
		
		2617800 Arandela Arruela (Aluminio) 16 x 22 x 1,5mm

CÓDIGO / Code	MARCA / Brand	DESCRIPCIÓN / Descrição / Description
JT-124	FORD/CITROEN PEUGEOT	ECOSPORT FIESTA - 206 307 C3 - 1,4 DIESEL - DV4TD
		
JT-124-01 Salida turbo Saída turbo		2702700 O'ring 28 x 3,5mm
		
2627300 Arandela Arruela (Cobre) 19 x 25,5 x 1,25mm		JT-124-02 Colector turbo Coletor turbo
		
		2619200 Arandela Arruela (Cobre) 10 x 14 x 1mm

CÓDIGO / Code	MARCA / Brand	DESCRIPCIÓN / Descrição / Description
JT-117	FIAT	DUCATO IVECO DAILY 2,8 DIESEL
		
JT-117-01 Colector a turbo Coletor ao turbo		JT-117-02 Salida turbo Saída turbo
		
		JT-118-03 Brida turbo Flange turbo

CÓDIGO / Code	MARCA / Brand	DESCRIPCIÓN / Descrição / Description
JT-122	FORD/MAXION	POWER STROKE 2,8 RANGER TD
		
JT-122-01 Múltiple de escape a turbo Coletor de escapamento ao turbo		2612900 Arandela Arruela (Aluminio) 10 x 14 x 1,5mm
		
		JT-108-05 - 813913 814914 Paso aceite Paso óleo

CÓDIGO / Code	MARCA / Brand	DESCRIPCIÓN / Descrição / Description
JT-109	FIAT	PALIO - SIENA MONDEO - TRANSIT
		
JT-109-02 Base turbo espárragos/prisioneiro ø 8mm		JT-110-03 Paso aceite Paso óleo
		
2611400 Arandela Arruela (Aluminio) 12 x 19 x 1,5mm		JT-109-01 Turbo
		
		JSA-225 Junta Salida Escape Junta Saída Escapamento
		
		2617800 Arandela Arruela (Aluminio) 16 x 22 x 1,5mm

CÓDIGO / Code	MARCA / Brand	DESCRIPCIÓN / Descrição / Description
JT-132	FORD	HOLSET HE 221 F100/150/250 DUTY ELECTR. - CARGO 815E
		
JT-109-02 Base turbo espárragos/prisioneiro ø 8mm		JT-132-01 Acople escape Acoplamento escapamento
		
2619200 Arandela Arruela (Cobre) 10 x 14 x 1mm		JT-123-04 Brida turbo Flange turbo

JUEGO JUNTAS PARA TURBO COMPRESOR (JT)

ILLINOIS

Jogo de Juntas para Turbo Compressor / Turbo Compressor Set Gaskets

CÓDIGO / Code	MARCA / Brand	DESCRIPCIÓN / Descrição / Description
JT-147	M. BENZ/FIAT CHEVROLET/FORD	SPRINTER DUCATO S10 BLAZER 310/360 RANGER



JT-110-01
Junta turbo



2611400
Arandela
Arruela (Aluminio)
12 x 19 x 1,5mm



JT-110-02
Base turbo



2612900
Arandela
Arruela (Aluminio)
10 x 14 x 1,5mm



JT-110-03
Junta turbo



JT-109-01
Junta turbo



2617800
Arandela
Arruela (Aluminio)
16 x 22 x 1,5mm

CÓDIGO / Code	MARCA / Brand	DESCRIPCIÓN / Descrição / Description
JT-116	MAXION	S4T



JT-116-01
Salida turbo
Saída turbo



JT-114-01
Brida chica
Flange chica

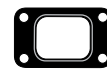

JT-102-02
3520980280
Base turbo



JT-114-02
Brida grande
Flange grande

CÓDIGO / Code	MARCA / Brand	DESCRIPCIÓN / Descrição / Description
JT-142	M. BENZ	SPRINTER 413/11/208/11/13 DCI 2000/... C200 C220 E200 E220 1998/... - 2.2 - OM611 CDI (DOHC)(JUEGO)



JT-142-01
Entrada de gases
Entrada de gases



JT-142-02
Salida de gases
Saída de gases



2617400
Arandela
Arruela (Aluminio)
10 x 15 x 1mm

CÓDIGO / Code	MARCA / Brand	DESCRIPCIÓN / Descrição / Description
JT-138	MTU	GENERADOR ELECTRICO MOTOR MTU



JT-103-03
Descarga de aceite
Retorno de óleo



JT-103-02
Base turbo

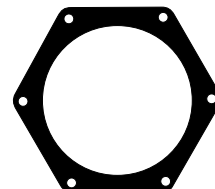

JT-138-01
Junta turbo



JT-103-04
Entrada de aceite
Entrada de óleo

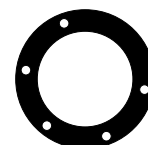

JT-138-02
Junta turbo

CÓDIGO / Code	MARCA / Brand	DESCRIPCIÓN / Descrição / Description
JT-140	M. BENZ/MWM	M. BENZ OM904 MWM AGRALE MT15 MA15



JT-126-01
Colector
Coletor



JT-102-02
Base turbo
Base turbo



2630700
Arandela
Arruela (Cobre)
12,5 x 18,5 x 1mm



2619200
Arandela
Arruela (Cobre)
10 x 14 x 1mm



JT-126-02
Salida turbo
Saída turbo



JT-123-04
Brida turbo
Flange turbo

CÓDIGO / Code	MARCA / Brand	DESCRIPCIÓN / Descrição / Description
JT-105	PEUGEOT	TURBO 505



JT-105-01
Salida turbo
espárragos/prisioneiro ø 9mm



JT-105-04
Descarga aceite
Retorno óleo



JT-102-02
3520980280
Base turbo



JT-105-03
Entrada aceite
Entrada óleo

CÓDIGO / Code	MARCA / Brand	DESCRIPCIÓN / Descrição / Description
JT-115	M. W. M	SPRINT 4 - 6 CIL.



JT-115-01
Salida turbo
Saída turbo



2608600
Arandela
Arruela (Aluminio)
12 x 18 x 1,5mm



JT-110-03
Paso aceite
Paso óleo



JT-110-02
Base turbo
espárragos/prisioneiro
ø 10mm



2617800
Arandela
Arruela (Aluminio)
16 x 22 x 1,5mm

CÓDIGO / Code	MARCA / Brand	DESCRIPCIÓN / Descrição / Description
JT-118	PEUGEOT	206 - 307 PARTNER 2.0 DIESEL - MOTOR DW10



JT-118-01
Colector a turbo
Coletor ao turbo



JT-118-02
Salida turbo
Saída turbo



JT-118-03
Brida turbo
Flange turbo

JUEGO JUNTAS PARA TURBO COMPRESOR (JT)

ILLINOIS®

Jogo de Juntas para Turbo Compressor / Turbo Compressor Set Gaskets

CÓDIGO / Code	MARCA / Brand	DESCRIPCIÓN / Descrição / Description
JT-141	PEUGEOT/FORD CITROEN	307 HDI 407 TD 2004/... FOCUS C-MAX TDCI 2003/... XSARA PICASSO C4 C5 TD 1,6 - DV6TED4/TD4-G8DA 16V (JUEGO)



JT-141-01
Junta turbo



JT-141-02
Junta turbo



JT-141-03
Junta turbo

CÓDIGO / Code	MARCA / Brand	DESCRIPCIÓN / Descrição / Description
JT-129	TOYOTA	HILUX 2,8 - 3L/3LT CT20/CT26



JT-129-01
Junta turbo



JT-129-02
Junta turbo



JT-129-03
Junta turbo



JT-129-04
Junta turbo

CÓDIGO / Code	MARCA / Brand	DESCRIPCIÓN / Descrição / Description
JT-119	RENAULT	CLIO II KANGOO MEGANE DCI 1,5 - K9K COMMONRAIL DIESEL



JT-119-01
Salida turbo
Saída turbo



JT-119-02
Junta intermedia
Junta intermediária



JT-119-03
Junta lubricación
Junta lubrificação

CÓDIGO / Code	MARCA / Brand	DESCRIPCIÓN / Descrição / Description
JT-120	VOLKSWAGEN	PASSAT 1,9 TDI MOTOR 115PD/PD UI DIESEL



JT-120-01
Salida turbo
Saída turbo



JT-120-02
Cuerpo turbo
Corpo turbo



JT-118-03
Brida turbo
Flange turbo

CÓDIGO / Code	MARCA / Brand	DESCRIPCIÓN / Descrição / Description
JT-123	RENAULT	MEGANE SCENIC CLIO 1,9 DIESEL - F9Q



JT-123-01
Salida turbo
Saída turbo



JT-123-02
Colector turbo
Coletor turbo



JT-123-03
Salida turbo
Saída turbo



JT-123-04
Brida turbo
Flange turbo



2617700
Arandela
Arruela (Cobre)
12 x 16 x 1,5mm

CÓDIGO / Code	MARCA / Brand	DESCRIPCIÓN / Descrição / Description
JT-121	VOLKSWAGEN	PASSAT 1,9 TDI DIESEL



JT-120-01
Salida turbo
Saída turbo



JT-121-01 - 3A0253115
Junta turbo



JT-118-03
Brida turbo
Flange turbo

CÓDIGO / Code	MARCA / Brand	DESCRIPCIÓN / Descrição / Description
JT-155	RENAULT NISSAN	MASTER TRAFIC - 2.5 - G9U PRIMASTAR INTERSTAR



JT-155-01
Salida turbo
Saída turbo



JT-155-02
Colector turbo
Coletor turbo



JT-155-03
Brida aceite
Flange turbo



2635400
Arandela
Arruela (Cobre)
12,5 x 17 x 1,5mm

CÓDIGO / Code	MARCA / Brand	DESCRIPCIÓN / Descrição / Description
JT-143	VOLKSWAGEN	BORA GOLF AUDI A3 SEAT - 1,8 - NAFTA



JT-143-01
Entrada de gases
Entrada de gases

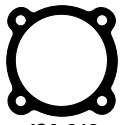

JSA-310
Salida escape
Saída escapamento





JT-118-03
Brida turbo
Flange turbo

JUEGO JUNTAS PARA TURBO COMPRESOR (JT)



Jogo de Juntas para Turbo Compressor / Turbo Compressor Set Gaskets

CÓDIGO / Code	MARCA / Brand	DESCRIPCIÓN / Descrição / Description
JT-151	VOLKSWAGEN	TURBO PASSAT BORA SHARAN A4 A6 - 1.8
  		
<p>JT-151-01 Salida de gases Saída de gases</p> <p>JT-151-02 Entrada de aire Entrada de ar</p> <p>JT-118-03 Brida turbo Flange turbo</p>		

ILLINOIS[®]

JUNTAS
PARA CARBURADOR
ESP

JUNTAS
PARA CARBURADOR
PORT

CARBURETOR
GASKETS
ENG

J B

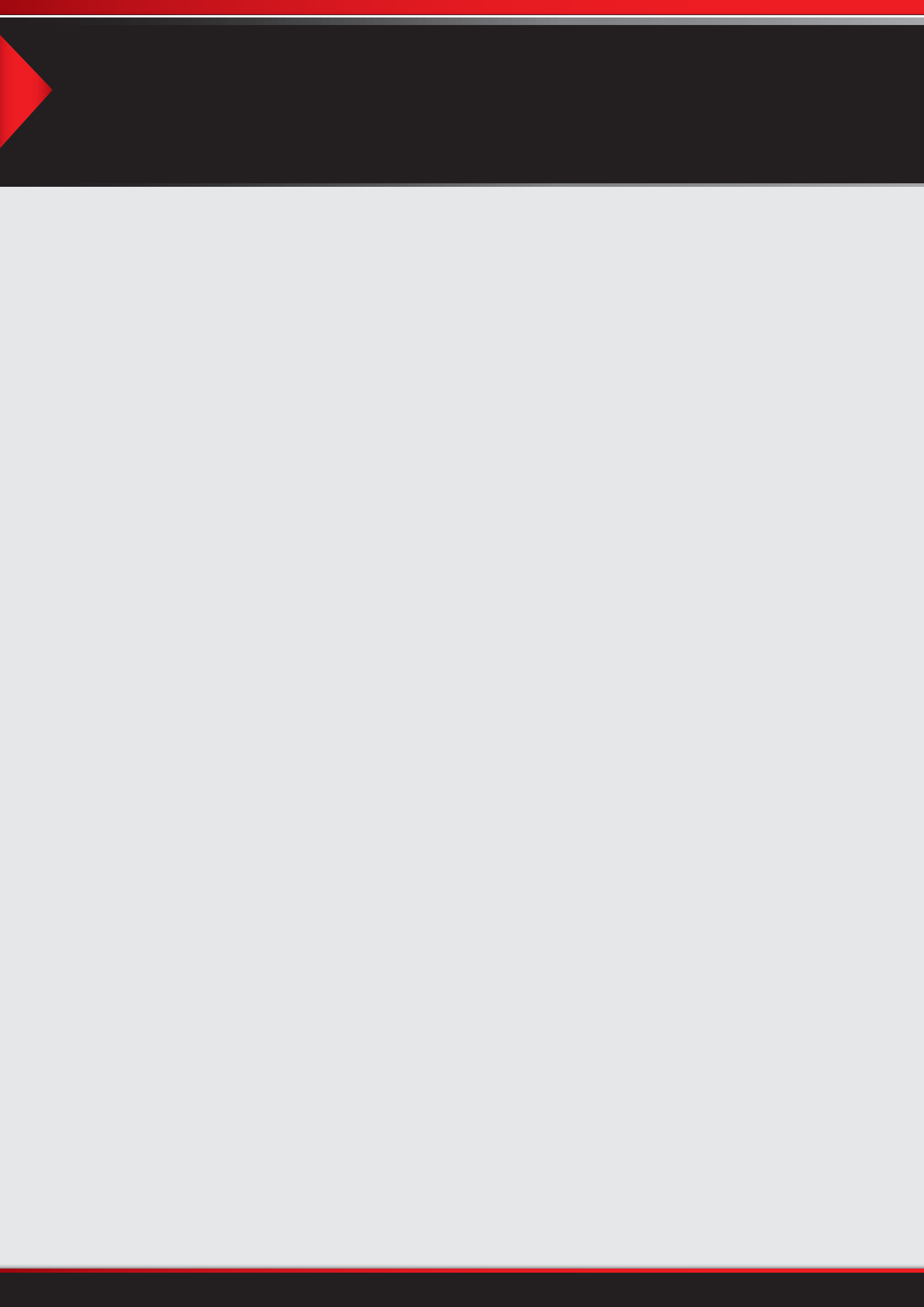

JUEGO JUNTAS PARA CARBURADOR (JB) Jogo de Juntas para Carburador Carburetor Set Gaskets

Orden alfabético / Ordem alfabética
Alphabetical order

REF.	MARCA / BRAND	MODELO / MODEL	PAG.
JB-230	CHEVETTE	1.4 WEBER BRASILEIRO	437
JB-229	CHEVETTE	1.6 S SOLEX BROSOL H34 SERIE - BRASILEIRO	437
JB-111	CHEVROLET	400 - PICK UP - HOLLEY MOT.250	437
JB-113	CHEVROLET	CHEVY MOT.230 - ZENITH GALILEO	437
JB-163	CHEVROLET	CHEVY SERIE 2 COUPE - HOLLEY RX7214A - 2 BOCAS	437
JB-178	CHEVROLET	IMPORTADA SILVERADO CHEYENNE	437
JB-260	CHEVROLET	MONZA BROSOL 2 BOCAS	437
JB-114	CHEVROLET	SPECIAL HOLLEY 1922 CUBA GRANDE	437
JB-264-INY	CHEVROLET	CORSA - PICK UP - ASTRA - ZAFIRA - BOSCH DELFI	437
JB-103	CITROEN	2CV AZAM 66/73	437
JB-166	CITROEN	3CV SOLEX 2A. SERIE	437
JB-104	CITROEN	3CV SOLEX 69/73	437
JB-167	CITROEN	AMI 8 SOLEX 2A. SERIE	438
JB-211	DODGE	1500 1979/... HOLLEY	438
JB-117	DODGE	1500 STROMBERG 150 CDS 71/79	438
JB-185	DODGE	D1500 HOLLEY RX-7034	438
JB-169	DODGE	D1800 HOLLEY RX-7035	438
JB-134	FIAT	125 SOLEX 73/76	438
JB-181	FIAT	128 EUROPA - SOLEX	438
JB-187	FIAT	128 EUROPA - WEBER	438
JB-132	FIAT	128 1/2 SERIE WEBER 32 ICEV	438
JB-168	FIAT	128 IAVA TV1300 SOLEX C34 EIES 2 BOCAS	438
JB-212	FIAT	128 SUPER EUROPA 1.5 - WEBER 32-34 DOBLE BOCA	438
JB-213	FIAT	128 1.5 - SUPER EUROPA SOLEX DOBLE BOCA	438
JB-131	FIAT	128 - 147 WEBER 32 ICEV-CUBA CHICA	439
JB-263	FIAT	128 1/2/3 SERIES - WEBER 32 ICEV	439
JB-171	FIAT	133 - 600S - WEBER ICF 19	439
JB-226	FIAT	147 (1,1/1,3) - REGATTA 100S/2000 WEBER	439
JB-246	FIAT	147 BROSOL SOLEX H32	439
JB-234	FIAT	147 SOLEX H32 DIS	439
JB-123	FIAT	600 E - D - R 750 SOLEX	439
JB-170	FIAT	600 - 750 DER - WEBER 28 ICP	439
JB-122	FIAT	600 - 750 WEBER 28 ICP	439
JB-129	FIAT	1500 COUPE 1600 WEBER	439
JB-128	FIAT	1500 WEBER 2 BOCAS - 28 - 36 DCD1	439
JB-176	FIAT	1600 - 125 WEBER DCHD - DOBLE BOCA	439
JB-130	FIAT	1600 - 125 - SOLEX C34 PAIA2 2 BOCAS	440
JB-215	FIAT	DUNA 1992 SOLEX	440
JB-253-INY	FIAT	DUNA UNO TIPO ELBA 1,6 / VOLKSWAGEN GOLF GL 1,8	440
JB-206	FIAT	DUNA - UNO (1,4/1,5/1,6) WEBER 32-34 TLDE 2 BOCAS	440
JB-251-INY	FIAT	PALIO SIENA INYECCION	440
JB-231	FIAT	REGATTA 85 1,5 WEBER 2 BOCAS	440
JB-214	FIAT	REGATTA 85 5 VELOCIDADES SOLEX	440
JB-207	FIAT	UNO - REGATTA 85 WEBER	440
JB-233	FIAT	UNO 1,6 WEBER 32/34 BRASILEIRO 2 BOCAS	440
JB-216	FIAT	TEMPRA WEBER 2 BOCAS	440
JB-252-INY	FIAT	FIORINO DUNA UNO TEMPRA 2,0 PREMIO UNO MILLE	440
JB-190	FORD	FALCON 3,0 HOLLEY	440
JB-191	FORD	FALCON 3,6 HOLLEY	441

REF.	MARCA / BRAND	MODELO / MODEL	PAG.
JB-183	FORD	FALCON MOT.187/188 - ZENITH GALILEO	441
JB-141	FORD	FALCON - FAIRLANE MOT.221 HOLLEY (BOCA GRANDE)	441
JB-140	FORD	FALCON - HOLLEY - MOT.187/188 (BOCA CHICA)	441
JB-236	FORD	FALCON - PICK UP - MOT.221 - ZENITH GALILEO	441
JB-144	FORD	TAUNUS 2,0 - ZENITH GALILEO	441
JB-197	FORD	TAUNUS GHIA SOLEX	441
JB-203	FORD	ESCORT 1,6 WEBER	441
JB-217	FORD	ESCORT 1,8 - SOLEX - BROSOL - 2 BOCAS	441
JB-200	FORD	SIERRA 1,6 WEBER 2 BOCAS	441
JB-204	FORD	SIERRA 2,3 SOLEX 1987	441
JB-201	FORD	SIERRA GHIA 2,3 - XR4 SOLEX TEIE 2 BOCAS	441
JB-237	FORD	GALAXY 2.0 SOLEX BROSOL 2 BOCAS	442
JB-142	FORD	F100 - F600 8 CIL. HOLLEY 2 BOCAS	442
JB-143	FORD	F100 - FAIRLANE V8 - FALCON SPRINT - HOLLEY 2 BOCAS	442
JB-218	FORD	F100 - FALCON MAX ECONO SOLEX TEIE 2 BOCAS	442
JB-243	ISUZU/CHEV.	LUV 2,3 DLX - PICK UP CHEVROLET	442
JB-148	PEUGEOT	403 - 404 SOLEX C34 1 BOCA	442
JB-174	PEUGEOT	404 - 504 1.6/1.8 - CARESA 1 BOCA	442
JB-219	PEUGEOT	405 GL - SR SOLEX 1433630	442
JB-149	PEUGEOT	504 1,8 SOLEX C34 PAIA 4 2 BOCAS	442
JB-182	PEUGEOT	504 2,0 SL - GR - GR11 - SOLEX C34 2 BOCAS	442
JB-164	PEUGEOT	504 2,0 SOLEX C34 EIES 2 BOCAS	442
JB-247	PEUGEOT	504 GR 1 BOCA 82/83 SOLEX	442
JB-195	PEUGEOT	505 MINSAs	443
JB-193	PEUGEOT	505 SOLEX 2 BOCAS	443
JB-228	PEUGEOT	205 GR - SR - XR WEBER 34	443
JB-153	RENAULT	GORDINI SOLEX 32 PIBT	443
JB-179	RENAULT	R4 - R6 WEBER 30 ICF	443
JB-152	RENAULT	R4L DAUPHINE SOLEX 28 IBT	443
JB-155	RENAULT	R6 SOLEX 70/76	443
JB-240	RENAULT	R9 93/94 SOLEX 32 BIS 1 BOCA	443
JB-223	RENAULT	R9 - R11 WEBER	443
JB-199	RENAULT	R11 TL - 5V 1B SOLEX	443
JB-198	RENAULT	R11 TS - GTS - TURBO WEBER 32 DTR 2 BOCAS	443
JB-250	RENAULT	R12 - R18 GTL 2 BOCAS SOLEX	443
JB-221	RENAULT	R12 1982 SOLEX 2 BOCAS	444
JB-222	RENAULT	R12 1985 SOLEX 2 BOCAS	444
JB-156	RENAULT	R12 SOLEX 1 BOCA EISA 3	444
JB-165	RENAULT	R12 SOLEX C34 1973	444
JB-180	RENAULT	R12 TL 1.4 CARTER RBS 20555	444
JB-239	RENAULT	R12 TL TRAFIC 1.4 HOLLEY GRX 7066B 1 BOCA	444
JB-238	RENAULT	R12 TL WEBER 34 ICH 1 BOCA	444
JB-184	RENAULT	R12 WEBER 32 DIR 2 BOCAS	444
JB-208	RENAULT	R12L WEBER 30 ICFA 1 BOCA	444
JB-205	RENAULT	R18 (2000) SOLEX 2 BOCAS	444
JB-249	RENAULT	R18 2000 1985 SOLEX	444
JB-202	RENAULT	R18 JR. - R12/82 SOLEX	444
JB-192	RENAULT	R18 TX 32 DARA - FUEGO 82 - WEBER 2B	445
JB-194	RENAULT	FUEGO SOLEX	445

REF.	MARCA / BRAND	MODELO / MODEL	PAG.
JB-224	RENAULT	R21 SOLEX	445
JB-248	RENAULT	TRAFIC 1,4 WEBER 30 ICF	445
JB-220	RENAULT	TRAFIC 2,0 HOLLEY	445
JB-227	RENAULT	CLIO RT 1,4 WEBER 2 BOCAS	445
JB-256-INY	RENAULT	CLIO RN RT 1,6	445
JB-255-INY	RENAULT	TWINGO	445
JB-242-INY	RENAULT/PEUG.	JGO.INYECC.ELECTR.MONOPUNTO R-19 / 205	445
JB-175	TORINO	CARTER ABD 2 BOCAS (300 - 380)	445
JB-157	TORINO	HOLLEY ARGELITE 40.40 2 BOCAS	445
JB-162	VALIANT	IV - POLARA - HOLLEY 85G 7003 - CUBA GRANDE	445
JB-188	VOLKSWAGEN	1300 - KOMBI - ESCARABAJO - SOLEX H30 PIC	446
JB-209	VOLKSWAGEN	CARAT CD - GACEL 1,8 - SOLEX - BROSOL	446
JB-196	VOLKSWAGEN	GACEL GL 1983 WEBER 2 BOCAS	446

REF.	MARCA / BRAND	MODELO / MODEL	PAG.
JB-210	VOLKSWAGEN	GOL 1,6 WEBER 2B.1992	446
JB-245	VOLKSWAGEN	GOL SAVEIRO BROSOL	446
JB-241-INY	VOLKSWAGEN	JGO. INYECC. GOL - POINTER MONOPUNTO	446
JB-254-INY	VOLKSWAGEN	POINTER - QUANTUM - CARAT - ORION - GALAXY - VERSALLES - ESCORT 1,6	446
JB-257	VOLKSWAGEN	PASSAT LSE 1,6 SOLEX 2 BOCAS	446
JB-265-INY	VOLKSWAGEN	POLO CLASSIC - CADDY - 1,6/1,8 - MAGNETI - MARELLI	446

JUEGO JUNTAS PARA CARBURADOR (JB)

Jogo de Juntas para Carburador / Carburetor Set Gaskets

ILLINOIS

CÓDIGO / Code	MARCA / Brand	DESCRIPCIÓN / Descrição / Description
JB-230	CHEVETTE	1.4 WEBER BRASILEIRO

CÓDIGO / Code	MARCA / Brand	DESCRIPCIÓN / Descrição / Description
JB-260	CHEVROLET	MONZA BROSOL 2 BOCAS

CÓDIGO / Code	MARCA / Brand	DESCRIPCIÓN / Descrição / Description
JB-229	CHEVETTE	1.6 S SOLEX BROSOL H34 SERIE - BRASILEIRO

CÓDIGO / Code	MARCA / Brand	DESCRIPCIÓN / Descrição / Description
JB-114	CHEVROLET	SPECIAL HOLLEY 1922 CUBA GRANDE

CÓDIGO / Code	MARCA / Brand	DESCRIPCIÓN / Descrição / Description
JB-111	CHEVROLET	400 - PICK UP - HOLLEY MOT. 250

CÓDIGO / Code	MARCA / Brand	DESCRIPCIÓN / Descrição / Description
JB-264-INY	CHEVROLET	CORSA - PICK UP - ASTRA ZAFIRA - BOSCH DELFI

CÓDIGO / Code	MARCA / Brand	DESCRIPCIÓN / Descrição / Description
JB-113	CHEVROLET	CHEVY MOT. 230 ZENITH GALILEO

CÓDIGO / Code	MARCA / Brand	DESCRIPCIÓN / Descrição / Description
JB-103	CITROEN	2CV AZAM 66/73

CÓDIGO / Code	MARCA / Brand	DESCRIPCIÓN / Descrição / Description
JB-163	CHEVROLET	CHEVY SERIE 2 COUPE HOLLEY RX7214A 2 BOCAS

CÓDIGO / Code	MARCA / Brand	DESCRIPCIÓN / Descrição / Description
JB-166	CITROEN	3CV SOLEX 2A. SERIE

CÓDIGO / Code	MARCA / Brand	DESCRIPCIÓN / Descrição / Description
JB-178	CHEVROLET	IMPORTADA SILVERADO CHEYENNE

CÓDIGO / Code	MARCA / Brand	DESCRIPCIÓN / Descrição / Description
JB-104	CITROEN	3CV SOLEX 69/73

JUEGO JUNTAS PARA CARBURADOR (JB)

Jogo de Juntas para Carburador / Carburetor Set Gaskets



CÓDIGO / Code	MARCA / Brand	DESCRIPCIÓN / Descrição / Description
JB-167	CITROEN	AMI 8 SOLEX 2A. SERIE



CÓDIGO / Code	MARCA / Brand	DESCRIPCIÓN / Descrição / Description
JB-181	FIAT	128 EUROPA - SOLEX

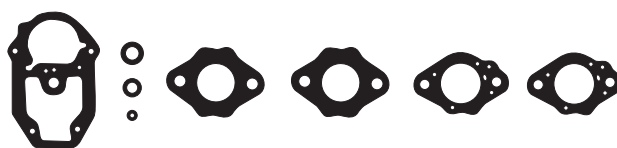

CÓDIGO / Code	MARCA / Brand	DESCRIPCIÓN / Descrição / Description
JB-211	DODGE	1500 1979/... HOLLEY



CÓDIGO / Code	MARCA / Brand	DESCRIPCIÓN / Descrição / Description
JB-187	FIAT	128 EUROPA - WEBER

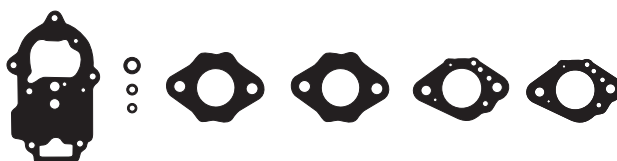

CÓDIGO / Code	MARCA / Brand	DESCRIPCIÓN / Descrição / Description
JB-117	DODGE	1500 STROMBERG 150 CDS 71/79



CÓDIGO / Code	MARCA / Brand	DESCRIPCIÓN / Descrição / Description
JB-132	FIAT	128 1/2 SERIE WEBER 32 ICEV

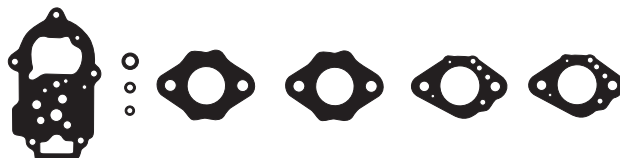

CÓDIGO / Code	MARCA / Brand	DESCRIPCIÓN / Descrição / Description
JB-185	DODGE	D1500 HOLLEY RX-7034



CÓDIGO / Code	MARCA / Brand	DESCRIPCIÓN / Descrição / Description
JB-168	FIAT	128 IAVA TV1300 SOLEX C34 EIES 2 BOCAS



CÓDIGO / Code	MARCA / Brand	DESCRIPCIÓN / Descrição / Description
JB-169	DODGE	D1800 HOLLEY RX-7035



CÓDIGO / Code	MARCA / Brand	DESCRIPCIÓN / Descrição / Description
JB-212	FIAT	128 SUPER EUROPA 1.5 - WEBER 32 - 34 DOBLE BOCA



CÓDIGO / Code	MARCA / Brand	DESCRIPCIÓN / Descrição / Description
JB-134	FIAT	125 SOLEX 73/76



CÓDIGO / Code	MARCA / Brand	DESCRIPCIÓN / Descrição / Description
JB-213	FIAT	128 1.5 - SUPER EUROPA SOLEX DOBLE BOCA



JUEGO JUNTAS PARA CARBURADOR (JB)

Jogo de Juntas para Carburador / Carburetor Set Gaskets

ILLINOIS

CÓDIGO / Code	MARCA / Brand	DESCRIPCIÓN / Descrição / Description
JB-131	FIAT	128 - 147 WEBER 32 ICEV - CUBA CHICA

CÓDIGO / Code	MARCA / Brand	DESCRIPCIÓN / Descrição / Description
JB-123	FIAT	600 E - D - R 750 SOLEX

CÓDIGO / Code	MARCA / Brand	DESCRIPCIÓN / Descrição / Description
JB-263	FIAT	128 1/2/3 SERIE WEBER 32 ICEV TODOS

CÓDIGO / Code	MARCA / Brand	DESCRIPCIÓN / Descrição / Description
JB-170	FIAT	600 - 750 DER - WEBER 28 ICP

CÓDIGO / Code	MARCA / Brand	DESCRIPCIÓN / Descrição / Description
JB-171	FIAT	133 - 600S - WEBER ICF 19

CÓDIGO / Code	MARCA / Brand	DESCRIPCIÓN / Descrição / Description
JB-122	FIAT	600 - 750 WEBER 28 ICP

CÓDIGO / Code	MARCA / Brand	DESCRIPCIÓN / Descrição / Description
JB-226	FIAT	147 (1,1/1,3) - REGATTA 100S/2000 WEBER

CÓDIGO / Code	MARCA / Brand	DESCRIPCIÓN / Descrição / Description
JB-129	FIAT	1500 COUPE 1600 WEBER

CÓDIGO / Code	MARCA / Brand	DESCRIPCIÓN / Descrição / Description
JB-246	FIAT	147 BROSOL SOLEX H32

CÓDIGO / Code	MARCA / Brand	DESCRIPCIÓN / Descrição / Description
JB-128	FIAT	1500 WEBER 2 BOCAS - 28 - 36 DCD1

CÓDIGO / Code	MARCA / Brand	DESCRIPCIÓN / Descrição / Description
JB-234	FIAT	147 SOLEX H32 DIS

CÓDIGO / Code	MARCA / Brand	DESCRIPCIÓN / Descrição / Description
JB-176	FIAT	1600 - 125 WEBER DCHD - DOBLE BOCA

JUEGO JUNTAS PARA CARBURADOR (JB)

Jogo de Juntas para Carburador / Carburetor Set Gaskets



CÓDIGO / Code	MARCA / Brand	DESCRIPCIÓN / Descrição / Description
JB-130	FIAT	1600 - 125 - SOLEX C34 PAIA2 2 BOCAS

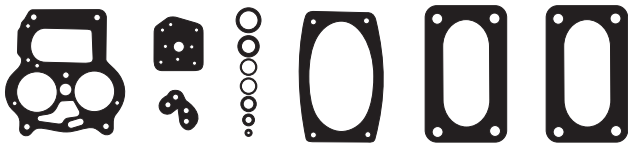

CÓDIGO / Code	MARCA / Brand	DESCRIPCIÓN / Descrição / Description
JB-214	FIAT	REGATTA 85 5 VELOC. SOLEX

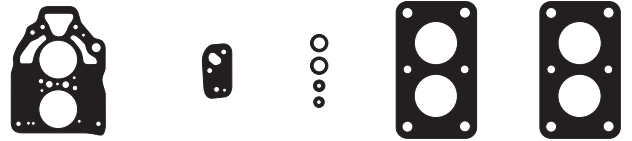

CÓDIGO / Code	MARCA / Brand	DESCRIPCIÓN / Descrição / Description
JB-215	FIAT	DUNA 1992 (SOLEX)



CÓDIGO / Code	MARCA / Brand	DESCRIPCIÓN / Descrição / Description
JB-207	FIAT	UNO - REGATTA 85 WEBER

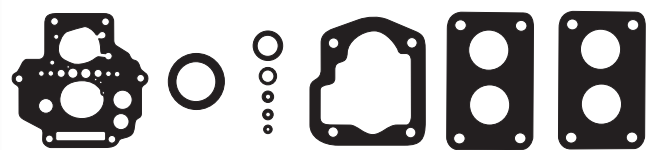

CÓDIGO / Code	MARCA / Brand	DESCRIPCIÓN / Descrição / Description
JB-253-INY	FIAT	DUNA UNO TIPO ELBA 1,6 VOLKSWAGEN GOLF GL 1,8



CÓDIGO / Code	MARCA / Brand	DESCRIPCIÓN / Descrição / Description
JB-233	FIAT	UNO 1,6 WEBER 32/34 BRASILEIRO 2 BOCAS



CÓDIGO / Code	MARCA / Brand	DESCRIPCIÓN / Descrição / Description
JB-206	FIAT	DUNA-UNO (1,4/1,5/1,6) WEBER 32 - 34 TLDE 2 BOCAS



CÓDIGO / Code	MARCA / Brand	DESCRIPCIÓN / Descrição / Description
JB-216	FIAT	TEMPRA (WEBER 2 BOCAS)

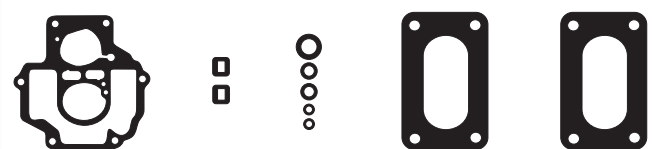

CÓDIGO / Code	MARCA / Brand	DESCRIPCIÓN / Descrição / Description
JB-251-INY	FIAT	PALIO SIENA INYECCION



CÓDIGO / Code	MARCA / Brand	DESCRIPCIÓN / Descrição / Description
JB-252-INY	FIAT	FIORINO DUNA UNO TEMPRA 2,0 PREMIO UNO MILLE



CÓDIGO / Code	MARCA / Brand	DESCRIPCIÓN / Descrição / Description
JB-231	FIAT	REGATTA 85 1,5 WEBER 2 BOCAS



CÓDIGO / Code	MARCA / Brand	DESCRIPCIÓN / Descrição / Description
JB-190	FORD	FALCON 3,0 HOLLEY



JUEGO JUNTAS PARA CARBURADOR (JB)

Jogo de Juntas para Carburador / Carburetor Set Gaskets

ILLINOIS®

CÓDIGO / Code	MARCA / Brand	DESCRIPCIÓN / Descrição / Description
JB-191	FORD	FALCON 3,6 HOLLEY

CÓDIGO / Code	MARCA / Brand	DESCRIPCIÓN / Descrição / Description
JB-197	FORD	TAUNUS GHIA SOLEX

CÓDIGO / Code	MARCA / Brand	DESCRIPCIÓN / Descrição / Description
JB-183	FORD	FALCON MOT.187/188 ZENITH GALILEO

CÓDIGO / Code	MARCA / Brand	DESCRIPCIÓN / Descrição / Description
JB-203	FORD	ESCORT 1,6 WEBER

CÓDIGO / Code	MARCA / Brand	DESCRIPCIÓN / Descrição / Description
JB-141	FORD	FALCON - FAIRLANE MOT. 221 HOLLEY (BOCA GRANDE)

CÓDIGO / Code	MARCA / Brand	DESCRIPCIÓN / Descrição / Description
JB-217	FORD	ESCORT 1,8 - SOLEX - BROSOL 2 BOCAS

CÓDIGO / Code	MARCA / Brand	DESCRIPCIÓN / Descrição / Description
JB-140	FORD	FALCON - MOT. 187/188 HOLLEY (BOCA CHICA)

CÓDIGO / Code	MARCA / Brand	DESCRIPCIÓN / Descrição / Description
JB-200	FORD	SIERRA 1,6 WEBER 2 BOCAS

CÓDIGO / Code	MARCA / Brand	DESCRIPCIÓN / Descrição / Description
JB-236	FORD	FALCON - PICK UP - MOT. 221 ZENITH GALILEO

CÓDIGO / Code	MARCA / Brand	DESCRIPCIÓN / Descrição / Description
JB-204	FORD	SIERRA 2,3 SOLEX 1987

CÓDIGO / Code	MARCA / Brand	DESCRIPCIÓN / Descrição / Description
JB-144	FORD	TAUNUS 2,0 - ZENITH GALILEO

CÓDIGO / Code	MARCA / Brand	DESCRIPCIÓN / Descrição / Description
JB-201	FORD	SIERRA GHIA 2,3 - XR4 SOLEX TEIE 2 BOCAS

JUEGO JUNTAS PARA CARBURADOR (JB)

Jogo de Juntas para Carburador / Carburetor Set Gaskets



CÓDIGO / Code	MARCA / Brand	DESCRIPCIÓN / Descrição / Description
JB-237	FORD	GALAXY 2.0 SOLEX BROSOL 2 BOCAS

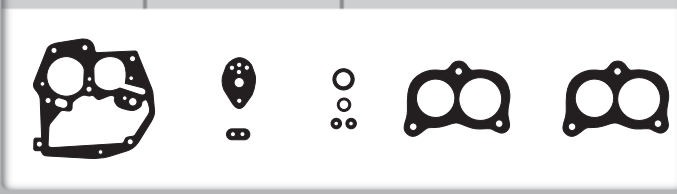

CÓDIGO / Code	MARCA / Brand	DESCRIPCIÓN / Descrição / Description
JB-174	PEUGEOT	404 - 504 1,6/1,8 - CARESA 1 BOCA

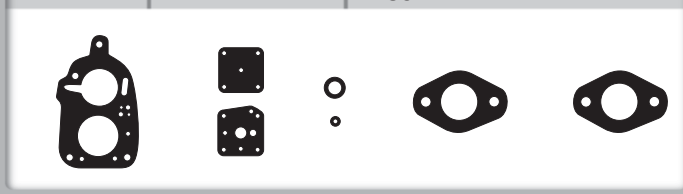

CÓDIGO / Code	MARCA / Brand	DESCRIPCIÓN / Descrição / Description
JB-142	FORD	F100 - F600 8 CIL. HOLLEY 2 BOCAS

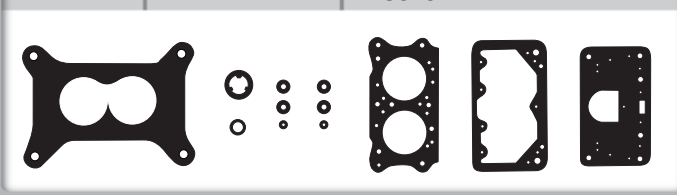

CÓDIGO / Code	MARCA / Brand	DESCRIPCIÓN / Descrição / Description
JB-219	PEUGEOT	405 GL - SR SOLEX 1433630

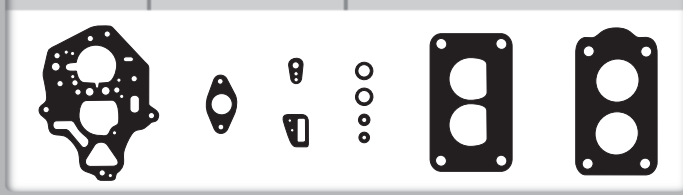

CÓDIGO / Code	MARCA / Brand	DESCRIPCIÓN / Descrição / Description
JB-143	FORD	F100 - FAIRLANE V8 - FALCON SPRINT - HOLLEY 2 BOCAS

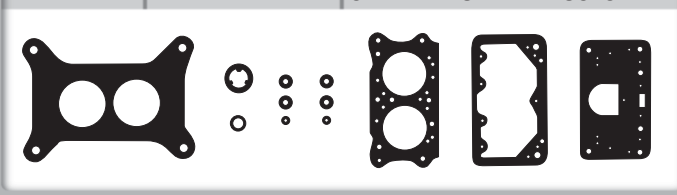

CÓDIGO / Code	MARCA / Brand	DESCRIPCIÓN / Descrição / Description
JB-149	PEUGEOT	504 1,8 SOLEX C34 PAIA 4 2 BOCAS

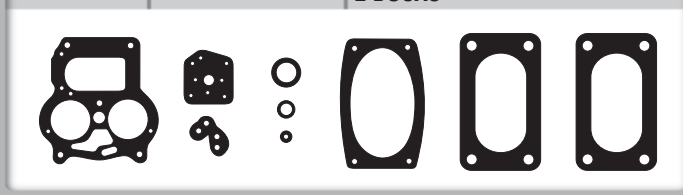

CÓDIGO / Code	MARCA / Brand	DESCRIPCIÓN / Descrição / Description
JB-218	FORD	F100 - FALCON MAX ECONO SOLEX TEIE 2 BOCAS

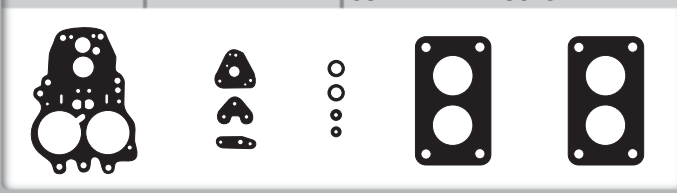

CÓDIGO / Code	MARCA / Brand	DESCRIPCIÓN / Descrição / Description
JB-182	PEUGEOT	504 2,0 SL - GR - GRIL SOLEX C34 2 BOCAS



CÓDIGO / Code	MARCA / Brand	DESCRIPCIÓN / Descrição / Description
JB-243	ISUZU CHEVROLET	LUV 2,3 DLX - PICK UP CHEVROLET

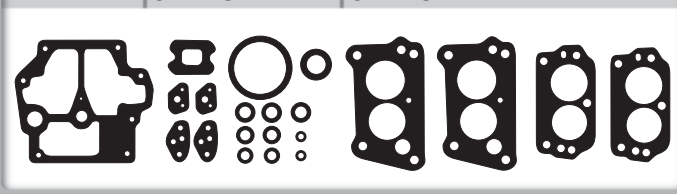

CÓDIGO / Code	MARCA / Brand	DESCRIPCIÓN / Descrição / Description
JB-164	PEUGEOT	504 2,0 SOLEX C34 EIES 2 BOCAS



CÓDIGO / Code	MARCA / Brand	DESCRIPCIÓN / Descrição / Description
JB-148	PEUGEOT	403 - 404 SOLEX C34 1 BOCA



CÓDIGO / Code	MARCA / Brand	DESCRIPCIÓN / Descrição / Description
JB-247	PEUGEOT	504 GR 1 BOCA 82/83 SOLEX

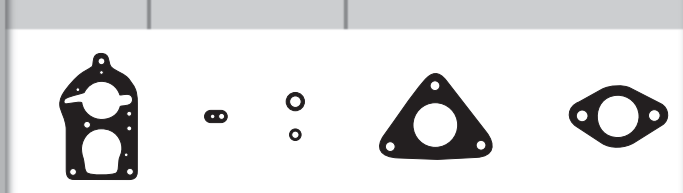

JUEGO JUNTAS PARA CARBURADOR (JB)

Jogo de Juntas para Carburador / Carburetor Set Gaskets

ILLINOIS

CÓDIGO / Code	MARCA / Brand	DESCRIPCIÓN / Descrição / Description
JB-195	PEUGEOT	505 MINSA

CÓDIGO / Code	MARCA / Brand	DESCRIPCIÓN / Descrição / Description
JB-155	RENAULT	R6 SOLEX 70/76

CÓDIGO / Code	MARCA / Brand	DESCRIPCIÓN / Descrição / Description
JB-193	PEUGEOT	505 SOLEX 2 BOCAS

CÓDIGO / Code	MARCA / Brand	DESCRIPCIÓN / Descrição / Description
JB-240	RENAULT	R9 93/94 SOLEX 32 BIS 1 BOCA

CÓDIGO / Code	MARCA / Brand	DESCRIPCIÓN / Descrição / Description
JB-228	PEUGEOT	205 GR - SR - XR WEBER 34

CÓDIGO / Code	MARCA / Brand	DESCRIPCIÓN / Descrição / Description
JB-223	RENAULT	R9 - R11 WEBER

CÓDIGO / Code	MARCA / Brand	DESCRIPCIÓN / Descrição / Description
JB-153	RENAULT	GORDINI SOLEX 32 PIBT

CÓDIGO / Code	MARCA / Brand	DESCRIPCIÓN / Descrição / Description
JB-199	RENAULT	R11 TL - 5V 1B SOLEX

CÓDIGO / Code	MARCA / Brand	DESCRIPCIÓN / Descrição / Description
JB-179	RENAULT	R4 - R6 WEBER 30 ICF

CÓDIGO / Code	MARCA / Brand	DESCRIPCIÓN / Descrição / Description
JB-198	RENAULT	R11 TS - GTS - TURBO WEBER 32 DTR 2 BOCAS

CÓDIGO / Code	MARCA / Brand	DESCRIPCIÓN / Descrição / Description
JB-152	RENAULT	R4L DAUPHINE SOLEX 28 IBT

CÓDIGO / Code	MARCA / Brand	DESCRIPCIÓN / Descrição / Description
JB-250	RENAULT	R12 18 GTL 2 BOCAS SOLEX

JUEGO JUNTAS PARA CARBURADOR (JB)

Jogo de Juntas para Carburador / Carburetor Set Gaskets



CÓDIGO / Code	MARCA / Brand	DESCRIPCIÓN / Descrição / Description
JB-221	RENAULT	R12 1982 SOLEX 2 BOCAS

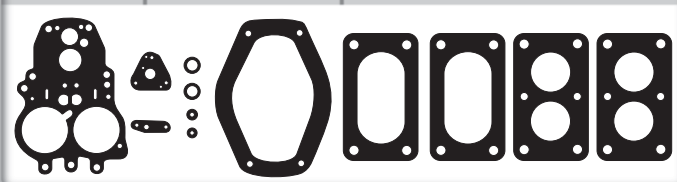

CÓDIGO / Code	MARCA / Brand	DESCRIPCIÓN / Descrição / Description
JB-238	RENAULT	R12 TL WEBER 34 ICH 1 BOCA

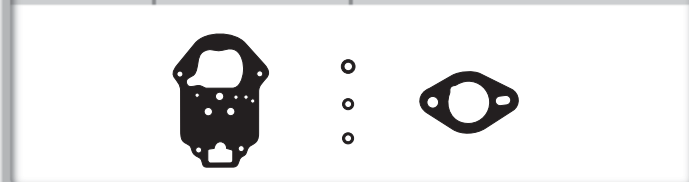

CÓDIGO / Code	MARCA / Brand	DESCRIPCIÓN / Descrição / Description
JB-222	RENAULT	R12 1985 SOLEX 2 BOCAS



CÓDIGO / Code	MARCA / Brand	DESCRIPCIÓN / Descrição / Description
JB-184	RENAULT	R12 WEBER 32 DIR 2 BOCAS

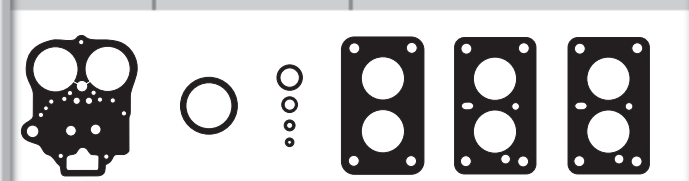

CÓDIGO / Code	MARCA / Brand	DESCRIPCIÓN / Descrição / Description
JB-156	RENAULT	R12 SOLEX 1 BOCA EISA 3



CÓDIGO / Code	MARCA / Brand	DESCRIPCIÓN / Descrição / Description
JB-208	RENAULT	R12L WEBER 30 ICFA 1 BOCA



CÓDIGO / Code	MARCA / Brand	DESCRIPCIÓN / Descrição / Description
JB-165	RENAULT	R12 SOLEX C34 1973



CÓDIGO / Code	MARCA / Brand	DESCRIPCIÓN / Descrição / Description
JB-205	RENAULT	R18 (2000) SOLEX 2 BOCAS

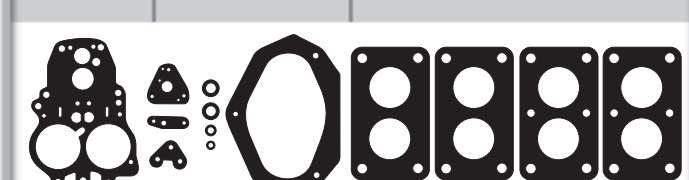

CÓDIGO / Code	MARCA / Brand	DESCRIPCIÓN / Descrição / Description
JB-180	RENAULT	R12 TL 1.4 CARTER RBS 20555



CÓDIGO / Code	MARCA / Brand	DESCRIPCIÓN / Descrição / Description
JB-249	RENAULT	R18 2000 1985 SOLEX

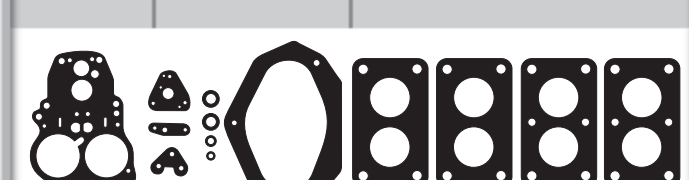

CÓDIGO / Code	MARCA / Brand	DESCRIPCIÓN / Descrição / Description
JB-239	RENAULT	R12 TL TRAFIC 1.4 HOLLEY GRX 7066B 1 BOCA



CÓDIGO / Code	MARCA / Brand	DESCRIPCIÓN / Descrição / Description
JB-202	RENAULT	R18 JR. - R12/82 SOLEX



JUEGO JUNTAS PARA CARBURADOR (JB)

Jogo de Juntas para Carburador / Carburetor Set Gaskets

ILLINOIS



CÓDIGO / Code	MARCA / Brand	DESCRIPCIÓN / Descrição / Description
JB-192	RENAULT	R18 TX 32 DARA - FUEGO 82 WEBER 2B

CÓDIGO / Code	MARCA / Brand	DESCRIPCIÓN / Descrição / Description
JB-256-INY	RENAULT	CLIO RN RT 1,6

CÓDIGO / Code	MARCA / Brand	DESCRIPCIÓN / Descrição / Description
JB-194	RENAULT	FUEGO - SOLEX

CÓDIGO / Code	MARCA / Brand	DESCRIPCIÓN / Descrição / Description
JB-255-INY	RENAULT	TWINGO

CÓDIGO / Code	MARCA / Brand	DESCRIPCIÓN / Descrição / Description
JB-224	RENAULT	R21 SOLEX

CÓDIGO / Code	MARCA / Brand	DESCRIPCIÓN / Descrição / Description
JB-242-INY	RENAULT PEUGEOT	JGO. INYECC. ELECTR. MONOPUNTO R-19 / 205

CÓDIGO / Code	MARCA / Brand	DESCRIPCIÓN / Descrição / Description
JB-248	RENAULT	TRAFIC 1,4 WEBER 30 ICF

CÓDIGO / Code	MARCA / Brand	DESCRIPCIÓN / Descrição / Description
JB-175	TORINO	CARTER ABD 2 BOCAS (300 - 380)

CÓDIGO / Code	MARCA / Brand	DESCRIPCIÓN / Descrição / Description
JB-220	RENAULT	TRAFIC 2,0 HOLLEY

CÓDIGO / Code	MARCA / Brand	DESCRIPCIÓN / Descrição / Description
JB-157	TORINO	HOLLEY ARGELITE 40.40 2 BOCAS

CÓDIGO / Code	MARCA / Brand	DESCRIPCIÓN / Descrição / Description
JB-227	RENAULT	CLIO RT 1,4 WEBER 2 BOCAS

CÓDIGO / Code	MARCA / Brand	DESCRIPCIÓN / Descrição / Description
JB-162	VALIANT	IV - POLARA - HOLLEY 85G 7003 CUBA GRANDE

JUEGO JUNTAS PARA CARBURADOR (JB)

Jogo de Juntas para Carburador / Carburetor Set Gaskets



CÓDIGO / Code	MARCA / Brand	DESCRIPCIÓN / Descrição / Description
JB-188	VOLKSWAGEN	1300 - KOMBI - ESCARABAJO SOLEX H30 PIC

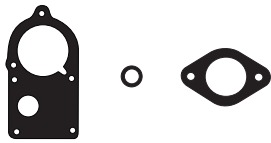

CÓDIGO / Code	MARCA / Brand	DESCRIPCIÓN / Descrição / Description
JB-254-INY	VOLKSWAGEN	ORION - QUANTUM - CARAT - VERSALLES GALAXY - POINTER - ESCORT 1,6



CÓDIGO / Code	MARCA / Brand	DESCRIPCIÓN / Descrição / Description
JB-209	VOLKSWAGEN	CARAT CD - GACEL 1,8 - SOLEX BROSOL



CÓDIGO / Code	MARCA / Brand	DESCRIPCIÓN / Descrição / Description
JB-257	VOLKSWAGEN	PASSAT LSE 1,6 SOLEX 2 BOCAS

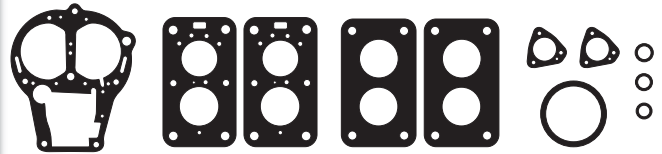

CÓDIGO / Code	MARCA / Brand	DESCRIPCIÓN / Descrição / Description
JB-196	VOLKSWAGEN	GACEL GL 1983 WEBER 2 BOCAS



CÓDIGO / Code	MARCA / Brand	DESCRIPCIÓN / Descrição / Description
JB-265-INY	VOLKSWAGEN	POLO CLASSIC - CADDY - 1,6/1,8 MAGNETI - MARELLI



CÓDIGO / Code	MARCA / Brand	DESCRIPCIÓN / Descrição / Description
JB-210	VOLKSWAGEN	GOL 1,6 WEBER 2B.1992



CÓDIGO / Code	MARCA / Brand	DESCRIPCIÓN / Descrição / Description
JB-245	VOLKSWAGEN	GOL SAVEIRO BROSOL



CÓDIGO / Code	MARCA / Brand	DESCRIPCIÓN / Descrição / Description
JB-241-INY	VOLKSWAGEN	JGO. INYECC. GOL - POINTER MONOPUNTO

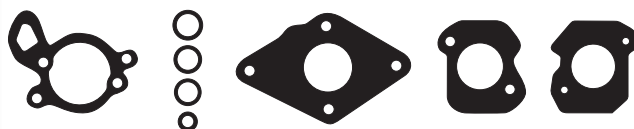

JUNTAS PARA
DIFERENCIAL Y PALIER

ESP

JUNTAS PARA
DIFERENCIAL E
PONTA DE EIXO

PORT

DIFERENTIAL AND
BEARING **GASKETS**

ENG

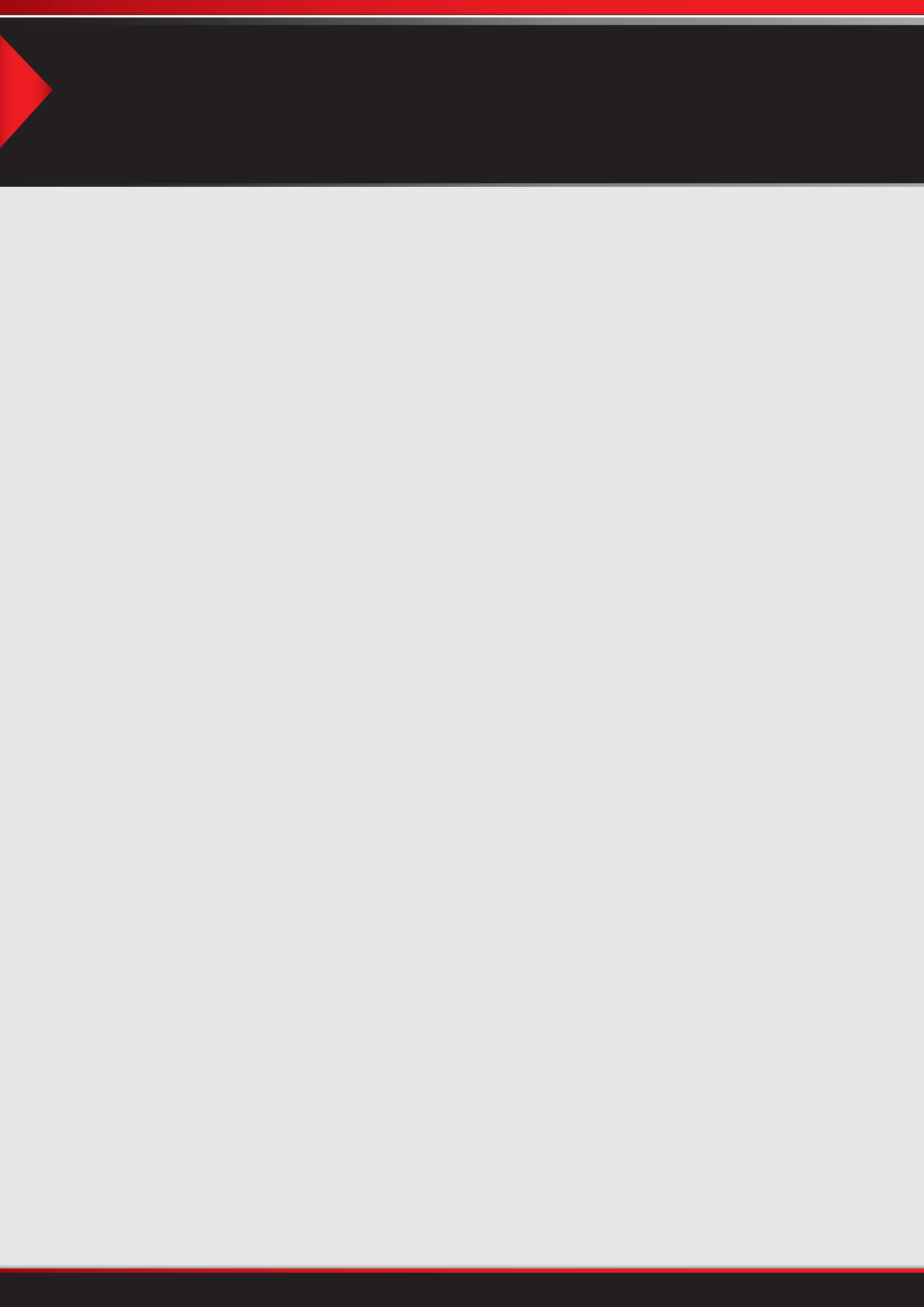

JUNTAS PARA DIFERENCIAL Y PALIER Juntas para Diferencial e Ponta de Eixo Differential and Bearing Gaskets

Orden alfabético / Ordem alfabética
Alphabetical order

REF.	MARCA / BRAND	MODELO / MODEL	PAG.
1087000	BED/CHEV./DODGE/FORD	3009197 (PALIER)	451
1086700	BEDFORD/CHEV./FORD	EATON 162 GRANDE (JUEGO DIFERENCIAL)	451
1086800	BEDFORD/CHEV./FORD	EATON 162 GRANDE 201019 (TAPA DIFERENCIAL)	451
1086900	BEDFORD/CHEV./FORD	EATON 162 GRANDE 50364 (NUCLEO DIFERENCIAL)	451
1086600	CHEVROLET	B47Z - 1001.A (PALIER)	451
1085000	CHEVROLET	DANA 44 (HEXAGONAL) CHEVROLET 400 (DIFERENCIAL)	451
1085200	CHEVROLET	DANA 44 802556 - 2017354 (DIFERENCIAL)	451
1158100	CHEVROLET	DANA 46 (DIFERENCIAL)	451
1066900	CHEVROLET	DANA 70 - 350 (DIFERENCIAL)	451
1086300	CHEVROLET	EATON 132 CHICO (JUEGO DIFERENCIAL)	451
1086500	CHEVROLET	EATON 132 CHICO (NUCLEO DIFERENCIAL)	451
1086400	CHEVROLET	EATON 132 CHICO (TAPA DIFERENCIAL)	451
1085600	CHEVROLET	EATON 200.272 SERIE 250 (DIFERENCIAL)	451
1127000	CHEVROLET	SILVERADO CHEYENE (DIFERENCIAL)	451
1085300	DI TELLA	12081 (DIFERENCIAL)	452
1085400	DODGE	71302502 DODGE 1500 (DIFERENCIAL)	452
1085100	DODGE	DANA 30 - B4C9 DZ - 4036A (DIFERENCIAL)	452
1118900	DODGE/M. BENZ	EATON 182 (JUEGO DIFERENCIAL)	452
1085500	DODGE/M. BENZ	EATON 182 51266 - DD1000 (NUCLEO DIFERENCIAL)	452
1121000	DODGE/M. BENZ	EATON 182 TAPA - CG (DIFERENCIAL)	452
1085700	FIAT	405.9702 TAPA P/1500 (DIFERENCIAL)	452
1085800	FIAT	4615850 TAPA P/619 N1 (DIFERENCIAL)	452
1104000	FIAT	572255 SUPERIOR TAPA DIFERENCIAL 780R 1962/69 R55 R60 1955	452
1149900	FORD	350 (PALIER)	452
1127100	FORD	RANGER (NUCLEO DIFERENCIAL)	452
1132100	FORD	RTPJP1 F100 - 350 HASTA 1981 (PALIER)	452
1132200	FORD	RTPJP2 F100 - 350 DESDE 1981 (PALIER)	452
1096300	JOHN DEERE	R40947 TAPA DIFERENCIAL 1420	452
1132300	JOHN DEERE	T21641 TAPA DIFERENCIAL 2140/2530/2730/3350	452
1145200	M.BENZ	3023510180 OM1315 al 1420 COLECTIVO (DIFERENCIAL)	453
1087800	M.BENZ	1517 - 3173510280(DIFERENCIAL)	453
1085900	M.BENZ	1112 - 1114 - 3223510080 (DIFERENCIAL)	453
1132700	M.BENZ	1517 - 3273560180 (PALIER)	453
1087100	M.BENZ	993413510580 (PALIER DE CHAPA)	453
1073100	M.BENZ	3500 - OM312 (DIFERENCIAL)	453
1087200	M.BENZ	1114 - 0140 - OM352 - MOTOR ELECTRICO ALTA Y BAJA (JUEGO DIFERENCIAL)	453
1005900	M.BENZ	DIFERENCIAL CUBO DE RUEDA 1634 - 1938M ELECTRONICO	453
1011900	PEUGEOT	504- 505 HIPOIDAL (JUEGO DIFERENCIAL)	453
1120800	PEUGEOT	JUNTA PALIER 504-505	453
1086000	PEUGEOT	404 1969 (JUEGO DIFERENCIAL)	453
1086100	RASTROJERO	42 HP (DIFERENCIAL CHICO)	453
1086200	RASTROJERO	42 HP (DIFERENCIAL GRANDE)	453
1140900	ROCKWELL	FORD F1000 - CHEVROLET C20/D20 (DIFERENCIAL CHICO)	454
1141000	ROCKWELL	FORD F7000/14000 - CHEVROLET 14000 (DIFERENCIAL GRANDE)	454

**JUNTAS PARA DIFERENCIAL Y PALIER****Juntas para Diferencial e Ponta de Eixo
Differential and Bearing Gaskets***Orden alfabético / Ordem alfabética
Alphabetical order*

REF.	MARCA / BRAND	MODELO / MODEL	PAG.
1166000	SCANIA	182.503 653 - 752 SCANIA 111 - MICRO K112 (DIFERENCIAL)	454
1157700	SCANIA	308.097 770 SCANIA 112/113 (DIFERENCIAL)	454
1155500	SCANIA	527973 TAPA CREMALLERA DOBLE 112-113-L75-L76-110-111	454

JUNTAS PARA DIFERENCIAL Y PALIER

Juntas para Diferencial e Ponta de Eixo / Differential and Bearing Set Gaskets

ILLINOIS®

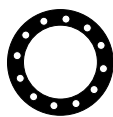

CÓDIGO/Code	1087000
MARCA/Brand	BED./CHEV./DODGE/FORD
DESCRIPCIÓN Descrição Description	3009197 (PALIER)

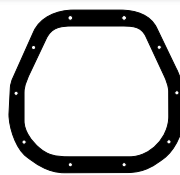

CÓDIGO/Code	1158100
MARCA/Brand	CHEVROLET
DESCRIPCIÓN Descrição Description	DANA 46 (DIFERENCIAL)

CÓDIGO / Code	MARCA / Brand	DESCRIPCIÓN / Descrição / Description
1086700	BEDFORD/CHEV. FORD	EATON 162 GRANDE (JUEGO DIFERENCIAL)

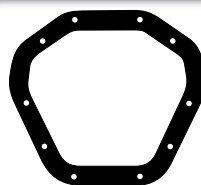
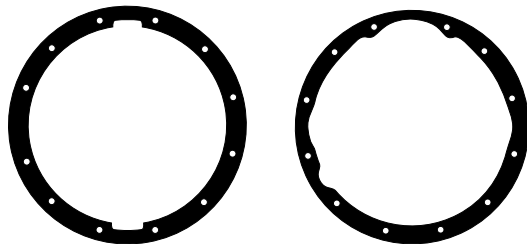

CÓDIGO/Code	1066900
MARCA/Brand	CHEVROLET
DESCRIPCIÓN Descrição Description	DANA 70 - 350 (DIFERENCIAL)

CÓDIGO / Code	MARCA / Brand	DESCRIPCIÓN / Descrição / Description
1086300	CHEVROLET	EATON 132 CHICO (JUEGO DIFERENCIAL)

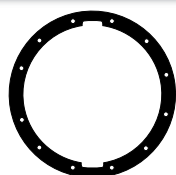
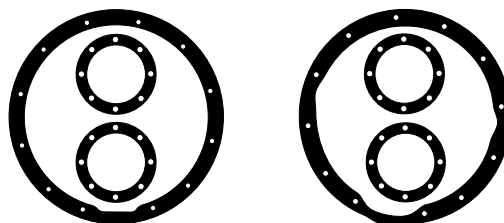

CÓDIGO/Code	1086800
MARCA/Brand	BEDFORD/CHEV./FORD
DESCRIPCIÓN Descrição Description	EATON 162 GRANDE 201019 (TAPA DIFERENCIAL)

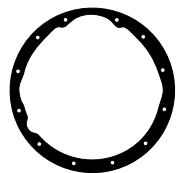

CÓDIGO/Code	1086900
MARCA/Brand	BEDFORD/CHEV./FORD
DESCRIPCIÓN Descrição Description	EATON 162 GRANDE 50364 (NUCLEO DIFERENCIAL)

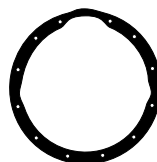

CÓDIGO/Code	1086500
MARCA/Brand	CHEVROLET
DESCRIPCIÓN Descrição Description	EATON 132 CHICO (NUCLEO DIFERENCIAL)

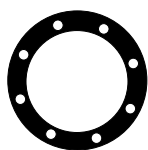

CÓDIGO/Code	1086600
MARCA/Brand	CHEVROLET
DESCRIPCIÓN Descrição Description	B47Z-1001.A (PALIER)

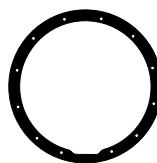

CÓDIGO/Code	1086400
MARCA/Brand	CHEVROLET
DESCRIPCIÓN Descrição Description	EATON 132 CHICO (TAPA DIFERENCIAL)

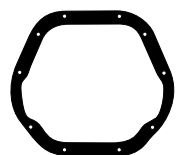

CÓDIGO/Code	1085000
MARCA/Brand	CHEVROLET
DESCRIPCIÓN Descrição Description	DANA 44 (HEXAGONAL) CHEVROLET 400 (DIFERENCIAL)

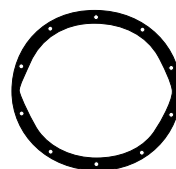

CÓDIGO/Code	1085600
MARCA/Brand	CHEVROLET
DESCRIPCIÓN Descrição Description	EATON 200.272 SERIE 250 (DIFERENCIAL)

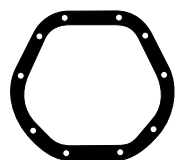

CÓDIGO/Code	1085200
MARCA/Brand	CHEVROLET
DESCRIPCIÓN Descrição Description	DANA 44 802556-2017354 (DIFERENCIAL)

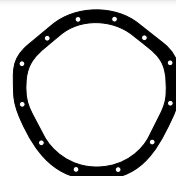

CÓDIGO/Code	1127000
MARCA/Brand	CHEVROLET
DESCRIPCIÓN Descrição Description	SILVERADO CHEYENE (DIFERENCIAL)

JUNTAS PARA DIFERENCIAL Y PALIER

Juntas para Diferencial e Ponta de Eixo / Differential and Bearing Set Gaskets

	CÓDIGO/Code	1085300
	MARCA/Brand	DI TELLA
	DESCRIPCIÓN Descrição Description	12081 (DIFERENCIAL)

	CÓDIGO/Code	1085800
	MARCA/Brand	FIAT
	DESCRIPCIÓN Descrição Description	4615850 TAPA P/619 N1 (DIFERENCIAL)

	CÓDIGO/Code	1085400
	MARCA/Brand	DODGE
	DESCRIPCIÓN Descrição Description	71302502 DODGE 1500 (DIFERENCIAL)

	CÓDIGO/Code	1104000
	MARCA/Brand	FIAT
	DESCRIPCIÓN Descrição Description	SUPERIOR TAPA DIFERENCIAL 780R 1962/69 R55 R60 1955 572255

	CÓDIGO/Code	1085100
	MARCA/Brand	DODGE
	DESCRIPCIÓN Descrição Description	DANA 30 - B4C9 DZ 4036A (DIFERENCIAL)

	CÓDIGO/Code	1149900
	MARCA/Brand	FORD
	DESCRIPCIÓN Descrição Description	350 (PALIER)

CÓDIGO/Code	MARCA/Brand	DESCRIPCIÓN / Descrição / Description
1118900	DODGE/M. BENZ	EATON 182 (JUEGO DIFERENCIAL)

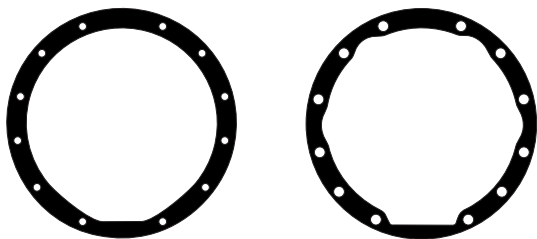

	CÓDIGO/Code	1127100
	MARCA/Brand	FORD
	DESCRIPCIÓN Descrição Description	RANGER (NUCLEO DIFERENCIAL)

	CÓDIGO/Code	1132100
	MARCA/Brand	FORD
	DESCRIPCIÓN Descrição Description	RTPJP1 F100 - 350 HASTA 1981 (PALIER)

	CÓDIGO/Code	1085500
	MARCA/Brand	DODGE/M. BENZ
	DESCRIPCIÓN Descrição Description	EATON 182 51266 - DD1000 (NUCLEO DIFERENCIAL)

	CÓDIGO/Code	1132200
	MARCA/Brand	FORD
	DESCRIPCIÓN Descrição Description	RTPJP2 F100 - 350 DESDE 1981 (PALIER)

	CÓDIGO/Code	1121000
	MARCA/Brand	DODGE/M. BENZ
	DESCRIPCIÓN Descrição Description	EATON 182 TAPA - CG (DIFERENCIAL)

	CÓDIGO/Code	1096300
	MARCA/Brand	JOHN DEERE
	DESCRIPCIÓN Descrição Description	TAPA DIFERENCIAL 1420 R40947

	CÓDIGO/Code	1085700
	MARCA/Brand	FIAT
	DESCRIPCIÓN Descrição Description	4059702 TAPA P/1500 (DIFERENCIAL)

	CÓDIGO/Code	1132300
	MARCA/Brand	JOHN DEERE
	DESCRIPCIÓN Descrição Description	TAPA DIFERENCIAL 2140/2530/2730/3350 T21641

JUNTAS PARA DIFERENCIAL Y PALIER

Juntas para Diferencial e Ponta de Eixo / Differential and Bearing Set Gaskets

ILLINOIS

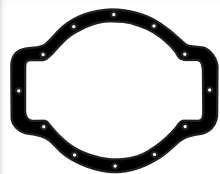

CÓDIGO / Code	1145200
MARCA / Brand	M. BENZ
DESCRIPCIÓN / Descrição / Description	3023510180 OM1315 al 1420 COLECTIVO (DIFERENCIAL)

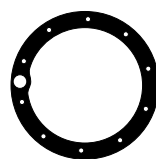

CÓDIGO / Code	1005900
MARCA / Brand	M. BENZ
DESCRIPCIÓN / Descrição / Description	DIFERENCIAL CUBO DE RUEDA 1634 - 1938M ELECTRONICO

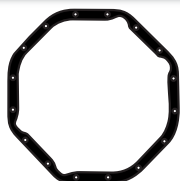

CÓDIGO / Code	1087800
MARCA / Brand	M. BENZ
DESCRIPCIÓN / Descrição / Description	1517 - 3173510280 (DIFERENCIAL)

CÓDIGO / Code	MARCA / Brand	DESCRIPCIÓN / Descrição / Description
1011900	PEUGEOT	504 - 505 HIPOIDAL (JUEGO DIFERENCIAL)

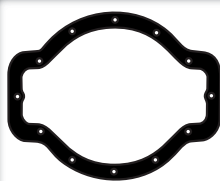
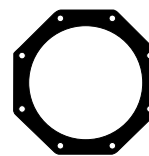
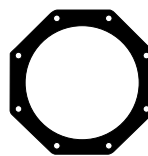

CÓDIGO / Code	1085900
MARCA / Brand	M. BENZ
DESCRIPCIÓN / Descrição / Description	1112-1114 - 3223510080 (DIFERENCIAL)

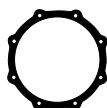

CÓDIGO / Code	1132700
MARCA / Brand	M. BENZ
DESCRIPCIÓN / Descrição / Description	1517 - 3273560180 (PALIER)



CÓDIGO / Code	1120800
MARCA / Brand	PEUGEOT
DESCRIPCIÓN / Descrição / Description	JUNTA PALIER 504 505



CÓDIGO / Code	1087100
MARCA / Brand	M. BENZ
DESCRIPCIÓN / Descrição / Description	993413510580 (PALIER DE CHAPA)

CÓDIGO / Code	MARCA / Brand	DESCRIPCIÓN / Descrição / Description
1086000	PEUGEOT	404 1969 (JUEGO DIFERENCIAL)

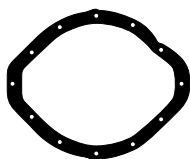
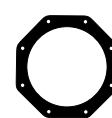
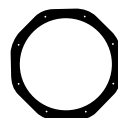

CÓDIGO / Code	1073100
MARCA / Brand	M. BENZ
DESCRIPCIÓN / Descrição / Description	3500 - OM312 (DIFERENCIAL)

CÓDIGO / Code	MARCA / Brand	DESCRIPCIÓN / Descrição / Description
1087200	M. BENZ	1114 - 0140 - OM352 MOTOR ELECTRICO ALTA Y BAJA (JUEGO DIFERENCIAL)



CÓDIGO / Code	1086100
MARCA / Brand	RASTROJERO
DESCRIPCIÓN / Descrição / Description	42 HP (DIFERENCIAL CHICO)

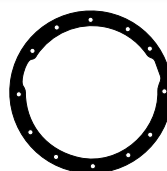

CÓDIGO / Code	1086200
MARCA / Brand	RASTROJERO
DESCRIPCIÓN / Descrição / Description	42 HP (DIFERENCIAL GRANDE)

JUNTAS PARA DIFERENCIAL Y PALIER

Juntas para Diferencial e Ponta de Eixo / Differential and Bearing Set Gaskets

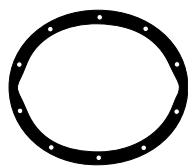

CÓDIGO/Code	1140900
MARCA/Brand	ROCKWELL
DESCRIPCIÓN Descrição Description	CHEVROLET C20/D20 FORD F1000 (DIFERENCIAL CHICO)

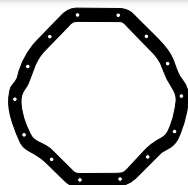

CÓDIGO/Code	1141000
MARCA/Brand	ROCKWELL
DESCRIPCIÓN Descrição Description	FORD F7000/14000 CHEVROLET 14000 (DIFERENCIAL GRANDE)

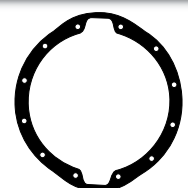

CÓDIGO/Code	1166000
MARCA/Brand	SCANIA
DESCRIPCIÓN Descrição Description	182503 653 -752 SCANIA 111 - MICRO K112 (DIFERENCIAL)

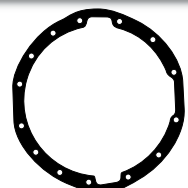

CÓDIGO/Code	1157700
MARCA/Brand	SCANIA
DESCRIPCIÓN Descrição Description	308097 770 SCANIA 112 113 (DIFERENCIAL)

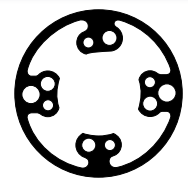

CÓDIGO/Code	1155500
MARCA/Brand	SCANIA
DESCRIPCIÓN Descrição Description	TAPA CREMALLERA DOBLE 112-113-L75-L76-110-111 (527973)

SELLADORES Y
FORMADORES DE JUNTA

ESP

SELADORES
E FORMADORES
DE JUNTA LIQUIDA

PORT

SEALANTS AND
SHAPERS FOR GASKET

ENG



TOP GREY



Sellador Alto Módulo Neutro – Formajunta RTV Alta Temperatura.

Selador Alto Módulo Neutro - Forma junta RTV Alta Temperatura.

High-Modulus Neutral Curing Sealant - RTV Gasket Maker High Temperature.

CÓDIGO Código / Code	PRESENTACIÓN Apresentação / Presentation	COLOR Cor / Color	UNIDAD DE EMPAQUE Unidad de empaquetamento / Packing unit
2199100	▶ Cartucho 315 gr.	Gris	Pack x 10 unidades
	▶ Tubo 315 gr.	Cinza	Pack x 10 unidades
	▶ Cartridge 315 gr.	Gray	Pack x 10 units

CÓDIGO Código / Code	PRESENTACIÓN Apresentação / Presentation	COLOR Cor / Color	UNIDAD DE EMPAQUE Unidad de empaquetamento / Packing unit
2199200	▶ Pomo 95 gr.	Gris	Pack x 10 unidades
	▶ Bismaga 95 gr.	Cinza	Pack x 10 unidades
	▶ Tube 95 gr.	Gray	Pack x 10 units



USOS Y APLICACIONES

USOS E APLICAÇÕES / USES AND APPLICATIONS

ESP Cumple con los requerimientos y especificaciones de desempeño OEM. Se mantiene inalterado en el tiempo, resistente a golpes y vibraciones. Rellena imperfecciones y ralladuras. Para el sellado de elementos de conducción de agua, aceites y gran variedad de líquidos y gases (evitar solventes y combustibles). Alta resistencia al ozono, radiación UV y humedad. No daña sensores de oxígeno. No es corrosivo. Es ignífugo y aislante eléctrico moderado. **Tolerancia de temperaturas:** Desde -70°C hasta 280°C, con intermitentes de hasta 330°C.

Aplicaciones: Los motores con un patrón de espacio estrecho entre tornillos, ejercen alta carga de torque sobre la junta. ILLINOIS Top Grey® esta diseñado para trabajar sobre esas condiciones de exigencia: Sello de los extremos del múltiple y admisión – Turbos – Caja de velocidad – Tapa de válvulas – Cáster - Bomba de agua – Bomba de aceite - Termostato – Tapa distribución, etc.

PORT Cumpre com os requerimentos e especificações de desempenho OEM.

Permanece inalterado no tempo, resistente a golpes e vibrações. Para recheio de imperfeições e riscos. Utilizado na vedação de elementos de condução de água, óleos e em grande variedade de líquidos e gases (evitar solventes e combustíveis). Alta resistência ao ozônio, à radiação UV e à umidade. Não danifica os sensores de oxigênio. Não é corrosivo. É ignífugo e atua como moderado isolante elétrico.

Tolerância de temperaturas: De -70°C a 280°C, com intermitentes até 330°C.

Aplicações: Os motores com padrão de espaço estreito entre parafusos exercem alta carga de torque sobre a junta. O ILLINOIS Top Grey® foi desenhado para trabalhar sobre essas condições de exigência:

Vedação dos extremos do múltiplo e admissão – Turbos – Caixa de Câmbio - Tapa de válvulas – Cáster - Bomba de água – Bomba de óleo - Termostato – Tapa de distribuição, etc.

ENG The seal is resistant to shock and vibration and remains intact over time. Fills imperfections and scratches. Use to seal pipes for water, oil, and a wide range of liquids and gases. Avoid solvents and fuels. High resistance to ozone, UV radiation and humidity. Will not damage oxygen sensors. Non-corrosive. The product is fire-resistant and a moderate electrical insulator.

Temperature range: -70°C to 280°C, up to 330°C intermittent.

Applications: Engines with a tight bolt pattern exert high torque load on the gasket. Illinois Top Grey® is designed to work under these demanding conditions: Intake and exhaust manifolds end seals – turbochargers – gearbox – valve cover – oil pan – water/oil pump – thermostat – timing cover

Mas información y otros usos: www.juntasillinois.com

Mais informações e outros usos: www.juntasillinois.com

More information and other uses: www.juntasillinois.com

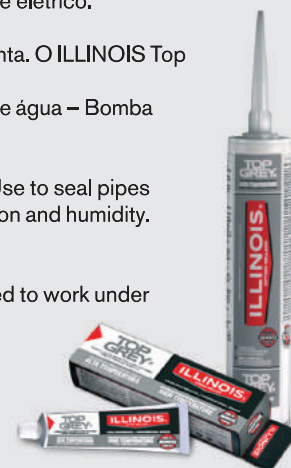

TOP BLACK

Sellador Alto Módulo Neutro – Formajunta RTV Alta Temperatura.

Selador Alto Módulo Neutro - Forma junta RTV Alta Temperatura.

High-Modulus Neutral Curing Sealant - RTV Gasket Maker High Temperature.



CÓDIGO Código / Code	PRESENTACIÓN Apresentação / Presentation	COLOR Cor / Color	UNIDAD DE EMPAQUE Unidad de empaquetamento / Packing unit
2199300	▶ Pomo 70 gr.	Negro	Pack x 10 unidades
	▶ Bisnaga 70 gr.	Preto	Pack x 10 unidades
	▶ Tube 70 gr.	Black	Pack x 10 units



USOS Y APLICACIONES

USOS E APLICAÇÕES / USES AND APPLICATIONS

ESP Cumple con los requerimientos y especificaciones de desempeño OEM. Se mantiene inalterado en el tiempo, resistente a golpes y vibraciones. Rellena imperfecciones y ralladuras. Para el sellado de elementos de conducción de agua, aceites y gran variedad de líquidos y gases (evitar solventes y combustibles). Alta resistencia al ozono, radiación UV y humedad. No daña sensores de oxígeno. No es corrosivo. Es ignífugo y aislante eléctrico moderado. **Tolerancia de temperaturas:** Desde -70°C hasta 280°C, con intermitentes de hasta 330°C.

Aplicaciones: Los motores con un patrón de espacio estrecho entre tornillos, ejercen alta carga de torque sobre la junta. ILLINOIS Top Black® esta diseñado para trabajar sobre esas condiciones de exigencia: Sello de los extremos del múltiple y admisión – Turbos – Caja de velocidad – Tapa de válvulas – Cáster - Bomba de agua – Bomba de aceite - Termostato – Tapa distribución, etc.

PORT Cumpre com os requerimentos e especificações de desempenho OEM.

Permanece inalterado no tempo, resistente a golpes e vibrações. Para recheio de imperfeições e riscos. Utilizado na vedação de elementos de condução de água, óleos e em grande variedade de líquidos e gases (evitar solventes e combustíveis). Alta resistência ao ozônio, à radiação UV e à umidade. Não danifica os sensores de oxigênio. Não é corrosivo. É ignífugo e atua como moderado isolante elétrico.

Tolerância de temperaturas: De -70°C a 280°C, com intermitentes até 330°C.

Aplicações: Os motores com padrão de espaço estreito entre parafusos exercem alta carga de torque sobre a junta. O ILLINOIS Top Black® foi desenhado para trabalhar sobre essas condições de exigência:

Vedação dos extremos do múltiplo e admissão – Turbos – Caixa de Câmbio - Tapa de válvulas – Cáster - Bomba de água – Bomba de óleo - Termostato – Tapa de distribuição, etc.

ENG The seal is resistant to shock and vibration and remains intact over time. Fills imperfections and scratches. Use to seal pipes for water, oil, and a wide range of liquids and gases. Avoid solvents and fuels. High resistance to ozone, UV radiation and humidity. Will not damage oxygen sensors. Non-corrosive. The product is fire-resistant and a moderate electrical insulator.

Temperature range: -70°C to 280°C, up to 330°C intermittent.

Applications: Engines with a tight bolt pattern exert high torque load on the gasket. Illinois Top Black® is designed to work under these demanding conditions: Intake and exhaust manifolds end seals – turbochargers – gearbox – valve cover – oil pan – water/oil pump – thermostat – timing cover

Mas información y otros usos: www.juntasillinois.com

Mais informações e outros usos: www.juntasillinois.com

More information and other uses: www.juntasillinois.com



ALTA TEMPERATURA



Sellador – Formajunta RTV Alta Temperatura Acético.

Selador - Forma junta RTV Alta Temperatura Acético.
Sealant - RTV Gasket Maker High Temperature Acetic.

CÓDIGO Código / Code	PRESENTACIÓN Apresentação / Presentation	COLOR Cor / Color	UNIDAD DE EMPAQUE Unidad de empaquetamento / Packing unit
2099100	▶ Cartucho 280 ml.	Rojo	Pack x 10 unidades
	▶ Tubo 280 ml.	Vermelho	Pack x 10 unidades
	▶ Cartridge 280 ml.	Red	Pack x 10 units

CÓDIGO Código / Code	PRESENTACIÓN Apresentação / Presentation	COLOR Cor / Color	UNIDAD DE EMPAQUE Unidad de empaquetamento / Packing unit
2099200	▶ Pomo 85 ml.	Rojo	Pack x 10 unidades
	▶ Bismaga 85 ml.	Vermelho	Pack x 10 unidades
	▶ Tube 85 ml.	Red	Pack x 10 unidades



USOS Y APLICACIONES

USOS E APLICAÇÕES / USES AND APPLICATIONS

ESP Se mantiene inalterado en el tiempo, resistente a golpes y vibraciones. Rellena imperfecciones y ralladuras. Para el sellado de elementos de conducción de agua, aceites y gran variedad de líquidos y gases (evitar solventes y combustibles). Alta resistencia al ozono, radiación UV y humedad. Es ignífugo y aislante eléctrico moderado.

Tolerancia de temperaturas: desde - 65°C hasta +280°C, con intermitentes de hasta 320°C.

Aplicaciones: Tapa de válvulas - Cáster - Bomba de agua - Bomba de aceite - Tapa distribución, etc.

PORT Permanece inalterado no tempo, resistente a golpes e vibrações. Para recheio de imperfeições e riscos. Utilizado na vedação de elementos de condução de água, óleos e em grande variedade de líquidos e gases (evitar solventes e combustíveis). Alta resistência ao ozônio, à radiação UV e à umidade. É ignífugo e atua como moderado isolante elétrico.

Tolerância de temperaturas: de - 65°C a +280°C, com intermitentes até 320°C.

Aplicações: Tampa de válvulas - Cáster - Bomba de água - Bomba de óleo - Tampa de distribuição, etc.

ENG The seal is resistant to shock and vibration and remains intact over time. Fills imperfections and scratches. Use to seal pipes for water, oil, and a wide range of liquids and gases. Avoid solvents and fuels/combustibles. High resistance to ozone, UV radiation and humidity. The product is fire-resistant and a moderate electrical insulator.

Temperature range: -65°C to 280°C, up to 320°C intermittent.

Applications: Valve Cover - Carter - Water pump - Oil pump - Distributor Cap - etc.



Mas información y otros usos: www.juntasillinois.com

Mais informações e outros usos: www.juntasillinois.com

More information and other uses: www.juntasillinois.com

USO MÚLTIPLE



Adhesivo Uso Múltiple Acético.

Adesivo Uso Múltiple Acético.
Adhesive Multiple Uses Acetic.

CÓDIGO Código / Code	PRESENTACIÓN Apresentação / Presentation	COLOR Cor / Color	UNIDAD DE EMPAQUE Unidad de empaquetamento / Packing unit
2099300	▶ Cartucho 280 ml.	Transparente	Pack x 10 unidades
	▶ Tubo 280 ml.	Transparente	Pack x 10 unidades
	▶ Cartridge 280 ml.	Clear	Pack x 10 units



USOS Y APLICACIONES

USOS E APLICAÇÕES / USES AND APPLICATIONS

ESP Se mantiene inalterado en el tiempo, resistente a golpes y vibraciones. Rellena imperfecciones y ralladuras. Para el sellado de elementos de conducción de agua, aceites y gran variedad de líquidos y gases (evitar solventes y combustibles). Alta resistencia al ozono, radiación UV y humedad. Es ignífugo y aislante eléctrico moderado.

Tolerancia de temperaturas: desde -30°C hasta +150°C.

Aplicaciones: Adhesivo para juntas de despiece, que no estén expuestas a temperaturas extremas.

PORT Permanece inalterado no tempo, resistente a golpes e vibrações. Para recheio de imperfeições e riscos. Utilizado na vedação de elementos de condução de água, óleos e em grande variedade de líquidos e gases (evitar solventes e combustíveis). Alta resistência ao ozônio, à radiação UV e à umidade. É ignífugo e atua como moderado isolante elétrico.

Tolerância de temperaturas: de -30°C a +150°C.

Aplicações: Adesivo para juntas de desmonte não expostas a temperaturas extremas.

ENG The seal is resistant to shock and vibration and remains intact over time. Fills imperfections and scratches. Use to seal pipes for water, oil, and a wide range of liquids and gases. Avoid solvents and fuels. High resistance to ozone, UV radiation and humidity. The product is fire-resistant and a moderate electrical insulator.

Temperature range: -30°C to 150°C.

Applications: Adhesive sealant for quartering gaskets, which are not exposed to extreme temperature conditions.



Mas información y otros usos: www.juntasillinois.com

Mais informações e outros usos: www.juntasillinois.com

More information and other uses: www.juntasillinois.com

ESCAPLUS



Sellador para Sistemas de escape Alta Temperatura.

Selador para Sistemas de escapamento Alta Temperatura.
Sealant for Exhaust Systems High Temperature

CÓDIGO Código / Code	PRESENTACIÓN Apresentação / Presentation	COLOR Cor / Color	UNIDAD DE EMPAQUE Unidad de empaquetamento / Packing unit
2099800	▶ Pote 200 gr.	Beige	x unidad
	▶ Pote 200 gr.	Bege	x unidade
	▶ Pot 200 gr.	Beige	x unit

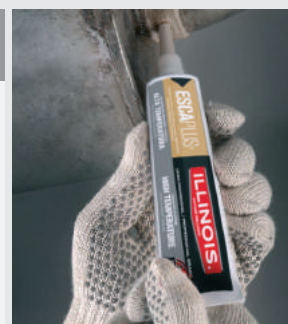

USOS Y APLICACIONES

USOS E APLICAÇÕES / USES AND APPLICATIONS

ESP Se mantiene inalterado en el tiempo. Rellena imperfecciones y orificios. Para el sellado de elementos de conducción gases, aceites y gran variedad de líquidos (evitar solventes y combustibles). Alta resistencia al ozono y radiación UV. No es corrosivo.

Tolerancia de temperaturas: Desde -5°C hasta 900°C, con intermitentes de hasta 950°C.

Aplicaciones: Sellador de empalmes y grietas para sistemas de escape y piezas metálicas expuestas a temperaturas extremas. Compuesto especial resistente a los gases corrosivos emitidos por el escape.

PORT Permanece inalterado no tempo. Para recheio de imperfeições e buracos. Utilizado na vedação de elementos de condução de gases, óleos e em grande variedade de líquidos (evitar solventes e combustíveis). Alta resistência ao ozônio e à radiação UV. Não é corrosivo.

Tolerância de temperaturas: De -5°C a 900°C, com intermitentes até 950°C.

Aplicações: Vedação de conexões e fendas para sistemas de escapamento e peças metálicas expostas a temperaturas extremas. Composto especial resistente a gases corrosivos emitidos pelo escapamento.

ENG The seal remains intact over time. Fills imperfections and holes. Use to seal pipes for gases, oil and a wide range of liquids. Avoid solvents and fuels. High resistance to ozone and UV radiation. Non-corrosive.

Temperature range: from 5°C to 900°C, up to 950°C intermittent.

Applications: Sealant for splices and cracks to the exhaust system and metal parts exposed to high temperatures. It contains a special component that is resistant to the effect of gases and the corrosive heat of the exhaust system.



Más información y otros usos: www.juntasillinois.com

Mais informações e outros usos: www.juntasillinois.com

More information and other uses: www.juntasillinois.com

ILLINOIS[®]

TORNILLOS
PARA CULATA DE CILINDROS

ESP

PARAFUSOS
DE CABEÇOTE

PORT

CYLINDER
HEAD BOLTS

ENG

BU

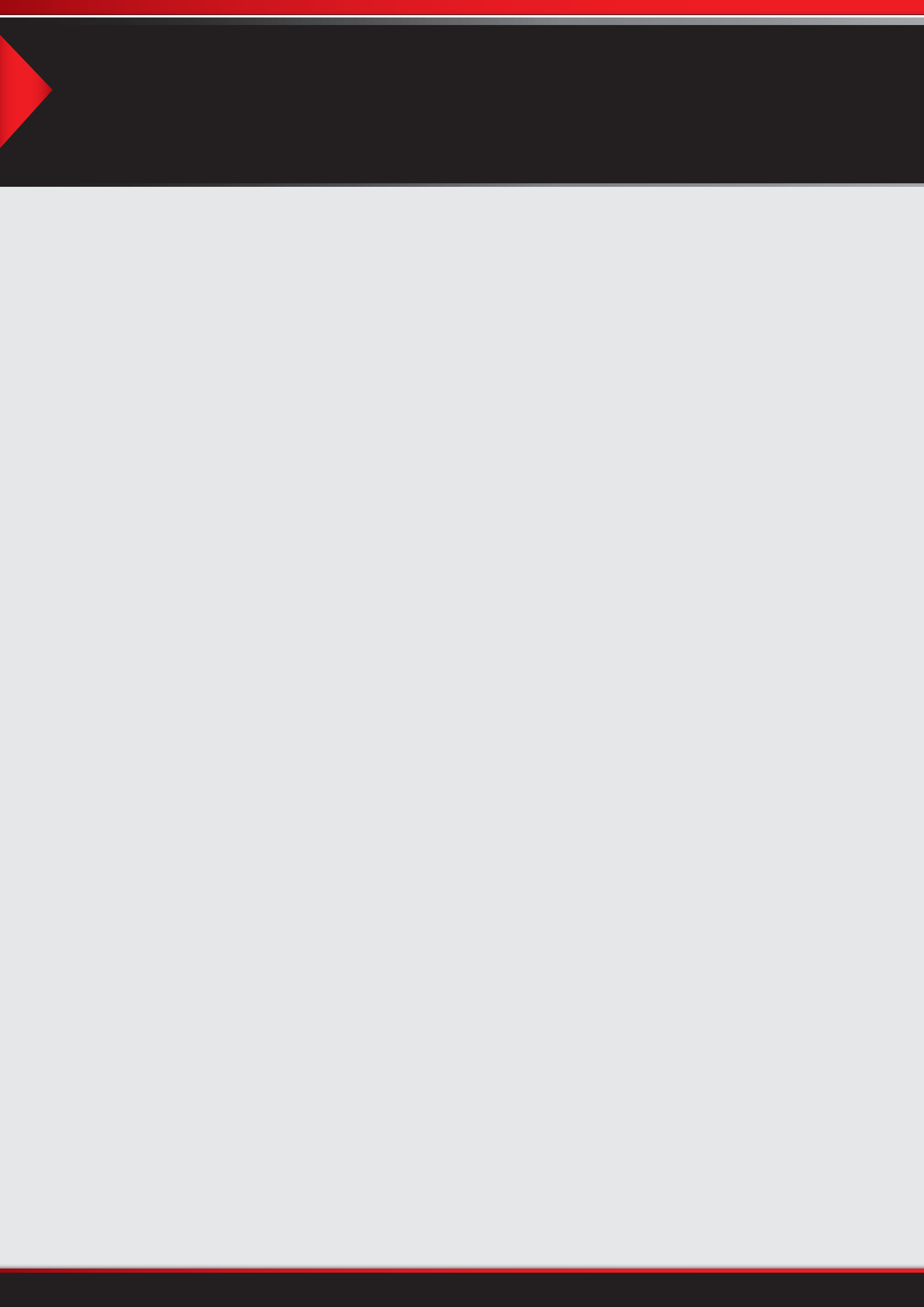

TORNILLOS PARA CULATA DE CILINDROS (BU) Parafusos de Cabeçote / Cylinder Head Bolts

Ordenado por cm³ / Ordenados pelo cm³
Arranged by cm³

Unidad de empaque / Unidade de Embalagem / Packaging Unit: X Juego x Jogo / x Set

CODIGO	MARCA	DESCRIPCION	COMB.	CANT	MEDIDAS	CABEZA	Nº ORIGINAL	JUEGOS EN LOS QUE APLICA		
								TC	JR / SJ	JD
BU-068	AUDI	100D/TD/TDI AVANT 5000D/TD A6TDI 1985/.. - 2,0/2,4/2,5 - CN/NC/AA5/3D AT/ABP/AEL/1T	Diesel	12	M12 x 1,75 x 115	Dodecagonal interior con arandela	068103384A			
BU-069	AUDI	COUPE 80 100 200 500 4000 5000 5 CILINDROS - 2,2 - JY/KG/KH/KJ/WJ/WK/WWS		12 12	M11 x 1,5 x 98 Arandelas A11,5 x 21,5 x 4H	Dodecagonal interior con cuello y arandela	049103384B 049103385			
BU-052	CHEVROLET DAEWOO FIAT SUZUKI	CORSA CELTA EFI MPFI CHEVY GL COMBO ASTRA TIGRA KADETT MERIVA RACER LANOS NEXIA CIELO ESPERO KALOS LEMANS STYLO PALIO/FLEX STILO STRADA IDEA G2/G3 FUN - 1,0/1,2/1,3/1,4/1,5/1,6/1,8 - C10NE MPFI 8V (SOHC/VHC) OHC C12NZ 12NZ EFI MPFI B10Z C14SE/X14NZ/LQ5 C14NZ/NV OHC G15MF E16SE/NE/NZ C16LZ/NZ/SV C16 SE/X16 SZR 8V POWERTRAIN OHC 171/190 MPFI 8V F14S3 G15MF OHC171190 17241C1 C10NE MPFI 8V (SOHC)		10	M10 x 1,25 x 140	Torx con flange	9330481 90469101 711490	TC-106-15	JR-319	JD-168
								TC-125	JR-333-15	JD-319
								TC-185	JR-373	JD-333-15
								TC-597	JR-374-15	JD-374-15
								TC-705	JR-466	JD-466
									JR-473-15	JD-473-15
									JR-478-15	JD-478-15
									JR-521-15	JD-521-15
									JR-540	JD-540
									SJ-319	
									SJ-333	
									SJ-374	
									SJ-466	
									SJ-473	
									SJ-478	
									SJ-521	
									SJ-540	
BU-051	CHEVROLET	CORSA COMBO CELTA TIGRA CHEVY ASTRA CAVALIER ASCONA CHEVY GL MPFI VECTRA KADETT - 1,0/1,2/1,4/1,5/1,6 - OHC C12NZ 12NZ EFI MPFI B10Z EFI C14NZ/NV OHC C14SE/X14NZ/LQ5 G15MF E16SE/NE/NZ OHC C16LZ/NZ/SV C16 SE/X16 SZR 8V		10	M10 x 1,25 x 140	Hexagonal con cuello especial	90005PM3004	TC-125	JR-333-15	JD-168
								TC-597	JR-373	JD-333-15
								TC-705	JR-374-15	JD-374-15
									JR-478-15	JD-478-15
									JR-540	JD-540
									SJ-333	
									SJ-374	
									SJ-478	
									SJ-540	
BU-176	CHEVROLET	CORSA COMBO CELTA TIGRA CHEVY ASTRA CAVALIER ASCONA CHEVY GL MPFI VECTRA KADETT - 1,0/1,2/1,4/1,5/1,6 - OHC C12NZ 12NZ EFI MPFI B10Z EFI C14NZ/NV OHC C14SE/X14NZ/LQ5 G15MF E16SE/NE/NZ OHC C16LZ/NZ/SV C16 SE/X16 SZR 8V		10	M10 x 1,25 x 136	Torx con ala ancha		TC-125	JR-333-15	JD-168
								TC-597	JR-373	JD-333-15
								TC-705	JR-374-15	JD-374-15
									JR-478-15	JD-478-15
									JR-540	JD-540
									SJ-333	
									SJ-374	
									SJ-478	
									SJ-540	
BU-002	CHEVROLET FIAT	CORSA 1998/... CORSA II MERIVA TIGRA ASTRA VECTRA PALIO FASE II - 1,0/1,6/1,8 - MPFI (DOHC) C16XE/XEL/Y16XE L79/ALX DOHC 16V		10	M10 x 1,25 x 153	Torx con flange y arandela	90412701 0607960	TC-180-15	JR-123-15	JD-131-15
								TC-552	JR-522-15	JD-522-15
								TC-896-15	JR-553	JD-553
									SJ-125	
									SJ-522	
									SJ-553	
BU-238	CHEVROLET	CORSA CLASSIC CELTA - 1.4 - G3 (CON BULÓN CABEZA ESPECIAL PARA TAPA VALVULA)		8 2	M10 x 1,25 x 136 M10 x 1,25 x 136	Torx con ala ancha Hexagonal especial con ala		TC-597	JR-597	JD-597
									SJ-597	

TORNILLOS PARA CULATA DE CILINDROS (BU) Parafusos de Cabeçote / Cylinder Head Bolts

 Ordenado por cm³ / Ordenados pelo cm³
 Arranged by cm³

Unidad de empaque / Unidade de Embalagem / Packaging Unit: X Juego x Jogo / x Set

CODIGO	MARCA	DESCRIPCION	COMB.	CANT	MEDIDAS	CABEZA	N° ORIGINAL	JUEGOS EN LOS QUE APLICA			
								TC	JR / SJ	JD	
BU-171	CHEVROLET DAEWOO	AVEO NUBIRA OPTRA LACETTI KALOS NUBIRA - 1,4/1,6 - F14D3/F16D3 16V		10	M10 x 1,25 x 166	Hexagonal con ala		607242	TC-795	JR-551	JD-551
								5094005027	TC-796	JR-552	JD-552
								94501031		SJ-551	
BU-001	CHEVROLET	CORSA COMBO ASTRA - 1,7 - 4EE1 Y17 DIT/DTL (DOHC) 16V TD	Diesel	10	M12 x 1,5 x 100	Hexagonal interior con arandela		0607939	TC-512	SJ-274	JD-274-ST
								94320618	TC-905	SJ-502	JD-502-ST
									TC-602		
BU-063	CHEVROLET DAEWOO	MONZA ASTRA KADETT VECTRA REKORD IPANEMA LUV S10 CAVALIER ESPERO ARANOS PRINCE LEMANS - 1,8/2,0/2,2 - C18NE/SE C20NE/LE/NF/SEH/SER OHC 20NEJ		10	M11 x 1,25 x 137	Torx interior con ala		607685	TC-612-15	JR-380-15	JD-380-15
								90444861	TC-614-15	JR-480-15	JD-480-15
								93294943	TC-712	JR-481-15	JD-481-15
										JR-520-15	JD-520-15
										SJ-380	
										SJ-480	
										SJ-481	
		SJ-520									
BU-064	CHEVROLET DAEWOO	VECTRA ASTRA ZAFIRA SINTRA OPTRA LEGANZA NUBIRA I/II MAGNUS - 2,0/2,2 - X20SED/XEV X22XE 8V MPFI (SOHC) / L34 16V (DOHC)		10	M11 x 1,25 x 105	Torx interior con arandela		90466480	TC-589-15	JR-530-15	JD-530-15
								607256	TC-712	JR-537-15	JD-537-15
								802970		JR-538-15	JD-538-15
										JR-554-15	
										SJ-530	
										SJ-537	
										SJ-538	
		SJ-554									
BU-504	CHEVROLET ISUZU	PICK UP LUV TROOPER AMIGO - 2,3 - 4ZD1		10	M12 x 1,5 x 102	Hexagonal interior con arandela			TC-116-15	JR-122-15	JD-222-15
									SJ-122		
BU-506	CHEVROLET ISUZU	ELF250 NKR NHR54 TROOPER LUV - 2,5/2,7/2,8 - 4JA1/4JB1/T	Diesel	18	M11 x 1,5 x 122	Hexagonal			TC-687	JR-723-11	
BU-073	CHEVROLET VAUXHALL	VECTRA CALIBRA 1989/.. OMEGA 1994/99 SINTRA 1996/99 - 2,5/5,6/3,0/3,2 - C25XE/X25XE T26 X30XE Y32SE Z32SE DOHC 24V		8	M11 x 1,25 x 105	Torx interior con arandela		90466480 607256			
BU-065	CHEVROLET	SUPER SPECIAL RALLY SPORT 400/63 SS 62/681 400 64/72 SILVERADO CHEYENNE P-UP CHEVY 7B 68/78 MALIBU SILVERADO C20 CUSTOM P-UP C10 89/... - 3,2/3,8/4,0/4,1 - 194 230 250		14	1/2-13 x 3' `5/8 (92mm)	Hexagonal			TC-156-15	JR-117-15	JD-103-15
									TC-524-15	JR-232-15	
										JR-334-15	
BU-168	DAEWOO	DAMA TICO LABO MATIZ - 0,8 - F8CV		8	M10 x 1,25 x 97	Hexagonal con ala			TC-118-15	JR-770-15	JD-770-15
										SJ-770	
BU-134	DODGE	D1500/1800 PAKAN GT90 GT100 VW: 1500 1800 - 1,5/1,8 - HILLMAN		10 10	7/16 x 93 Arandelas A11,5 x 21,5 x 4H	Hexagonal			TC-192	JR-130-15	JD-106-15
BU-074	ESTANCIERA	CONTINENTAL BAQUEANO BERGANTIN 57/64 6 CIL. - 3,7 - L226		33	3/8"-16 x 70 (2"3/4)	Hexagonal			TC-199	JR-135-05	
BU-075	FIAT	600 ERS/DER 750 770 800 850 SEAT: 133 - 0,8 - 100D/170R		1	M8 x 1,25 x 60	Hexagonal			TC-208	JR-137-15	JD-104-15
				8	M8 x 1,25 x 90						
				1	M8 x 1,25 x 95						

TORNILLOS PARA CULATA DE CILINDROS (BU) Parafusos de Cabeçote / Cylinder Head Bolts

Ordenado por cm³ / Ordenados pelo cm³
Arranged by cm³

Unidad de empaque / Unidade de Embalagem / Packaging Unit: X Juego x Jogo / x Set

CODIGO	MARCA	DESCRIPCION	COMB.	CANT	MEDIDAS	CABEZA	Nº ORIGINAL	JUEGOS EN LOS QUE APLICA		
								TC	JR / SJ	JD
BU-009	FIAT	UNO SMART CINQUECENTO PALIO SIENA STRADA - 1,0/1,1/1,3/1,4 - 156A2000/2246 146C3000 FIRE 8V MPI		10	M9 x 1,25 x 96	Hexagonal con flange	769619710 55187738	TC-448	JR-352-15	JD-352-15
								TC-725	JR-492	JD-492
									JR-496	JD-496
									SJ-352	
									SJ-492	
BU-053	FIAT	PALIO SIENA STILO- 1,0/1,3 - FIRE 16V		10	M9 x 1,25 x 87	Spline interior con ala	7795992	TC-726	JR-493	JD-493
									SJ-493	
BU-004	FIAT	UNO MILLE PALIO/MPI SIENA 147 PREMIO TREND - 1,0/1,3/1,5 - 146B 127AB/2C ED/EDX MPI/EL MPI	<i>Diesel</i>	5	M12 x 1,25 x 140	Hexagonal con ala	7581743 16233830 7635689	TC-504-15	JR-353-15	JD-138-ST
				4	M8 x 1,25 x 80			TC-536	JR-369-15	JD-353-15
				5	M10 x 1,25 x 96 + 20			TC-608-20	JR-383-15	JD-369-15
									SJ-235	JD-383-15
									SJ-353	
BU-529	FIAT	128 147 SPAZIO EUROPA 1100 71/83 FIORINO UNO 70 REGATTA DUNA - 1,1/1,3/1,5 - 128A.038 128A1 138B2 831B		5	M12 x 1,25 x 104	Hexagonal	46430687 46430688	TC-209	JR-138-15	JD-108-15
				5	M12 x 1,25 x 80 (+24)			TC-405	JR-230-15	JD-109-15
BU-006	FIAT	SPAZIO DUNA UNO VIVACE PALIO SIENA FIORINO TEMPRA EUROPA REGATTA 85 RITMO PREMIO UNO 75CV I.E - 1,4/1,5/1,6 - 149C1.000 138/C3.048 MOTOR TIPO 146C1/5/6 159A2/A3 160A1/A2835A		5	M10 x 1,25 x 98	Hexagonal con flange	46430688 46430687	TC-454	JR-294-15	JD-121-15
				5	M10 x 1,25 x 84			TC-534	JR-340-15	JD-135-15
								TC-535	JR-341-15	JD-136-15
								TC-537-15	JR-384-15	JD-137-15
									SJ-121	
BU-008	FIAT	PALIO SIENA BRAVO MAREA STRADA - 1,6 - TORQUE 16V 182A4 182A6 185A3 186A4 178B		10	M10 x 1,25 x 101	Spline interior con flange	7758731	TC-618	JR-382-15	JD-382-15
									SJ-382	
BU-243	FIAT	PALIO SIENA PUNTO STRADA PALIO WEEKEND IDEA/ADVENTURE 16V - 1.6/1.8 - E-TORQ		10	M10 x 1,5 x 149	Hexagonal con flange y arandela		TC-934	JR-734	JD-734
								TC-935	JR-735	JD-735
									SJ-734	
							SJ-735			
BU-005	FIAT	DUNA FIORINO UNO TIPO PALIO TEMPRA DUCATO SIENA - 1,7/1,9 - 149B 176A 160D DIESEL	<i>Diesel</i>	10	M12 x 1,25 x 134	Spline interior con cuello	7653650	TC-615	SJ-246	JD-152-ST
BU-007	FIAT	MAREA BRAVO 1996/99 BRAVA PUNTO MARENGO TD - 1,9 - 182 A8000/A7000	<i>Diesel</i>	10	M12 x 1,25 x 218	Spline interior con cuello y punta piloto				
BU-054	FIAT IVECO	DUCATO TD/TDS/TDSE 1990/... MAXI IVECO: DAILY TURBO 1990/...(ASPIRADO Y TURBO) - 2,5 - 8140.21 INY. DIRECTA 8140.27/S 8140.47 8140.63D	<i>Diesel</i>	14 8	M12 x 1,25 x 160 M12 x 1,25 x 117	Hexagonal con flange y arandela	4854648 4828150			
BU-003	FIAT IVECO RENAULT	DUCATO TD NUOVO DUCATO DAILY 30.8/35.8 TD TURBO DAILY/INTERCOOLER 3010 3510 4010 4510 4910 3512 4012 4512 4912 5912 MASTER TRAFIC - 2,5/2,8 - 8140.67/S8U 8140.27/S 8140.47/R/S/X230 8140.23/43 8140.67/S8U	<i>Diesel</i>	10 12	M12 x 1,25 x 160 M12 x 1,25 x 117	Hexagonal con flange y arandela	4854648 4828150 760280 760290	TC-823-20	SJ-450	JD-450-ST
								TC-908-20	SJ-501	JD-501-ST
									SJ-550	JD-550-ST
BU-212	FIAT IVECO RENAULT	DUCATO - IVECO DAILY - RENAULT MASTER D/TD 1989/... - 2.5 - 8140.07 8140.27	<i>Diesel</i>	10 12	M12 x 1,25 x 160 M12 x 1,25 x 90	Hexagonal con flange y arandela				
BU-213	FIAT	DUCATO 14/TDS - DUCATO 18 MAX/TDS 4 CIL. - 2.8 - 8140.43 8140.63	<i>Diesel</i>	14 8	M12 x 1,25 x 160 M12 x 1,25 x 90	Hexagonal con flange y arandela		TC-823	SJ-450	JD-450-ST
								TC-898	SJ-526	JD-526-ST

TORNILLOS PARA CULATA DE CILINDROS (BU) Parafusos de Cabeçote / Cylinder Head Bolts

 Ordenado por cm³ / Ordenados pelo cm³
 Arranged by cm³















Unidad de empaque / Unidade de Embalagem / Packaging Unit: X Juego x Jogo / x Set

CODIGO	MARCA	DESCRIPCION	COMB.	CANT	MEDIDAS	CABEZA	N° ORIGINAL	JUEGOS EN LOS QUE APLICA			
								TC	JR / SJ	JD	
BU-013	FORD	FIESTA KA COURIER - 1,0/1,3 - OHV (HCS) OHV/CLX/HCS ENDURA		10	M11 x 1,5 x 121	Hexagonal con flange		6184406 89BM6065DA	TC-596-15	JR-356-15	JD-169-15
									TC-897-15	JR-523-15	JD-523-15
										SJ-267	
BU-022	FORD	FIESTA KA ECOSPORT COURIER - 1,0/1,6 - ZETEC ROCAM ZL 8V		10	M11 x 1,5 x 163	Torx interior con ala y punta piloto		XS6E6065AC	TC-727	JR-388	JD-388
									TC-728	JR-389	JD-389
										SJ-388	
BU-241	FORD	FIESTA KA ECOSPORT COURIER - 1,0/1,6 - ZETEC ROCAM ZL 8V (Con bulones adicionales de cadena de distribucion)		10 2	M11 x 1,5 x 163 M8 x 1,25 x 50	Torx interior con ala y punta piloto		XS6E6065AC	TC-727	JR-388	JD-388
									TC-728	JR-389	JD-389
										SJ-388	
BU-120	FORD CITROEN PEUGEOT	FIESTA ECOSPORT FUSON TDCI C1 C2 C3 XSARA HDI FIESTA ECOSPORT C3 C2 HDI XSARA HDI 206 TDI 307 - 1,4 - DURATORQ DV4TD F6JA/B F6JA/B	Diesel	10	M11 x 1,5 x 147	Torx con flange y punta piloto			TC-885	SJ-541	JD-541-ST
									TC-892	SJ-542	JD-542-ST
BU-012	FORD	FIESTA FOCUS COURIER PUMA - 1,4 - ZETEC SE 16V		10	M10 x 1,5 x 143	Torx interior con ala		1102783 98MM6065A1A	TC-906	JR-535-15	JD-535-15
										SJ-535	
BU-079	FORD	SIERRA L/GL 84/... - 1,6 - OHC		10	M12 x 1,75 x 93	Torx interior			TC-453-15	JR-296-15	JD-296-15
BU-011	FORD	ESCORT FIESTA ORION MONDEO XR2 XR3 - 1,8/2,0 - ZETEC 16V		10	M10 x 1,5 x 102	Torx interior con ala		1024355 928M6065BD	TC-629	JR-390-15	JD-390-15
									TC-630	JR-391-15	JD-391-15
										JR-392-15	JD-392-15
										JR-393-15	JD-393-15
										SJ-390	
										SJ-392	
BU-010	FORD	FIESTA FOCUS COURIER ESCORT MONDEO ORION SIERRA - 1,8 - D18 T/TI TDDI/TDCI DURATORQ DIESEL BHDA/BHDB	Diesel	10	M12 x 1,75 x 137	Torx interior con cuello		6732295 91FF6065AB	TC-637	SJ-265	JD-166-ST
BU-014	FORD	TRANSIT - 2,5 - 4EB/BC/CA/FB/CC/FA/FC/FD 4HC/EA/HB/HC/EB/EC 4CB 4GA/GB/GC/FC/GB/GE/GD	Diesel	18	M12 x 1,75 x 91	Hexagonal con flange		6093964 844F6065AA	TC-201	SJ-273	JD-717-ST
BU-061	FORD	FALCON 4/7 BANCADAS FALCON SP 73/... F100 FAIRLANE 69/... - 2,8/3,1/3,6 - 170/187 4B 187/188/221 7B MAX-ECONO 7B		14	7/16-14 x 83	Hexagonal			TC-250-15	JR-161-15	JD-101-15
										JR-164-15	JD-146-15
										JR-268-15	
										JR-337-15	
BU-081	HONDA	ACCORD III AERO DECK 1985/.. CA4/CA5 SOHC 12V - 1,6/2,0 - A16A1/A20A1 A2/A3/A4		10	M11 x 1,5 x 108	Hexagonal con ala					
BU-217	HONDA	ACCORD V/VI PRELUDE 16V - 2,0/2,2 - F20A2/A3/A4/A8/B3/Z1/Z2 F22A3/A7/A8/B5/B8		10	M12 x 1,50 x 163	Hexagonal con ala y arandela					
BU-216	HONDA	ACCORD VII V6 24V - 3,0 - J30A1 SOHC		8	M12 x 1,50 x 163	Hexagonal con ala y arandela					
BU-083	IVECO	ESPÁRRAGO	Diesel	8	M14-M12 x 2,00 x 170	Espárrago		ED-540440			

TORNILLOS PARA CULATA DE CILINDROS (BU) Parafusos de Cabeçote / Cylinder Head Bolts

Ordenado por cm³ / Ordenados pelo cm³
Arranged by cm³













Unidad de empaque / Unidade de Embalagem / Packaging Unit: X Juego x Jogo / x Set

CODIGO	MARCA	DESCRIPCION	COMB.	CANT	MEDIDAS	CABEZA	N° ORIGINAL	JUEGOS EN LOS QUE APLICA		
								TC	JR / SJ	JD
BU-084	JEEP	IKA 4 CIL. BERGANTIN CONTINENTAL - 2,5 - 4L/151		23	3/8"-16x70 (2"3/4)	Hexagonal 		TC-301	JR-178-05	
BU-520	KIA MAZDA	BESTA BONGO CERES ASIA ROCSTA E2000 626 CAPELLA E/B2200 - 2,0/2,2 - HW R2 RF	Diesel	10	M12 x 1,5 x 113	Dodecagonal con ala 		TC-120-20	JR-345	JD-345
								TC-961-11	SJ-345	
BU-507	KIA	K3500 CAMIÓN TRADE - 3,5 - K3500	Diesel	11 7	M12 x 1,25 x 121 M12 x 1,25 x 150	Dodecagonal con ala y cuello 				
BU-219	M. BENZ	SPRINTER C200/220 E200/220 - 2,2 - OM 611 MB 611.960/61/80/81	Diesel	10	M12 x 1,75 x 102	Torx (E18) 	6119900322	TC-901	SJ-543	JD-543
BU-521	M. BENZ	240D/TD/GD 207 307 407 507 510D L406 407 O309D MB100/120/130140/150/170/180D - 2,4 - MB616	Diesel	4	M12 x 1,75 x 103	Torx interior 		TC-775	JR-303-20	
				8	M12 x 1,75 x 118				SJ-303	
				6	M12 x 1,75 x 143					
BU-220	M.BENZ	SPRINTER CDI C270 C30 CLK270 E270 ML270 G270 - 2,7 - OM612 20V 5 CIL.	Diesel	12	M12 x 1,75 x 102	Torx (E18) 	6119900322			
BU-221	M.BENZ	E320 S320 CDI - 3,0 - OM 613 24V 6 Cil.	Diesel	14	M12 x 1,75 x 102	Torx (E18) 	6119900322			
BU-017	M. BENZ	L608 D/UNIMOG 66/... - 3,8 - OM 314	Diesel	17	M12 x 1,75 x 110	Dodecagonal con ala 	3669900301	TC-442-20	JR-284-20	
									SJ-284	
BU-511	M.W.M.	CHEVROLET S10 TD BLAZER TD - 2,8 - SPRINT 4.07T	Diesel	10	M14 x 2 x 165	Hexagonal 		TC-658	SJ-347	JD-347-ST
BU-021	M.W.M.	FORD VALMET F100 F1000 F4000 - 2,9/3,9/5,9 - D229	Diesel	16	M14 x 2 x 135	Hexagonal con flange 		TC-520-20	JR-329-20	JD-185-20
									JR-378-20	
									SJ-247	
									SJ-378	
BU-512	M.W.M.	FORD F100 CHEVROLET SILVERADO 6 CIL. - 4,2 - SPRINT 6.07TD	Diesel	14	M14 x 2 x 165	Hexagonal 		TC-659-20	SJ-348	JD-348-ST
BU-016	MAXION	CHEVROLET FORD RANGER SPRINTER - 2,5/2,8 - 200 300 TDI POWER STROKE DIESEL	Diesel	4	M10 x 1,5 x 117	Hexagonal con flange 	A0099901301 A0099901101 A0099901201	TC-628	SJ-272	JD-174-ST
				4	M12 x 1,5 x 100					
				10	M12 x 1,5 x 140					
BU-239	MAXION	FORD: RANGER TD BR 2000-2002/... - 2.8 - POWERSTROKE	Diesel	4	M8 x 1,25 x 117	Hexagonal con flange 		TC-793	SJ-272	JD-174-ST
				4	M12 x 1,5 x 100					
				10	M12 x 1,5 x 140					
BU-189	MAXION	FORD RANGER 16V - 3,0 - POWER STROKE TD (SOCH)	Diesel	10	M12 x 1,5 x 140	Torx interior con ala y arandela 	70740783	TC-888	SJ-524	JD-524-ST
									SJ-525	JD-525-ST
BU-510	MITSUBISHI FORD HYUNDAI	L200 CANTER T35 PAJERO MONTERO FORD: BRONCO II TD RANGER 2WD HYUNDAI: H100 H1/LA/ACTROS - 2,4/2,5 - 4D55T/4D56/D4BA-X/D4BH	Diesel	18	M12 x 1,25 x 106	Hexagonal interior 		TC-441	SJ-476	JD-487-ST
									SJ-488	JD-488-ST

TORNILLOS PARA CULATA DE CILINDROS (BU) Parafusos de Cabeçote / Cylinder Head Bolts

 Ordenado por cm³ / Ordenados pelo cm³
 Arranged by cm³













Unidad de empaque / Unidade de Embalagem / Packaging Unit: X Juego x Jogo / x Set

CODIGO	MARCA	DESCRIPCION	COMB.	CANT	MEDIDAS	CABEZA	N° ORIGINAL	JUEGOS EN LOS QUE APLICA		
								TC	JR / SJ	JD
BU-514	NISSAN	BLUEBIRD VANETTE TRADE 80/... 4 CIL. - 2,0 - LD20/E	<i>Diesel</i>	7 4	M12 x 1,75 x 126 M12 x 1,75 x 156	Hexagonal interior 		TC-545-07		
BU-240	NISSAN RENAULT	PRIMASTAR INTERSTAR MASTER TRAFIC - 2,5 - G9U-720/724/730/750/754	<i>Diesel</i>	10	M12 x 1,50 x 131	Torx con ala 		TC-432	SJ-411	JD-411-ST
BU-522	NISSAN FORD	TERRANO D/TD PATHFINDER TRUCK D21 FORD MAVERICK TD - 2,7 - TD27/TD27T	<i>Diesel</i>	18	M12 x 1,5 x 113	Hexagonal 		TC-282	SJ-527	
BU-515	NISSAN	LAUREL CEDRIC MAXIMA SKYLINE BLUEBIRD 6 CIL. - 2,8 - LD28	<i>Diesel</i>	9 5	M12 x 1,75 x 126 M12 x 1,75 x 156	Hexagonal interior con cuello 		TC-546-06		
BU-505	PERKINS FIAT FORD MASSEY FERGUSON	TRACTOR 350 VIÑADERO MF 150/155/250/165 69/90 265 MF50 MF50X/55X/135/200/235/250 DODGE: POLARA D100/200 FORD:F100 P-UP JEEP F100 TRACTOR 8 BR INY. INDIRECTA - 2,4/2,5/3,3 - 3-152 4.203	<i>Diesel</i>	9	7/16" x 20 UNF x 100	Hexagonal 	32181458	TC-361-01 TC-425 TC-607-20	JR-190 JR-247-01 JR-269-01 JR-304-01 JR-307-01 JR-328	JD-113 JD-124-01 JD-161-20 JD-503
BU-099	PERKINS	3-152 - 2,5	<i>Diesel</i>	12	7/16NF-3/8NF x 152.4	Espárrago 	32754415			
BU-100	PERKINS	3-152 - 2,5	<i>Diesel</i>	6	7/16NF x 109,6 A16B19	Espárrago 	32524133			
BU-101	PERKINS	3-152 - 2,5	<i>Diesel</i>	1	7/16NF x 117,4 A19B24	Espárrago 	32524134			
BU-115	PERKINS	3-152 - 2,5	<i>Diesel</i>	20	3/8NF x 36,5 A12B16	Espárrago 	825258			
BU-117	PERKINS	3-152 - 2,5	<i>Diesel</i>	15	5/16NF x 38,1 A13B18	Espárrago 	826232			
BU-103	PERKINS	3-152AD - 2,5	<i>Diesel</i>	1	7/16NF x 104 A15B19	Espárrago 	32524148			
BU-116	PERKINS	4-203 - 3,4	<i>Diesel</i>	13	3/8NF x 41 A13B19	Espárrago 	1544			
BU-110	PERKINS	4-212 / 4-236 / 4-248 - 3,9/4,0	<i>Diesel</i>	1	1/2NF x 121 A19B20	Espárrago 	32526311			

TORNILLOS PARA CULATA DE CILINDROS (BU) Parafusos de Cabeçote / Cylinder Head Bolts

Ordenado por cm³ / Ordenados pelo cm³
Arranged by cm³

Unidad de empaque / Unidade de Embalagem / Packaging Unit: X Juego x Jogo / x Set

CODIGO	MARCA	DESCRIPCION	COMB.	CANT	MEDIDAS	CABEZA	Nº ORIGINAL	JUEGOS EN LOS QUE APLICA		
								TC	JR / SJ	JD
BU-111	PERKINS	ESPÁRRAGO	<i>Diesel</i>	1	1/2NF x 146 A19B68	Espárrago 	32526319			
BU-104	PERKINS	ESPÁRRAGO	<i>Diesel</i>	6	7/16BSF x 117,5	Espárrago 	32577309			
BU-105	PERKINS	ESPÁRRAGO	<i>Diesel</i>	12	7/16BSF-3/8BSW x 152	Espárrago 	32761118			
BU-106	PERKINS	ESPÁRRAGO	<i>Diesel</i>	1	1/2NF x 101 A16B20	Espárrago 	1532			
BU-108	PERKINS	ESPÁRRAGO	<i>Diesel</i>	1	1/2NF x 136,5 A19B26	Espárrago 	32526323			
BU-109	PERKINS	ESPÁRRAGO	<i>Diesel</i>	1	1/2NF x 127 A19B26	Espárrago 	32526324			
BU-113	PERKINS	ESPÁRRAGO	<i>Diesel</i>	1	3/8-5/16NF x 97	Espárrago 	5825241			
BU-114	PERKINS	ESPÁRRAGO	<i>Diesel</i>	1	3/8-5/16BSF/BSW x 98	Espárrago 	32757416			
BU-123	PEUGEOT RENAULT	206 16V 2000/...M725 TWINGO CLIO/II SANDERO KANGOO - 1,0/1,1 - D4D/D4F 702/712/720		10	M9 x 1,25 x 123	Torx con ala 		TC-886	JR-426	JD-426
									JR-528	JD-528
									SJ-426	
									SJ-528	
BU-033	PEUGEOT CITROEN	C2 C3 BERLINGO 106 205 306 307 PARTNER XSARA SAXO ZX - 1,1/1,3/1,4/1,6 - TU1/2/3/4 TU3JP KfV/KfW/K6D TU5JP/J2		10	M10 x 1,5 x 176	Torx con ala y cuello 	9624951480 020483	TC-648	JR-379-15	JD-175-15
								TC-649-15	JR-509	JD-509
								TC-787	JR-515	JD-515
									SJ-509	
									SJ-279	
									SJ-515	
BU-200	PEUGEOT CITROEN	106 1994/... AX15 1994/97 SAXO 1996/... - 1,5 - TUD5 (VJY/VJZ)	<i>Diesel</i>	10	M11 x 1,5 x 184	Torx con ala y arandela 	020485	TC-438-20	JR-489	JD-489
									SJ-489	
BU-032	PEUGEOT CITROEN	504 505/GAMMA 505 CON AIRE ACOND. 604 305 306 309 405 SRI 406 806 PARTNER BERLINGO XSARA XANTIA - 1,6/1,8/1,9/2,0 - XN1 XN2 XNA GR/SR XN1/XN2 XN6 XU5CP/M XU7JP/ZJB 8V XU92C/5/M/J1/J2 XU7JB		10	M11 x 1,5 x 175	Torx interior 	9600597780 020457	TC-428	JR-276-15	JD-143-15
								TC-616	JR-317-15	JD-176
									JR-370	JD-252-15
									JR-385	JD-385
									JR-387	JD-387
									SJ-252	
									SJ-253	
									SJ-278	
									SJ-385	
									SJ-387	
BU-223	PEUGEOT CITROEN	206 307 PARTNER C2 C3 BERLINGO XSARA - 1,6 - TU5JP4 (NFU/N6A) 16V		10	M10 x 1,50 x 122	Torx (E14) con arandela 	0204C4	TC-785	JR-511	JD-511
									SJ-511	

TORNILLOS PARA CULATA DE CILINDROS (BU) Parafusos de Cabeçote / Cylinder Head Bolts

Ordenado por cm³ / Ordenados pelo cm³
Arranged by cm³

Unidad de empaque / Unidade de Embalagem / Packaging Unit: X Juego x Jogo / x Set

CODIGO	MARCA	DESCRIPCION	COMB.	CANT	MEDIDAS	CABEZA	N° ORIGINAL	JUEGOS EN LOS QUE APLICA			
								TC	JR / SJ	JD	
BU-031	PEUGEOT CITROEN	BERLINGO XSARA XANTIA 305 306 309 405 SRI 406 806 PARTNER - 1,6/1,8/1,9 - XU5CP/M XU7JP/Z/JB 8V XU92C/5/M/J1/J2		10	M11 x 1,5 x 168	Torx interior con ala		020489	TC-616	JR-370	JD-176
										JR-385	JD-385
										JR-387	JD-387
										SJ-278	
										SJ-385	
										SJ-387	
BU-026	PEUGEOT	404 504 505/GAMMA 505 CON AIRE ACOND. 604 - 1,6/1,8/2,0 - XC7 XC6A XC7 XM7/T/P XN1 XN2 XNA GR/SR XN1/XN2 XN6		10	M12 x 1,5 x 148	Hexagonal		7700855231	TC-358	JR-199-15	JD-111-15
									TC-409	JR-233-15	JD-120-15
									TC-428	JR-276-15	JD-143-15
										JR-317-15	JD-252-15
										SJ-252	
										SJ-253	
BU-057	PEUGEOT CITROEN FIAT	504 505 J5 J7 1973/93 (0199416) CITROEN C25 1981/... FIAT DUCATO 1981/... - 1,8 - 280/A14-169B XC7 - XM7/T/P		10	M11 x 1,5 x 109	Hexagonal			TC-409	JR-233-15	JD-120-15
BU-034	PEUGEOT CITROEN	306 406 XSARA XANTIA - 1,8/2,0 - XU7JP4 XU10 J4R/RV 16V		10	M11 x 1,5 x 159	Torx con ala y arandela		020480	TC-589	JR-394-15	JD-394-15
										SJ-394	
BU-055	PEUGEOT RASTROJERO	404 T4B J7 TB INDENOR 71/80 RASTROJERO 1972/... - 1,8/1,9 - TMD85/X85 XD/XDP 4.88	Diesel	7	M11 x 1,5 x 118	Hexagonal			TC-359	JR-200-20	JD-119-20
				7	M11 x 1,5 x 109						
				8	M11 x 1,5 x 92					SJ-229	
BU-030	PEUGEOT	205 305/6/9 405/6 806 EXPRESS T/TD EXPERT PARTNER BOXER TD CITROEN - 1,8/1,9 - XUD7/TE XUD9/TE	Diesel	10	M12 x 1,5 x 147	Torx interior con ala y punta piloto		020473 758090	TC-253	SJ-259	JD-164-ST
BU-028	PEUGEOT CITROEN	305 GTX 306 309 GT 405/SRI 1987/93 CITROEN: BX19 1984/93 - 1.9 - XU92C/5 XU9M XU9J1/J2		10	M12 x 1,5 x 120	Torx interior con ala			TC-616	JR-370	JD-176
										SJ-278	
BU-029	PEUGEOT	205 206 306 305/6/9 405/6 806 EXPRESS T/TD EXPERT PARTNER BOXER TD CITROEN 206 306 PARTNER EXPORT BERLINGO - 1,8/1,9 - XUD7/TE XUD9/TE DW8 DIESEL DWJ/DWY/WJZ/1WZ	Diesel	10	M12 x 1,5 x 124	Torx con ala y punta piloto		020466	TC-609	SJ-257	JD-164-ST
									TC-643	SJ-258	JD-257-ST
									TC-683	SJ-259	JD-258-ST
									TC-721		
BU-025	PEUGEOT	205 305/6/9 405/6 806 EXPRESS T/TD EXPERT PARTNER BOXER TD CITROEN - 1,8/1,9 - XUD7/TE XUD9/TE	Diesel	10	M12 x 1,5 x 124	Torx interior con ala		9607384680 020465	TC-643	SJ-259	JD-164-ST
									TC-683		
									TC-721		
BU-192	PEUGEOT CITROEN	206 306 406 307 607 806 EXPERT PARTNER XSARA - 2,0 - DW10 HDI DIESEL	Diesel	10	M12 x 1,5 x 126	Torx con flange y punta piloto			TC-242	SJ-397	JD-397-ST
BU-046	PEUGEOT CITROEN	306 406 405 806 XSARA XANTIA EVASION - 2,0 - XU10J4R/RV 16V 132/135HP		10	M12 x 1,5 x 110	Torx interior con ala		020472 9605999480	TC-780-15	JR-505-15	JD-505-15
										SJ-594	
BU-202	PEUGEOT	308 406 407 607 807 3008 16V - 2.2 - EW12J4 (3FZ) EW12J4 (3FY)		10	M11 x 1,5 x 127	Torx con flange y arandela		020495			
BU-119	PEUGEOT CITROEN	406 607 806 807 XSARA EVASION C5 - 2,0 - EW10J4 RFN EW10D RLZ 16V	Diesel Nafta	10	M11 x 1,5 x 145	Torx con ala y arandela			TC-783	JR-512	JD-512
										SJ-512	
BU-023	PEUGEOT	504 505 604 - 2,3/2,5 - INDENOR XD2 XD3	Diesel	7	M11 x 1,5 x 120	Hexagonal con ala		020456/61 020454/60 020455/59	TC-538-20	SJ-215	JD-153-ST
				7	M11 x 1,5 x 108						
				8	M11 x 1,5 x 98						

TORNILLOS PARA CULATA DE CILINDROS (BU) Parafusos de Cabeçote / Cylinder Head Bolts

Ordenado por cm³ / Ordenados pelo cm³
Arranged by cm³

Unidad de empaque / Unidade de Embalagem / Packaging Unit: X Juego x Jogo / x Set

CODIGO	MARCA	DESCRIPCION	COMB.	CANT	MEDIDAS	CABEZA	Nº ORIGINAL	JUEGOS EN LOS QUE APLICA		
								TC	JR / SJ	JD
BU-024	PEUGEOT	504 505 604 - 2,3/2,5 - INDENOR XD2 XD3	Diesel	7 15	M11 x 1,5 x 120 M11 x 1,5 x 108	Hexagonal con ala	020456/61 020454/60	TC-538-20	SJ-215	JD-153-ST
BU-118	PEUGEOT CITROEN	BOXER TDI 1997/... JUMPER RELAY TDI 1997/... - 2,5 - DJ5TED/THX	Diesel	14 8	M12 x 1,5 x 163 M10 x 1,5 x 174	Torx con ala	020487 020488			
BU-121	PEUGEOT	ESPÁRRAGO		4	M10 x 1,50 x 53	Espárrago	9151353080			
BU-122	PEUGEOT	ESPÁRRAGO		8	M10-M7 x 1,50 x 100	Espárrago	7932564588			
BU-059	RENAULT PEUGEOT	CLIO/II TWINGO KANGOO SANDERO 206 - 1,0/1,1/1,2 - D7D/734 D7F D4D/D4F 702/712/720		10	M9 x 1,25 x 103	Torx con flange	7700869008	TC-332-15 TC-886	JR-395-15 JR-528 SJ-395	JD-395-15 JD-528
BU-038	RENAULT FORD VOLKSWAGEN	R12 R4/5/6/9/11/18/19/21 ESTAFETTE RODEO TWINGO CLIO EXPRESS FUEGO TRAFIC SUPER CINCO ALLIANCE ENCORE ESCORT/GL GOL - 1,1/1,2/1,3/1,4/1,6 - 668.01/10-810.88 810.01/02/03/05/19 C3G 847/847.20/81 C1J/C2J C1L C2L C3L CHT/AE		10	M10 x 1,5 x 100	Hexagonal con cuello	706305500	TC-378 TC-414 TC-529 TC-530 TC-719-15	JR-213-15 JR-253-15 JR-298-15 JR-299-15 JR-339-15 JR-342-15 JR-371-15 JR-372-15 JR-490-15	JD-112-15 JD-122-15 JD-144-15 JD-147-15 JD-170-15 JD-299-15 JD-339-15 JD-371-15 JD-490-15
BU-040	RENAULT	MEGANE SCENIC KANGOO CLIO I/II CLIO R19 EXPRESS - 1,2/1,4/1,6 - K7M/K7J E5F/E7F/E6J/E7J ENERGY		5 5	M10 x 1,5 x 98 M10 x 1,5 x 113	Torx con flange	7700738987 7700738986	TC-331 TC-333	JR-212-15 JR-344 SJ-112	JD-212-15 JD-344
BU-242	RENAULT	LOGAN 8V - 1.6 - K7M 8V		5 5	M10 x 1,5 x 94 M10 x 1,5 x 107	Torx con flange		TC-952	JR-749 SJ-749	JD-749
BU-041	RENAULT	MEGANE CLIO SCENIC KANGOO LAGUNA - 1,4/1,6 - K4M/J 16V		10	M10 x 1,5 x 117	Torx con flange		TC-334	JR-343 SJ-343	JD-343
BU-124	RENAULT	CLIO II KANGOO MEGANE DCI - 1,5 - K9K COMMON RAIL	Diesel	10	M11 x 1,5 x 126	Torx (E14) con ala		TC-893	SJ-504	JD-504-ST
BU-173	RENAULT VOLVO	LAGUNA SAFRANE SPACE S40/V40 - 1,7/1,9 - B4184S N7Q 16V B4204S/T		10	M12 x 1,75 x 157	Hexagonal con ala y cuello		TC-412-15	JR-405-15 SJ-405	JD-405-15

TORNILLOS PARA CULATA DE CILINDROS (BU) Parafusos de Cabeçote / Cylinder Head Bolts

 Ordenado por cm³ / Ordenados pelo cm³
 Arranged by cm³

Unidad de empaque / Unidade de Embalagem / Packaging Unit: X Juego x Jogo / x Set

CODIGO	MARCA	DESCRIPCION	COMB.	CANT	MEDIDAS	CABEZA	N° ORIGINAL	JUEGOS EN LOS QUE APLICA			
								TC	JR / SJ	JD	
BU-037	RENAULT	R19 R9 R11 R21 CLIO/RT LAGUNA CHAMADE EXPRESS KANGOO TRAFIC SCENIC MEGANE - 1,7/1,8/1,9/2,0 - F1N F2N F3N F3P F8Q	Diesel Nafta	10	M12 x 1,5 x 109	Torx interior		7700855347	TC-594-15	JR-359-15	JD-163-ST
									TC-633	SJ-260	JD-359-15
									TC-663	SJ-367	
										SJ-368	
BU-036	RENAULT	R19 R9 R11 R21 CLIO/RT LAGUNA CHAMADE EXPRESS KANGOO TRAFIC SCENIC MEGANE - 1,7/1,8/1,9/2,0 - F1N F2N F3N F3P F8Q F3R	Diesel Nafta	10	M12 x 1,5 x 113	Torx con flange		7700104499 758850	TC-595	JR-368-15	JD-163-ST
									TC-633	JR-606-15	JD-368-15
									TC-663	SJ-260	JD-506-15
										SJ-367	
										SJ-368	
BU-203	RENAULT VOLVO	R5 II R9 R11 R19 R21 LAGUNA 1991/98 EXPRESS RAPID CLIO KANGOO TRAFIC SCENIC MEGANE SPACE VOLVO: 440 460 480 1991/97 - 1.6/1.7/1.8/1.9/2.0 - F2N / F3N / F3P / F3R F8Q F8M B20F B18U	Diesel Nafta	10	M12 x 1,5 x 113	Torx con flange y arandela		7700104499 758850	TC-595-15	JR-368-15	JD-163-ST
BU-194	RENAULT	SCENIC LAGUNA CLIO II SPORT SANDERO RS- 1,8/2,0 - F4P F4R DOHC16V		10	M12 x 1,5 x 117	Torx con ala			TC-633	JR-606-15	JD-368-15
										SJ-260	JD-506-15
BU-039	RENAULT	CLIO MEGANE LAGUNA KANGOO R19 EXPRESS SCENIC - 1,9 - F8Q F9Q DIESEL INYECCION DIRECTA	Diesel	10	M12 x 1,5 x 119	Torx con flange		7700865991	TC-663	SJ-384	JD-384-ST
									TC-673	SJ-367	JD-163-ST
BU-048	RENAULT	R18 TX GTX R21 GTA TRAFIC FUEGO - 2,0/2,2 - 829/851		10	M12 x 1,5 x 255	Hexagonal especial		7700661408	TC-443	JR-286-15	JD-140-15
BU-060	RENAULT	R18 R21 TRAFIC MASTER FUEGO - 2,0/2,2 - J5R J6R J7R J7T		10	M12 x 1,5 x 243	Hexagonal especial		7700655891	TC-443	JR-286-15	JD-140-15
										SJ-254	
BU-047	RENAULT	R18 TX GTX R21 GTA TRAFIC FUEGO - 2,0/2,2 - 829/851		10	M12 x 1,5 x 247	Hexagonal		7700655891	TC-443	JR-286-15	JD-140-15
										SJ-254	
BU-035	RENAULT	R18 R21 FUEGO TRAFIC DIESEL - 2,1 - 852/J8S/121	Diesel	2	M12 x 1,5 x 247	Hexagonal Hexagonal Hexagonal con ala		7700730882 7700729429 7700660908	TC-563-20	SJ-249	JD-141-ST
				4	M12 x 1,5 x 148						
				8	M12 x 1,5 x 134						
BU-125	RENAULT	R12		10	M10 x 1,50 x 95	Hexagonal		706305400			
BU-126	RENAULT	R12		10	M10 x 1,50 x 107,5	Hexagonal		706305401			
BU-127	RENAULT	R12 R19 CLT		4	M7 x 1,00 x 102 A14B50	Espárrago		607154202			
BU-128	RENAULT	ESPÁRRAGO VÁLVULA		2	M7 x 1,00 x 95 A10B18	Espárrago		607201602			

TORNILLOS PARA CULATA DE CILINDROS (BU) Parafusos de Cabeçote / Cylinder Head Bolts

Ordenado por cm³ / Ordenados pelo cm³
Arranged by cm³



Unidad de empaque / Unidade de Embalagem / Packaging Unit: X Juego x Jogo / x Set

CODIGO	MARCA	DESCRIPCION	COMB.	CANT	MEDIDAS	CABEZA	N° ORIGINAL	JUEGOS EN LOS QUE APLICA		
								TC	JR / SJ	JD
BU-129	RENAULT	ESPÁRRAGO		7	M8 x 1,25 x 40 A11B18	Espárrago	706329400			
BU-519	TOYOTA	HICE COROLLA TOWNACE CARINA DAIHATSU: DELTA WIDE - 1,8 - C1/T DIESEL	Diesel	8 10	M11 x 1,25 x 123 M11 x 1,25 x 146	Dodecagonal con ala		TC-554		
BU-517	TOYOTA	HILUX ACE HIACE LANDCRUISER DYNA - 2,2/2,4/2,8 - L/2L/2LT/2LTE/3L	Diesel	4 14	M12 x 1,25 x 106 M12 x 1,25 x 126	Dodecagonal con ala	9091002081 9091002080	TC-487 TC-574-20 TC-680	JR-542 JR-659-11	
BU-207	TOYOTA	COROLLA AURIS AVENSIS CELICA RAV 4 SPIDER FIELDER MR2 16V - 1.4/1.6/1.8 - 4ZZ-FE 3ZZ-FE 1ZZ-FE		10	M10 x 1,5 x 147	Dodecagonal interior con flange		TC-433	JR-459 SJ-459	JD-459
BU-170	TOYOTA	HILUX D-4D 4WD SW4 HIACE FORTUNER DYNA 150 - 2.5/3.0 - 2KD-FTV 1KD-FTVDOHC 16V	Diesel	10 8	M12 x 1,25 x 110 M12 x 1,25 x 167	Dodecagonal con flange		TC-926 TC-931	SJ-341	JD-341
BU-518	TOYOTA	HILUX TD 4 RUNNER LANDCRUISER - 3,0 - 1 KZ T/TE125 HP	Diesel	18	M12 x 1,25 x 126	Dodecagonal con ala		TC-877	SJ-544	
BU-045	VOLKSWAGEN SEAT	GOL 1000 SAVEIRO POLO 1995/... SEAT: IBIZA 1996/... - 1.0 - AER/ALL/ AT (SOHC 8V/DOHC 16V)		10	M9 x 1,25 x 115	Dodecagonal interior con cuello y arandela		TC-720	JR-361 JR-536 JR-548 SJ-361 SJ-536	JD-361 JD-536 JD-548
BU-530	VOLKSWAGEN SEAT	GOL 1000 SAVEIRO POLO 1995/... - SEAT: IBIZA 1996/... - 1.0/1.4 AT/AER/ALL/ARR/AHW/AKQ/APE/AUA/AFK/ANM/AQQ/AUB/AXP/BBY/BCA/BBZ		10	M9 x 1,25 x 138	Dodecagonal interior con flange	036103384B	TC-720	JR-361 JR-536 JR-547 JR-549 SJ-361 SJ-536 SJ-547 SJ-549	JD-361 JD-536 JD-547 JD-549
BU-209	VOLKSWAGEN	GOLF IV FOX SURAN GOL POLO CADDY DERBY POINTER - 1,4/1,6 - AUD/AKK/AKQ/AHW/BKR/BAH/BJA/BPA		10	M9 x 1,25 x 133	Dodecagonal interior con flange y arandela		WHT001865		
BU-042	VOLKSWAGEN FORD	GOLF GOL GACEL FOX CADDY PASSAT JETTA SANTANA VAN POINTER LUPO GACEL SENDA CARAT POLO VENTO CLASSIC DERBY GALAXY ESCORT - 1,5/1,6/1,8/2,0 - ZC/YJ/FL/FB/FD/FH/FK YN/YP/YH/YT/Y5 VY/VZ/YW/YN/EM/FS/FT/FR/FN/FP/WP/WY/WV AP AUDI 827 ABA/AKR/ATU/AWF/AWG/AGG		10 10	M11 x 1,5 x 98 Arandelas A11,5 x 21,5 x 4H	Dodecagonal interior con cuello y arandela	049103384B 049103385 050103384	TC-363 TC-434-15 TC-456 TC-497 TC-600	JR-302-15 JR-326-15 JR-360-15 JR-453-15 JR-461 SJ-240 SJ-241 SJ-266 SJ-453 SJ-461	JD-129-15 JD-130-15 JD-171-15 JD-453-15 JD-461
BU-049	VOLKSWAGEN	GACEL SENDA SANTANA GOL CARAT POLO CLASSIC FOX POINTER LUPO DERBY - 1,6/1,8 - AP		10	M11 x 1,5 x 106	Dodecagonal interior con flange		TC-497	JR-326-15 SJ-241	JD-130-15
BU-229	VOLKSWAGEN SEAT	BORA CADDY GOLF JETTA NEW BEETLE PASSAT POLO SHARAN TOURAN - SEAT: ALHAMBRA ALTEA CORDOBA IBIZA LEON TOLEDO - 1.6/2.0 - AEH/AHL/AKL/ALZ/ANA/APF/ARM/AUR/AVU/ AWH/AYD/BFQ/BFS/BSE/BSF/AEG/APK/AQY/ATM/AZG/AZH/AZM/BBX/BEH/BER/BHP/BHY/BSX		10	M10 x 1,50 x 120	Spline interior con ala y arandela		TC-697 TC-816-15	JR-338-15 JR-475-15 SJ-338	JD-338-15 JD-475-15
									SJ-475	

TORNILLOS PARA CULATA DE CILINDROS (BU) Parafusos de Cabeçote / Cylinder Head Bolts

 Ordenado por cm³ / Ordenados pelo cm³
 Arranged by cm³

Unidad de empaque / Unidade de Embalagem / Packaging Unit: X Juego x Jogo / x Set

CODIGO	MARCA	DESCRIPCION	COMB.	CANT	MEDIDAS	CABEZA	N° ORIGINAL	JUEGOS EN LOS QUE APLICA		
								TC	JR / SJ	JD
BU-228	VOLKSWAGEN SEAT	BORA GOLF IV PASSAT POLO NEW BEETLE SHARAN VARIANT - SEAT: ALHAMBRA CORDOBA EXEO IBIZA LEÓN / T TOLEDO 4 CIL. 20V - 1.8 - APG/AUM/ARX/AUQ/AWU/AMK/AWT/AJQ/APX/APP/ARY/APH/AVC/ARZ/AWM/AWC/AWP/AWV/ATC/AMU/AQA/AYP/AJH/AUG/AWW/BBU/BJX/BKF		10	M10 x 1,50 x 120	Spline interior con cuello 		TC-815	JR-517-15	JD-517-15
BU-044	VOLKSWAGEN SEAT	GOL POLO PASSAT VENTO GOLF IBIZA CORDOBA TOLEDO - 1,6/1,8 - IF AFT/ADZ		10 10	M11 x 1,5 x 110 Arandelas A11,5 x 21,5 x 4H	Dodecagonal interior 	0491033853 032103384	TC-498	JR-510	JD-510
BU-043	VOLKSWAGEN	SENDA SAVEIRO GOL CADDY GOLF PASSAT KOMBI SANTANA POLO GOLF CADDY PASSAT VENTO TRANSPORTER - 1,6/1,9 - CR/JK/DR/JF/C5 1Y/X AAZ	<i>Diesel</i>	10	M12 x 1,75 x 115	Dodecagonal interior con arandela 	068103384A	TC-527-20	SJ-242	JD-148-ST
BU-050	VOLKSWAGEN	POLO GOLF CADDY PASSAT VENTO TRANSPORTER - 1,9 - 1Y/X AAZ	<i>Diesel</i>	10	M12 x 1,75 x 110	Dodecagonal interior con flange 		TC-652	SJ-271	JD-173-ST
BU-237	VOLKSWAGEN	AMAROK TDI 16V CRAFTER - 2.0 - CDBA CDCA CKT/C CKUB/C CNEA/FA/FB CSHA	<i>Diesel</i>	10	M12 x 1,75 x 137	Dodecagonal interior con punta piloto 		TC-355-MG	SJ-596	JD-596-ST
BU-136	VOLKSWAGEN PEGASO VOLVO	LT28 LT31 LT35 LT40 LT45 LT50 LT55 EKUS 75/100 244 245 260 740 760 780 940 D/TD - 2,4 - CP/DV/DW/1G/1S/ACL/DL/HS/1E/D24/T/TD/TIC	<i>Diesel</i>	14	M12 x 1,75 x 115	Dodecagonal interior con arandela 	068103384A			
BU-137	VOLKSWAGEN	TRANSPORTER T4/TDI 5 CILINDROS MULTIVAN CALIFORNIA CARAVELLE EUROVAN LT - 2,4/2,5 - AAB/AJA/ACV/AGX/AHD/AJT/AAF/ACU/AEN/AET/AEU/APL	<i>Diesel</i>	12	M12 x 1,75 x 115	Dodecagonal interior con arandela 	068103384A			

ILLINOIS®

INFORMACIÓN
TÉCNICA

ESP

INFORMAÇÃO
TÉCNICA

PORT

TECHNICAL
INFORMATION

ENG

JUNTA CULATA DE CILINDROS INSTRUCCIONES PARA EL CORRECTO MONTAJE

DESMONTAJE

Dejar enfriar el motor a temperatura ambiente, luego quitar el tapón del vaso de expansión del circuito de refrigeración y con el motor en seco aflojar los tornillos en el orden inverso al apriete.

LIMPIEZA

Limpiar perfectamente las superficies de contacto entre la tapa de cilindros y el block. Cuide especialmente de no dañarlas provocando ralladuras, esta operación puede ser realizada utilizando Tricloroetileno o Thinner; luego limpiar el circuito de refrigeración. Con un macho limpiar las roscas del block, con una mecha o avellanador limpiar los agujeros pasantes de la tapa para eliminar rebabas. Aspirar mediante una jeringa toda suciedad, agua o aceite que pueda hallarse en el fondo de los orificios, luego utilice aire comprimido para eliminar todo resto de suciedad producto del maquinado y evitar así un falso ajuste de la tapa de cilindros. Proteja sus ojos, utilice lentes de seguridad.

VERIFICACIONES

Comprobar que la planitud de la tapa y block se encuentre dentro de las tolerancias admitidas:

Motores de 4 cilindros y V8: máximo 0.05mm (0.002”).

Motores de 6 cilindros: máximo 0.127mm (0.005”).

Motores diesel: consultar especificaciones de fábrica, ya que varía según el modelo y las tolerancias aplicadas.

En el caso de tapas de cilindros que se encuentren muy distorsionadas, (lo cual implicaría un excesivo rectificadas fuera de los valores admitidos por el fabricante) pruebe de realizar un “rectificado” por calor, donde la tapa es calentada en un horno especial abulonado a una placa pesada de acero y suplementando en los lugares de mayor deformación. Este trabajo debe ser realizado en talleres especializados que cuentan con la tecnología necesaria para esta delicada operación.

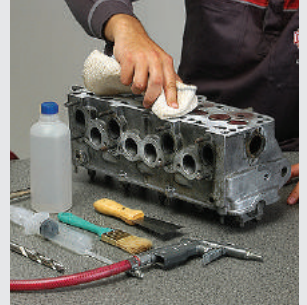

Comprobación de la rugosidad de los planos de block y tapa de cilindros:

RUGOSIDAD	JUNTA «SÁNDWICH»	JUNTA METALGRAF® Y MULTILÁMINAS
Tapa o Block de Aluminio	2,3 um (máximo)	0,5 / 1,0 um
Tapa o Block de Fundición	3,8 um (máximo)	1,5 / 1,8 um

La suavidad que presentan las superficies es un factor crítico en el caso de las juntas de láminas metálicas y multiláminas. Si las superficies de los planos son demasiado rugosas, la junta no podrá rellenar las rayas que presentan el maquinado de éstas, ocasionando fugas de compresión y/o líquido refrigerante y lubricante.

Utilice un rugosímetro de comparación superficial para verificar la rugosidad de los planos.

CONSEJO: Como regla general, si se desmonta la tapa de cilindros de un motor equipado con una junta de lámina y la reparación es sólo de la parte superior (es decir, el block no es desmontado), al momento de realizar el armado utilice una junta tipo "METALGRAF®", ya que ésta absorberá mejor las diferencias que pueda tener el plano del block. En la elección de la junta considere la variación de la relación de compresión.

Compruebe que la tapa de cilindros no este excesivamente rectificadas, una junta por si misma no puede compensar esta diferencia de altura (en ciertos casos pueden tocar las válvulas contra el pistón o incrementarse en exceso la relación de compresión); si esto ocurriese consulte por juntas especiales en sobremedida o reforzadas.

Recuerde que la disminución en la cámara de combustión provocará aumentos de temperatura y presión, sometiendo a esfuerzos a los componentes del motor, para los que no han sido diseñados.

La junta de tapa de cilindros actúa en estos casos como “fusible” del motor siendo esta la parte que primero se resiente. Si esto no ocurriese, pronto se provocarían graves desperfectos en el motor, como ser la perforación de los pistones causado por las detonaciones (“pistoneo”), válvulas quemadas, roturas de aros, desalineación de bielas, etc.

En caso de motores diesel, medir con un comparador la saliente de los pistones con respecto al plano del block, la medida más alta obtenida es la que se tomará como referencia; en base a esta medida seleccione el espesor de la junta (muestras).

IMPORTANTE: Verificar el espesor de la junta usada (de ser posible con un micrómetro) con la nueva a utilizar. En la elección de la junta no tenga en cuenta únicamente las muescas que identifican los espesores (motores diesel), la nueva junta debe tener aproximadamente entre un 4% a un 8% más de espesor que la junta usada.

Controle los tornillos de apriete de la tapa de cilindros. En motores que se indique el apriete por kilos, verifique que la longitud corresponda a la medida original, si se observa que se encuentran “estirados” o la superficie de la rosca dañada, DESCARTELOS.

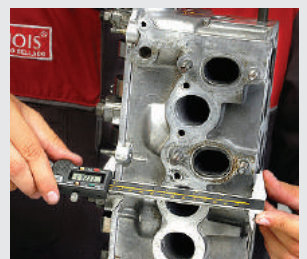

En caso de reutilizarlos cepille la rosca; lubricar ligeramente y dejar escurrir unos 30'. Esta medida permite disminuir la pérdida de torque por rozamiento en la rosca del tornillo haciendo más efectivo el par indicado. Si el tornillo tiene arandela integrada, lubricar entre la arandela y la cabeza del tornillo. **ATENCIÓN!!!** Nunca lubricar la cara de la arandela contra la culata. Si se observa que los tornillos son de diferentes longitudes, cuide especialmente de respetar la posición correcta de cada uno; de no hacerlo podría provocar un falso apriete y la tapa de cilindros no apoyará correctamente en el block. Nunca utilizar diferentes tipos de bulones mezclados, ya que los materiales y diseños pueden ser distintos.

En motores que se indique el apriete angular **ES IMPRESCINDIBLE** utilizar arandelas y tornillos **NUEVOS!!!**.

En motores con camisas húmedas intercambiables, debe verificarse la correcta saliente de las mismas con respecto al plano del block. Determine el espesor del "suplemento" de asiento de camisa y recuerde que sólo debe colocarse uno por camisa.

Utilice comparador y adécuese a las tolerancias especificadas por el fabricante. Es muy importante que las camisas se coloquen en posición de forma tal que la saliente se escale desde el cilindro N° 1 hacia el cilindro N° 4 o viceversa.

MONTAJE

No aplicar ningún producto adicional a la junta de tapa de cilindros (siliconas, grasas, selladores) debido a que se estaría provocando un sobre espesor y por ende el incorrecto asentamiento de la misma. La colocación de la junta debe realizarse en seco. No se debe montar la misma junta por segunda vez; es importante realizar los ajustes con el motor frío.

El circuito de refrigeración se completará solamente luego de concluida la operación de armado.

Ajustar los tornillos de fijación de la tapa de cilindros siguiendo el orden y sistema indicado por el fabricante.

IMPORTANTE: En la mayoría de los motores modernos se especifican diferentes torques para los tornillos, dependiendo de su ubicación en la tapa; al igual que el sistema de apriete empleado, debido que en ocasiones para el correcto asentamiento de la tapa en el block no se utiliza el tradicional sistema en cruz o en espiral.

Poner en marcha el motor ("sin exigirlo") hasta que alcance la temperatura normal de trabajo. Deje enfriar a temperatura ambiente y reapriete al torque final que utilizó en la etapa anterior.

- En caso que el ajuste sea por kilos: operando tornillo por tornillo y en mismo orden que utilizó para el apriete, afloje 90° y ajuste al valor final.
- En el caso que el ajuste sea angular: utilice una llave goniométrica en lugar del torquímetro (o puede acoplarse a éste un goniómetro adaptable) para tener mayor exactitud posible de los ángulos aplicados. Debe proceder específicamente como indica el fabricante, ya que es muy variable la secuencia de ajuste para cada modelo de motor y cada tipo de tornillo empleado.

CONSEJO: En el método angular, los ajustes deben ser aplicados de una vez en forma pareja y firme. Si detiene el ajuste a medio camino o afloja la tensión que le esta aplicando antes de llegar a la posición final, es muy probable que el torque aplicado no sea el valor que especificó el fabricante. Entre los 600 y 1000 kms, al ajustar la luz final de válvulas, verifique que los tornillos no hayan perdido tensión y en el caso de ser necesario repita la última operación de ajuste (si el sistema que utilizó fue por kilos), con el motor en frío y el circuito de refrigeración vacío.

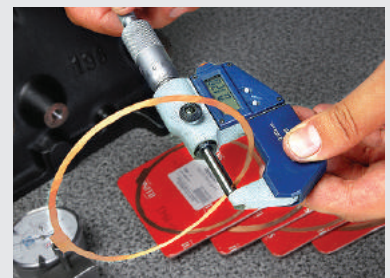
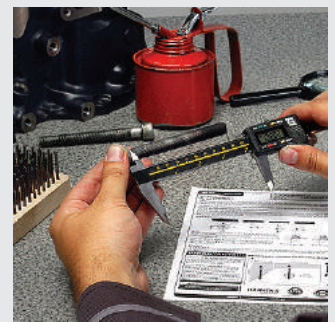
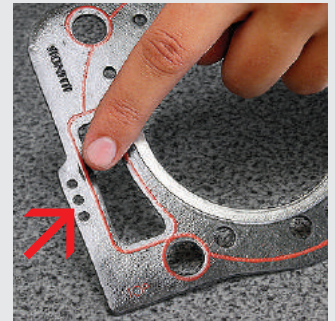

Seguir atentamente las recomendaciones de este informe y las que se acompaña en el envase del producto. Tenga en cuenta que la evolución de los motores, materiales y cambios tecnológicos han hecho que ciertos procedimientos y algunas prácticas de costumbre quedaran fuera de lugar y no sean válidas en la actualidad.

DIFERENCIAS ENTRE APRIETE POR KG. Y APRIETE ANGULAR

APRIETE POR KILOS

En el apriete por Kg. lo que medimos es la fuerza de apriete que le aplicamos al tornillo de culata para el cierre. La carga en kg. la leemos directamente de la llave (si es de dial), saltará el muelle (si la llave es de disparo), o nos indicará por medio de una luz y una señal acústica (si la llave es electrónica).

El problema que se puede plantear en el apriete por kg. deriva de las distintas escalas de medida empleadas por el fabricante del motor. Para interpretarlo mejor, pasa exactamente igual cuando se miden distancias; los países que utilizan el sistema métrico medimos las distancias en kilómetros, mientras que en Inglaterra, Estados Unidos y Australia lo hacen en millas. De la misma manera, para medir la fuerza de apriete de un tornillo tenemos tres escalas distintas:

Como en los tres sistemas lo que estamos midiendo es la fuerza que se realiza al apretar el tornillo, entre ellos encontramos equivalencias.

Volviendo al ejemplo de las distancias, si entre dos ciudades tenemos 160 km de distancia, aproximadamente equivale a unas 100 millas.

A la hora de apretar pasa algo similar:

SISTEMA DE MEDIDA	UNIDAD DE MEDIDA	COMUNMENTE SE DENOMINA
MÉTRICO	Kpm (Kilopondio por metro)	Apretar en Kilos
INGLÉS	Lb ft (Libras por pie)	Apretar en Libras
INTERNACIONAL	Nm (Newton por metro)	Apretar en Newtons

Nota:

La conversión de **Kpm a Nm.** no es exacta. La misma se debería multiplicar por 9,8, pero generalmente se multiplica por 10, ya que es más fácil y la diferencia es mínima.

PARA PASAR DE	OPERACION A REALIZAR	EJEMPLOS
NEWTONS A KILOS	DIVIDIR POR 10	35 Nm = 3,5 Kpm 70 Nm = 7 Kpm 150 Nm = 15 Kpm
KILOS A NEWTONS	MULTIPLICAR POR 10	3 Kpm = 30 Nm 5 Kpm = 50 Nm 7,5 Kpm = 75 Nm
LIBRAS A KILOS	DIVIDIR POR 7,23	51 Lb ft / 7,23 = 7,05 » 7 Kpm 80 Lb ft / 7,23 = 11,06 » 11 Kpm
KILOS A LIBRAS	MULTIPLICAR POR 7,23	3 Kpm x 7,23 = 21,69 » 22 Lb ft 5 Kpm x 7,23 = 36,15 » 37 Lb ft

Verificaciones: Controle los tornillos, en motores que se indique el apriete por kilos, verifique que la longitud corresponda a la medida original, si se observa que se encuentran "estirados", oxidados o superficie de la rosca dañada, DESCARTELOS.

En caso de reutilizarlos, cepillar la rosca; lubricar ligeramente con aceite de motor rosca y bajo cabeza; dejar escurrir unos 30'. Esta medida hace más efectivo el par indicado debido a que disminuye la pérdida de torque por rozamiento en la rosca del tornillo y evita que se deposite aceite en el fondo del orificio. Si el tornillo tiene arandela integrada, lubricar entre la arandela y la cabeza del tornillo. **ATENCIÓN!!!** Nunca lubricar la cara de la arandela contra la culata. Si se observa que los tornillos son de diferentes longitudes, cuide especialmente de respetar la posición correcta de cada uno; de no hacerlo podría provocar un falso apriete y la tapa de cilindros no apoyará correctamente en el block. Nunca utilizar diferentes tipos de bulones mezclados, ya que los materiales y diseños pueden ser distintos. En motores que se indique el apriete angular es **IMPRESINDIBLE** utilizar arandelas y tornillos nuevos!!!

LUBRICACION: LUBRICAR LIGERAMENTE ROSCA Y BAJO CABEZA, LUEGO DEJAR ESCURRIR 30'.

TORNILLO DE CULATA CON FLANGE O ALA



TORNILLO DE CULATA CON ARANDELA

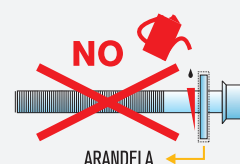
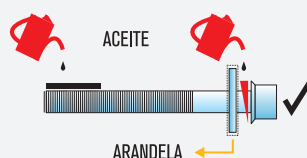

APRIETE ANGULAR

Cuando se realiza un apriete angular, lo que se mide es el giro que realiza el tornillo (o más fácil, lo que gira el mango de la llave al apretar). Para medir los grados se tiene que utilizar un goniómetro o angulímetro. Al apretar por grados siempre se empieza haciendo un pequeño apriete en kilos y luego se procede a dar los grados de apriete que indique el manual. Lo que tiene que quedar en claro es que al medir en “grados” estamos midiendo un ángulo, mientras que al medir en “kg.” lo que se está midiendo es la fuerza que se está ejerciendo. Por lo tanto, no existe equivalencia entre los grados y los kilos.

EJEMPLO:

Si roscamos dos tornillos y uno cuesta más que otro, para el que cuesta más tendremos que hacer más fuerza para roscar la misma longitud (en caso de que el apriete sea por kilos), al apretar los mismos kilos con la llave uno habrá roscado más que el otro (el que menos cuesta roscar será el que más roscado esté). Por el contrario, si por ejemplo apretamos dos tornillos a un ángulo de 90°, aunque uno cueste más que otro los dos tornillos habrán roscado por igual en el block, por lo que obtendremos un apriete más preciso.

EJEMPLOS DE APRIETE POR ANGULO:

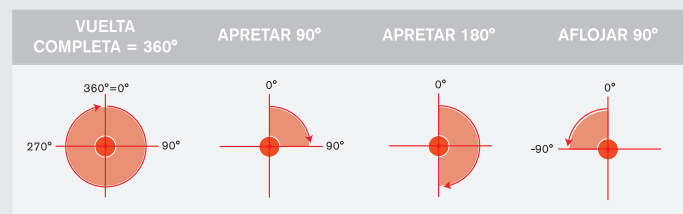

Otro dato a tener en cuenta es que los grados son acumulativos, esto es: si no podemos dar 90° en una sola etapa porque no hay espacio, podemos hacerlo en tantas etapas como querramos, siempre que al final obtengamos los 90°. Por ej., podemos en tres etapas de 30°, ya que $30° + 30° + 30° = 90°$, o en dos de 45° ($45° + 45° = 90°$);

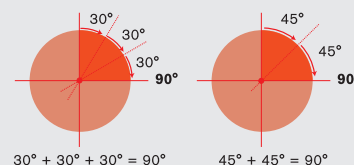

CONSEJO: En el método angular, los ajustes deben ser aplicados de una vez, en forma pareja y firme. Si detiene el ajuste a medio camino o afloja la tensión que le está aplicando antes de llegar a la posición final, es muy probable que el torque aplicado no sea el valor que especificó el fabricante.

IMPORTANTE:

En el apriete por Kg., la fuerza ejercida sobre el tornillo se encuentra dentro los límites elásticos del mismo; esto significa que cuando uno retira la fuerza aplicada, el tornillo vuelve a su longitud inicial.

El apriete angular hace trabajar al tornillo sobre la zona plástica (ver gráfico), logrando un apriete más efectivo debido a que el estiramiento provocado en esta zona es el que mantiene la fuerza y tracción. Cuando se trabaja sobre la zona plástica, el tornillo no tiene retorno y pierde memoria de su longitud inicial; quedan como comúnmente se los denomina “estirados”. El alargamiento en la zona plástica es acumulativo, lo que imposibilita la reutilización del tornillo.

RAZONES PARA CAMBIAR LOS TORNILLOS DE CULATA

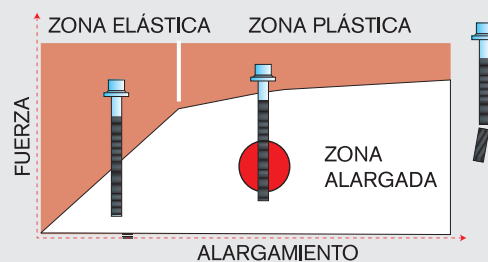

EN TODO CAMBIO DE JUNTA DE CULATA DIESEL, DEBE TENER PRESENTE LAS SIGUIENTES RECOMENDACIONES:

En la elección de la nueva junta no tenga en cuenta únicamente las “muescas” que identifican al producto, dado que cada fabricante utiliza su criterio de marcación. A efectos de mantener constante la relación de compresión, la elección del espesor de la junta se determina en función al afloramiento de los pistones con referencia al plano del block (indicado en el diagrama como Distancia “X”). Medir con un comparador la saliente de los pistones; la medida más alta obtenida es la que se tomará como referencia.

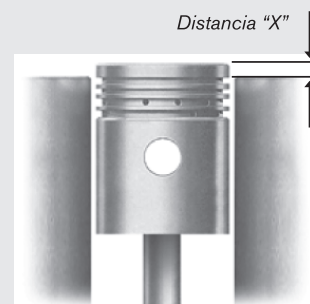

SELECCION DEL ESPESOR DE LA JUNTA (MOTORES DIESEL) *

DISTANCIA “X” EN mm.	ESPESOR	PIEZA
HASTA 0.87 mm	1.40 mm	TC-661 2M
DE 0.88 A 1.00 mm	1.50 mm	TC-662 1M
MAYOR A 1.00 mm	1.60 mm	TC-663 3M

* EJEMPLO PARA UN MOTOR RENAULT F8Q (INYECCION DIRECTA)

Para el correcto hermanamiento de las piezas debe tener presente que la junta cede aproximadamente entre un 4% y un 8% de su espesor original.

Esta referencia varía dependiendo del ajuste empleado y de la carga de material en el producto (espesor/muescas).

JUNTA DE CABEÇOTE INSTRUÇÕES DE MONTAGEM

DESMONTAGEM

Deixar o motor esfriar à temperatura ambiente, depois retirar a tampa do reservatório de água do circuito de refrigeração e, com o motor seco, soltar os parafusos na ordem inversa ao aperto.

LIMPEZA

Limpar perfeitamente as superfícies de contato entre o cabeçote e o bloco. Atenção para não danificá-las provocando ranhuras. Esta operação pode ser realizada utilizando Tricloroetileno ou Tiner; em seguida limpar o circuito de refrigeração. Com um macho roscado limpar as roscas do bloco, com uma broca ou escareador limpar os buracos de passagem do cabeçote para eliminar rebarbas. Aspirar com uma seringa toda a sujeira, água ou óleo que possa se encontrar no fundo dos orifícios, depois utilizar ar comprimido para eliminar todo o resto da sujeira que resultou do trabalho evitando, assim, um ajuste falso do cabeçote. Proteja seus olhos; utilize lentes de segurança.

VERIFICAÇÕES

Comprovar que a superfície do cabeçote e do bloco estejam planas, dentro dos limites admitidos:

Motores de 4 cilindros e V8: máximo 0,05mm (0,002").

Motores de 6 cilindros: máximo 0,127mm (0,005").

Motores diesel: consultar especificações de fábrica, uma vez que varia segundo o modelo e as tolerâncias aplicadas.

No caso de cabeçotes que se encontrem muito distorcidos, (o que implicaria em uma retificação excessiva, fora dos valores admitidos pelo fabricante) experimente realizar uma "retificação" a calor, na qual o cabeçote é aquecido em um forno especial preso com parafusos sextavados a uma placa de aço pesada e reforçada nos lugares de maior deformação. Este trabalho deve ser realizado em oficinas especializadas que contam com a tecnologia necessária para esta operação delicada.

Comprovação da rugosidade das superfícies de blocos e cabeçotes.

RUGOSIDADE	JUNTA «SANDUICHE»	JUNTA METALGRAF® E MULTILÂMINAS
Cabeçote ou bloco de alumínio	2,3 um (máximo)	0,5 / 1,0 um
Cabeçote ou bloco de fundição	3,8 um (máximo)	1,5 / 1,8 um

A suavidade que apresentam as superfícies é um fator crítico no caso de juntas de lâminas metálicas e multilâminas. Se as superfícies são muito rugosas, a junta poderá não preencher as deformações que apresentam as peças ocasionando fugas de compressão e/ou líquido de arrefecimento e lubrificante. Utilize um rugozímetro (régua) de comparação superficial para verificar a deformação das peças (cabeçote e bloco).

CONSELHO: Como regra geral, caso se desmonte a cabeçote de cilindros de um motor equipado com uma junta de lâmina e o reparo seja somente da parte superior (ou seja, o bloco não é desmontado), no momento de realizar a montagem da cabeçote utilize uma junta tipo **Metalgraf®**, uma vez que ela absorve melhor as diferenças que a superfície do bloco possa ter. Na escolha de uma junta, considere a variação da relação de compressão.

Certifique-se de que o cabeçote não esteja excessivamente retificado, uma junta por si mesma não pode compensar esta diferença de altura (em certos casos, podem tocar as válvulas contra o pistão ou aumentar em excesso a relação de compressão); caso isso ocorra, procure juntas especiais sob medida ou reforçadas.

Lembre-se que a diminuição na câmara de combustão provocará aumentos de temperatura e pressão, submetendo os componentes do motor a esforços para os quais não foram desenhados. A junta de cabeçote atua nesses casos como "fusível" do motor, sendo essa a parte que primeiro se ressent. Caso isso não ocorresse, logo se provocariam graves defeitos no motor, como por exemplo a perfuração dos pistões causada pelas detonações ("pistoneio"), válvulas queimadas, rupturas de anéis, empenamento de bielas, etc.

No caso de motores a diesel, medir com um comparador a altura máxima dos pistões com relação ao bloco; a medida mais alta será tomada como referência. Com base nessa medida, selecione a espessura da junta (travamento).

IMPORTANTE: Compare a espessura da junta usada (se possível com um micrômetro) com a nova a ser utilizada. Na escolha da junta não considere somente os travamento que identificam as espessuras (motores a diesel), a nova junta deve ter aproximadamente entre 4% e 8% a mais de espessura que a junta usada.

Controle os parafusos de aperto do cabeçote. Em motores para os quais se indique o aperto por quilos, verifique se o tamanho corresponda a medida original. Caso se observe que estão "esticados" ou que a superfície da rosca está danificada, DESCARTE-OS.

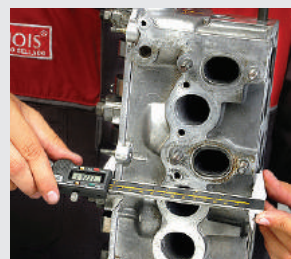

No caso de reutilizá-los, escove a rosca; lubrifique ligeiramente com óleo de motor as roscas e as superfícies de contato dos parafusos (bases das cabeças) e deixar escorrer por uns 30 minutos. Essa medida permite diminuir a perda de torque por atrito na rosca do parafuso tornando mais efetivo o par indicado. Se o parafuso tem arruela integrada, lubrificar entre a arruela e a cabeça do parafuso. **ATENÇÃO!!!:** Nunca lubrifique a face da arruela contra o cabeçote. No caso de os parafusos serem de tamanhos diferentes, atente especialmente para respeitar a posição correta de cada um; não respeitar essas posições pode provocar um aperto falso e o cabeçote não se assentará corretamente no bloco. Nunca utilize tipos diferentes de parafusos sextavados misturados uma vez que os materiais e desenhos podem ser diferentes.

Em motores para os quais se indique aperto angular **É IMPRESCINDÍVEL** utilizar arruelas e parafusos NOVOS!!!.

Em motores com camisas molhadas intercambiáveis, deve-se verificar a altura destas com relação à superfície do bloco. Determine a espessura do “suplemento” do assento da camisa e lembre-se que deve-se colocar apenas um por camisa. Utilize comparador e adéque-se às tolerâncias especificadas pelo fabricante. É muito importante que as camisas sejam colocadas em posição de forma que a altura se escalone desde o cilindro N° 1 até o cilindro N° 4 ou vice-versa.

MONTAGEM

Não aplicar nenhum produto adicional à junta de cabeçote (silicones, graxas, seladores) porque se estaria provocando uma sobreespessura e portanto o assentamento incorreto. A colocação da junta deve ser realizada a seco. Não se deve montar a mesma junta pela segunda vez; é importante realizar os ajustes com o motor frio.

O circuito de refrigeração somente será completado depois de concluída a operação de montagem.

Ajuste os parafusos de fixação do cabeçote seguindo a ordem e o sistema indicados pelo fabricante.

IMPORTANTE: em muitos motores modernos se especificam diferentes torques para os parafusos, dependendo de sua localização na cabeçote, assim como o sistema de aperto empregado, uma vez que, às vezes, para o assentamento correto da cabeçote no bloco não se utiliza o sistema tradicional em cruz ou espiral.

Dar partida no motor (“sem forçar”) até que atinja a temperatura normal de trabalho. Deixe esfriar a temperatura ambiente e reaperte ao torque final que utilizou na etapa anterior.

- Caso o ajuste seja por quilos: trabalhando com cada parafuso de uma vez e na mesma ordem que utilizou para o aperto, afrouxe 90° e ajuste ao valor final.

- Caso o ajuste seja angular: utilize um transferidor (chave goniométrica) em vez de um torquímetro (ou pode-se acoplar a ele um goniômetro adaptável) para ter a maior exatidão possível dos ângulos aplicados. Deve-se proceder especificamente como indica o fabricante, uma vez que a sequência de ajuste para cada motor e cada tipo de parafuso usado é muito variável.

CONSELHO: No método angular os ajustes devem ser aplicados de uma vez de forma igual e firme. Caso se interrompa o ajuste na metade do caminho ou se afrouxe a tensão que se está aplicando antes de chegar à posição final é muito provável que o torque aplicado não seja o valor especificado pelo fabricante. Entre os 600 e os 1000 Km, ao ajustar a luz final de válvulas, verifique que os parafusos não tenham perdido tensão e, caso seja necessário, repita a última operação de ajuste (se o sistema utilizado foi por quilos) com o motor frio e o circuito de refrigeração vazio.

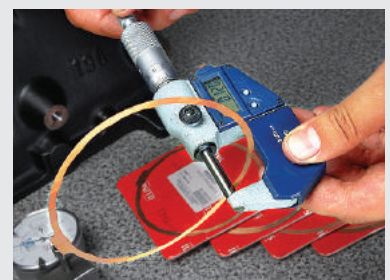
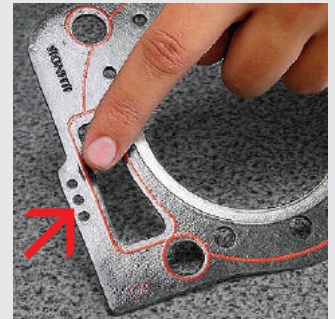
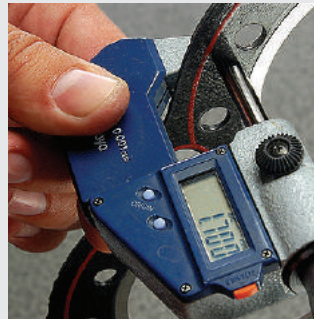

Seguir com atenção as recomendações deste relatório e as que acompanham a embalagem do produto. Considere que a evolução dos motores, materiais e alterações tecnológicas fizeram com que certos procedimentos e algumas práticas de costume ficassem ultrapassadas.

DIFERENÇAS ENTRE O APERTO POR QUILO E O APERTO ANGULAR.

APERTO POR QUILOS

No aperto por Kg, o que medimos é a força de aperto que aplicamos ao parafuso do cabeçote para o fechamento. A carga em Km é lida diretamente no torquímetro através do «dial», a mola salta se o torquímetro for de estalo ou indic por meio de luz e de sinal acústico se for eletrônico.

O problema que se pode levantar no aperto por kg são as diferentes escalas de medida dependendo do fabricante do motor. Para que o compreendamos, é exatamente a mesma coisa que acontece quando medimos distâncias; os países que utilizam o sistema métrico medem as distâncias em quilômetros, enquanto que na Inglaterra, nos Estados Unidos e na Austrália a medida é em milhas. Da mesma forma, para medir a força do aperto de um parafuso temos três escalas diferentes:

Como nos três sistemas o que estamos medindo é a força que se faz ao apertar o parafuso, entre eles existe uma equivalência.

Voltando ao exemplo das distâncias, se entre duas cidades temos 160 km de distancia, esse valor equivale a umas 100 milhas.

No momento de apertar acontece algo semelhante:

Observação:

a conversão de **Kpm a Nm** não é exata; deveríamos multiplicar por 9,8, mas geralmente se multiplica por 10, uma vez que é mais fácil e a diferença é mínima.

SISTEMA DE MEDIDA	UNIDADE DE MEDIDA	POPULARMENTE SE DENOMINA
MÉTRICO	Kpm (Quilograma-força por metro)	Apertar por Quilos
INGLÊS	Lb ft (Libras por pés)	Apertar por Libras
INTERNACIONAL	Nm (Newton por metro)	Apertar por Newtons

PARA PASSAR DE	OPERAÇÃO A REALIZAR	EXEMPLOS
NEWTONS » QUILOS	DIVIDIR POR 10	35 Nm = 3,5 Kpm 70 Nm = 7 Kpm 150 Nm = 15 Kpm
KILOS » NEWTONS	MULTIPLICAR POR 10	3 Kpm = 30 Nm 5 Kpm = 50 Nm 7,5 Kpm = 75 Nm
LIBRAS » QUILOS	DIVIDIR POR 7,23	51 Lb ft / 7,23 = 7,05 » 7 Kpm 80 Lb ft / 7,23 = 11,06 » 11 Kpm
KILOS » LIBRAS	MULTIPLICAR POR 7,23	3 Kpm x 7,23 = 21,69 » 22 Lb ft 5 Kpm x 7,23 = 36,15 » 37 Lb ft

Verificações: Controle os parafusos, nos motores em que se indique o aperto por quilos, certificando-se de que a comprimento corresponda à medida original e, caso se observe que estão “estirados”, oxidados ou com a superfície da rosca danificada, DESCARTE-OS. Caso vá reutilizá-los, escovar a rosca; lubrificar ligeiramente com óleo de motor a rosca e a base da cabeça; deixar escorrer uns 30 minutos. Esta medida torna mais efetivo o par indicado devido à diminuição da perda de torque por atrito na rosca do parafuso e evita que se deposite óleo no fundo do orifício. Caso o parafuso tenha arruela integrada, lubrificar entre a arruela e a cabeça do parafuso.

ATENÇÃO: nunca lubrifique a face da arruela contra o cabeçote. Caso se observe que os parafusos são de tamanhos diferentes tome cuidado especial para respeitar a posição correta de cada um. A falta desse cuidado poderia provocar um aperto falso e o cabeçote não se apoiará corretamente no bloco. Nunca utilize tipos de parafusos sextavados misturados, uma vez que os materiais e desenhos podem ser diferentes. Em motores nos quais seja indicado o aperto angular, é IMPRESCINDÍVEL utilizar arruelas e parafusos novos!!!

LUBRIFICAÇÃO: LUBRIFICAR LIGEIRAMENTE A ROSCA E A BASE DA CABEÇA E DEPOIS DEIXAR ESCORRER POR 30'.

PARAFUSO DE CABEÇOTE COM FLANGE OU ABA



PARAFUSO DE CABEÇOTE COM ARRUELA

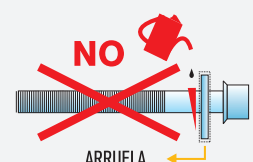
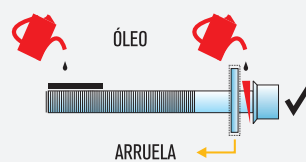

APERTO ANGULAR

Quando se realiza um aperto angular, o que se mede é o giro que realiza o parafuso (ou mais fácil, o que gira o cabo da chave ao apertar). Para medir os graus deve-se utilizar um goniômetro ou angulímetro. Ao apertar por graus sempre se começa fazendo um pequeno aperto em quilos e depois se dá os graus de aperto que indique o manual. O que tem que ficar claro é que ao medir em "graus" estamos medindo um ângulo, enquanto que ao medir em "kg", o que se está medindo é a força que se está exercendo. Portanto, não existe equivalência entre graus e quilos.

EXEMPLO:

Se rosqueamos dois parafusos e um seja maior do que o outro, para o maior termos que fazer mais força para rosquear a mesma distância (caso o aperto seja por quilos), ao apertar os mesmos quilos com a chave, um terá rosqueado mais que o outro (o menor será o que estará mais apertado). Por outro lado se, por exemplo, apertamos dois parafusos a um ângulo de 90°, ainda que um custe mais do que o outro, os dois parafusos ficarão rosqueados por igual no bloco, o que proporcionará um aperto mais preciso.

EXEMPLOS DE APERTO POR ÂNGULO:

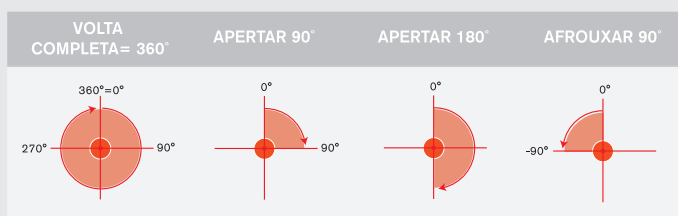

Outro dado a considerar é que os graus são acumulativos, ou seja, se não podemos dar 90° em uma única etapa porque não há espaço, podemos fazê-lo em tantas etapas quanto desejemos, sempre que, no final obtemos os 90°. Por ex., poderemos fazê-lo em três etapas de 30°, uma vez que $30° + 30° + 30° = 90°$, ou em duas de 45° ($45° + 45° = 90°$):

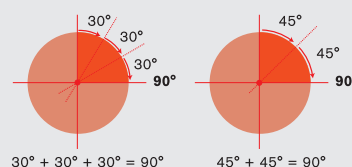

CONSELHO: No método angular os ajustes devem ser aplicados de uma vez de forma igual e firme. Caso se interrompa o ajuste na metade do caminho ou se afrouxe a tensão que se está aplicando antes de chegar à posição final é muito provável que o torque aplicado não seja o valor especificado pelo fabricante.

IMPORTANTE:

No aperto por kg, a força exercida sobre o parafuso se encontra dentro dos limites elásticos deste; isso significa que quando se retira a força aplicada, o parafuso volta ao seu tamanho inicial.

O aperto angular faz o parafuso trabalhar sobre a zona plástica (ver gráfico), conseguindo um aperto mais efetivo devido ao fato de que o estiramento provocado nesta zona é o que mantém a força e a tração. Quando se trabalha sobre a zona plástica, o parafuso não tem retorno e perde a memória de seu tamanho inicial; ficam, conforme se diz normalmente, "estirados". O comprimento na zona plástica é acumulativo, o que impossibilita a reutilização do parafuso.

MOTIVOS PARA TROCAR OS PARAFUSOS DO CABEÇOTE

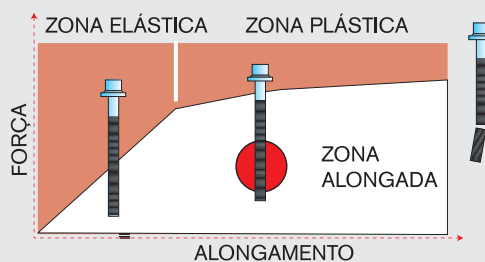

EM TODA TROCA DE JUNTA DE CABEÇOTE DIESEL, DEVESE TER EM MENTE AS SEGUINTE RECOMENDAÇÕES:

Na escolha da nova junta, não leve em consideração somente os "travamento" que identificam o produto, uma vez que cada fabricante utiliza seu critério de marcação. Para manter constante a relação de compressão, a escolha da espessura da junta se determina em função do afrouxamento dos prisioneiros com referência ao bloco (indicado no diagrama como Distância X), medido com um comparador a altura dos pistões; a medida mais alta obtida é a que se toma como referência.

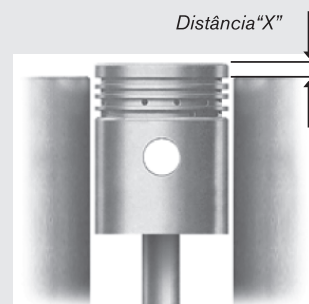

ESCOLHA DA ESPESSURA DA JUNTA (MOTOR DIESEL)*

DISTÂNCIA X EM mm.	ESPESSURA	PEÇA
ATÉ 0.87 mm	1.40 mm	TC-661 2M
DE 0.88 A 1.00 mm	1.50 mm	TC-662 1M
MAIOR QUE 1.00 mm	1.60 mm	TC-663 3M

* EXEMPLO PARA UM MOTOR RENAULT F8Q (INJEÇÃO DIRETA)

Para a correta união das peças deve-se ter em mente que a junta cede entre 4% e 8% de sua espessura original.

Esta referência varia dependendo do ajuste empregado e da carga de material no produto (espessura/travamento).

CYLINDER HEAD GASKETS INSTRUCTIONS FOR A CORRECT ASSEMBLY

DISASSEMBLY

Let the engine cool at room temperature and then take away the stopper of the expansion tank of the cooling circuit. Once the engine is dry, loosen the screws in the reverse order that will be used in tightening.

CLEANING

Clean thoroughly the contact surfaces between the cylinder heads and the block. Be careful not to scratch them. This can be done with trichloroethylene or paint thinner. Then, clean the cooling circuit. Use a male screw to clean the threads of the block and a wick to clean and eliminate burrs of the head's clearance holes. Draw all dirt, water or oil situated on the holes into a syringe and then use compressed air to clean the machine product remnants to avoid a false torque of the cylinder head. Protect your eyes with safety glasses.

CHECKINGS

Make sure that the flatness side of the head and the block are within the admitted tolerances:

Four-cylinder engines and V8: 0.05 mm max (0.002")

Six-cylinder engines: 0.127 mm max (0.005")

Diesel engines: consult manufacturer specifications since the tolerances vary according to the model.

In cases of cylinder head distortion (which imply an excessive grinding without considering the admitted tolerances) try a grinding heat treatment in which the head is heated in a special oven that is bolted to a heavy steel plate shimming the places with severe distortions. This should be done in specialized workshops that have the technology needed to do this type of work.

Verification of the block blueprint roughness and the cylinder head:

ROUGHNESS	GASKET «SANDWICH»	GASKET METALGRAF® AND MULTILAYERS
Steel block or head	2,3 um (maximum)	0,5 / 1,0 um
Cast block or head	3,8 um (maximum)	1,5 / 1,8 um

In the cases of metal layer and multi-layer gaskets, the surface softness is a critical factor. If the plane surfaces are too rough, the gasket won't be able to fill the lines of their machining thus causing compression, liquid refrigerant or lubricant leaks. Use a roughness meter to verify the roughness of the planes.

PIECE OF ADVICE: As a general rule, if a cylinder head of an engine that has a layer gasket is disassembled and only the upper section is being repaired (meaning that the block is not being disassembled), you should use a **Metalgraf®** gasket to assemble it since this will better tolerate the differences that might be in the block blueprints. When choosing a gasket, consider the variation that exists in the compression relation.

Make sure that the cylinder head is not excessively grinded. A gasket by itself can't compensate this difference in height (in some cases the valves can touch the piston or excessively increase the compression relation). If this happens, ask for special oversize or strengthened gaskets.

Remember that the reduction in the combustion chamber will cause temperature and pressure increases that will force the engine components. In these cases, the cylinder head gasket acts as an engine "fuse" since that is the first part to fail. If this didn't happen, serious engine damages would soon arise, such as drill holes in the piston caused by detonations (engine backfire), burnt valves, ring damages, cam misalignments, etc.

In diesel engines, measure with a comparator the piston projecting in comparison with the block blueprint; the highest measure is the one that will be taken as a reference. Also, use that measure to select the thickness of the gasket (notches).

IMPORTANT: Compare the thickness of the previous gasket with the one that will be used (if possible, using a micrometer). When selecting a gasket, the notches that identify thickness are important (diesel engines) but also take into account that the new joint must be approximately 4% to 8% thicker than the gasket that was previously used.

Check the tightening screws of the cylinder head. In engines that indicate torque in kilograms, check that the length matches the original measure. If it is "stretched" or the thread surface is damaged, DISCARD IT.

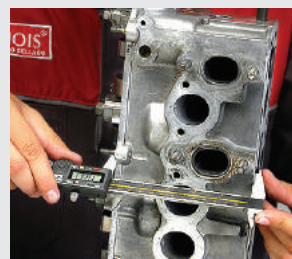

In case you reuse the screws, whisk the thread, lubricate the under head area and let drain for 30 minutes. By doing this, you diminish the loss of torque caused by the friction of the screw thread. If the screw has an integrated washer, you should lubricate within the washer and the screw head. **CAUTION!!!** Never lubricate the washer face against the head gasket. If the screws are of different lengths, respect the correct position of each one, if you don't do this, you could cause a false torque and the cylinder head will not support the block properly. Never use different types of bolts since the materials and designs can be different.

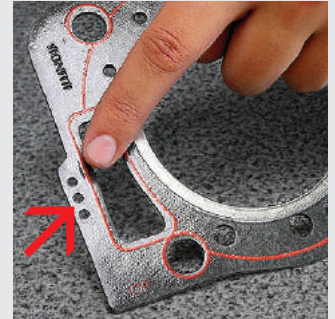

It is **ESSENTIAL** to use NEW washers and screws in engines with angular tightening.

In engines with interchangeable wet sleeves, you should check the correct projecting of them in comparison with the block blueprint. Determine the thickness of the sleeve seat "shim" and remember that you should put only one per sleeve.

Use a comparator and the tolerances specified by the manufacturer. It is very important that the sleeves are positioned in a way that the projecting is layered from cylinder No.1 to cylinder No. 4 or viceversa.

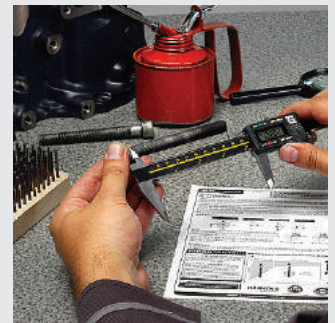

ASSEMBLY

Don't apply any additional product to the cylinder head gasket (silicone, grease, sealants) since it will cause a thickness and therefore the gasket won't settle correctly. The gasket must be dry placed. The same gasket mustn't be assembled twice, it is important to make all the adjustments when the engine is cold.

The cooling circuit will only be completed after the assembling process is finished.

Fasten the fixing screws to the cylinder head following the order and system indicated by the manufacturer.

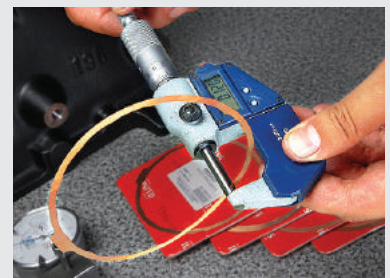

IMPORTANT: Many modern engines have different torque specifications depending on the screws head position. The tightening system is also indicated since many times the traditional cross or spiral system is incorrect for the proper settlement of the head to the block.

Start the engine (without forcing it) until it reaches a normal temperature. Let it cool to room temperature and tighten with the same final torque that was used in the previous stage.

- If the tightening is in kilograms: work on the screws one by one and in the same order that was used for the tightening, let loose 90° and tighten to the final value.

- If the tightening is angular: instead of using a torque wrench use a goniometric wrench (or a torque wrench with an adaptable goniometer) to have the best possible accuracy in the applied angles.



ADVICE: When using the angular method, the tightening must be applied all at once firm and evenly. If you stop the tightening halfway or loose the tautness that is being applied before reaching the final position, it is likely that the applied torque won't have the value specified by the manufacturer. When the tightening of the valves final lights is between 600 and 1000 km, check to ensure that the screws haven't become loose. If needed, repeat the final tightening process. Remember that if you are using the tightening in kilograms, the engine must be cold and the cooling circuit must be empty.



Follow the recommendations of this report and the ones that appear in the product packaging very carefully. Take into account that some procedures that were previously used are no longer valid because of the engines evolution, new materials and technological changes.

DIFFERENCES BETWEEN TIGHTENING IN KILOS AND ANGULAR TIGHTENING

TIGHTENING IN KILOS

In this type of tightening, we measure the torque force that is applied to the cylinder head screw used for the closure. The load in kg. appears on the wrench (if it is a dial wrench). In the case of impact wrenches, the load is indicated when the spring jumps up. In electronic wrenches, the load is indicated by a light and an acoustic signal.

The different scales used by different manufacturers might represent a problem in the tightening in kilos. To make things clear, it's like when we measure distances: there are some countries that use the metric system (km) and others that use the imperial system (miles) England, United States and Australia. The same happens when measuring the torque for a screw, we have three different scales:

As in the three systems we are measuring the torque used for tightening a screw, there is an equivalence between them. Considering the example of measuring distances again, a distance of 160 km is equivalent to 100 miles aprox.

Something similar happens when tightening:

MEASUREMENT SYSTEM	UNIT OF MEASUREMENT	IT IS FREQUENTLY REFERRED TO AS
METRIC	Kpm (Kilopond per meter)	Tightening in Kilos
ENGLISH	Lb ft (Pound per foot)	Tightening in Pounds
INTERNATIONAL	Nm (Newton per meter)	Tightening in Newtons

TO CONVERT FROM MATHEMATICAL OPERATION EXAMPLES

PARA PASSAR DE	OPERAÇÃO A REALIZAR	EXEMPLOS
NEWTONS » KILOS	DIVIDE BY 10	35 Nm = 3,5 Kpm 70 Nm = 7 Kpm 150 Nm = 15 Kpm
KILOS » NEWTONS	MULTIPLY BY 10	3 Kpm = 30 Nm 5 Kpm = 50 Nm 7,5 Kpm = 75 Nm
POUNDS » KILOS	DIVIDE BY 7.23	51 Lb ft / 7,23 = 7,05 » 7 Kpm 80 Lb ft / 7,23 = 11,06 » 11 Kpm
KILOS » POUNDS	MULTIPLY BY 7.23	3 Kpm x 7,23 = 21,69 » 22 Lb ft 5 Kpm x 7,23 = 36,15 » 37 Lb ft

Note:

The conversion of **kpm to Nm** is not exact. It should be multiplied by 9.8 but it's frequently multiplied by 10 since it's easier and it has a slight difference.

Checkings: Check the screws. In engines where the tightening must be in kilos, check that the length corresponds to the original measure, if the screws are stretched, rusty or the thread surface is damaged, **THROW THEM AWAY.**

In case you reuse the screws, whisk the thread, lubricate the under head area and the thread with engine oil and let drain for 30 minutes. By doing this, you diminish the loss of torque caused by the friction of the screw thread and avoid oil deposits in the bottom of the hole. If the screw has an integrated washer, you should lubricate within the washer and the screw head.

CAUTION!: Never lubricate the washer face against the head gasket. If the screws are of different lengths, respect the correct position of each one, if you don't do this, you could cause a false torque and the cylinder head will not support the block properly. Never use different types of bolts since the materials and designs can be different. In angular tightening engines, it is **ESSENTIAL** to use new screws and washers.

LUBRICATION: LUBRICATE THE UNDER HEAD AREA AND THE THREAD AND LET DRAIN FOR 30 MINUTES.

CYLINDER HEAD FLANGE SCREW



CYLINDER HEAD SCREW WITH WASHER



ANGULAR TIGHTENING

In the angular tightening, you measure the twist performed by the screw (or the force that twists the wrench when tightening). In order to measure the grades, you should use a goniometer or an angle meter. When tightening in grades, you always start by a small tightening in kilos and then apply the tightening grades indicated in the instruction manual. What has to be clear is that when we are measuring in grades, we are measuring the angle while when we measure in kilos we are measuring the force that is being applied. Therefore, there is no equivalence between grades and kilos.

EXAMPLE:

If we tighten two screws and one is harder than the other, we will have to use more force in order to thread the same length (if we are tightening in kilos). If we use the wrench with the same amount of kilos, one will be more threaded than the other (the one that is easier to thread). On the contrary, if we tighten two screws with a 90° angle, although one is harder to put than the other, both screws will be threaded equally therefore having a more precise tightening.

EXAMPLES OF ANGULAR TIGHTENING:

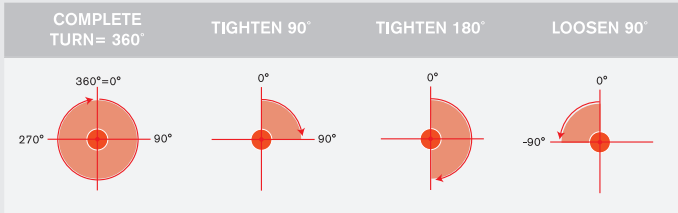

Another thing to have in mind is that grades are cumulative: if we can't turn 90° at once because there is not enough room, we can do it in stages until we reach the 90°. For example: we can have three stages of 30° since $30^\circ + 30^\circ + 30^\circ = 90^\circ$, or in two of 45° ($45^\circ + 45^\circ = 90^\circ$):

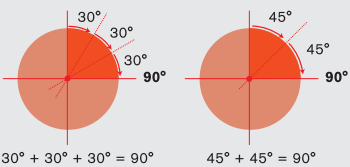

ADVICE: When using the angular method, the tightening must be applied all at once firm and evenly. If you stop the tightening halfway or loose the tautness that is being applied before reaching the final position, it is likely that the applied torque won't have the value specified by the manufacturer.

IMPORTANT:

When using the tightening in kilos, the applied force is within the elastic limits of the screws. This means that when the applied force is taken away, the screw comes back to its initial length.

The angular tightening makes the screw work on the plastic zone (see graphic) to make a more effective tightening since the stretching of the zone keeps the force and traction. When you work over a plastic zone, the screw has no way back and forgets its initial length, they end up "stretched". The stretching of the plastic zone is cumulative so it makes it impossible to reuse the screw.

REASONS TO CHANGE CYLINDER HEAD SCREWS

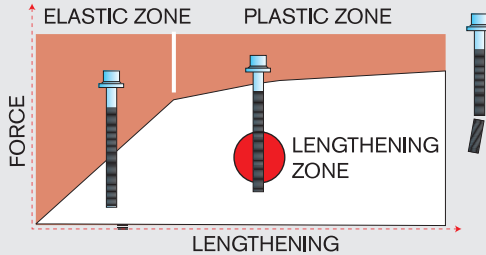

WHEN CHANGING A DIESEL CYLINDER HEAD GASKET, REMEMBER THE FOLLOWING RECOMMENDATIONS:

When selecting a new gasket, the "notches" are not the only thing to consider since each manufacturer has its own marking criteria. In order to keep the compression relation constant, the thickness of the gasket must be determined according to the loosening of the setscrews in reference with the block blueprint (indicated in the diagram as X Distance), measure the projecting of the pistons with a comparator and use the highest as reference.

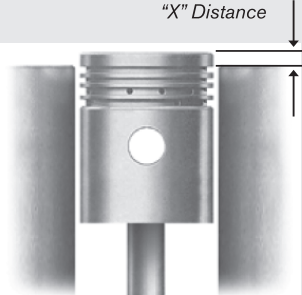

SELECTION OF THE JOINT THICKNESS (MOTOR DIESEL)*

"X" DISTANCE IN mm.	THICKNESS	PART
UP TO 0.87 mm	1.40 mm	TC-661 2M
FROM 0.88 TO 1.00 mm	1.50 mm	TC-662 1M
OVER 1.00 mm	1.60 mm	TC-663 3M

In order to have a correct coupling of the parts, bare in mind that the gasket yields between 4%- 8% of its original thickness. This reference varies depending on the applied tightening and the load of material in the product (thickness and notches).

* EXAMPLE FOR A RENAULT F8Q ENGINE (DIRECT INJECTION)



www.juntasillinois.com

Copyright © 2019 Juntas Illinois S.A. Todos los derechos reservados. Prohibida su reproducción total o parcial.
El logotipo de Illinois, TC Pro, Metal Graf, Top Grey, Top Black y ESCAPlus son marcas registradas por Juntas Illinois S.A.

Copyright © 2019 Juntas Illinois S.A. Todos os direitos reservados. Proibida sua reprodução total ou parcial.
O logotipo de Illinois, TC Pro, Metal Graf, Top Grey, Top Black e ESCAPlus são marcas registradas por Juntas Illinois S.A.

Copyright © 2019 Juntas Illinois S.A. All rights reserved. Total or partial reproduction is forbidden.
Illinois, TC Pro, Metal Graf, Top Grey, Top Black and ESCAPlus logotypes are trademarks registered by Juntas Illinois S.A.